

Important notice

Dear Customer,

On 7 February 2017 the former NXP Standard Product business became a new company with the tradename **Nexperia**. Nexperia is an industry leading supplier of Discrete, Logic and PowerMOS semiconductors with its focus on the automotive, industrial, computing, consumer and wearable application markets

In data sheets and application notes which still contain NXP or Philips Semiconductors references, use the references to Nexperia, as shown below.

Instead of <http://www.nxp.com>, <http://www.philips.com/> or <http://www.semiconductors.philips.com/>, use <http://www.nexperia.com>

Instead of sales.addresses@www.nxp.com or sales.addresses@www.semiconductors.philips.com, use salesaddresses@nexperia.com (email)

Replace the copyright notice at the bottom of each page or elsewhere in the document, depending on the version, as shown below:

- © NXP N.V. (year). All rights reserved or © Koninklijke Philips Electronics N.V. (year). All rights reserved

Should be replaced with:

- © **Nexperia B.V. (year). All rights reserved.**

If you have any questions related to the data sheet, please contact our nearest sales office via e-mail or telephone (details via salesaddresses@nexperia.com). Thank you for your cooperation and understanding,

Kind regards,

Team Nexperia

AN10909

Low V_{CEsat} transistors in medium power load switch applications

Rev. 2 — 13 March 2013

Application note

Document information

Info	Content
Keywords	NXP low V_{CEsat} transistors, performance in load switch applications
Abstract	Different low V_{CEsat} transistors in load switch applications. Evaluation of low V_{CEsat} transistor key parameters like current gain h_{FE} and collector-emitter saturation voltage V_{CEsat} with respect to power losses, and choice of base drive.



Revision history

Rev	Date	Description
2	20130313	Updated Table 3
1	20100604	Initial version

Contact information

For more information, please visit: <http://www.nxp.com>

For sales office addresses, please send an email to: salesaddresses@nxp.com

1. Introduction

This application note describes different low V_{CEsat} Breakthrough In Small Signal (BISS) transistors from NXP and other discrete semiconductor suppliers in a typical load switch application (20 V, up to 1.5 A) with respect to the parameters current gain h_{FE} and collector-emitter saturation voltage V_{CEsat} . Power losses will be discussed for different low V_{CEsat} transistor types and a guideline will be evaluated to choose the right base drive.

1.1 Introduction to low V_{CEsat} transistors

When comparing a bipolar transistor to a MOSFET, the major drawback in the past was that the bipolar transistor was a current-driven device requiring a base drive capable of continuous currents. This however was true with conventional silicon Bipolar Junction Transistors (BJT). With the high current gain h_{FE} and very low saturation voltage V_{CEsat} (on-resistance) available from modern NXP high-performance low V_{CEsat} (BISS) transistors, the power and base current requirements have been significantly reduced, making them a viable solution for low and high-voltage switching applications.

Low V_{CEsat} transistors were introduced to the industry over 10 years ago. They typically come in the range of 12 V to 100 V V_{CEO} and with collector currents up to several amperes in Surface-Mounted Device (SMD) packages like SOT23, SOT89 or SOT223.

Table 1. Parameter comparison bipolar transistors

Parameter	Conventional small-signal BJT	Low V_{CEsat} BJT (PBSS-series)
h_{FE}	~100	200 to 600
V_{CEsat} at h_{FE}	a few 100 mV	down to 30 mV

The parameter h_{FE} and V_{CEsat} both affect typical applications of bipolar transistors, like load switching or signal amplification. High current gains, for example, reduce significantly the required amount of continuous base drive, which enables designers to switch a low V_{CEsat} transistor with small currents coming directly from a μ -controller. In addition, the losses across base bias resistors and base-emitter voltage V_{BE} are significantly reduced. Low V_{CEsat} saturation voltage drops, on the other hand, reduce the power losses across the collector-emitter junction when the transistor is operated as a low-frequency switch and enables significantly higher collector current I_C capabilities on a normalized chip area.

2. Load switch circuit

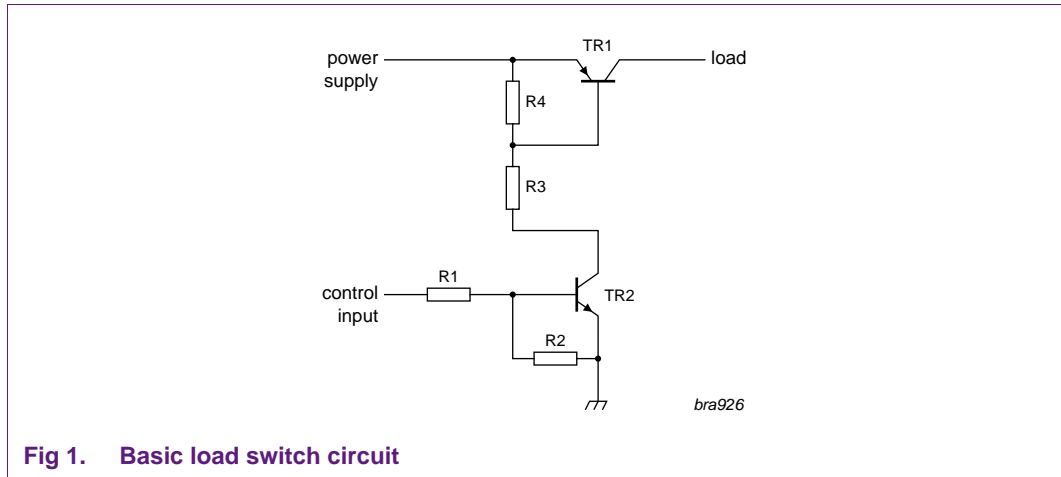

Fig 1. Basic load switch circuit

Figure 1 shows a basic load switch circuit, composed of two BJTs and their bias resistors. A small current from the control circuit, for example, a μ -controller, switches on TR2 (NPN). Then TR2 provides the necessary base current $-I_B$ to switch on TR1 (PNP). Power is delivered from source to load.

Resistors R3 and R1 set the base current for TR1 and TR2 respectively, assuming a stable input supply. They also set the desired I_C/I_B ratio called current gain. In the next section, power dissipation (P_{tot}) in the semiconductors and the resistors will be discussed, in order to give a guideline for the choice of bipolar transistor types and their necessary base drives.

2.1 Important parameter for BJTs in a load switch application

The data sheet of a semiconductor device defines maximum and typical values. The set of data sheet parameters makes it possible to compare one device to another and to make design decisions.

Besides the limiting values I_C , V_{CEO} and P_{tot} , the parameters h_{FE} and V_{CEsat} are important for the design. They define the performance of especially TR1 where most power losses occur. The control switch TR2 typically is a general-purpose transistor like a BC847 or PMBT3904, and has to deliver currents in the range of a few up to 100 mA as base drive for TR1. Typical values for h_{FE} are around 100 and V_{CEsat} is of a few 100 mV. The power loss of TR2 is only a fraction of the whole losses in the application and therefore will not be discussed further on.

TR2 is an NPN transistor and is also referred to as a low-side switch. R2 makes sure that the base is at ground with the switch open. Choosing high-ohmic values results in very small sink currents, so that the on-operation is not affected. TR1 as the high-side switch is a PNP transistor which has its base pulled to supply voltage V_{CC} via R4, while in off-condition.

We will limit the discussion of the load switch to ohmic loads and DC current so no additional drive circuits must be included (as it should be for switching inductive loads or circuits driven from AC). In order to switch DC power to an ohmic load, choose the base resistors in a way to get enough of excess base currents, making sure that the transistor is

in saturation. Saturation results in low (and deep saturation in lowest) V_{CE} drops which reduces the power losses of TR1. As saturation is dependent on excess base currents of the transistors, it affects the power losses of R3, too. Next, V_{CEsat} , the I_C/I_B ratio and the resulting power losses will be compared to the base currents in order to find the optimal working point for switching 0.5 A, 1 A and 1.5 A to an ohmic load.

2.1.1 Comparison between different low V_{CEsat} transistors in a load switch application

Different low V_{CEsat} transistors are compared in a load switch application: one in SOT223 from NXP, two SOT23 from NXP, and two from competitive semiconductor suppliers (Y and Z), both in SOT23 package. The two competitor devices are the closest crosses to the NXP portfolio in SOT23 as available in the market today.

The basis of the comparison is the cost-efficient SOT23 package in order to show the cost and space-saving opportunities when using low V_{CEsat} transistors. In addition, also a device in SOT223 is included whereas it is provided that with the bigger package also more silicon is used, naturally resulting in higher performance, but at higher costs.

The data sheets limit all of the parts to 20 V V_{CEO} whereas the collector current I_C limits are different. The I_C -limit strongly depends on the silicon technology and on V_{CEsat} and h_{FE} performance. Besides, important and often neglected factors are different specification guidelines and measurement conditions at the supplier side, resulting in different values in the data sheets. In this section, we compare the real power losses of the load switch with 0.5 A to 1.5 A load current based on SPICE simulations.

Table 2. Device list

Type number	Breakdown voltage V_{CEO} (V)	Maximum current I_{CM} (A)	Package
PBSS5320T	20	3	SOT23
PBSS302PZ	20	5.5	SOT223
PBSS4021PT	20	3.5	SOT23
Competitor Y	20	2	SOT23
Competitor Z	20	4	SOT23

The following simulation results either show V_{CEsat} characteristics of the switching device TR1 or power losses of TR1 in comparison to power losses of TR1 plus the losses of resistor R3 (TR1 base resistor). The graphs allow comparing the performance of different devices and finding an optimum working point - especially for the base drive I_B . The losses in the base resistor R3 are taken into account as in some applications the P_{tot} of the whole circuit is more important than optimizing the P_{tot} of the semiconductor switch.

The graphs were generated using the SPICE models as provided on the web pages of the suppliers.

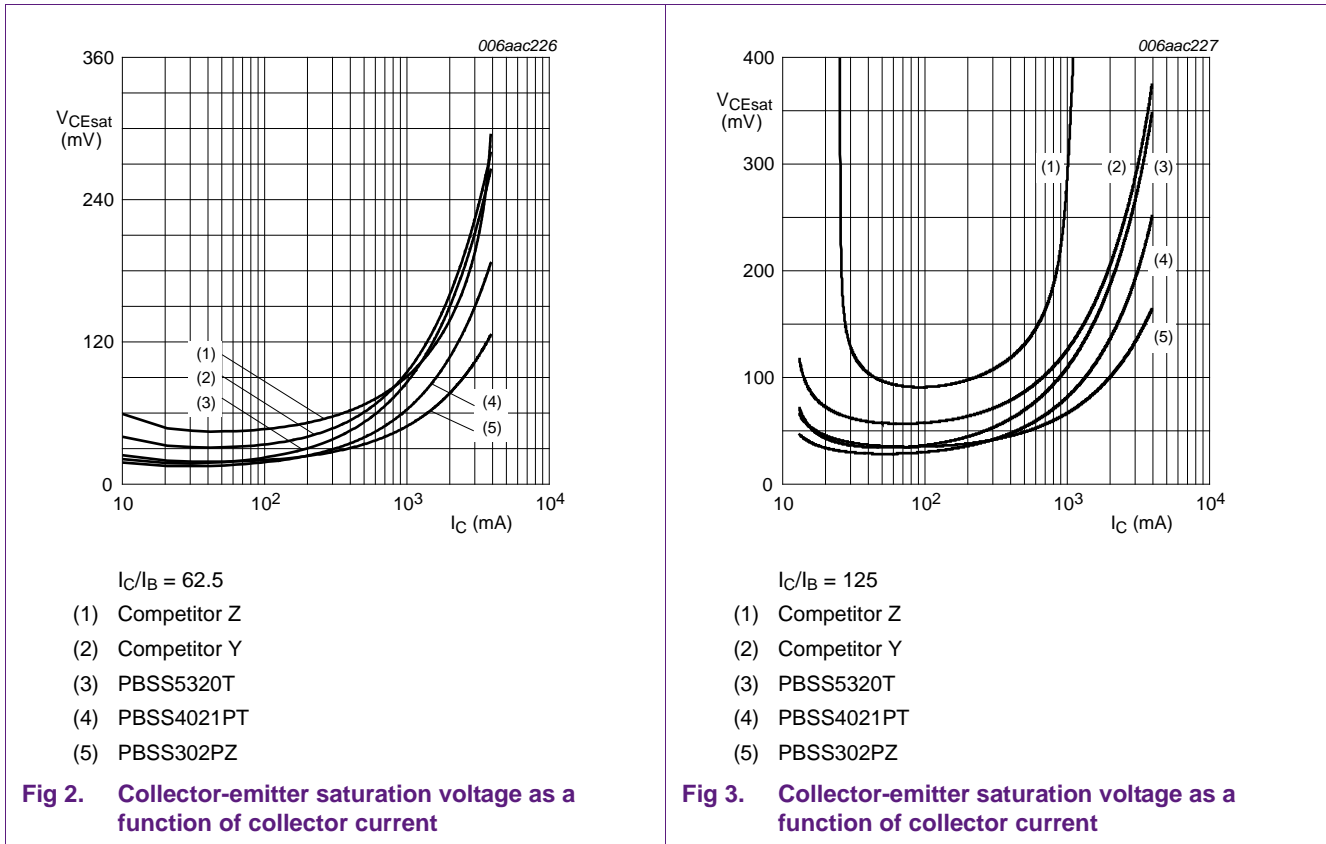
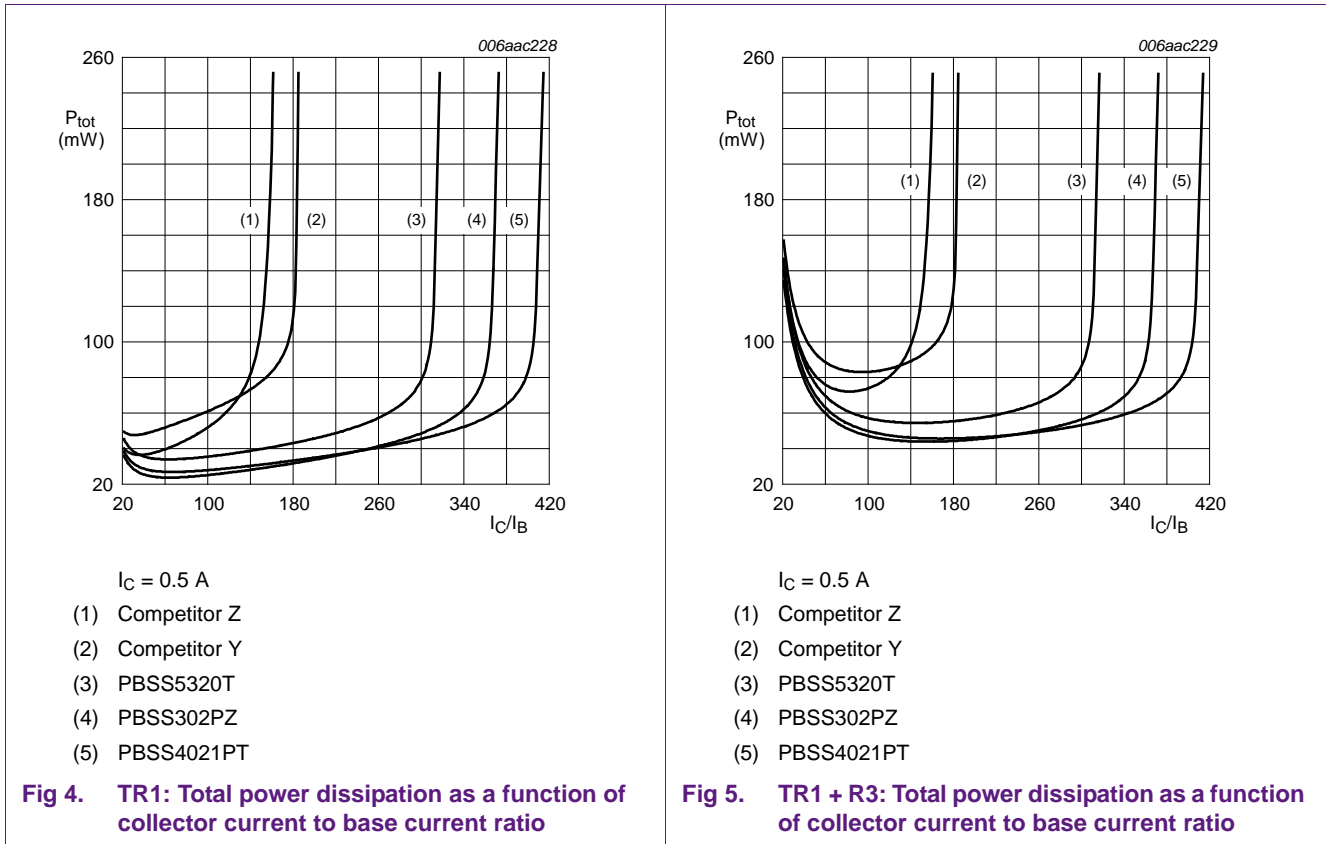

Figure 2 and Figure 3 show V_{CEsat} characteristics as a function of collector current I_C . The smaller the I_C/I_B ratio (high I_B current), the deeper the transistor is in saturation, and the lower the voltage drop across the collector-emitter junction V_{CEsat} . Deep saturation results in lowest V_{CEsat} drops which corresponds directly to the on-resistance of the device R_{CEsat} (or R_{DSon} in a MOSFET). At high collector currents I_C , the needed base drive for acceptable low V_{CEsat} values accounts for an increase of the total power losses in the application. On one hand the current gain h_{FE} drops at high collector currents and, therefore, more base current I_B is needed (refer to an h_{FE} curve of a BJT data sheet). On the other hand, V_{CEsat} increases with higher collector currents leading to higher losses.

In the first part of a V_{CEsat} characteristic, the V_{CEsat} value is mainly determined by recombination effects of the semiconductor (curve nearly flat, see Figure 2). In the second part, ohmic contributions of the package and bond wires account for a slow increase. The third part is dominated by injection effects resulting in a steep increase. The higher the I_C before injection occurs, the better the performance, especially at higher h_{FE} values.

A high-performance device gives the user more flexibility in choosing h_{FE} and I_C and reduces the needed amount of silicon, package outlines and therefore costs.



At 0.5 A load current, [Figure 4](#) and [Figure 5](#) show that with NXP high-performance silicon (for example, latest low V_{CEsat} generation PBSS4021PT), the power dissipation improves of about 25 %, compared to a conventional low V_{CEsat} device from NXP (PBSS5320T). The total power dissipation of the system (here P_{tot} of transistor TR1 and its base resistor) shows less improvement because the power dissipation in the base resistor does not change assuming the same I_C/I_B ratio. But still, overall system efficiency improves of about 17 %, and the designer is able to choose operating points with much lower base drives.

In the [Figure 4](#) and [5](#) also an SOT223 low V_{CEsat} transistor is shown (PBSS302PZ) to prove that the latest NXP low V_{CEsat} transistor generation (here PBSS4021PT) can compete with much bigger dies in medium power packages.

The optimum working point regarding the total power losses (P_{tot} (TR1) plus P_{tot} (R3)) is found at an I_C/I_B ratio of about 120 with NXP low V_{CEsat} transistors.

For both competitor devices, much more base current must be spent in order to reach an acceptable level of performance. However, this will still not reach the performance of NXP PBSS series.

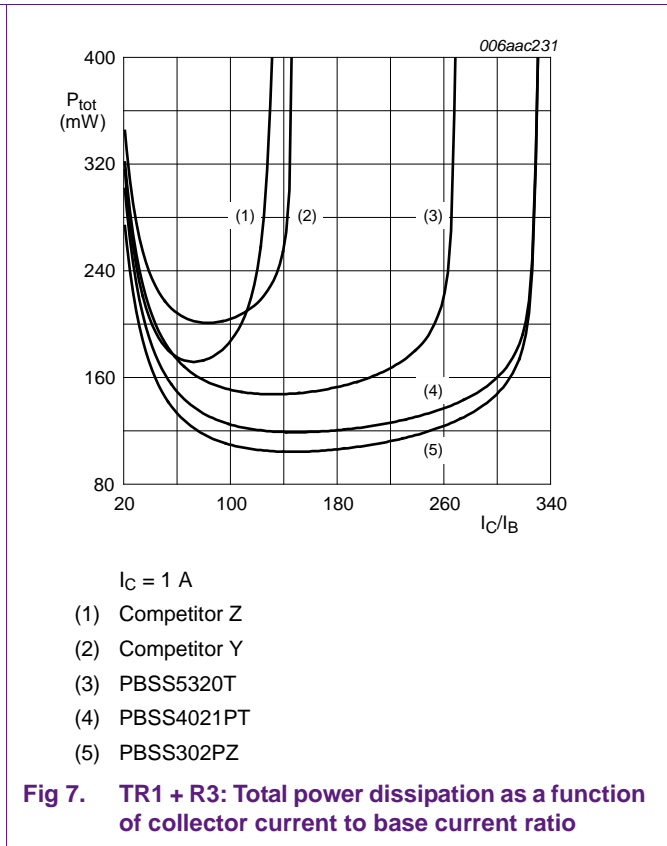
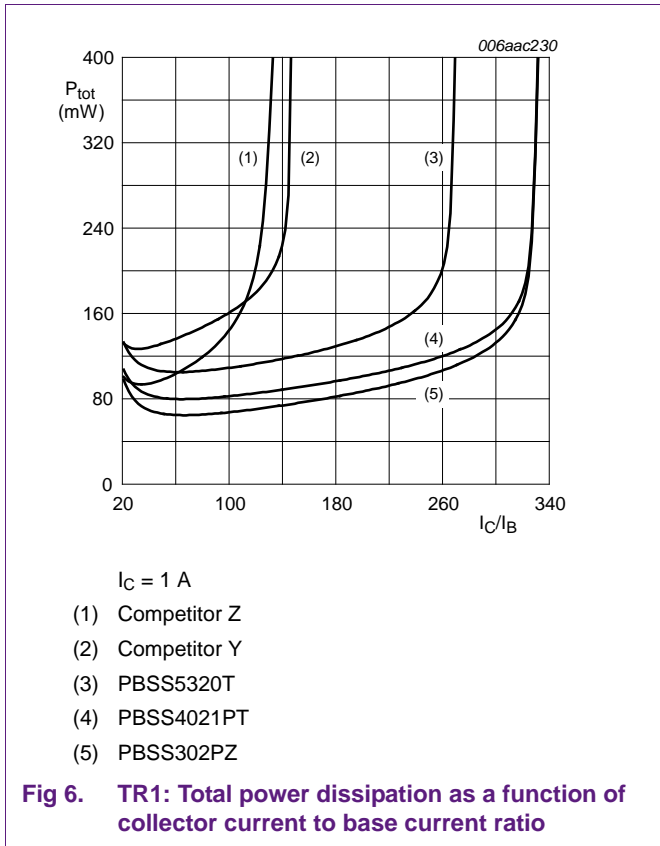

At 1 A load current, the optimum I_C/I_B ratio for lowest power dissipation in the load transistor is of about 65 for NXP devices resulting in about 15 mA TR1 base drive (or TR2 I_C current).

An I_C/I_B ratio of about 150 optimizes the power dissipation of the system TR1 plus R3, still with only less than 90 mW P_{tot} and only 6.66 mA base drive in the example of TR1 = PBSS4021PT (SOT23 package). Remember this is a 1 A application.

The two competitor devices chosen here are not able to follow the performance at I_C/I_B ratios greater than 50. Taking a maximum P_{tot} of 250 mW to 300 mW for a SOT23-sized device into account, typical competitor devices can only work with significant heat sinks and high losses in their base bias resistors (high base currents I_B for TR1).

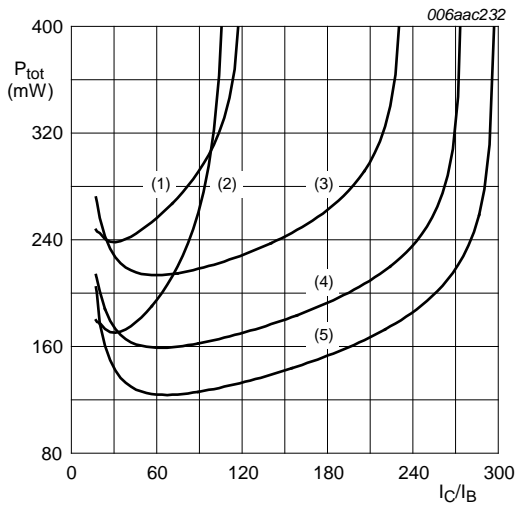

- $I_C = 1.5\text{ A}$
- (1) Competitor Y
 - (2) Competitor Z
 - (3) PBSS5320T
 - (4) PBSS4021PT
 - (5) PBSS302PZ

Fig 8. TR1: Total power dissipation as a function of collector current to base current ratio

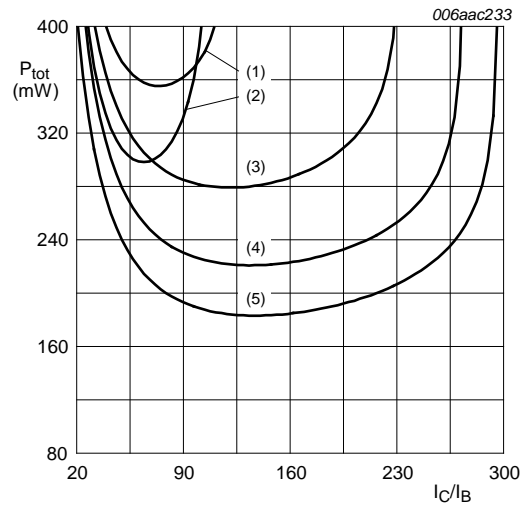

- $I_C = 1.5\text{ A}$
- (1) Competitor Y
 - (2) Competitor Z
 - (3) PBSS5320T
 - (4) PBSS4021PT
 - (5) PBSS302PZ

Fig 9. TR1 + R3: Total power dissipation as a function of collector current to base current ratio

At 1.5 A load current, the optimum I_C/I_B ratio for lowest power dissipation in the load transistor is of about 60, for the whole system 130 with NXP transistors. At $I_C/I_B = 130$, the base current I_B is of about 12 mA resulting in a 5 V application in about 50 mW power dissipation in TR1's base resistor R3.

3. Summary

The performance of a bipolar transistor in a load switch application strongly depends on V_{CEsat} and h_{FE} at desired load currents. The latest generation of NXP low V_{CEsat} (BISS) transistors offers outstanding values in both, with a typical h_{FE} of 200 to 400 and V_{CEsat} values significantly below 100 mV at high collector currents. For applications with requirements below 500 mA, even 35 mV V_{CEsat} and less is possible which actually is comparable to modern typical trench MOSFETs.

Lower power dissipation and lower heat generation allow designing highly efficient circuits and supporting the demand towards miniaturization in many of today's consumer products. NXP's low V_{CEsat} platform supports the needs towards cost-efficient bipolar low V_{CEsat} transistors leading the market in technology and performance.

Table 3. Low V_{CEsat} (BISS) transistors in DFN2020-3 and SOT23 for load switching

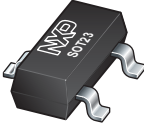
Type number	V_{CEO} (V)	Polarity	I_C (A)	$R_{CEsat(typ)}$ (m Ω) at I_C ; $I_C/I_B = 10$	Package
PBSS4620PA	20	NPN	6	46	 DFN2020-3
PBSS5620PA	-20	PNP	-6	39	
PBSS4560PA	60	NPN	6	48	
PBSS5560PA	-60	PNP	-5	90	
PBSS8510PA	100	NPN	5.2	65	
PBSS9410PA	-100	PNP	-2.7	166	
PBSS4021NT	20	NPN	4.3	36	 SOT23
PBSS4021PT	-20	PNP	-3.5	55	
PBSS4041NT	60	NPN	3.8	45	
PBSS4041PT	-60	PNP	-2.7	80	

4. Legal information

4.1 Definitions

Draft — The document is a draft version only. The content is still under internal review and subject to formal approval, which may result in modifications or additions. NXP Semiconductors does not give any representations or warranties as to the accuracy or completeness of information included herein and shall have no liability for the consequences of use of such information.

4.2 Disclaimers

Limited warranty and liability — Information in this document is believed to be accurate and reliable. However, NXP Semiconductors does not give any representations or warranties, expressed or implied, as to the accuracy or completeness of such information and shall have no liability for the consequences of use of such information. NXP Semiconductors takes no responsibility for the content in this document if provided by an information source outside of NXP Semiconductors.

In no event shall NXP Semiconductors be liable for any indirect, incidental, punitive, special or consequential damages (including - without limitation - lost profits, lost savings, business interruption, costs related to the removal or replacement of any products or rework charges) whether or not such damages are based on tort (including negligence), warranty, breach of contract or any other legal theory.

Notwithstanding any damages that customer might incur for any reason whatsoever, NXP Semiconductors' aggregate and cumulative liability towards customer for the products described herein shall be limited in accordance with the *Terms and conditions of commercial sale* of NXP Semiconductors.

Right to make changes — NXP Semiconductors reserves the right to make changes to information published in this document, including without limitation specifications and product descriptions, at any time and without notice. This document supersedes and replaces all information supplied prior to the publication hereof.

Suitability for use — NXP Semiconductors products are not designed, authorized or warranted to be suitable for use in life support, life-critical or safety-critical systems or equipment, nor in applications where failure or malfunction of an NXP Semiconductors product can reasonably be expected to result in personal injury, death or severe property or environmental damage. NXP Semiconductors and its suppliers accept no liability for inclusion and/or use of NXP Semiconductors products in such equipment or applications and therefore such inclusion and/or use is at the customer's own risk.

Applications — Applications that are described herein for any of these products are for illustrative purposes only. NXP Semiconductors makes no representation or warranty that such applications will be suitable for the specified use without further testing or modification.

Customers are responsible for the design and operation of their applications and products using NXP Semiconductors products, and NXP Semiconductors accepts no liability for any assistance with applications or customer product design. It is customer's sole responsibility to determine whether the NXP Semiconductors product is suitable and fit for the customer's applications and products planned, as well as for the planned application and use of customer's third party customer(s). Customers should provide appropriate design and operating safeguards to minimize the risks associated with their applications and products.

NXP Semiconductors does not accept any liability related to any default, damage, costs or problem which is based on any weakness or default in the customer's applications or products, or the application or use by customer's third party customer(s). Customer is responsible for doing all necessary testing for the customer's applications and products using NXP Semiconductors products in order to avoid a default of the applications and the products or of the application or use by customer's third party customer(s). NXP does not accept any liability in this respect.

Export control — This document as well as the item(s) described herein may be subject to export control regulations. Export might require a prior authorization from competent authorities.

Evaluation products — This product is provided on an "as is" and "with all faults" basis for evaluation purposes only. NXP Semiconductors, its affiliates and their suppliers expressly disclaim all warranties, whether express, implied or statutory, including but not limited to the implied warranties of non-infringement, merchantability and fitness for a particular purpose. The entire risk as to the quality, or arising out of the use or performance, of this product remains with customer.

In no event shall NXP Semiconductors, its affiliates or their suppliers be liable to customer for any special, indirect, consequential, punitive or incidental damages (including without limitation damages for loss of business, business interruption, loss of use, loss of data or information, and the like) arising out of the use of or inability to use the product, whether or not based on tort (including negligence), strict liability, breach of contract, breach of warranty or any other theory, even if advised of the possibility of such damages.

Notwithstanding any damages that customer might incur for any reason whatsoever (including without limitation, all damages referenced above and all direct or general damages), the entire liability of NXP Semiconductors, its affiliates and their suppliers and customer's exclusive remedy for all of the foregoing shall be limited to actual damages incurred by customer based on reasonable reliance up to the greater of the amount actually paid by customer for the product or five dollars (US\$5.00). The foregoing limitations, exclusions and disclaimers shall apply to the maximum extent permitted by applicable law, even if any remedy fails of its essential purpose.

4.3 Trademarks

Notice: All referenced brands, product names, service names and trademarks are the property of their respective owners.

5. Contents

1	Introduction	3
1.1	Introduction to low V_{CEsat} transistors	3
2	Load switch circuit	4
2.1	Important parameter for BJTs in a load switch application	4
2.1.1	Comparison between different low V_{CEsat} transistors in a load switch application	5
3	Summary	10
4	Legal information	11
4.1	Definitions	11
4.2	Disclaimers	11
4.3	Trademarks	11
5	Contents	12

Please be aware that important notices concerning this document and the product(s) described herein, have been included in section 'Legal information'.

© NXP B.V. 2013.

All rights reserved.

For more information, please visit: <http://www.nxp.com>

For sales office addresses, please send an email to: salesaddresses@nxp.com

Date of release: 13 March 2013

Document identifier: AN10909