

Important notice

Dear Customer,

On 7 February 2017 the former NXP Standard Product business became a new company with the tradename **Nexperia**. Nexperia is an industry leading supplier of Discrete, Logic and PowerMOS semiconductors with its focus on the automotive, industrial, computing, consumer and wearable application markets

In data sheets and application notes which still contain NXP or Philips Semiconductors references, use the references to Nexperia, as shown below.

Instead of <http://www.nxp.com>, <http://www.philips.com/> or <http://www.semiconductors.philips.com/>, use <http://www.nexperia.com>

Instead of sales.addresses@www.nxp.com or sales.addresses@www.semiconductors.philips.com, use salesaddresses@nexperia.com (email)

Replace the copyright notice at the bottom of each page or elsewhere in the document, depending on the version, as shown below:

- © NXP N.V. (year). All rights reserved or © Koninklijke Philips Electronics N.V. (year). All rights reserved

Should be replaced with:

- © **Nexperia B.V. (year). All rights reserved.**

If you have any questions related to the data sheet, please contact our nearest sales office via e-mail or telephone (details via salesaddresses@nexperia.com). Thank you for your cooperation and understanding,

Kind regards,

Team Nexperia

AN11641

Relay replacement by NXP high-power bipolar transistors in LFPAK56

Rev. 1 — 21 May 2015

Application note

Document information

| Info | Content |
|-----------------|--|
| Keywords | High-power bipolar transistors, PHPT series, LFPAK56, relay |
| Abstract | This application note describes NXP Semiconductors low V_{CEsat} bipolar PHPT portfolio. It gives a guideline which parameters must be taken into account to drive a brushed DC motor. |



Revision history

| Rev | Date | Description |
|-----|----------|-----------------|
| 1 | 20150521 | Initial version |

Contact information

For more information, please visit: <http://www.nxp.com>

For sales office addresses, please send an email to: salesaddresses@nxp.com

1. Introduction

NXP's bipolar power transistors in LFPAK use the latest BISS (Breakthrough In Small Signal) transistor technology. They include mesh-emitter-design technology IP-platform to achieve high-power devices with low V_{CEsat} (saturation collector-emitter voltage) voltage drop and high current gain. By this upmarket development, NXP wants to extend its powerful and successful BISS transistor portfolio into the medium power and power range in order to reach full traction for its high-power low V_{CEsat} and high-current mesh-emitter technology. To achieve this aim NXP uses a package supporting the high power dissipation demand of its transistor portfolio. LFPAK offers superior low thermal impedance Z_{th} and therefore high thermal power capability up to 5 W.

Key parameters are current distribution (which should be as homogenous as possible) over chip volume, and little spreading resistance in the metallization on the front of the chip. In the case of BISS transistors, a homogeneous current distribution in the chip is achieved by the latest mesh-emitter-design technology IP-platform, which breaks the transistor down into corresponding cell structures. Soft-solder capable front and back metallization combine this wafer technology with the LFPAK-package platform requirements introducing new-developed metal stack interfaces for chip front and back interface. They are optimized for low-resistivity contact of all transistor terminals to the package outline.

The high-performance/high-reliability package platform LFPAK provides clip-bond for emitter and base contact. This achieves low electrical and thermal resistivity of the devices on all terminals. The electrical package resistivity is below 1 m Ω . The overall thermal impedance of the power transistors in the current chip-size range is below 6 K/W. Soft-solder die and clip attach establish a rugged package architecture with up to $T_{j(max)} = 175$ °C high-temperature capability.

1.1 Features and benefits

- High power dissipation (P_{tot})
- Suitable for high-temperature applications (175 °C)
- Space-saving 5 × 6 mm: package outline is half the size of equivalent transistors in DPAK, SOT223, and other packages
- Low profile (1 mm)
- High reliability and mechanical ruggedness thanks to solid copper clip (no wires)
- High energy efficiency due to less heat generation
- AEC-Q101 qualified
- Future-proof, growing portfolio

2. Brushed DC motor control

Modern DC motors are used in various applications:

- Power windows
- Wipers
- Blower motors (heating / cooling)
- Trunk lifter
- Steering wheel adjustment
- Seat adjustment

A lot of these applications are using relays for driving the brushed DC motor. This application note shows which parameter must be taken into account to replace relays by bipolar transistors in H-bridge configuration controlled by a Pulse Width Modulation (PWM) signal.

The used DC brushed motor for this application note has following characteristics:

- Nominal operating voltage: 12 V
- Nominal operating current: 3 A
- Blocked operating current: 8 A

2.1 Relay operation

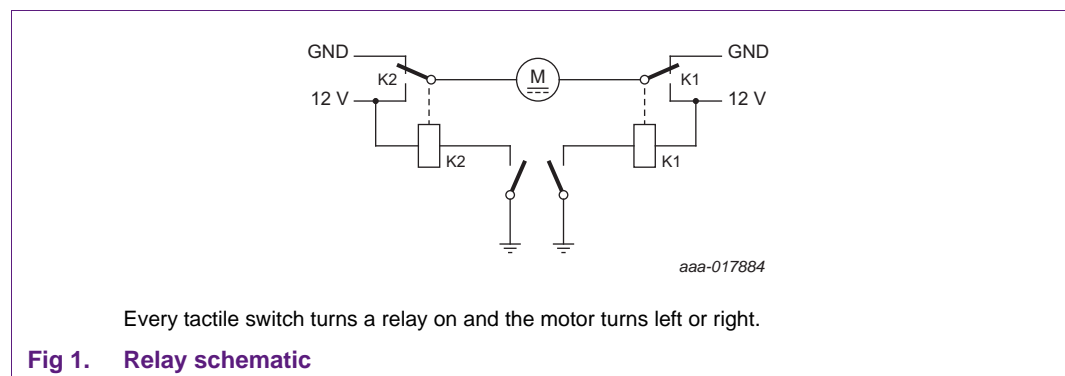

2.2 Bipolar Junction Transistor (BJT) operation

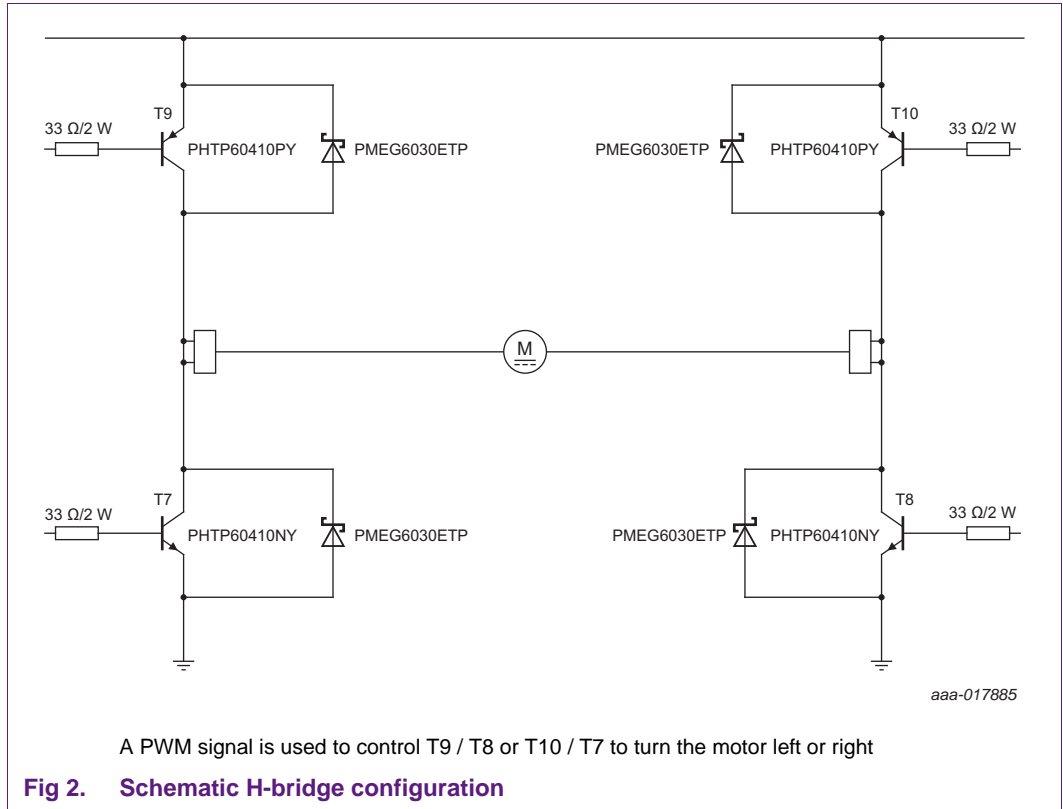

3. Parameters of NXP high-power bipolar transistors (PHPT series)

Due to the maximum motor current of 8 A, the voltage across collector and emitter must be aligned with the power dissipation of the LFPAK56 package.

Figure 3 shows a typical value for V_{CEsat} of PHPT60410NY.

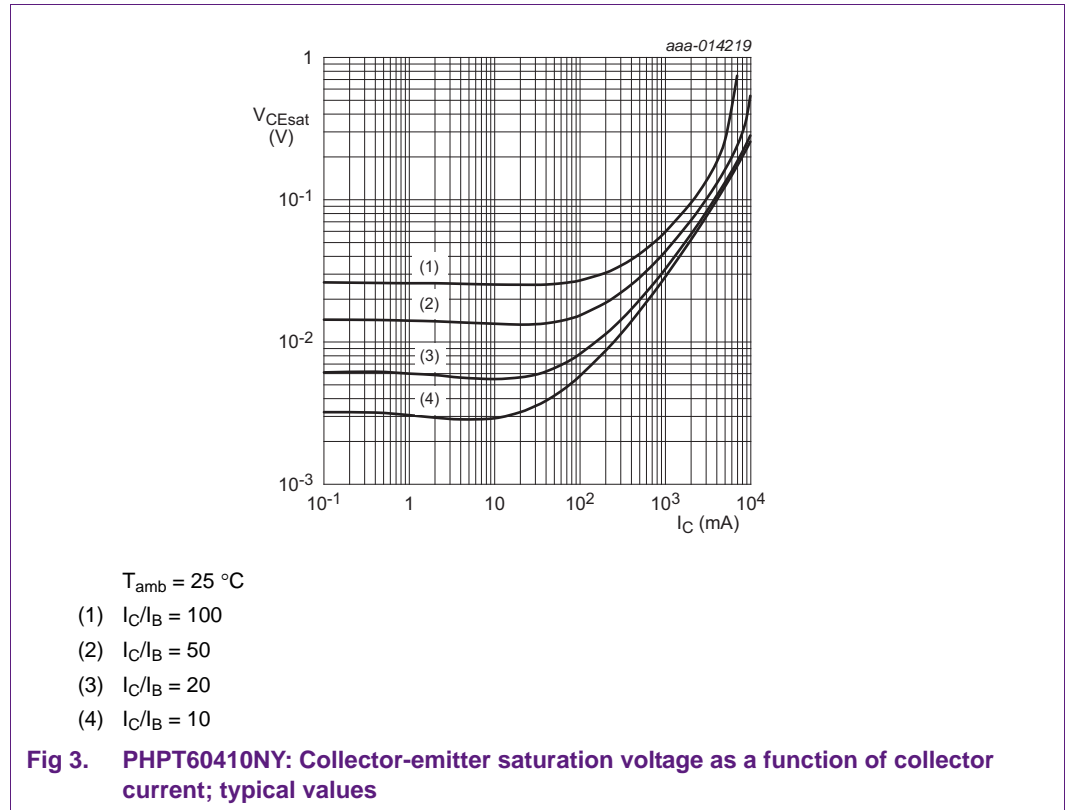

At $h_{FE} = 50$ (base current $I_B = 160\text{ mA}$) and at maximum motor current (I_{Cmax}), a 300 mV voltage drop across collector and emitter must be expected. The outcome of this is $P_{tot} = 2.4\text{ W}$ in continuous mode.

For this application note, following PWM parameters have been chosen:

- PWM frequency = 125 Hz / $t_p = 8\text{ ms}$
- Duty cycle = 0.5

Figure 4 shows the thermal impedance of a PHPT60410NY under these conditions.

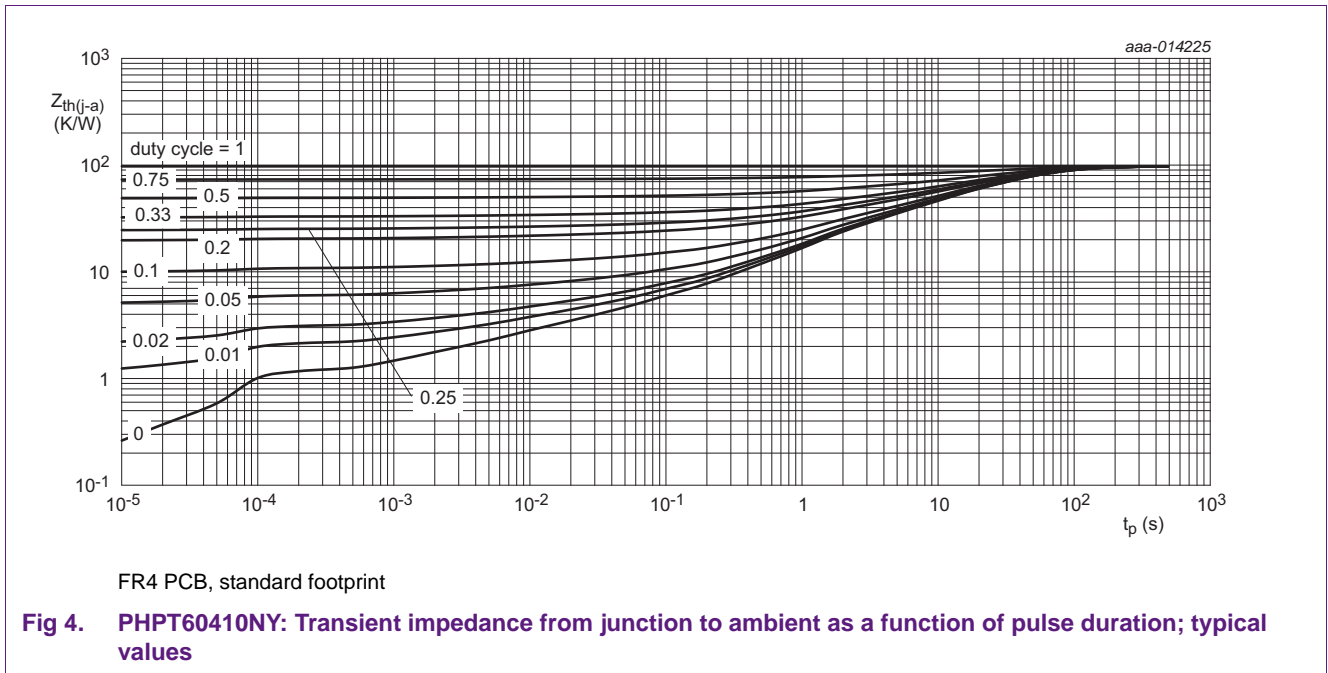

Given that:

$$P_{tot} = \frac{T_{j(max)} - T_{amb}}{R_{th(j-a)}} \tag{1}$$

then, at $T_{j(max)} = 175\text{ °C}$, if $Z_{th(j-a)} = 50\text{ K/W}$, then $P_{tot} = 3\text{ W}$ at $T_{amb} = 25\text{ °C}$ or $P_{tot} = 2.4\text{ W}$ at $T_{amb} = 55\text{ °C}$ on standard footprint.

4. Demoboard

In order to verify all theoretical approaches, NXP designed a test board with a PWM-driven H-bridge and for comparison tow relays to drive a brushed DC motor. Each tactile switch turns the motor left or right. The relay part is isolated from the PWM stage.

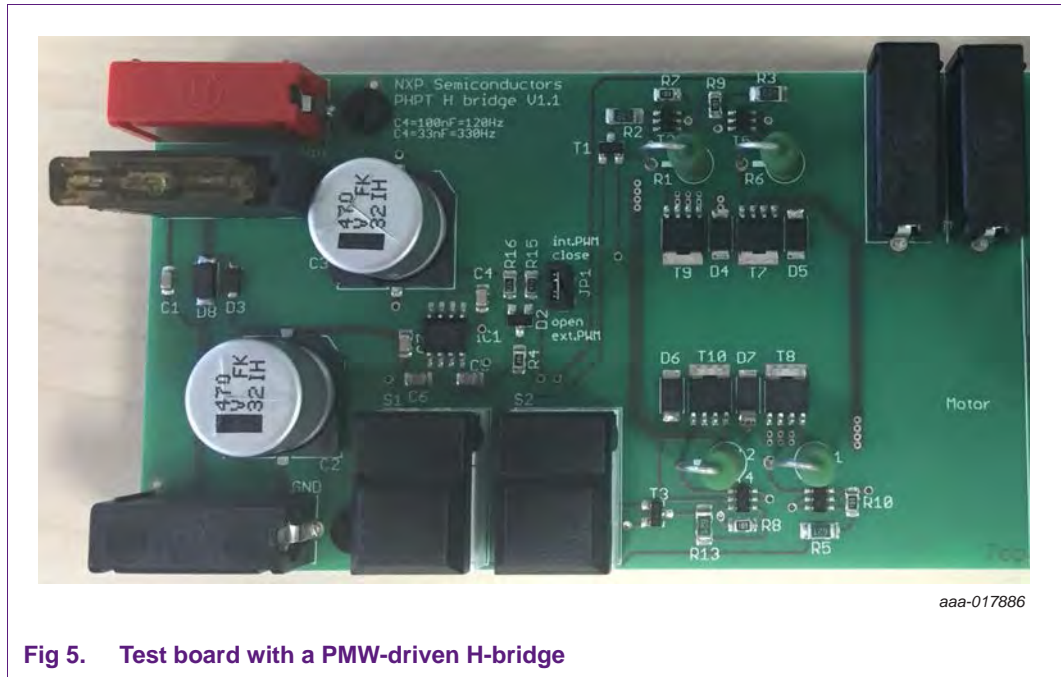

Fig 5. Test board with a PMW-driven H-bridge

4.1 Electrical verification

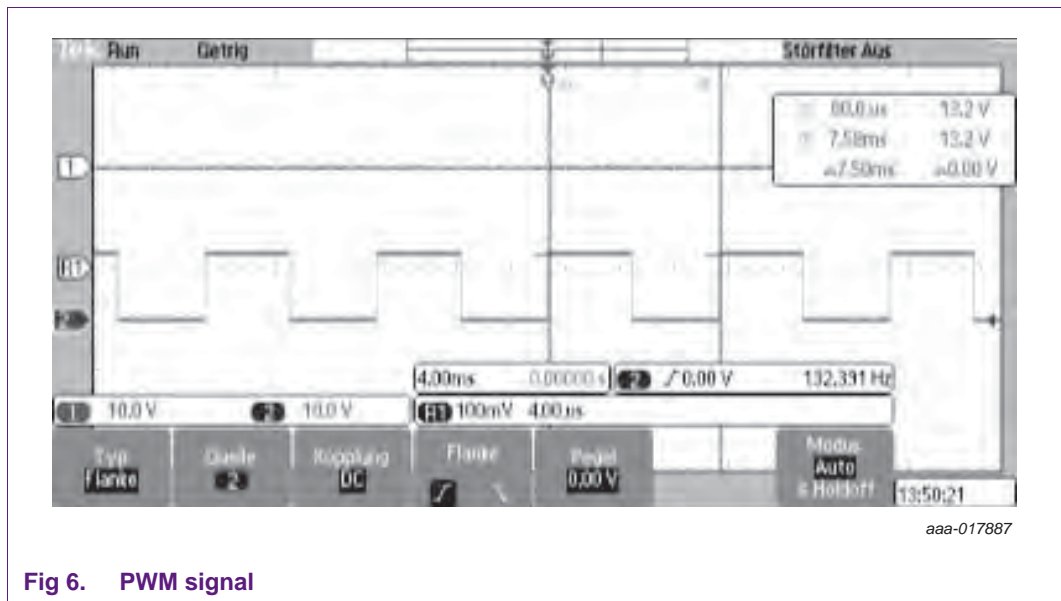

Fig 6. PWM signal

PWM control signal is running with a frequency of 130 Hz and a duty cycle δ of 0.5.

The PWM is generated by a simple NE555 circuit. At a jumper, the signal can be disconnected from the tactile switches. That is why the frequency decreases to 125 Hz during motor operation.

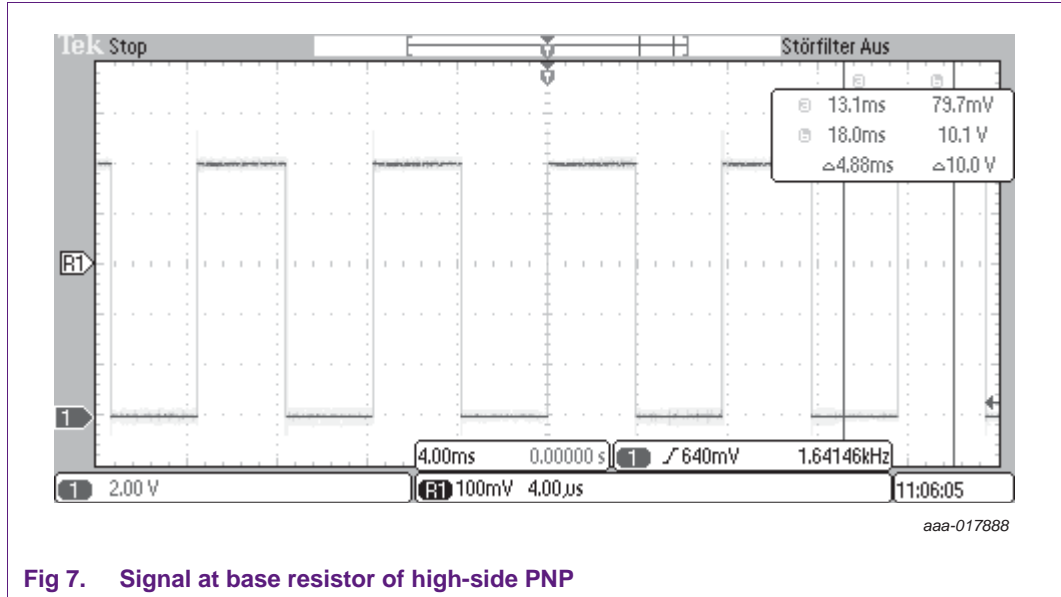

Fig 7. Signal at base resistor of high-side PNP

In peak, the base current I_B can be calculated with voltage $V = 10\text{ V}$ and resistance $R = 33\ \Omega$. The outcome of this is $I_B = 300\text{ mA}$ or $I_B = 150\text{ mA}$ in average.

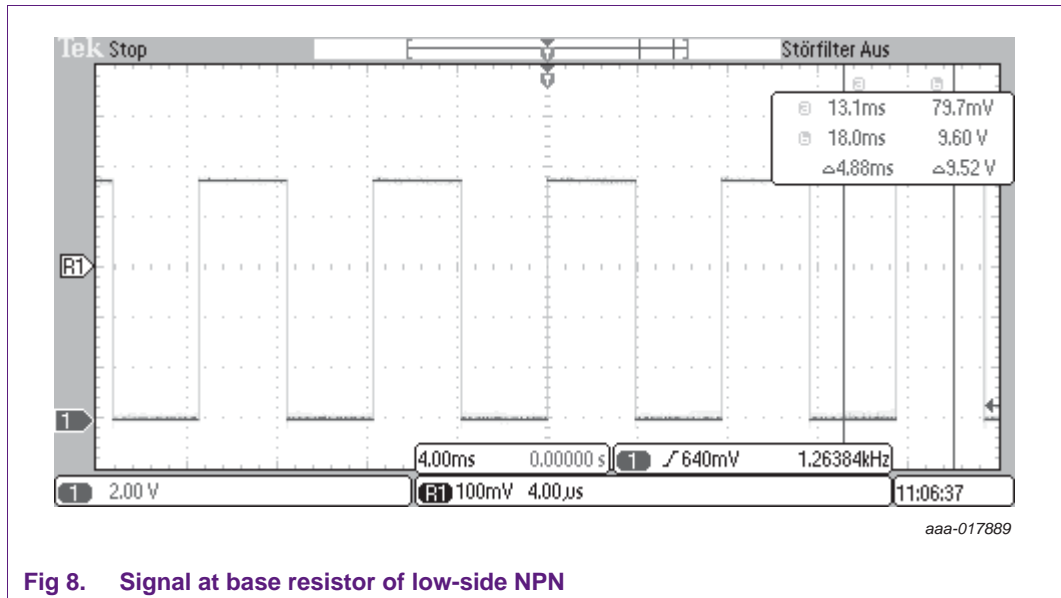

Fig 8. Signal at base resistor of low-side NPN

In peak, the current is 288 mA, in average 144 mA.

In real application, the transistors are running at a slightly higher h_{FE} . The base resistor and workpoint were calculated with respect to high blocking current of 8 A. In normal application, the motor current is measured by a microcontroller in order to stop the turning of the motor on security reason. The following scope trace (Figure 9) was measured across a resistor of 235 mΩ and shows following motor current:

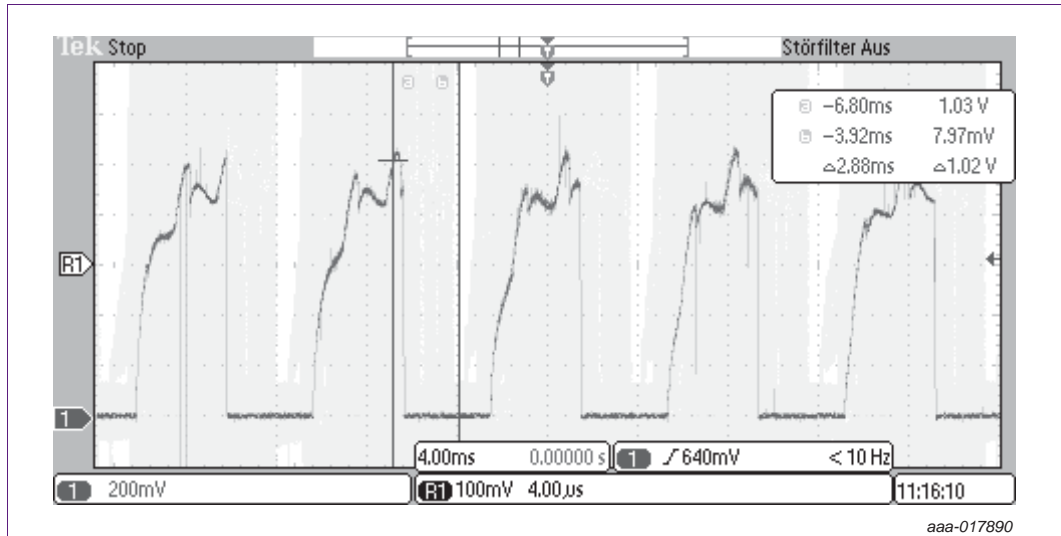

Fig 9. Motor current

In peaks, the motor current is 4.25 A. In average, the motor is running with 2.125 A. From this, $h_{FE} = 15$ in normal operation mode.

4.2 Thermal results

All measurements were performed with a motor in normal operation mode.

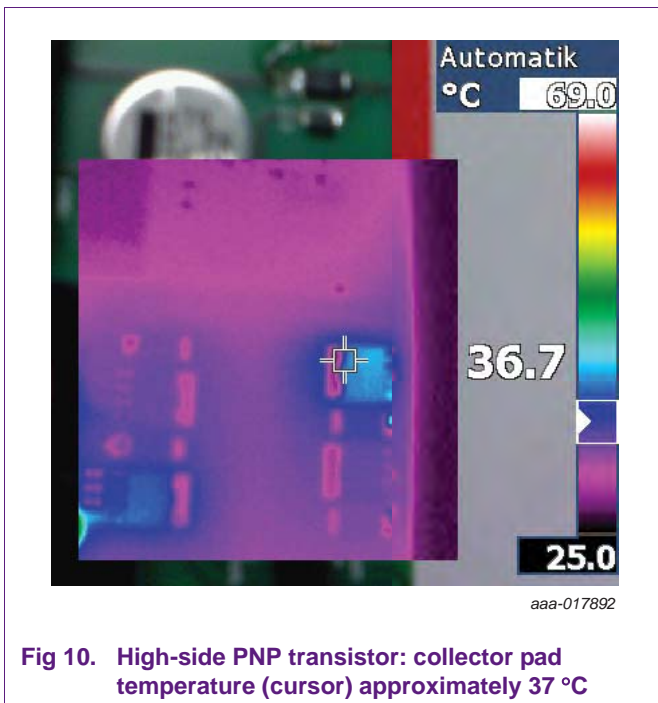

Fig 10. High-side PNP transistor: collector pad temperature (cursor) approximately 37 °C

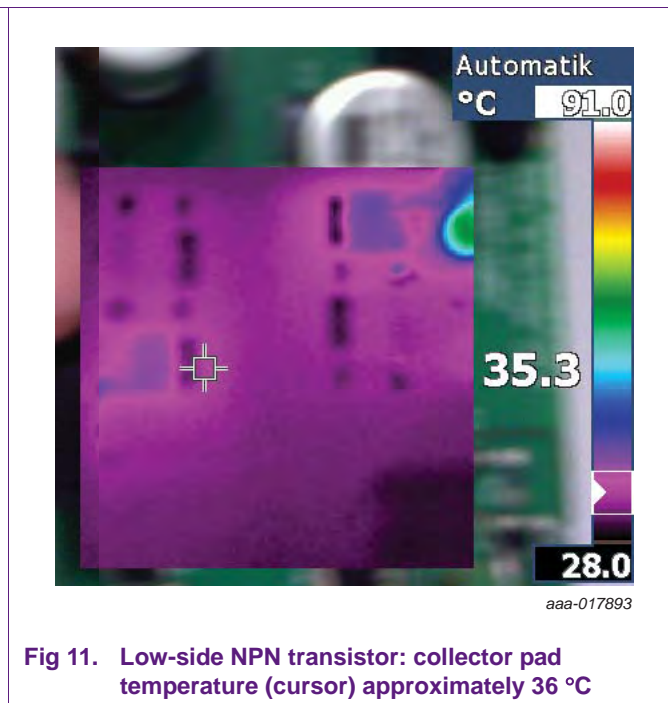

Fig 11. Low-side NPN transistor: collector pad temperature (cursor) approximately 36 °C

4.3 EMI results

Used equipment to measure the ElectroMagnetic Interference (EMI) performance of the H-bridge with PHPT-series ($V_{CE} = 40\text{ V}$, $I_C = 10\text{ A}$) versus a standard automotive relay (12 V; 50 mA coil current, 15 A max):

- Power supply: WIMO GSV3000
- Artificial network: Schwarzbeck NNBM 8125
- LFPAK demoboard
- DC Motor: Bosch AHC 12V
- EMI test receiver: Rohde & Schwarz ESCI3

4.3.1 Board-powered no-switch

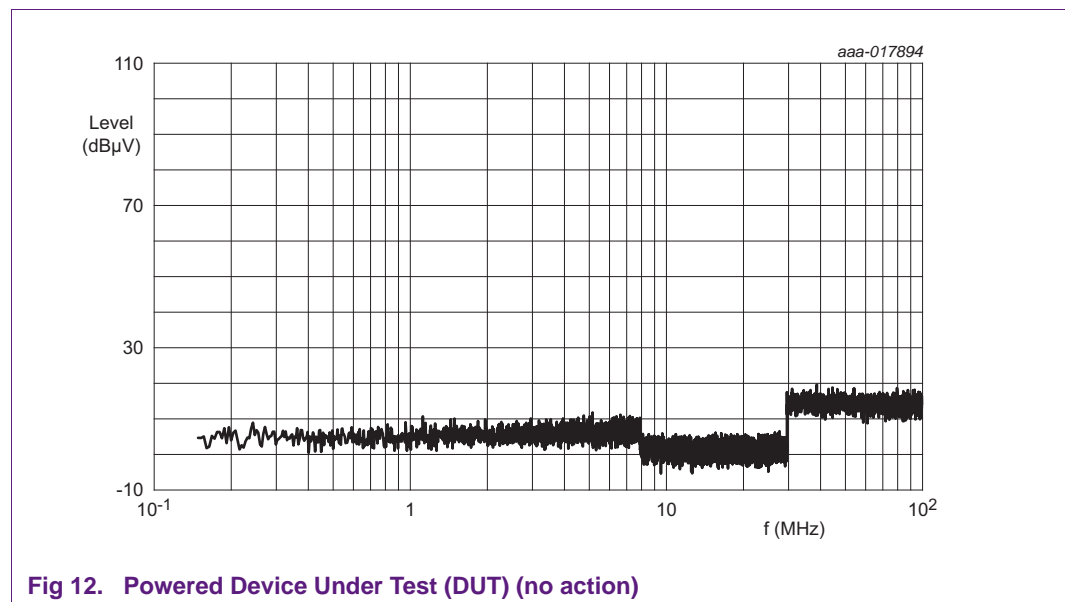

4.3.2 Relay operated

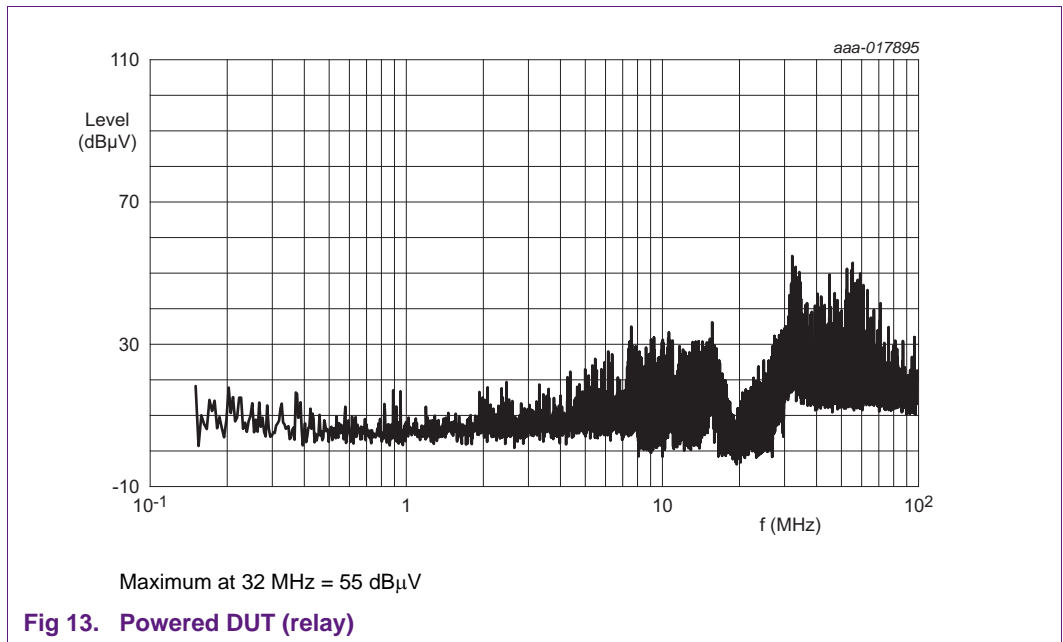

4.3.3 H-bridge operated

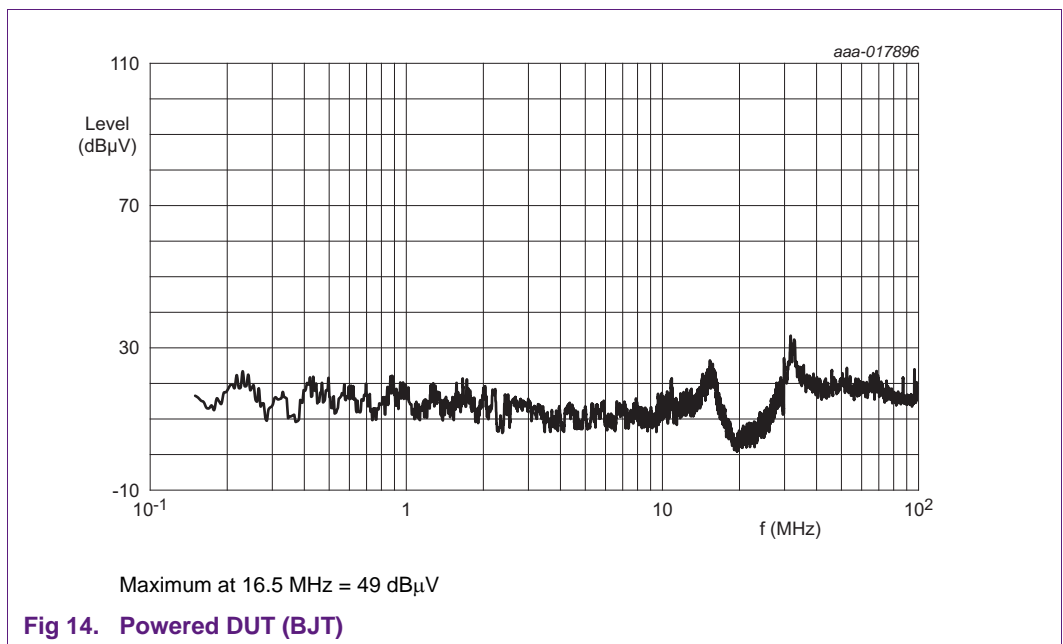

4.3.4 H-bridge operated in PWM Mode

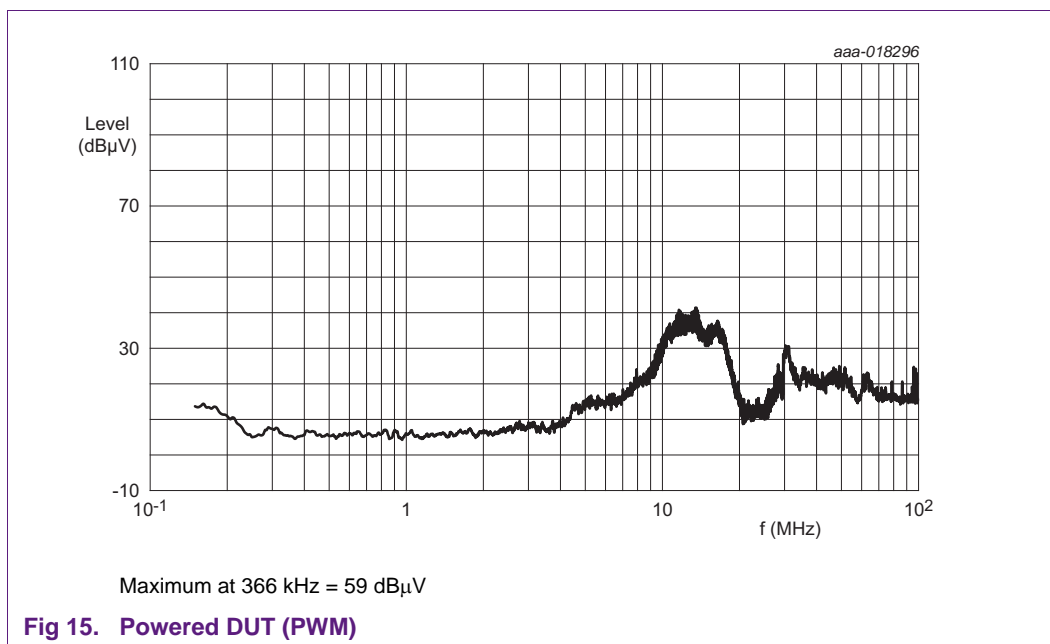

5. Results

If all necessary parameters are taken into account, relays can be replaced by bipolar transistors, like NXP's PHPT-series in LFPAK.

The advantages of a silicon-based solution compare to relay are:

- Reliable performance over lifetime (AEC-Q101)
- Significantly better EMI performance
- No contact bouncing
- Less board space

6. Product portfolio in LFPAK

Table 1. NXP's product portfolio in LFPAK

| Type number | Configuration | V _{CEO} | I _c | AEC-Q101 |
|--------------|---------------|------------------|----------------|----------|
| PHPT60406NY | NPN | 40 V | 6 A | YES |
| PHPT60406PY | PNP | 40 V | 6 A | YES |
| PHPT60410NY | NPN | 40 V | 10 A | YES |
| PHPT60410PY | PNP | 40 V | 10 A | YES |
| PHPT60603NY | NPN | 60 V | 3 A | YES |
| PHPT60603PY | PNP | 60 V | 3 A | YES |
| PHPT60606NY | NPN | 60 V | 6 A | YES |
| PHPT60606PY | PNP | 60 V | 6 A | YES |
| PHPT60610NY | NPN | 60 V | 10 A | YES |
| PHPT60610PY | PNP | 60 V | 10 A | YES |
| PHPT61002NYC | NPN | 100 V | 2 A | NO |
| PHPT61002PYC | PNP | 100 V | 2 A | NO |
| PHPT61003NY | NPN | 100 V | 3 A | YES |
| PHPT61003PY | PNP | 100 V | 3 A | YES |
| PHPT61006NY | NPN | 100 V | 6 A | YES |
| PHPT61006PY | PNP | 100 V | 6 A | YES |
| PHPT61010NY | NPN | 100 V | 10 A | YES |
| PHPT61010PY | PNP | 100 V | 10 A | YES |

7. Sources

- NXP Semiconductors - PHPT60410PY Product data sheet Rev. 1 - 21 January 2015
- NXP Semiconductors - PHPT60410NY Product data sheet Rev. 1 - 21 January 2015

8. Legal information

8.1 Definitions

Draft — The document is a draft version only. The content is still under internal review and subject to formal approval, which may result in modifications or additions. NXP Semiconductors does not give any representations or warranties as to the accuracy or completeness of information included herein and shall have no liability for the consequences of use of such information.

8.2 Disclaimers

Limited warranty and liability — Information in this document is believed to be accurate and reliable. However, NXP Semiconductors does not give any representations or warranties, expressed or implied, as to the accuracy or completeness of such information and shall have no liability for the consequences of use of such information. NXP Semiconductors takes no responsibility for the content in this document if provided by an information source outside of NXP Semiconductors.

In no event shall NXP Semiconductors be liable for any indirect, incidental, punitive, special or consequential damages (including - without limitation - lost profits, lost savings, business interruption, costs related to the removal or replacement of any products or rework charges) whether or not such damages are based on tort (including negligence), warranty, breach of contract or any other legal theory.

Notwithstanding any damages that customer might incur for any reason whatsoever, NXP Semiconductors' aggregate and cumulative liability towards customer for the products described herein shall be limited in accordance with the *Terms and conditions of commercial sale* of NXP Semiconductors.

Right to make changes — NXP Semiconductors reserves the right to make changes to information published in this document, including without limitation specifications and product descriptions, at any time and without notice. This document supersedes and replaces all information supplied prior to the publication hereof.

Suitability for use — NXP Semiconductors products are not designed, authorized or warranted to be suitable for use in life support, life-critical or safety-critical systems or equipment, nor in applications where failure or malfunction of an NXP Semiconductors product can reasonably be expected to result in personal injury, death or severe property or environmental damage. NXP Semiconductors and its suppliers accept no liability for inclusion and/or use of NXP Semiconductors products in such equipment or applications and therefore such inclusion and/or use is at the customer's own risk.

Applications — Applications that are described herein for any of these products are for illustrative purposes only. NXP Semiconductors makes no representation or warranty that such applications will be suitable for the specified use without further testing or modification.

Customers are responsible for the design and operation of their applications and products using NXP Semiconductors products, and NXP Semiconductors accepts no liability for any assistance with applications or customer product

design. It is customer's sole responsibility to determine whether the NXP Semiconductors product is suitable and fit for the customer's applications and products planned, as well as for the planned application and use of customer's third party customer(s). Customers should provide appropriate design and operating safeguards to minimize the risks associated with their applications and products.

NXP Semiconductors does not accept any liability related to any default, damage, costs or problem which is based on any weakness or default in the customer's applications or products, or the application or use by customer's third party customer(s). Customer is responsible for doing all necessary testing for the customer's applications and products using NXP Semiconductors products in order to avoid a default of the applications and the products or of the application or use by customer's third party customer(s). NXP does not accept any liability in this respect.

Export control — This document as well as the item(s) described herein may be subject to export control regulations. Export might require a prior authorization from competent authorities.

Evaluation products — This product is provided on an "as is" and "with all faults" basis for evaluation purposes only. NXP Semiconductors, its affiliates and their suppliers expressly disclaim all warranties, whether express, implied or statutory, including but not limited to the implied warranties of non-infringement, merchantability and fitness for a particular purpose. The entire risk as to the quality, or arising out of the use or performance, of this product remains with customer.

In no event shall NXP Semiconductors, its affiliates or their suppliers be liable to customer for any special, indirect, consequential, punitive or incidental damages (including without limitation damages for loss of business, business interruption, loss of use, loss of data or information, and the like) arising out of the use of or inability to use the product, whether or not based on tort (including negligence), strict liability, breach of contract, breach of warranty or any other theory, even if advised of the possibility of such damages.

Notwithstanding any damages that customer might incur for any reason whatsoever (including without limitation, all damages referenced above and all direct or general damages), the entire liability of NXP Semiconductors, its affiliates and their suppliers and customer's exclusive remedy for all of the foregoing shall be limited to actual damages incurred by customer based on reasonable reliance up to the greater of the amount actually paid by customer for the product or five dollars (US\$5.00). The foregoing limitations, exclusions and disclaimers shall apply to the maximum extent permitted by applicable law, even if any remedy fails of its essential purpose.

Translations — A non-English (translated) version of a document is for reference only. The English version shall prevail in case of any discrepancy between the translated and English versions.

8.3 Trademarks

Notice: All referenced brands, product names, service names and trademarks are the property of their respective owners.

9. Contents

| | | |
|----------|---|-----------|
| 1 | Introduction | 3 |
| 1.1 | Features and benefits | 3 |
| 2 | Brushed DC motor control | 4 |
| 2.1 | Relay operation | 4 |
| 2.2 | Bipolar Junction Transistor (BJT) operation ... | 5 |
| 3 | Parameters of NXP high-power bipolar transistors (PHPT series) | 6 |
| 4 | Demoboard | 8 |
| 4.1 | Electrical verification | 8 |
| 4.2 | Thermal results | 10 |
| 4.3 | EMI results | 11 |
| 4.3.1 | Board-powered no-switch | 11 |
| 4.3.2 | Relay operated | 12 |
| 4.3.3 | H-bridge operated | 12 |
| 4.3.4 | H-bridge operated in PWM Mode | 13 |
| 5 | Results | 13 |
| 6 | Product portfolio in LFPAK | 14 |
| 7 | Sources | 14 |
| 8 | Legal information | 15 |
| 8.1 | Definitions | 15 |
| 8.2 | Disclaimers | 15 |
| 8.3 | Trademarks | 15 |
| 9 | Contents | 16 |

Please be aware that important notices concerning this document and the product(s) described herein, have been included in section 'Legal information'.

© NXP Semiconductors N.V. 2015.

All rights reserved.

For more information, please visit: <http://www.nxp.com>

For sales office addresses, please send an email to: salesaddresses@nxp.com

Date of release: 21 May 2015

Document identifier: AN11641