



AN90003

LFPAK MOSFET thermal design guide

Rev. 3.1 — 22 January 2021

application note

Document information

Information	Content
Keywords	Thermal design, LFPAK56D, LFPAK33, LFPAK56, LFPAK88
Abstract	Thermal design guide: estimate of MOSFET power dissipation capability depending on PCB design.

1. Introduction

This application note is a guide to assist design engineers in understanding the power dissipation limits of the LPAK family of packages. The maximum power that a MOSFET can dissipate is considered as a function of the Printed Circuit Board (PCB) design, using some common configurations. The application notes comprises of three main sections. The first section gives some background on MOSFET power loss and the thermal environment. The next two sections address separately the low power LPAKs (LPAK56D and LPAK33) and the high power LPAKs (LPAK56 and LPAK88).

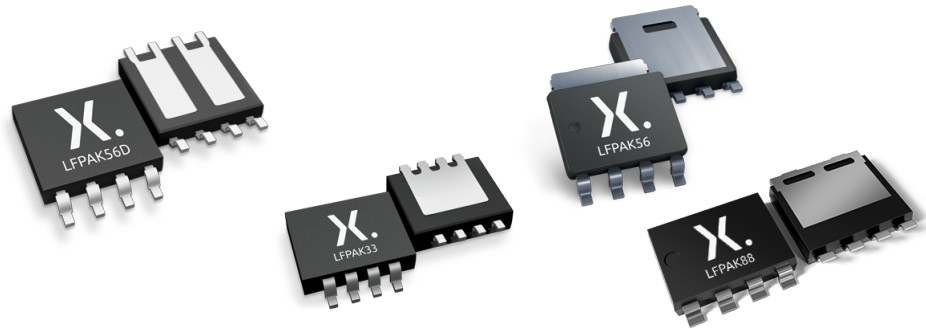

2. MOSFET power dissipation and the design environment

During normal operation, MOSFETs can exhibit three kinds of power losses:

- Switching losses – due to voltage and current being non-zero during the transition between the ON and OFF states.
- Conduction losses – when the device is fully on due to its on-state resistance $R_{DS(on)}$.
- Avalanche losses – if the device breakdown voltage is exceeded and an avalanche event occurs.

The shape of the power can change depending on the nature of the load. A generalized model of the total power dissipated by a MOSFET is the sum of these three losses, see [Equation \(1\)](#).

$$P_{tot} = P_{sw} + P_{cond} + P_{av} \quad (1)$$

In addition to electrical requirements another challenge is often the harsh environment that a device needs to operate in, particularly in terms of temperature. For instance, in automotive and industrial applications it's not uncommon to encounter high ambient temperature requirements, (from 85 °C up to 125 °C), this limits the amount of power that a MOSFET can safely handle.

Semiconductor devices are not the only parts to consider when dealing with high temperatures. For instance, the PCB material FR4 has a maximum operating temperature of around 130 °C, depending on manufacturer and chemistry, this is much lower than the limit specified for the junction of a silicon die (175 °C).

Modern applications continue to push the limits of power MOSFETs, while searching for better and better performances. As a consequence thermals have become one of the most important aspects of systems design. One way to address thermal issues is to carefully choose a device with the appropriate performances and provide a good enough path through which heat can flow freely, avoiding any impact on the device reliability.

2.1. Heat propagation phenomena

Heat propagates because of a temperature difference between the junction and the outside/ambient. Propagation occurs from junction and the outside/ambient through different material, from solids (silicon, copper, FR4, aluminum) to fluids (surrounding air or even air pockets trapped in the solder joints on the PCB). Heat finds a path whether it's defined by an engineer or not. This means that if the path is not designed correctly then heat might get trapped and raise the temperature of one or multiple mediums.

The physical phenomena by which heat can propagate are: conduction, convection and radiation.

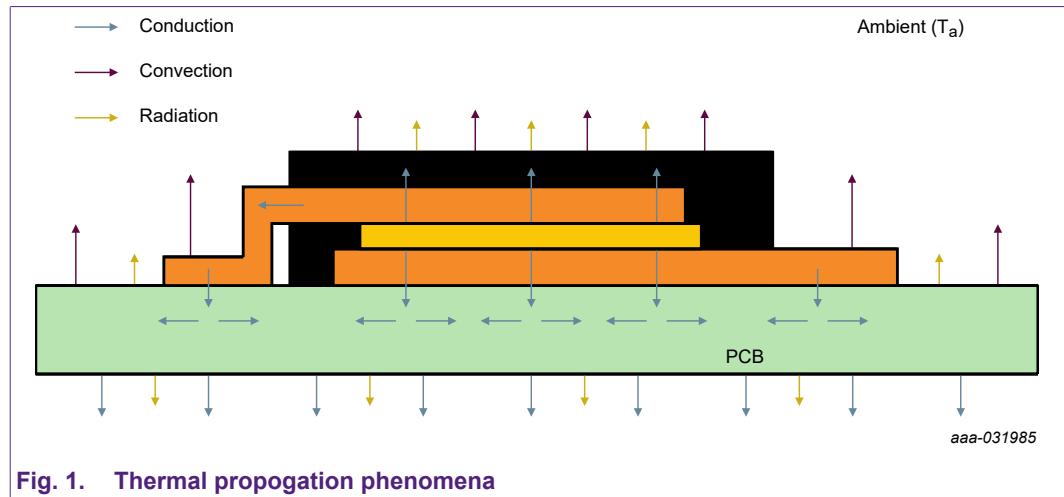

Fig. 1. Thermal propagation phenomena

2.1.1. Conduction

Conduction is the propagation of heat in a solid medium due to a temperature difference within it, and it is caused by the random movement of atoms and molecules. The rate of heat flow Q is directly proportional to the cross-section area A , temperature difference and thermal conductivity k . It is inversely proportional to the length x of the heat path, see Equation (2).

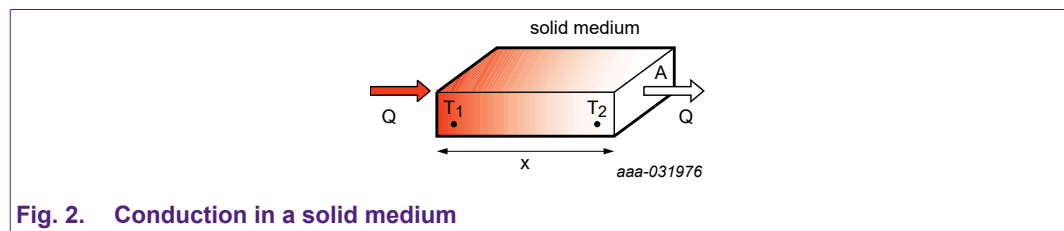

Fig. 2. Conduction in a solid medium

$$Q = k \cdot A \cdot \frac{T_1 - T_2}{x} \tag{2}$$

Thermal conductivity, measured as $W/(mK)$, is a physical property of a material and defines its ability to conduct heat. The higher its value the higher the rate of heat transfer, therefore the better thermal conductor. From Equation 2 it can be derived that rate of heat flow is measured in W . Therefore, heat is measured in Joule (Ws).

Table 1 lists some materials with their thermal conductivity values. Air is a very bad conductor of heat, thus a good thermal insulator. It's thermal conductivity is 2,000 times lower than that of steel. Notice how thermal glue has a very low thermal conductivity of less than 2, (generic brand). Thermal glue is not a good thermal conductor, however its main function is to create a good fit between two surfaces that otherwise would form trapped pockets of air, which is 100 times a better insulator than the glue itself.

Table 1. Typical thermal conductivity values

Material	k (W/mK)
Air (not moving)	0.024
Brick	0.6
Glass	0.8
Thermal glue	1.78
Steel	50.2
Brass	109
Silicon	130
Aluminium	205
Copper	385
Silver	406
Diamond	1000

2.1.2. Convection

Convection is the transfer of heat from a solid body to a fluid due to its movement with respect to the surface of the body, and it is promoted by a difference in temperature between the two mediums. The fluid may be a gas (air) or a liquid.

Here the rate of heat flow depends only on surface A, temperature difference and convection coefficient *h*, see [Equation \(3\)](#).

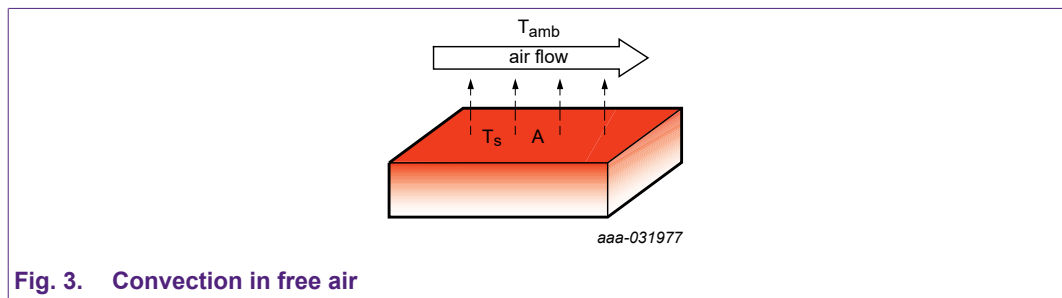

Fig. 3. Convection in free air

$$Q = h \cdot A \cdot (T_s - T_{amb}) \tag{3}$$

The convection coefficient is not a physical property of the fluid (like the conduction coefficient) but an abstract quantity verified by experimentation. It depends on fluid density, velocity, viscosity, turbulence and on the solid medium surface geometry.

The convection coefficient is measured in W/(m²K). [Table 2](#) lists some values measured in different scenarios of free/natural and forced cooling.

Table 2. Thermal convection coefficient values

Flow type	h (W/m ² K)	
	Free air	Forced cooling
Gases	2 - 20	25 - 300
Air	10	100
Liquids	50 - 1,000	100 - 40,000
Phase change	2,500 - 100,000	

As can be seen during a phase change the convection coefficient rises dramatically up to 100,000. This is due to the fact that during a phase change all the energy involved, and transferred to the fluid, is used to rearrange molecules structure and does not result in a temperature change.

2.1.3. Radiation

Radiation is the propagation of heat via infrared radiation.

The main benefit of radiation is that as the ambient temperature increases, and the component temperature with it, the heat transfer by radiation increases as well. As you can see in [Equation \(4\)](#), it depends on the fourth power of temperature. The radiation is bigger but not by a lot and the overall effect is that radiation does not help a body get cooler.

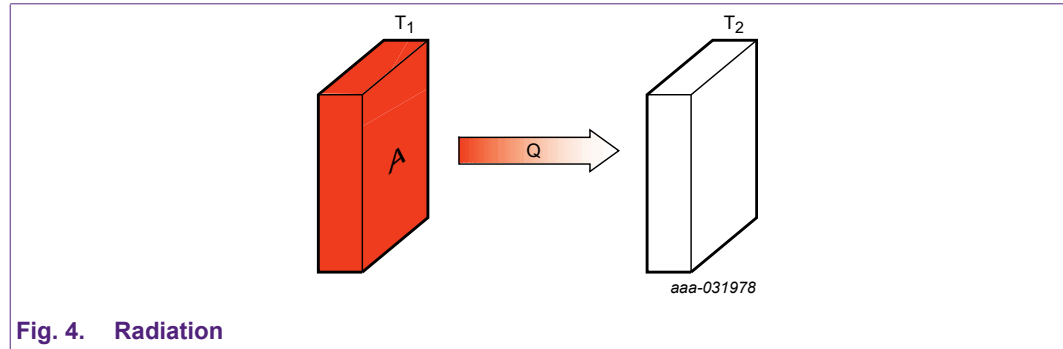

Fig. 4. Radiation

$$Q = \epsilon \cdot \sigma \cdot A \cdot (T_1^4 - T_2^4) \tag{4}$$

The amount of radiation is determined by the surface emissivity. Emissivity of a material is measured between 0 and 1. A perfect emitter is called a black body because it emits 100% of the energy it absorbs, and is assigned an emissivity value of 1. [Table 3](#) below gives emissivity values for different materials.

Table 3. Typical emissivity values

Material	Emissivity coefficient (ε)
Aluminium, polished	0.05
Aluminium, oxidized	0.25
Black electrical tape	0.95
Copper, polished	0.01
Copper, oxidized	0.65
Steel, oxidized	0.88
Water	0.98

A new piece of polished aluminum has emissivity of 0.05, (not good), its emissivity increases as it oxides by 5 times. Every object emits thermal radiation, the amount of radiation that a particular object emits as a function of wavelength looks as a bell shaped curve. Energy is emitted at all frequencies but the major part of the emission occurs at a certain wavelength range which depends on the source temperature. The higher the temperature the higher the frequency (lower the wavelength), that is why we see materials change color as they heat up.

At the receiving side, for most of the surfaces, the same graph looks quite flat but to a very small range of wavelengths at which the object absorbs all the impinging radiation. These surfaces are called selective surfaces, because they absorb only certain wavelengths.

2.2. Thermal – Electrical analogy

When considering thermal propagation, classical methods of analysis may be used. These are based on the thermal equations and thermal networks. These describe the paths through which heat propagates through mediums or from one medium to another.

Any thermal network can be modelled by means of an electrical circuit. An analogy for every thermal parameter can be found in the electrical domain. The respective analogues of electric potential and current are temperature difference and rate of heat flow. Based on these it may be observed that the thermal resistance is the ratio of temperature and rate of heat flow similarly to how the voltage and current ratio defines the electrical resistance using Ohm's law. The main analogies may be seen in [Table 4](#) below. Based on these, thermal networks can be solved using many of the electrical theory laws such as Ohm's and Kirchhoff's laws. Also circuits can be simplified by means of series and parallel resistor equivalences.

Table 4. Thermal and electrical analogous parameters

Thermal	Electrical
Temperature T (°C)	Voltage V (V)
Rate of heat flow Q (W)	Current I (A)
Thermal resistance R_{th} (K/W)	Resistance R (Ω)
Thermal capacitance C_{th} [W·s/K]	Capacitance C (A·s/V = F)

An example of a thermal circuit modelled in the electrical domain using a SPICE software may be seen in [Fig. 5](#). [Fig. 6](#) shows the response of this example circuit as a temperature plot, where the transient and steady state thermal behaviour may be seen.

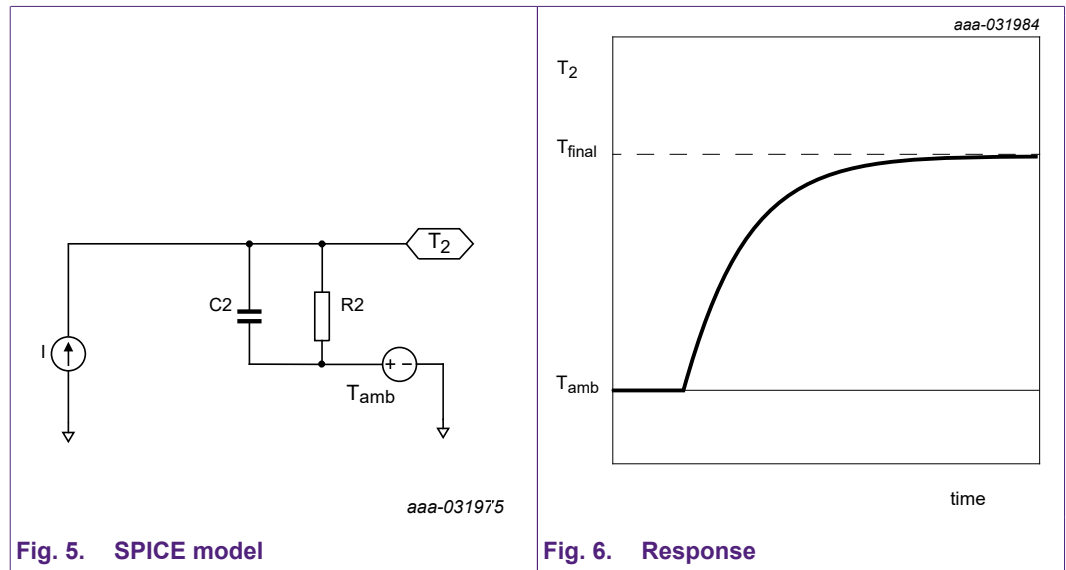

Fig. 5. SPICE model

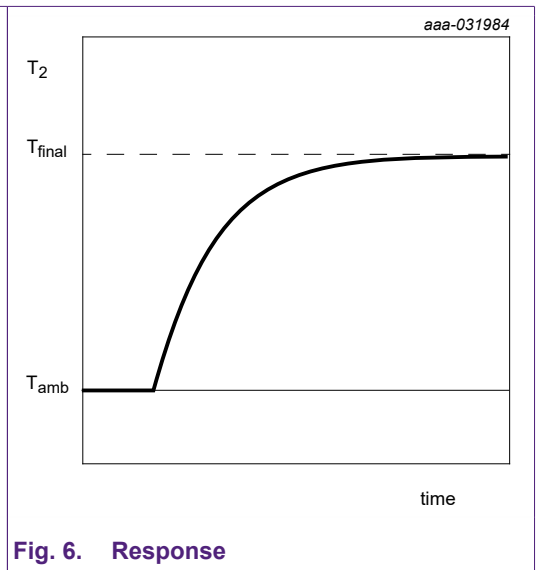

Fig. 6. Response

2.2.1. Thermal resistance

Thermal resistance is a measure of the inertia of a material or medium towards heat flow, just like the electrical resistance is to the movement of electrons. It is therefore a physical property of the specific component. It is calculated as the ratio of the temperature difference between two points and the rate of heat flow, therefore as K/W. The thermal and electrical models may be seen in the pictures below.

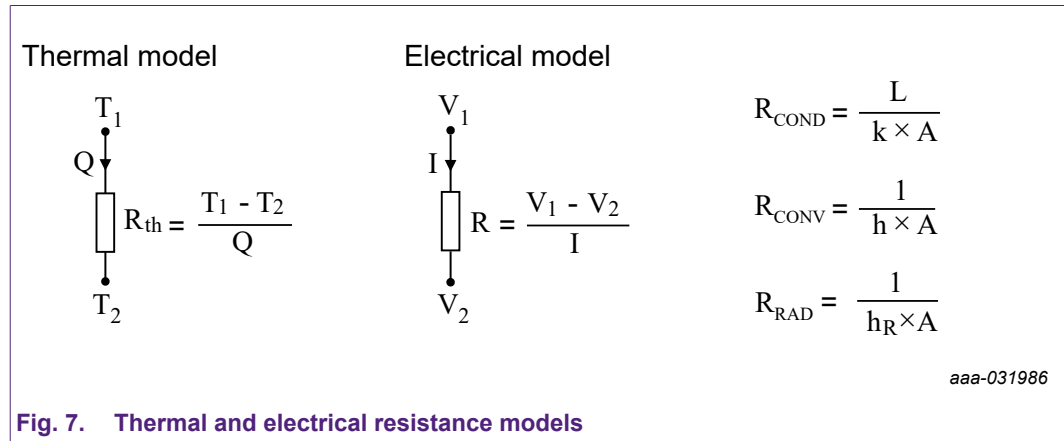

Fig. 7. Thermal and electrical resistance models

Every phenomenon governing how heat flows, namely conduction, convection and radiation, has its own thermal resistance. Each one of them depends inversely on a coefficient and surface or cross section area of the material from where heat is generated or simply passing through. In conduction the resistance depends directly to the length of the medium.

2.2.2. Thermal capacitance

Thermal capacitance, sometimes known also as thermal mass, is a property of a material which represents how much heat (thermal energy) it can store in time, similar to its electrical counterpart with electrical energy. Thermal capacitance provides also a quantity of the inertia against temperature fluctuations, the higher the value the harder it will be to drive the stored energy in or out.

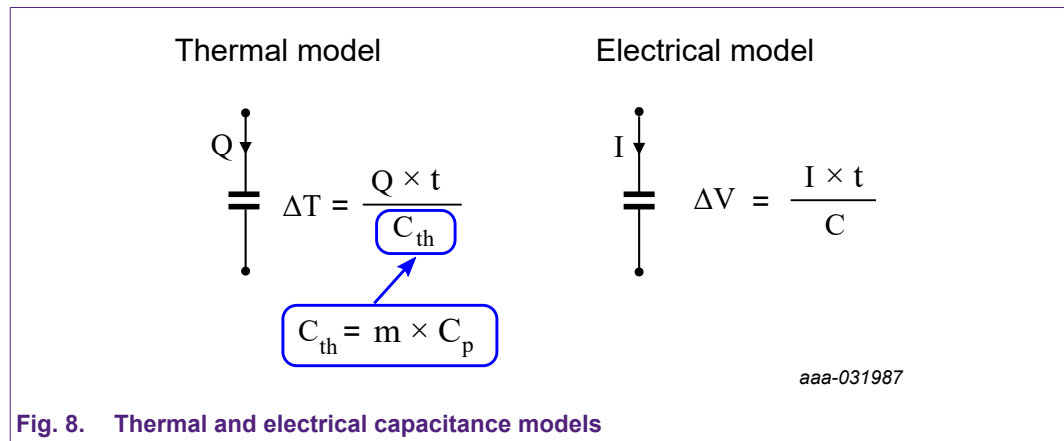

Fig. 8. Thermal and electrical capacitance models

Thermal capacitance is typically referred to using the symbol C_{th} , and it's measured as J/K. For a body of uniform composition, it can be approximated as the product of mass (m) of the body and specific heat capacity (C_p), which is the heat capacity of a sample of the substance divided by the mass of the sample.

2.2.3. Transient and steady state thermal behavior

- Thermal transients describe temperatures which are changing, even at the end of the analysis window. An example may be observed below in the yellow part of the junction temperature plot.
- Steady state thermals describe the stable region where temperatures show minimal to no change at all. These temperature remain unchanged with the passing of time and thus represent the final values a system might show under constant conditions.

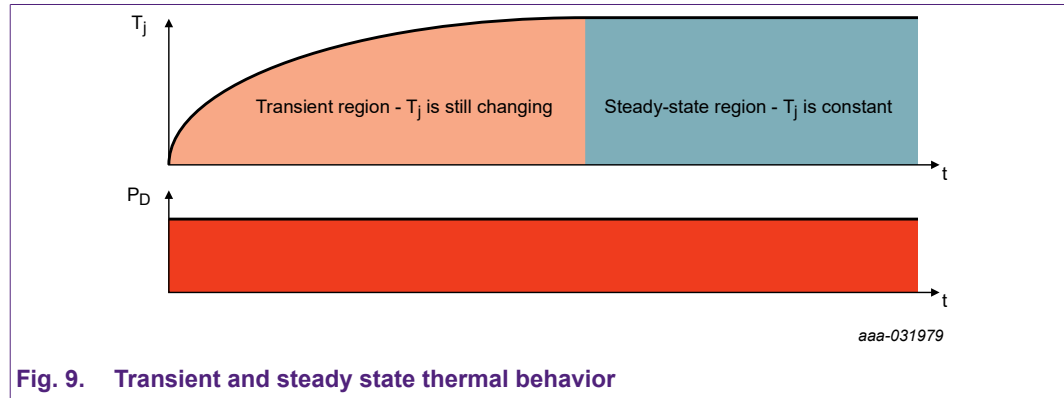

Fig. 9. Transient and steady state thermal behavior

2.3. MOSFET steady state thermal characteristics

This section focuses on two important MOSFET thermal aspects. The junction to mounting base thermal resistance as well as the junction to ambient thermal resistance. The aim in this chapter is to overview the two thermal paths and to show the thermal network which describes these paths.

2.3.1. Thermal resistance junction to mounting base - $R_{th(j-mb)}$

The thermal heat path between the MOSFET junction to its mounting base is one of the most important thermal specifications on a data sheet. It is represented by the overall junction to mounting base thermal resistance which is a value describing the ease with which heat is conducted along this path due to the different materials is going through. In Fig. 10, a MOSFET depiction is represented with the thermal resistive network between the junction to mounting base.

As the MOSFET and its parts are 3 dimensional so is the mentioned heat path, thus the 2 dimensional resistor network seen below is actually 3 dimensional in reality. Referring back to the $R_{th(j-mb)}$, it is important to remember that the value encompasses the whole network. Lastly, the parameter describes the steady state thermal characteristics, thus one should use average power dissipation values in order to obtain the temperatures reached by the MOSFET.

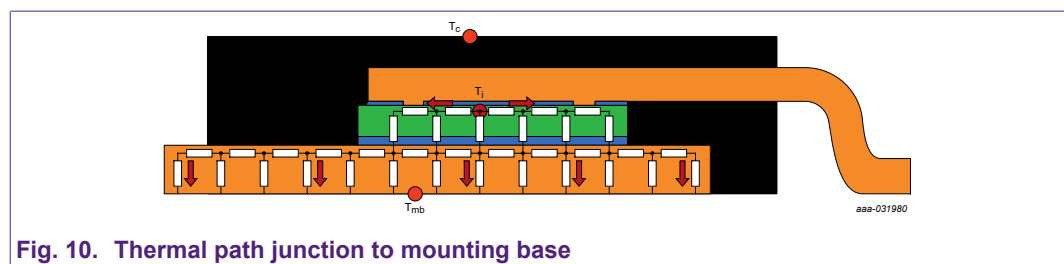

Fig. 10. Thermal path junction to mounting base

2.3.2. Thermal resistance junction to ambient - $R_{th(j-a)}$

The thermal heat path between the MOSFET junction and the ambient encompasses paths within the MOSFET itself as well as additional ones when a MOSFET is mounted onto a PCB. Hence, heat may spread from the junction towards the mounting base and the case. Afterwards, when the extremities of the MOSFET are reached, the heat will flow into the surroundings via the PCB or directly from the case. These heat paths are depicted in Fig. 11.

Fig. 11 a) shows the heat moving from the junction to the mounting base and to the case top and afterwards to the ambient. Fig. 11 b) shows the heat moving from the mounting base to the PCB and through it in order to reach the ambient.

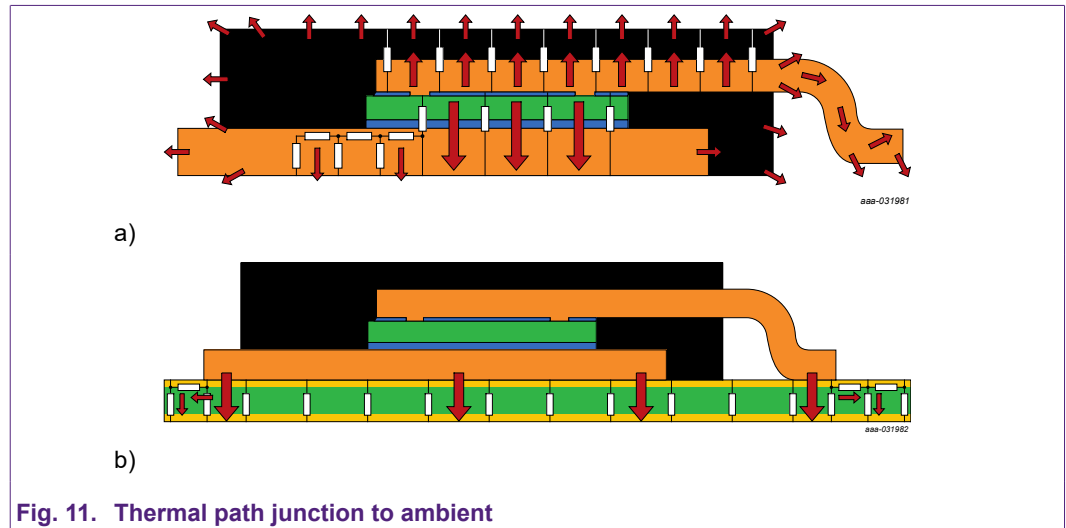

Fig. 11. Thermal path junction to ambient

A simplified thermal circuit may be seen in Fig. 12. It is important to notice that the two thermal paths from the component to the ambient are in parallel, thus improving both may be redundant.

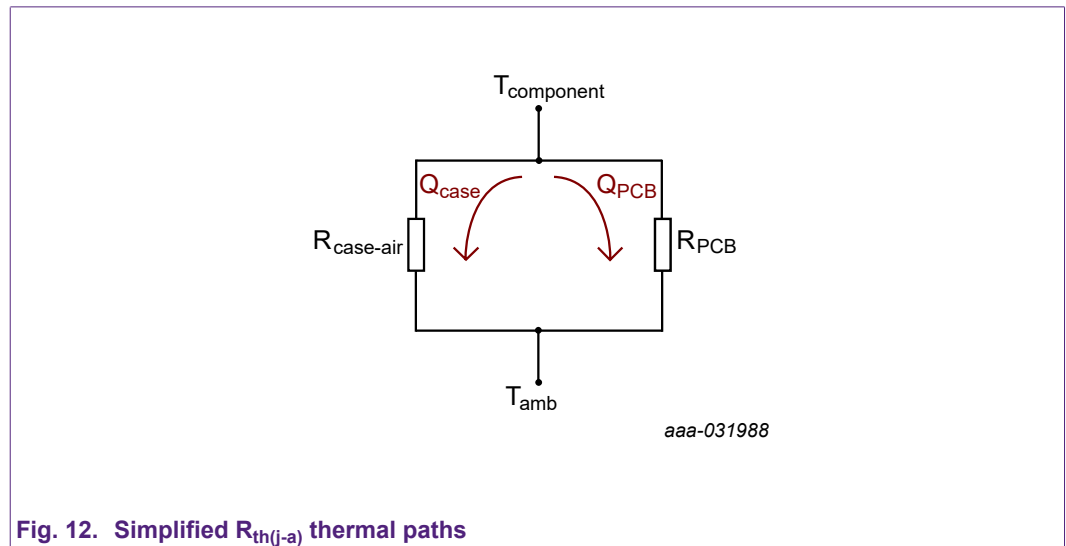

Fig. 12. Simplified $R_{th(j-a)}$ thermal paths

A more cost effective method of reducing the thermal resistance between the MOSFET to the surroundings may be to focus on one of the thermal paths and improve it in the best way possible.

Fig. 13 shows a thermal circuit which encompasses the MOSFET the PCB and the environment, it may be observed that the three heat spreading methods are shown by individual thermal resistors. In this particular case, the heat spreads:

- Through *conduction* from the junction towards the outside of the MOSFET, represented by the mounting base and the case.
- From the case to the ambient the heat propagates through *convection* and *radiation*.
- From the mounting base to the PCB and into it, *conduction* is again the main way of propagation.
- From the PCB into the environment *convection* and *conduction* are the main methods through which heat propagates to the ambient, radiation is usually negligible.

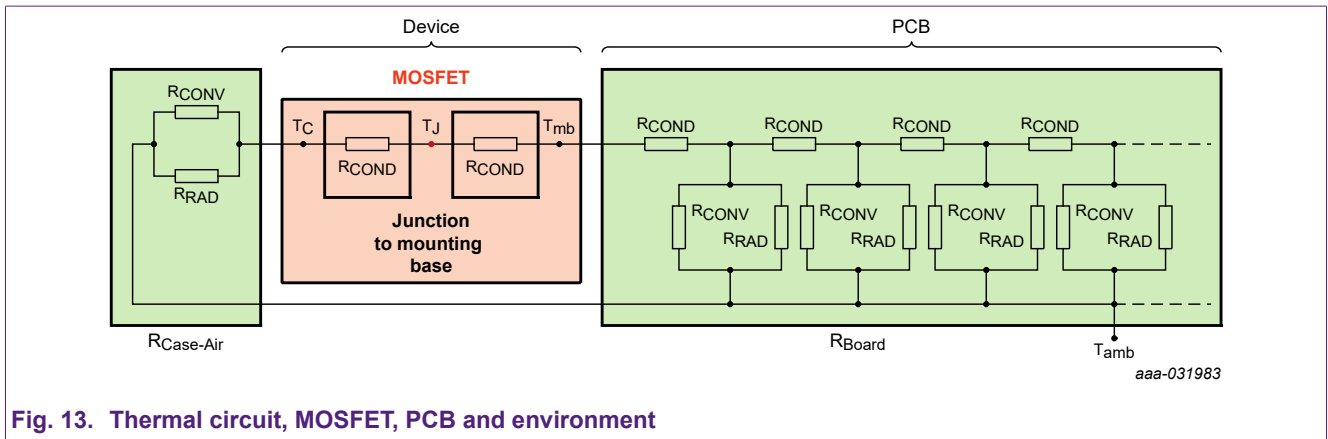

Fig. 13. Thermal circuit, MOSFET, PCB and environment

The thermal circuit seen in Fig. 13 is also represented in Fig. 1. Finally, the two thermal resistor networks highlighted in green are also represented in Fig. 12.

2.3.3. PCB thermal limitation and the 1 Watt rule

As previously described, the junction to ambient thermal path contains the board or PCB. This is often made from FR4 material, which from a thermal and electrical perspective is an insulator. Moreover, planes, pours and traces of copper are also present as these provide the circuit interconnections. Altogether we can consider them as forming the board and giving it a certain thermal characteristic called the board thermal resistance. It was found that this value is approximately **50-60 K/W**, depending on the amount of copper, insulation layer thickness and other factors. Since this is specific to the materials and dimensions of a board, this limit is imposed.

Moreover, the ambient temperature in which a board operates, the thermal limitations of a system, the FR4 temperature limit of 120 °C to 140 °C, as well as the temperature ranges within which a board needs to function in, gives rise to a power limitation. These same dependencies can be noted from the following equations:

$$\text{Thermal resistivity} \left[\frac{W}{mK} \right] = \frac{1}{\text{Thermal conductivity} \left[\frac{mK}{W} \right]} \tag{5}$$

$$\text{Thermal resistance} \left[\frac{K}{W} \right] = \text{Thermal resistivity} \left[\frac{W}{mK} \right] \times \frac{\text{Thickness} [m]}{\text{Area} [m^2]} \tag{6}$$

$$\text{Thermal resistance} \left[\frac{K}{W} \right] = \frac{\text{Temperature difference} [K]}{\text{Power} [m]} \tag{7}$$

PCB thickness, area and thermal resistivity determine the PCB thermal resistance, given in K/W. Hence, given a specific ambient temperature and a maximum FR4 temperature, or the system maximum operation temperature, a ΔT is obtained.

Example: calculate the power dissipation of a MOSFET mounted on an FR4 PCB within an automotive environment where the ambient temperature is 80 °C.

- The FR4 PCB material has a thermal resistance $R_{th(FR4\ PCB)} = 50\text{ K/W}$
- The FR4 PCB material maximum temperature ($T_{FR4(max)}$) = 130 °C
- The ambient temperature $T_{amb} = 80\text{ °C}$

$$\Delta T = T_{FR4(max)} - T_{(amb)} = 130\text{ °C} - 80\text{ °C} = 50\text{ °C} \quad (8)$$

$$P = \frac{\Delta T}{R_{th(FR4\ PCB)}} = \frac{50\text{ K}}{50\text{ K/W}} = 1\text{ W} \quad (9)$$

Given the above ambient temperature and FR4 PCB characteristics, approximately 1 watt of power may be dissipated in a MOSFET within this automotive environment.

2.3.4. Thermal nomenclature

Terminology surrounding thermal characterization of power MOSFETs has been revised multiple times over the years. Regardless of these efforts, standards organizations and semiconductor manufacturers may still use different names when referring to the same thermal parameter, or to slightly different variations of it. The terms often used to indicate one or the other type of thermal resistance are: R and θ . In the case of junction to ambient, the $R_{th(j-amb)} = R_{\theta(j-amb)} = \theta_{(j-amb)}$.

3. LPAK56D and LPAK33

3.1. Simple configuration with a single layer

In this section, we will present the maximum power dissipation results for a simple PCB configuration using a single layer with varying copper area.

Results for the LPAK56D and LPAK33 packages are given, for the LPAK56D with only one or with both MOSFETs conducting.

3.1.1. LPAK56D

Set-up:

- 1 layer on the top
- MOSFET power dissipation is 0.1 W, 0.5 W and 1 W applied to each MOSFET
- Maximum junction temperature of 175 °C
- PCB material is standard FR4, 1.6 mm thickness, dimension 100 x 100 mm
- Maximum PCB operating temperature of 120 °C
- Copper thickness is 2 oz./ft² (70 µm)
- The PCB is suspended in free air at ambient temperature of 20 °C
- The simulation is carried out for conduction, convection and radiation heat transfer
- There is no forced air cooling applied, i.e. only natural convection is modeled

The simplest possible PCB stack-up is that of a single top copper layer, see [Fig. 14](#).

In this analysis, we will examine the variation in device junction temperature (T_j) as a function of the top copper area.

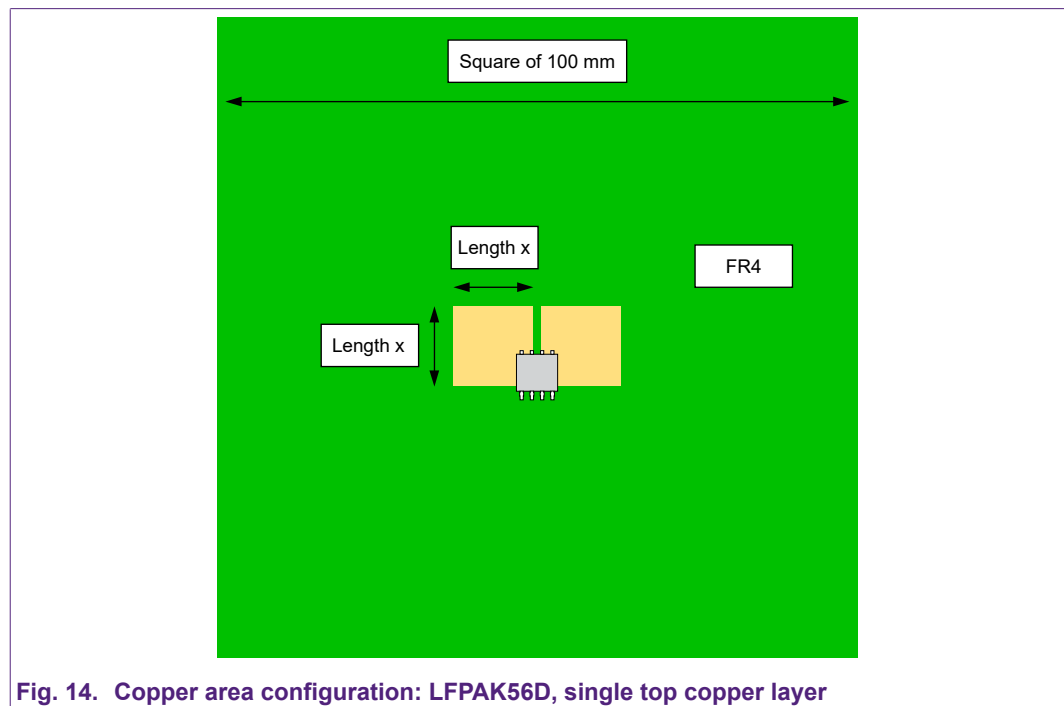

Fig. 14. Copper area configuration: LPAK56D, single top copper layer

The graph in [Fig. 15](#) captures two important factors:

- T_j depends greatly on length “x” and thus copper area, the bigger the area the better the thermal performance
- However, the ability of the top copper to provide heatsinking for the MOSFET shows a “law of diminishing returns”. In other words, we cannot keep on adding more copper area in the hope of

continuing to reduce T_j . As can be seen from Fig. 15 below, T_j will plateau at around 50 °C (for 0.5 W per MOSFET) no matter how much copper area we provide.

Care must be taken for T_j above 120 °C as PCB temperature directly under the transistor would be close to the MOSFET T_j .

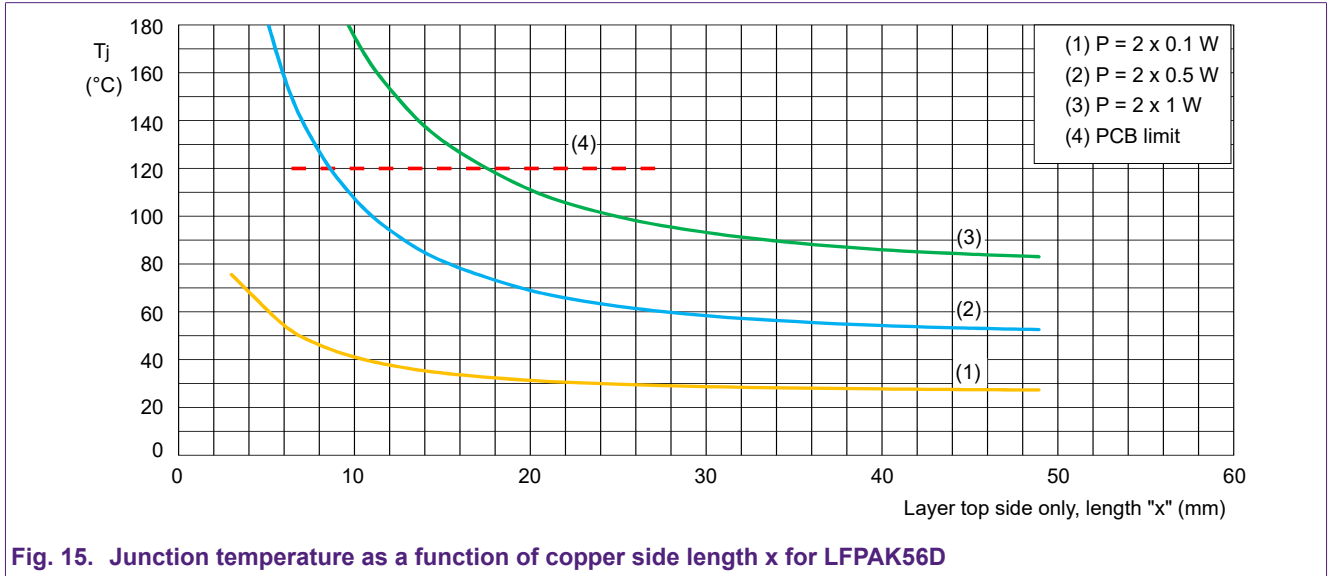

Fig. 15. Junction temperature as a function of copper side length x for LFPK56D

An alternative to the previous approach is to look at the maximum power allowed before reaching $T_{j(max)} = 175 \text{ °C}$ (MOSFET absolute max). Maximum power allowed is shown for different ambient temperature and copper length. In this example the PCB temperature was not considered so care must be taken for the resulting heat on the PCB.

In [Fig. 16](#) the maximum power for the conditions given is as follows:

$T_{amb} = 20\text{ °C}$: Max power is 2.6 W per MOSFET ($2 \times 2.6\text{ W}$ permissible in this package)

$T_{amb} = 80\text{ °C}$: Max power is 1.65 W per MOSFET ($2 \times 1.65\text{ W}$ permissible in this package)

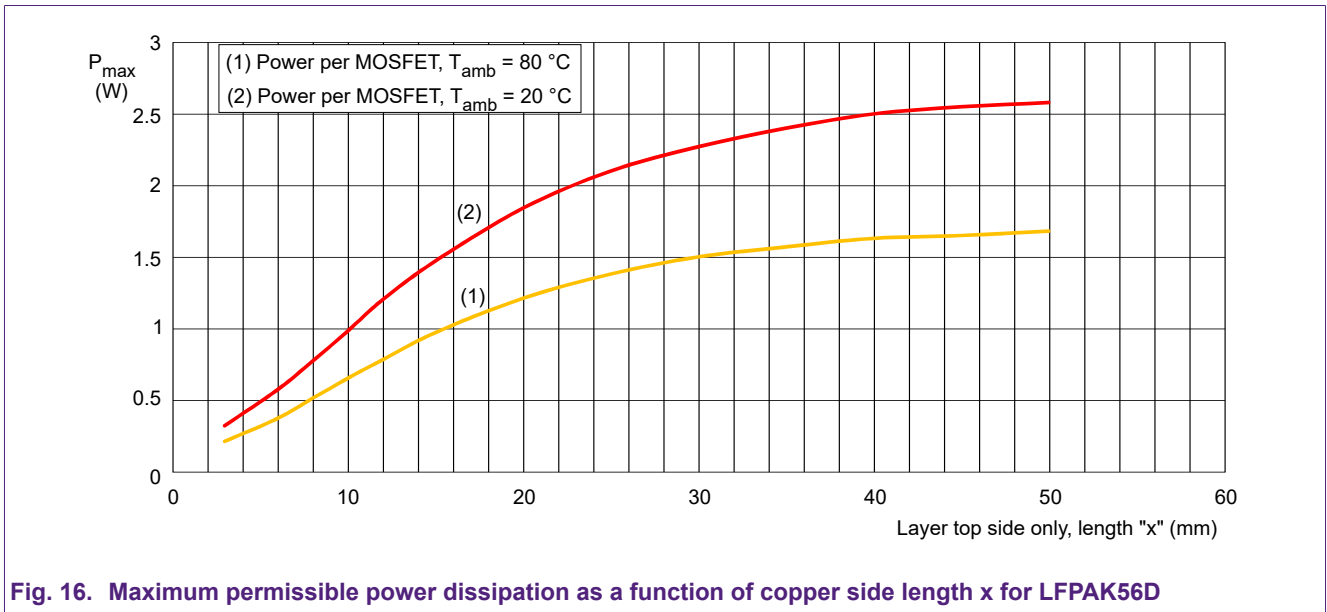

Fig. 16. Maximum permissible power dissipation as a function of copper side length x for LFPACK56D

3.1.2. LPAK56D only one MOSFET active at a time

In a typical half bridge application only one MOSFET conducts at a time. In the graph below, Fig. 17, 1 W is dissipated in the left MOSFET (blue curve). We can see that 1 W dissipation in one MOSFET is not equivalent to 0.5 W dissipation in each of the two MOSFETs (yellow curve).

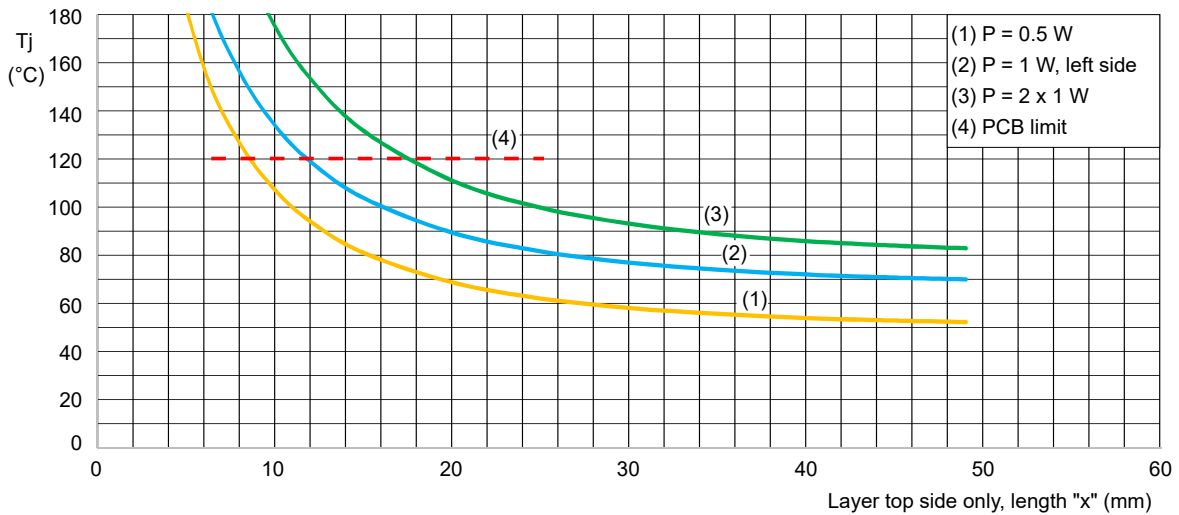

Fig. 17. Junction temperature as a function of copper side length x for LPAK56D; one MOSFET conducting

As can be seen temperature is higher in the case of one MOSFET dissipating 1 W than it is with two MOSFETs each dissipating 0.5 W. When only one MOSFET is active the second MOSFET does not make a significant contribution to the total dissipation capability - meaning that if one MOSFET is off the heating is not shared equally between the two. This is further explained by the thermal network shown in Fig. 19.

An alternative to the previous approach is to look at the maximum power allowed before reaching $T_{j(max)} = 175\text{ °C}$ (MOSFET absolute max). Maximum power allowed is shown for different ambient temperature and copper length. In this example the PCB temperature was not considered so care must be taken for the resulting heat on the PCB. In Fig. 18 the maximum power for the conditions given is as follows:

- $T_{amb} = 20\text{ °C}$: Max power is 3.35 W with only left MOSFET
- $T_{amb} = 80\text{ °C}$: Max power is 2.1 W with only left MOSFET

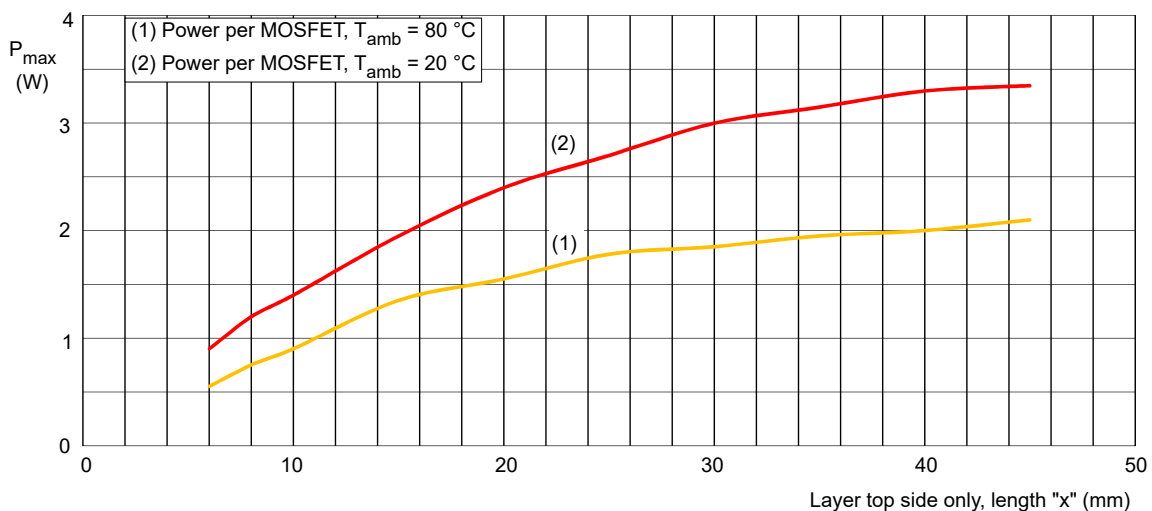
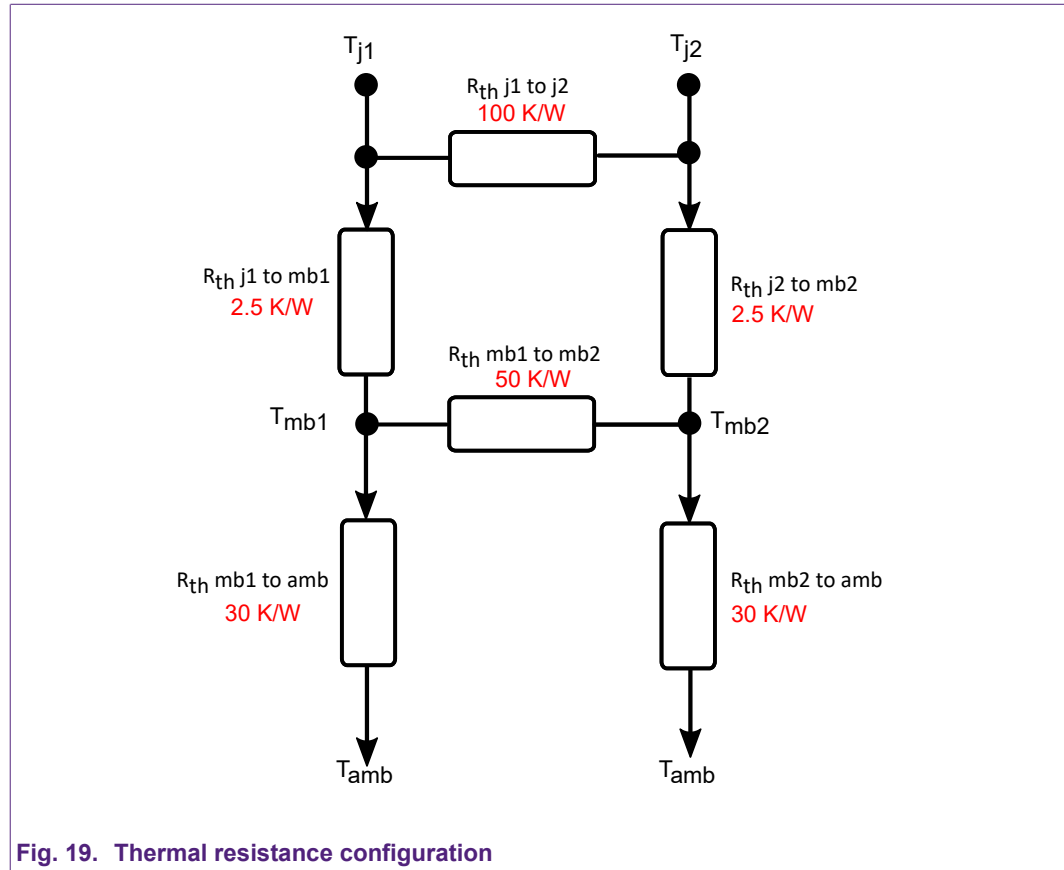

Fig. 18. Maximum power as a function of side length x for LPAK56D; one MOSFET conducting

The concept of the second MOSFET half-sharing the thermal dissipation when turned off is not true – see [Fig. 19](#)

Dual MOSFET thermal resistance configuration:

We can see that the thermal path between both MOSFETs inside the package is highly resistive (100 K/W).



3.1.3. LFPACK33

Set-up:

- 1 layer on the top
- MOSFET power dissipation is 0.1 W, 0.5 W and 1 W applied in the MOSFET
- Maximum junction temperature of 175 °C
- PCB material is standard FR4, 1.6 mm thickness, dimension 100 x 100 mm
- Maximum PCB operating temperature of 120 °C
- Copper thickness is 2 oz./ft² (70 μm)
- The PCB is suspended in free air at ambient temperature of 20 °C
- The simulation is carried out for conduction, convection and radiation heat transfer
- There is no forced air cooling applied i.e. only natural convection is modeled

The simplest possible PCB stack-up is that of a single top copper layer. In this analysis, we will examine the variation in device junction temperature (T_j) as a function of top copper area.

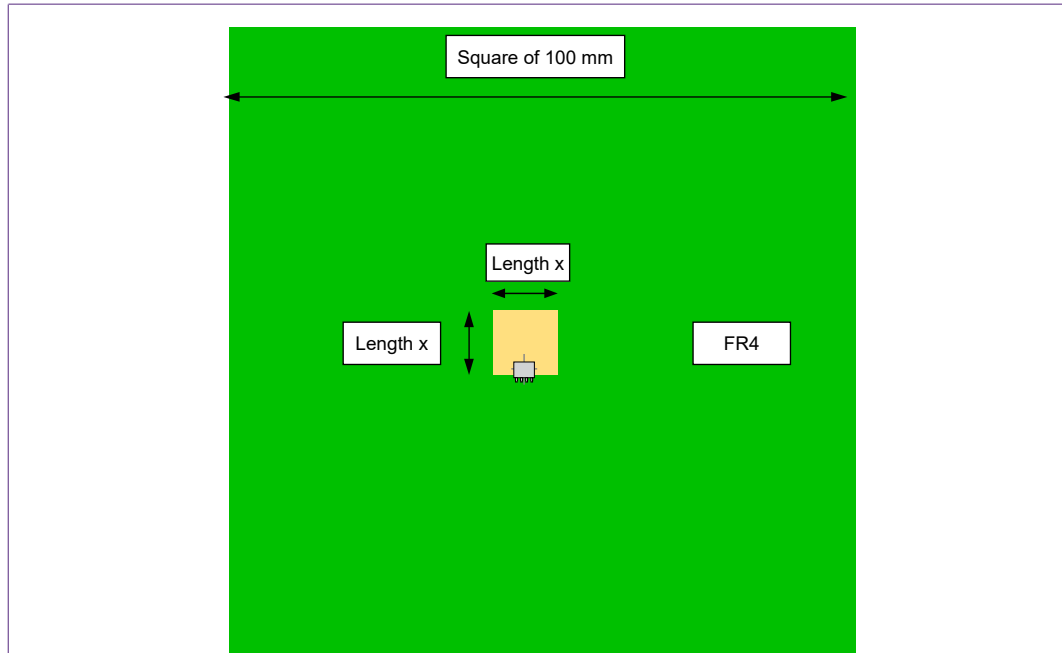

Fig. 20. Copper area configuration: LFPACK33, single top copper layer

The graph in Fig. 21 captures two important factors:

- T_j depends greatly on length “x” and thus copper area, the bigger the area the better the thermal performance
- However, the ability of the top copper to provide heatsinking for the MOSFET shows a “law of diminishing returns”. In other words, we cannot keep on adding more copper area in the hope of continuing to reduce T_j . As can be seen from Fig. 21 below, T_j will plateau at around 40 °C (for 0.5 W per MOSFET) no matter how much copper area we provide.

Care must be taken for T_j above 120 °C as PCB temperature directly under the transistor would be close to the MOSFET T_j .

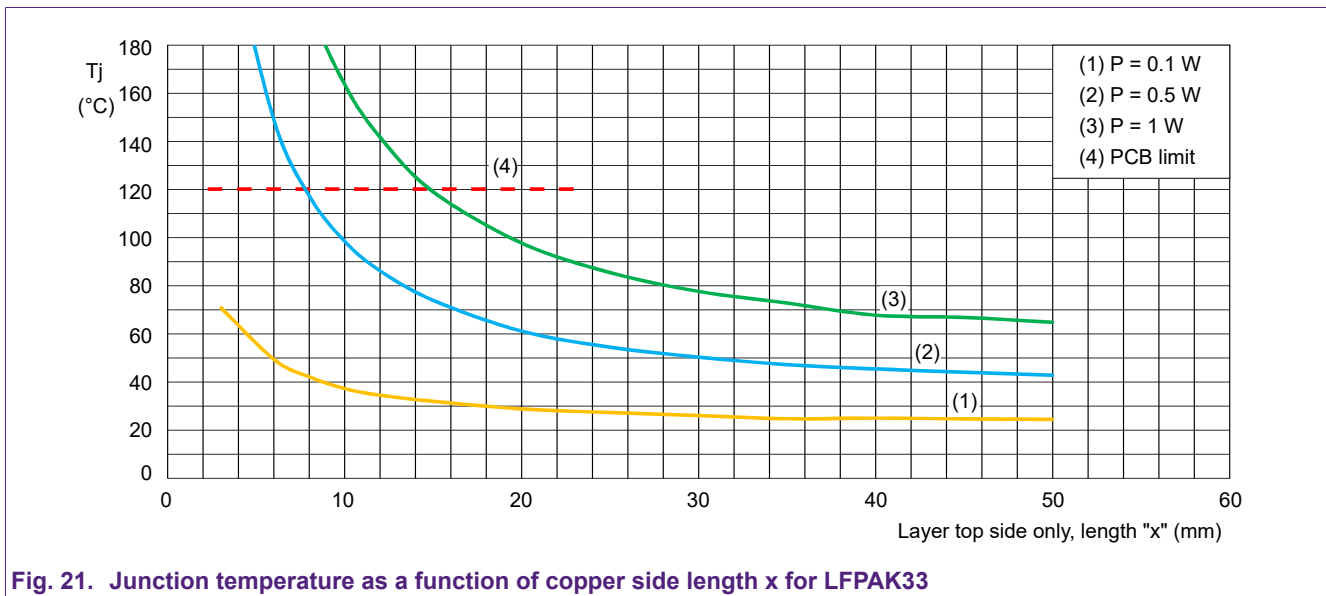

Fig. 21. Junction temperature as a function of copper side length x for LFPACK33

An alternative to the previous approach is to look at the maximum power allowed before reaching $T_{j(max)} = 175$ °C (MOSFET absolute max). Maximum power allowed is shown for different ambient temperature and copper length. In this example the PCB temperature was not considered so care must be taken for the resulting heat on the PCB.

In the graph below, [Fig. 22](#), the maximum power for the conditions given is as follows:

$T_{amb} = 20\text{ }^{\circ}\text{C}$: Max power is 3.7 W in the MOSFET

$T_{amb} = 80\text{ }^{\circ}\text{C}$: Max power is 2.4 W in the MOSFET

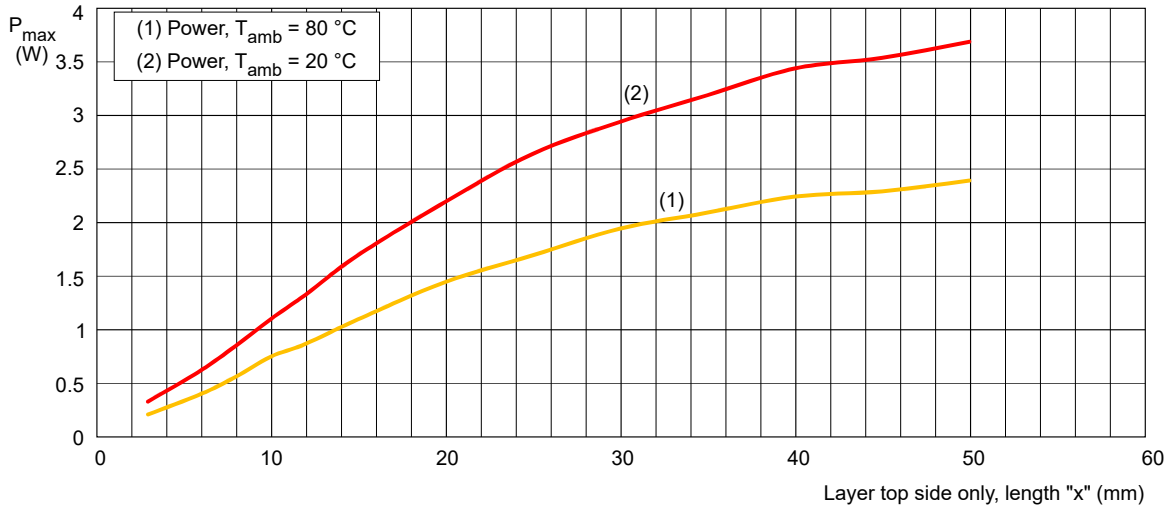

Fig. 22. Maximum permissible power dissipation as a function of copper side length x for LFPACK33

3.2. Usual configuration: 4 layers + vias

In this section, we will present the maximum power dissipation results for a PCB configuration using 4 layers + vias for dissipation on the bottom layer, with varying copper area.

Results for the LPAK56D and LPAK33 packages are given, for the LPAK56D with only one or with both MOSFETs conducting.

3.2.1. LPAK56D

Set-up:

- 4 layers + vias (vias number increases with the copper area with a maximum of 25 vias for each side)
- MOSFET power dissipation is 0.1 W, 0.5 W and 1 W applied to each MOSFET
- Maximum junction temperature of 175 °C
- PCB material is standard FR4, 1.6 mm thickness, dimension 100 x 100 mm
- Maximum PCB operating temperature of 120 °C
- Copper thickness on all layers (external and internal) is 2 oz./ft² (70 μm)
- The PCB is suspended in free air at ambient temperature of 20 °C
- The simulation is carried out for conduction, convection and radiation heat transfer
- There is no forced air cooling applied i.e. only natural convection is modeled

The common PCB stack-up is 4 layers with vias under MOSFETs to create a dissipation path to the heatsink.

In this analysis, we will examine the variation in device junction temperature (T_j) as a function of top copper area. In [Fig. 23](#) below, we can see the vias configuration:

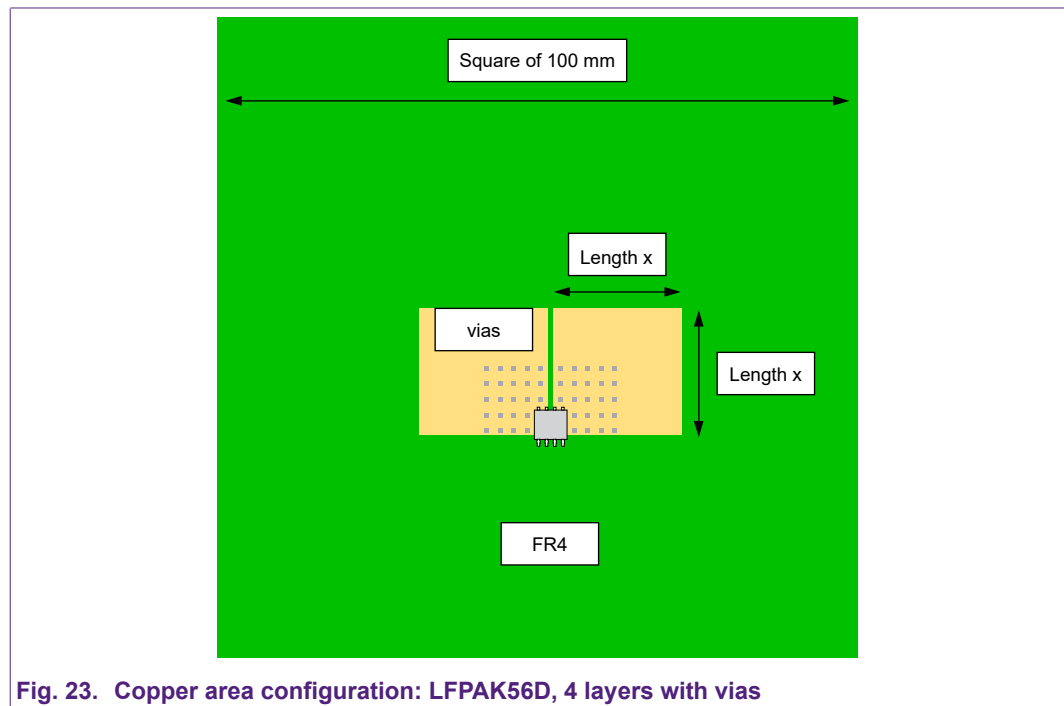

Fig. 23. Copper area configuration: LPAK56D, 4 layers with vias

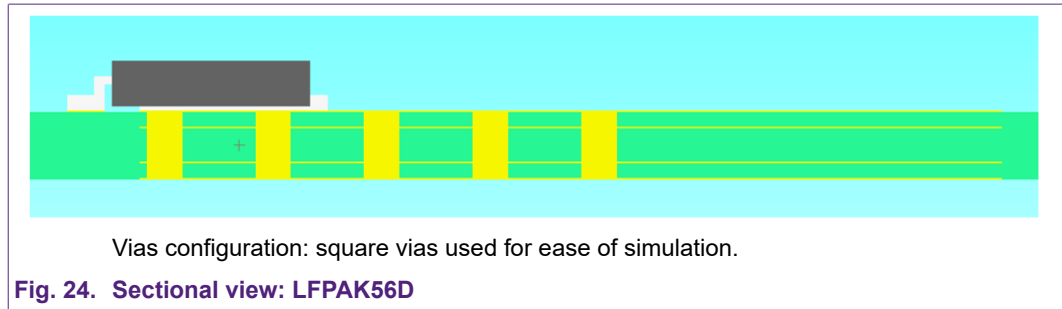

Table 5. Limitation of number of vias

X (mm)	vias configuration		
minimal footprint	2+2 vias	Maximum number of vias able to be inserted in the copper surface	Vias pitch 2.5 mm Vias side length 0.7 mm Copper thickness 70 μm No solder fill
6	9+9 vias		
8	12+12 vias		
10	20+20 vias		
15	25+25 vias	25 vias maximum	
20	25+25 vias		
25	25+25 vias		
30	25+25 vias		
35	25+25 vias		
40	25+25 vias		
50	25+25 vias		

The graph in Fig. 25 captures two important factors:

- T_j depends greatly on length “x” and thus copper area, the bigger the area the better the thermal performance
- However, the ability of the top copper to provide heatsinking for the MOSFET shows a “law of diminishing returns”. In other words, we cannot keep on adding more copper area in the hope of continuing to reduce T_j . As can be seen from the graph in Fig. 25, T_j will plateau at around 36 °C (for 0.5 W per MOSFET) no matter how much copper area we provide.

Care must be taken for T_j above 120 °C as the PCB temperature directly under the transistor would be close to the MOSFET T_j .

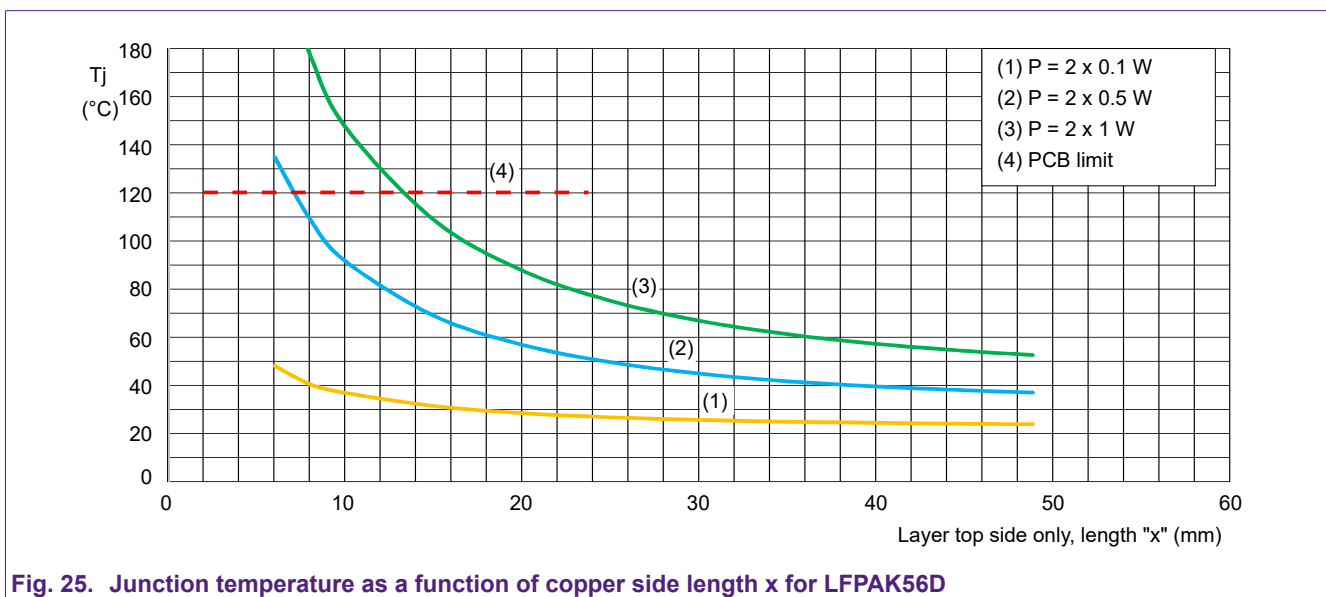

An alternative to the previous approach is to look at the maximum power allowed before reaching $T_{j(max)} = 175\text{ °C}$ (MOSFET absolute max). Maximum power allowed is shown for different ambient temperature and copper length. In this example the PCB temperature was not considered so care must be taken for the resulting heat on the PCB.

In the graph below, [Fig. 26](#) the maximum power for the conditions given is as follows:

$T_{amb} = 20\text{ °C}$: Max power is 5.3 W per MOSFET ($2 \times 5.3\text{ W}$ permissible in this package)

$T_{amb} = 80\text{ °C}$: Max power is 3.55 W per MOSFET ($2 \times 3.55\text{ W}$ permissible in this package)

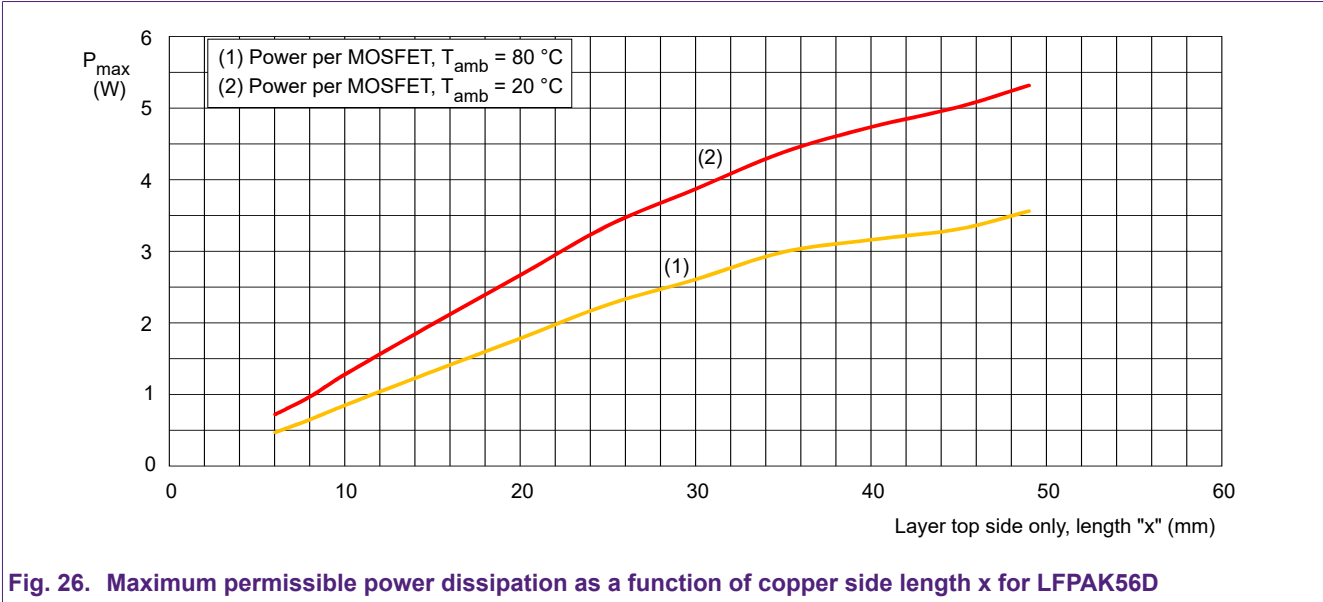

Fig. 26. Maximum permissible power dissipation as a function of copper side length x for LFPK56D

3.2.2. LFPAK56D only one MOSFET active at a time

In a typical half bridge application only one MOSFET conducts at a time. Fig. 27 below shows the results for 1 W applied to the left MOSFET (blue curve). We can see that 1 W dissipated in one MOSFET is not equivalent to 0.5 W dissipation in each of the two MOSFETs (yellow curve).

As can be seen temperature is higher in the case of one MOSFET conducting with 1 W than it is with two MOSFETs each dissipating 0.5 W.

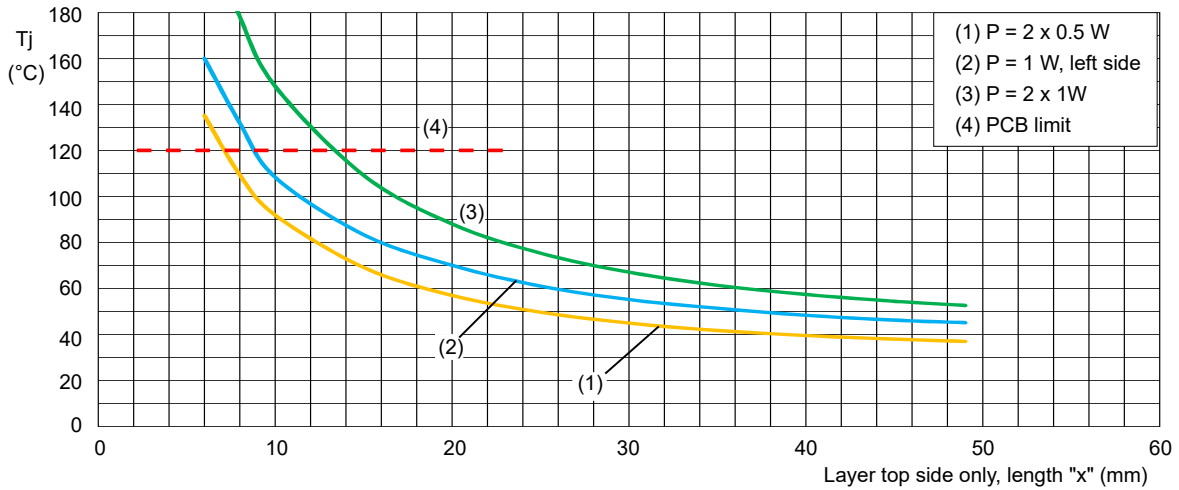

Fig. 27. Junction temperature as a function of copper side length x for LFPAK56D; one MOSFET

An alternative to the previous approach is to look at the maximum power allowed before reaching $T_{j(max)} = 175\text{ °C}$ (MOSFET absolute max). Maximum power allowed is shown for different ambient temperature and copper length. In this example the PCB temperature was not considered so care must be taken for the resulting heat on the PCB.

In Fig. 28 the maximum power for the conditions given is as follows:

- $T_{amb} = 20\text{ °C}$: Max power is 6 W with only left MOSFET
- $T_{amb} = 80\text{ °C}$: Max power is 4 W with only left MOSFET

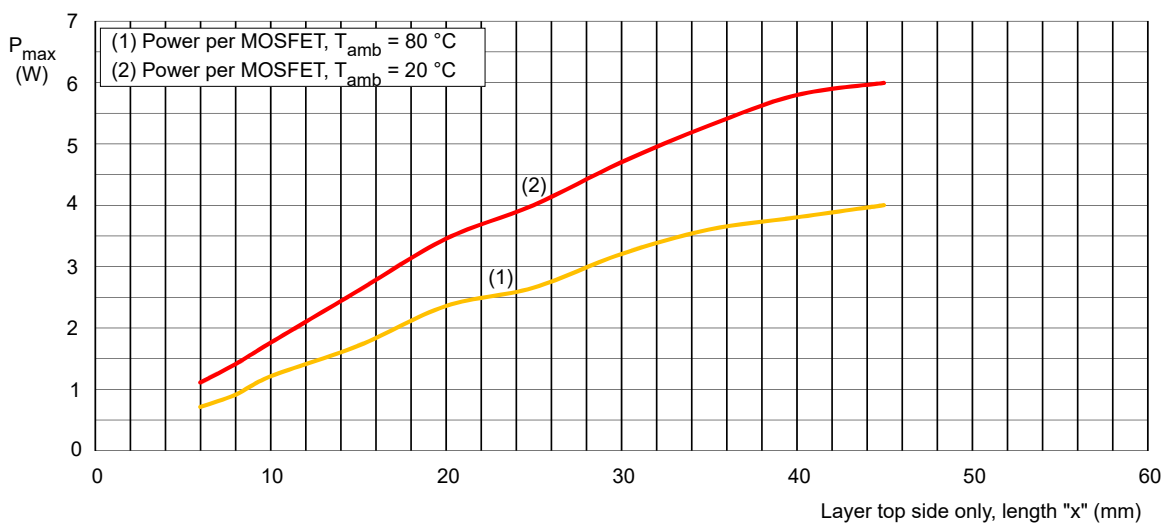

Fig. 28. Power dissipation as a function of copper side length x for LFPAK56D; one MOSFET

As previously mentioned, when only one MOSFET is active the second MOSFET does not make a significant contribution to the total dissipation capability – see [Fig. 19](#).

3.2.3. LFPACK33

Set-up:

- 4 layers + vias (vias number increases with the copper area with a maximum of 25 vias for each side)
- MOSFET power dissipation is 0.1 W, 0.5 W and 1 W applied in the MOSFET
- Maximum junction temperature of 175 °C
- PCB material is standard FR4, 1.6 mm thickness, dimension 100 x 100 mm
- Maximum PCB operating temperature of 120 °C
- Copper thickness on all layers (external and internal) is 2 oz./ft² (70 μm)
- The PCB is suspended in free air at ambient temperature of 20 °C
- The simulation is carried out for conduction, convection and radiation heat transfer
- There is no forced air cooling applied i.e. only natural convection is modeled

The common PCB stack-up is 4 layers with vias under the MOSFETs to create a dissipation path to the heatsink.

In this analysis, we will examine the variation in device junction temperature (T_j) as a function of top copper area.

In [Fig. 29](#) below, we can see the vias configuration:

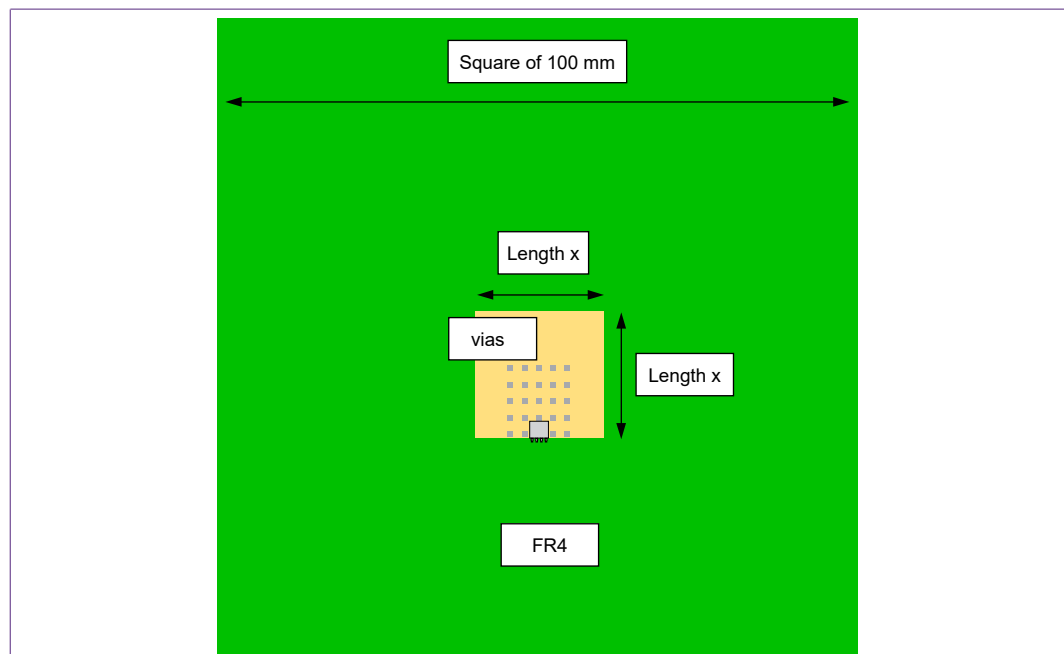

Fig. 29. copper area configuration: LFPACK33, 4 layers with vias

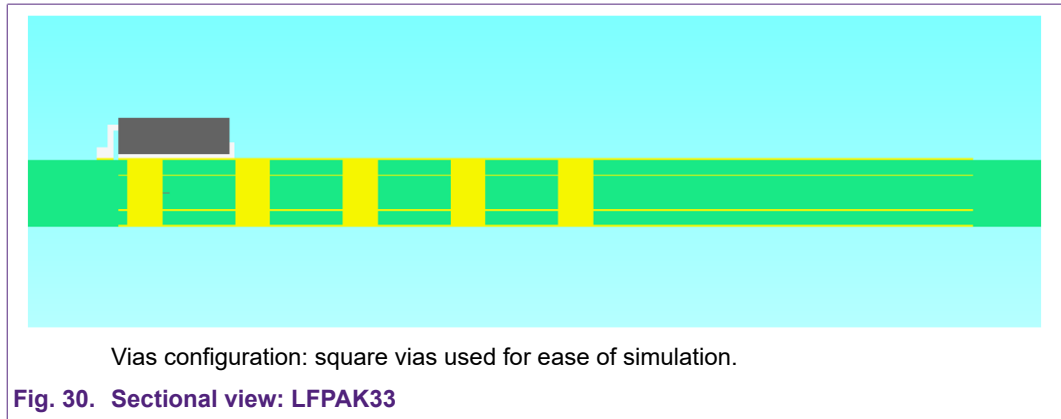

Table 6. Vias configuration

X (mm)	vias configuration		
minimal footprint	1 via	Maximum number of vias able to be inserted in the copper surface	Vias pitch 2.5 mm Vias side length 0.7 mm Copper thickness 70 μm No solder fill
6	6 vias		
8	9 vias		
10	20 vias		
15	25 vias	25 vias maximum	
20	25 vias		
25	25 vias		
30	25 vias		
35	25 vias		
40	25 vias		
50	25 vias		

The graph [Fig. 31](#) captures two important factors:

- T_j depends greatly on length “x” and thus copper area, the bigger the area the better the thermal performance
- However, the ability of the top copper to provide heatsinking for the MOSFET shows a “law of diminishing returns”. In other words, we cannot keep on adding more copper area in the hope of continuing to reduce T_j . As can be seen from [Fig. 31](#) below T_j will plateau at around 33 °C (for 0.5 W per MOSFET) no matter how much copper area we provide.

Care must be taken for T_j above 120 °C as PCB temperature directly under the transistor would be close to the MOSFET T_j .

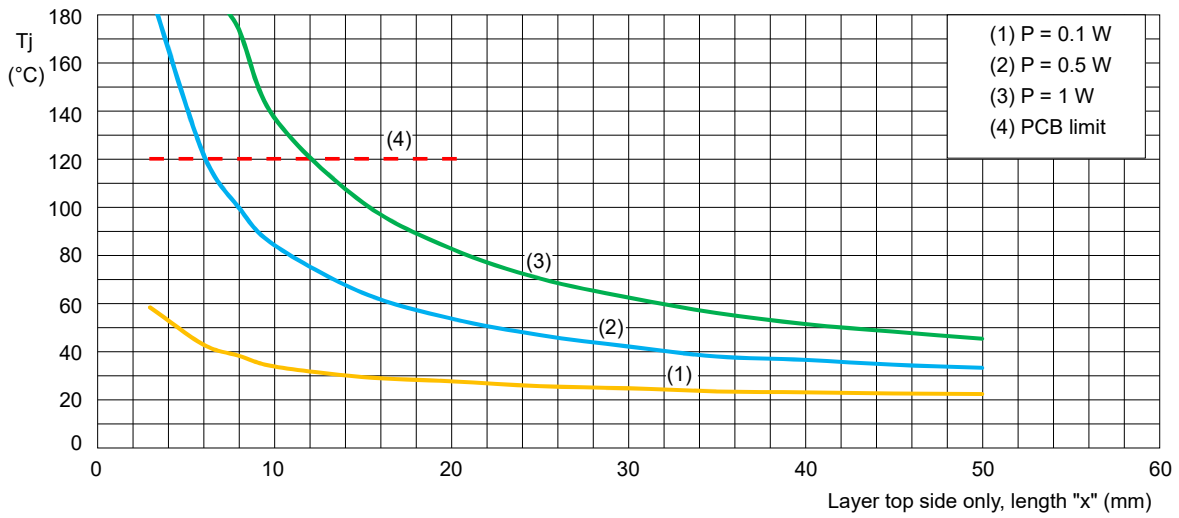

Fig. 31. Junction temperature as a function of copper side length x for LFPAK33

An alternative to the previous approach is to look at the maximum power allowed before reaching $T_{j(max)} = 175\text{ °C}$ (MOSFET absolute max). Maximum power allowed is shown for different ambient temperature and copper length. In this example the PCB temperature was not considered so care must be taken for the resulting heat on the PCB.

In the graph below the maximum power for the conditions given is as follows:

$T_{amb} = 20\text{ °C}$: Max power is 6.5 W in the MOSFET

$T_{amb} = 80\text{ °C}$: Max power is 4.3 W in the MOSFET

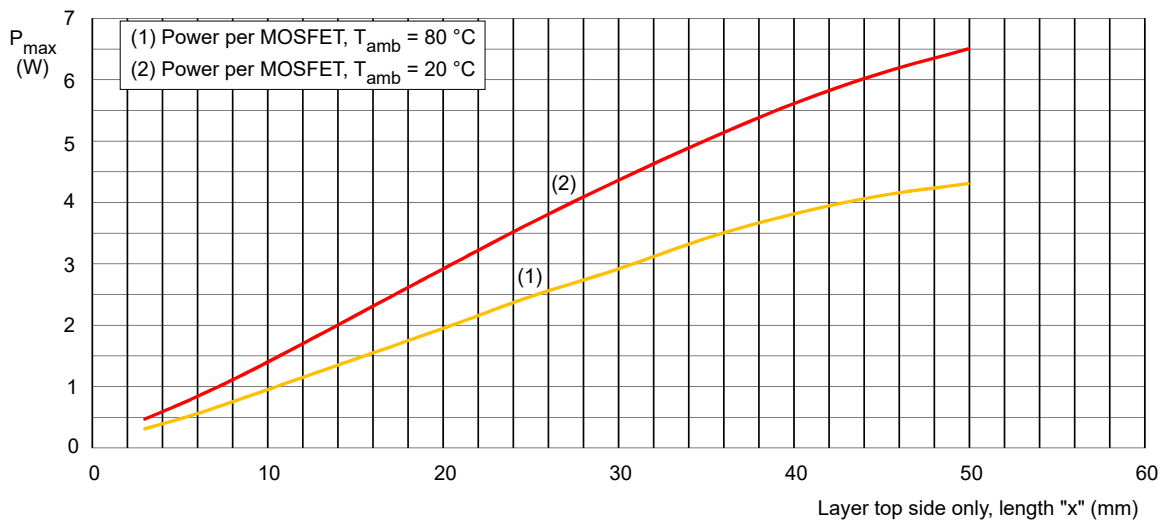

Fig. 32. Maximum permissible power dissipation as a function of copper side length x for LFPAK33

3.3. Placement advice for improved dissipation

In this section, we will present some results for two MOSFETs placed close to each other on a single layer PCB with varying copper area.

3.3.1. LPAK56D

Simulation of two MOSFETs placed next to each other is carried out and checked against results seen in [section 2.1](#). The aim is to understand the dissipation effect that the two LPAK56D have on one another.

Set-up

- 1 layer on the top side
- MOSFET power dissipation is 0.5 W applied to each MOSFET
- Maximum junction temperature of 175 °C
- PCB material is standard FR4, 1.6 mm thickness, dimension 200 x 150 mm
- Maximum PCB operating temperature of 120 °C
- Copper thickness on all layers (external and internal) is 2 oz./ft² (70 μm)
- The PCB is suspended in free air at ambient temperature of 20 °C
- The simulation is carried out for conduction, convection and radiation heat transfer
- There is no forced air cooling applied i.e. only natural convection is modeled

The simplest possible PCB stack-up is that of a single top copper layer. In this analysis, we will examine the variation in device junction temperature (T_j) as a function of top copper area.

- 2 mm gap between right and left copper layers
- Simulation carried out for different length “x”
- 0.5 W applied on each internal MOSFET

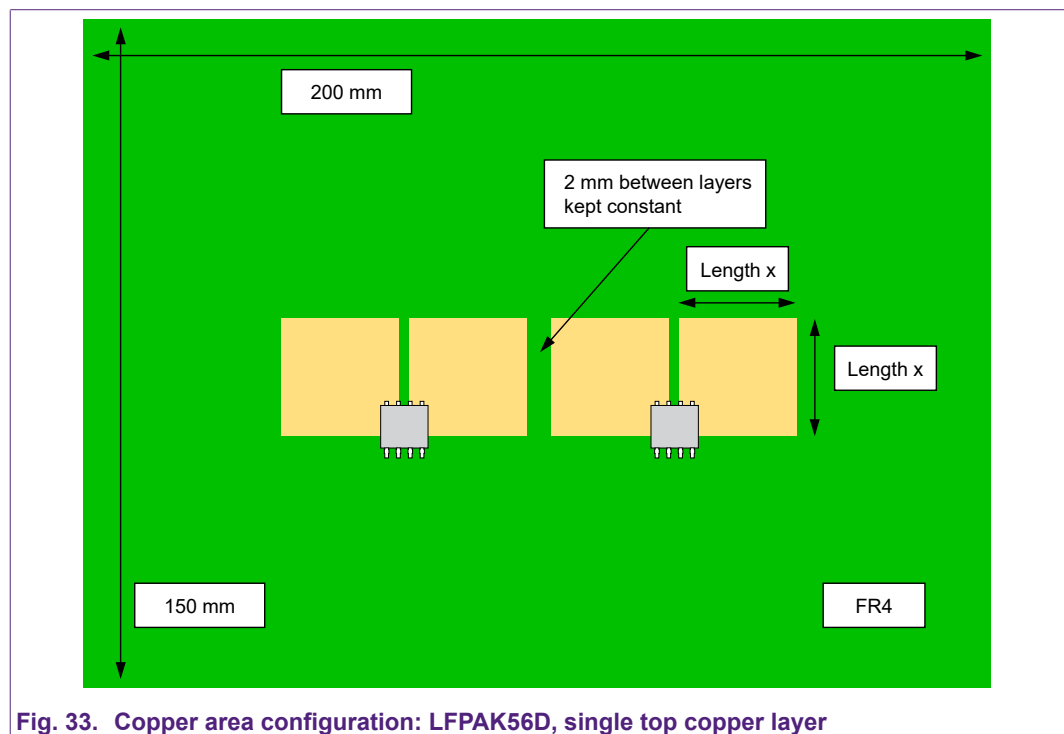

Fig. 33. Copper area configuration: LPAK56D, single top copper layer

The graph in [Fig. 34](#) shows:

- The results (in green) are similar to the ones observed in [section 2.1](#) (slightly higher +3 °C)
- This is due to the low conductivity of FR4, despite only 2 mm gap it showed no heat transfer from one copper area to the other

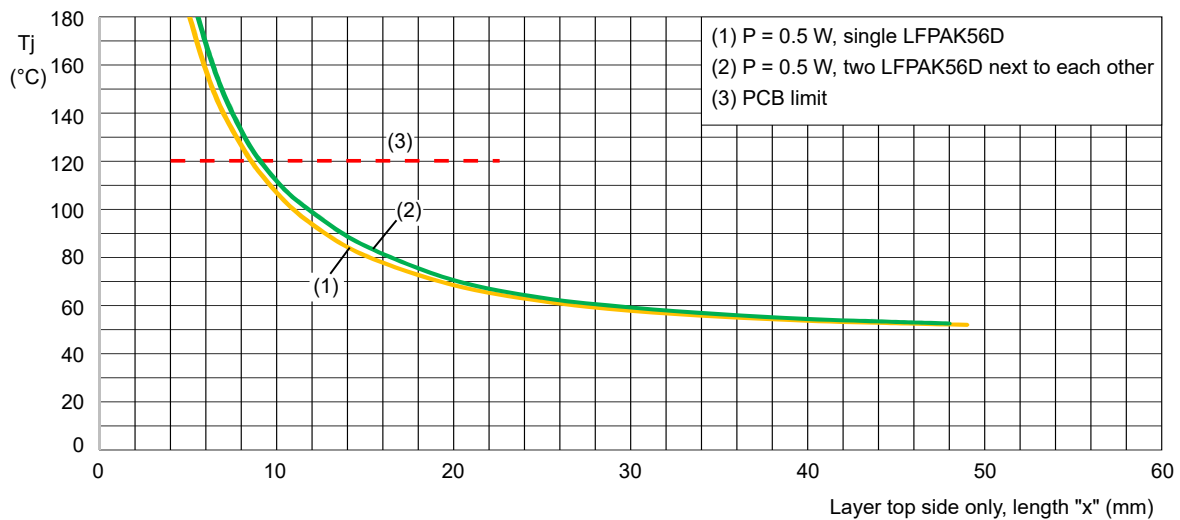

Fig. 34. Junction temperature as a function of copper side length x for 2 LFPAK56D

3.3.2. LFPAK33

Simulation of two MOSFETs placed next to each other is carried out and checked against results seen in [section 2.3](#). The aim is to understand the dissipation effect that the two MOSFETs have on one another.

Set-up:

- 1 layer on the top
- MOSFET power dissipation is 0.5 W applied in the MOSFET
- Maximum junction temperature of 175 °C
- PCB material is standard FR4, 1.6 mm thickness, dimension 200 x 150 mm
- Maximum PCB operating temperature of 120 °C
- Copper thickness is 2 oz./ft² (70 μm)
- The PCB is suspended in free air at ambient temperature of 20 °C
- The simulation is carried out for conduction, convection and radiation heat transfer
- There is no forced air cooling applied i.e. only natural convection is modeled

The simplest possible PCB stack-up is that of a single top copper layer. In this analysis, we will examine the variation in device junction temperature (T_j) as a function of top copper area.

- 2 mm gap between right and left copper layers
- Simulation carried out for different length "x"
- 0.5 W applied on each MOSFET

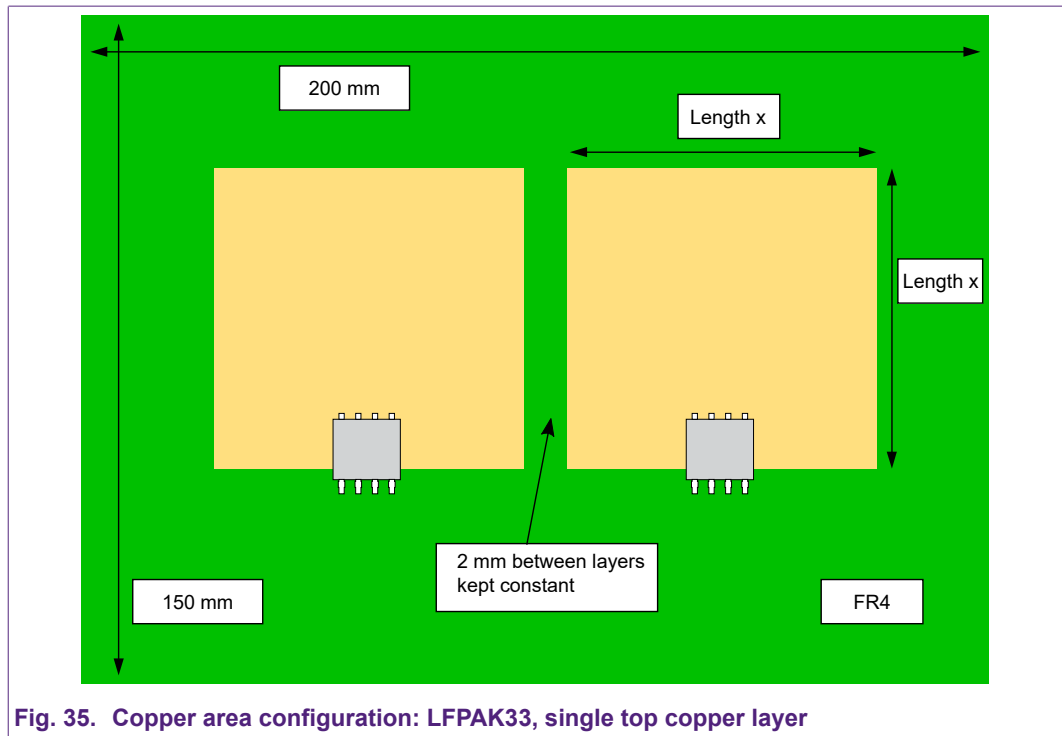

Fig. 35. Copper area configuration: LFPAK33, single top copper layer

The graph in [Fig. 37](#) shows:

- The results for $x > 20$ mm are similar to the ones observed in [section 2.3](#) (slightly higher +3 °C)
- This is due to the low conductivity of FR4, despite only 2 mm gap it showed no heat transfer from one copper area to the other
- For $x < 20$ mm results show up to 20 °C higher compared to the results from [section 2.3](#).
- This is due to the MOSFETs being brought closer to each other as a result of reduced copper area – note that in this case the space between MOSFETs is half the space between MOSFETs in the case of LFPAK56D

In [Fig. 36](#) you can see that for $x = 10$ mm, the distance between the LFPAK33 MOSFETs is approximately 10 mm. Less than 20 mm apart, the MOSFETs are close enough to heat each other, hence we start to see a temperature difference.

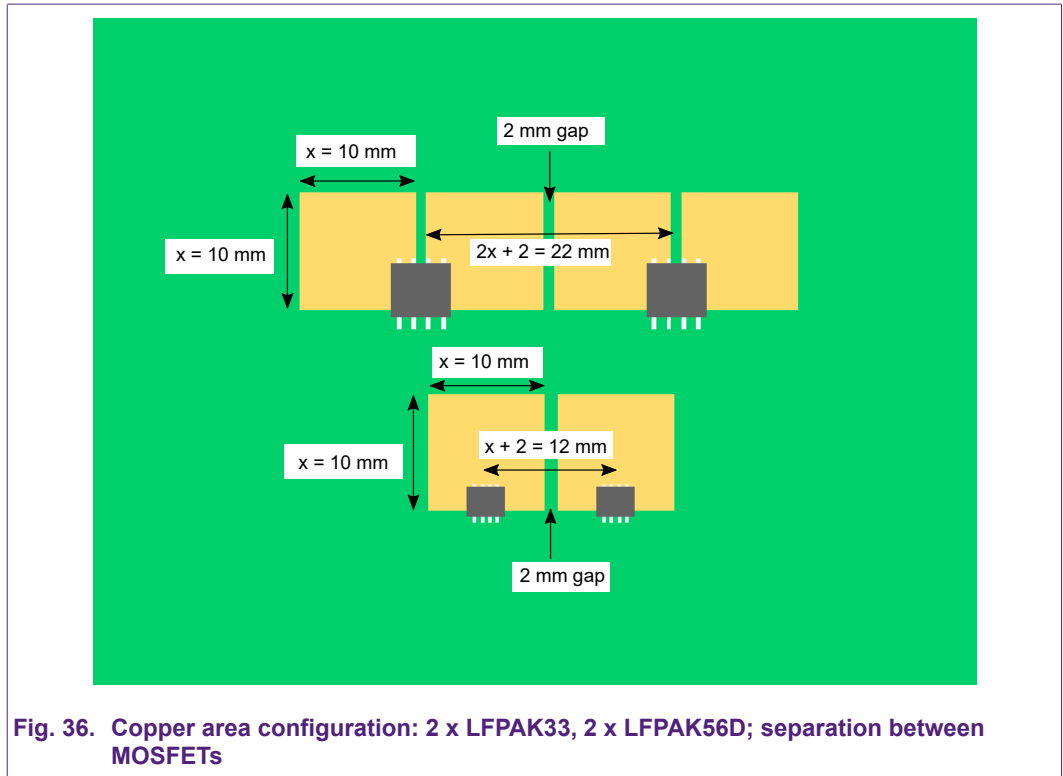

Fig. 36. Copper area configuration: 2 x LPAK33, 2 x LPAK56D; separation between MOSFETs

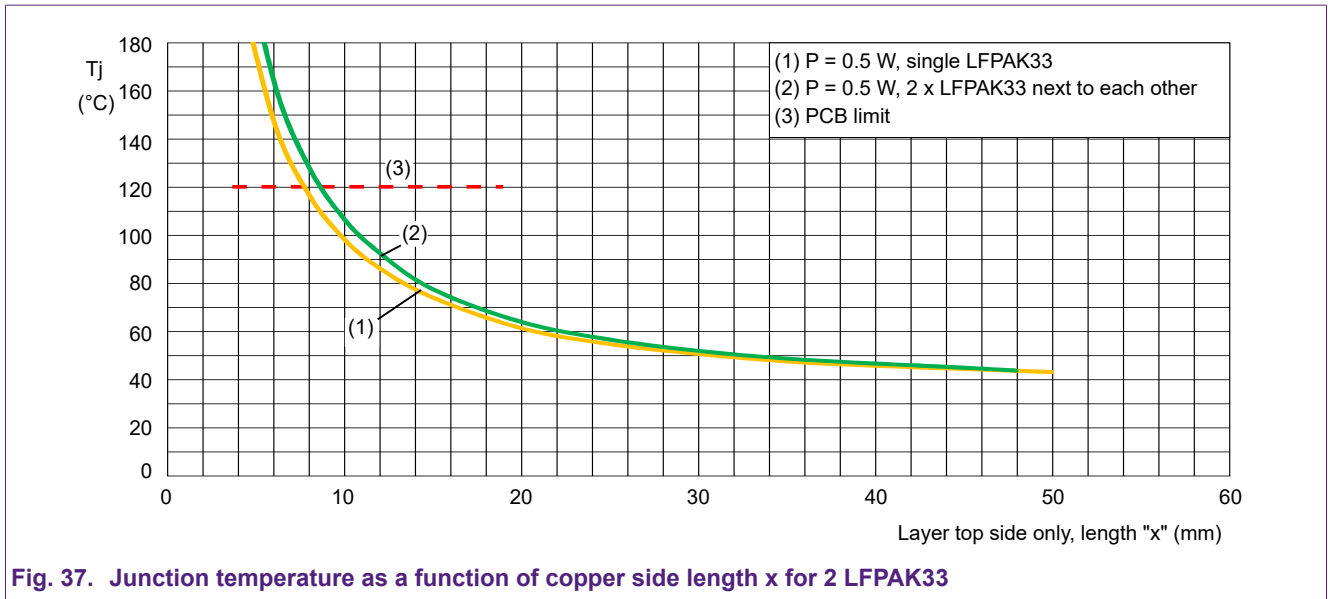

Fig. 37. Junction temperature as a function of copper side length x for 2 LPAK33

3.4. Comparison between two LPAK56 and one LPAK56D, then one LPAK56D and two LPAK33

In this section we will present some comparative results for different package devices on a single layer board with varying copper area.

3.4.1. Two LPAK56 to LPAK56D

In this section the results of two single LPAK56 MOSFETs are compared to the results of one dual LPAK56D MOSFET (see [Section 3.1.1](#))

The aim is to highlight the benefit of using one LPAK56D dual MOSFET instead of two single LPAK56 MOSFETs.

Set-up:

- 1 layer on the top
- MOSFET power dissipation is 0.5 W applied to each MOSFET
- Maximum junction temperature of 175 °C
- PCB material is standard FR4, 1.6 mm thickness, dimension 100 x 100 mm
- Maximum PCB operating temperature of 120 °C
- Copper thickness is 2 oz./ft² (70 µm)
- The PCB is suspended in free air at ambient temperature of 20 °C
- The simulation is carried out for conduction, convection and radiation heat transfer
- There is no forced air cooling applied, i.e. only natural convection is modeled

The simplest possible PCB stack-up is that of a single top copper layer. In this analysis, we will examine the variation in device junction temperature (T_j) as a function of top copper area.

- Same gap between copper layer was used for both single LPAK56 and dual LPAK56D
- Simulation carried out for different length “x”.
- 0.5 W applied on each MOSFET

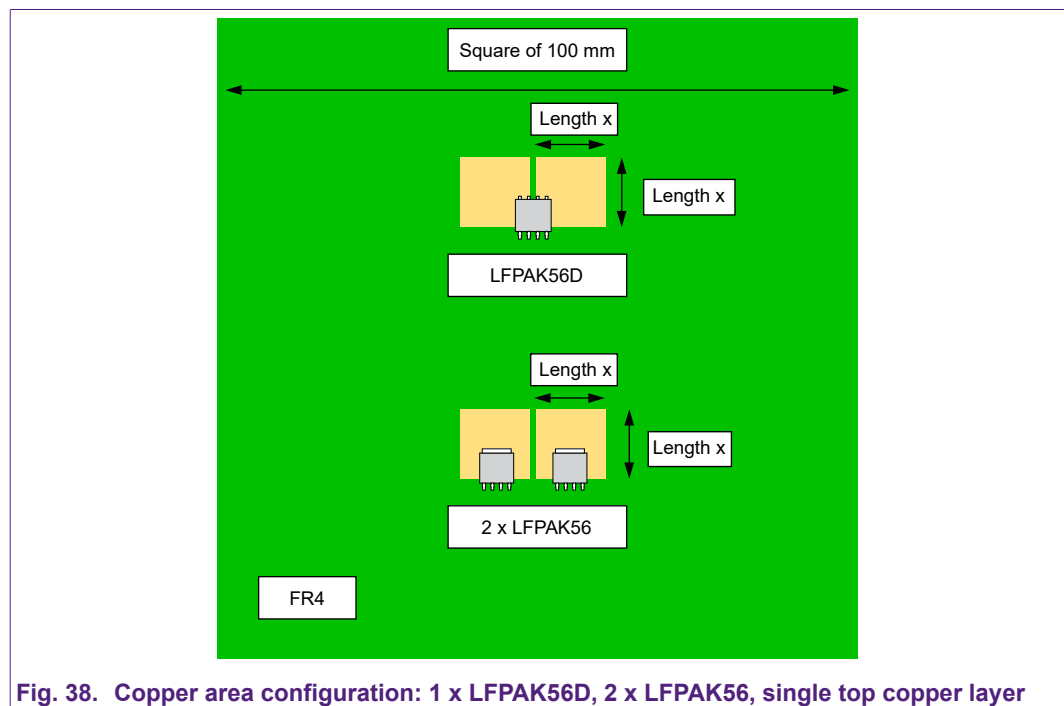

Fig. 38. Copper area configuration: 1 x LPAK56D, 2 x LPAK56, single top copper layer

The graph in [Fig. 39](#) shows:

- Overall two single LPAK56 show better heat dissipation than one dual LPAK56D by up to approximately 10 °C. This is due to the larger surface area of the LPAK56 drain tab giving improved heat spreading and thermal dissipation.

- Note that the 10 °C is the relative figure between the two packages, the most important factor is the operating junction temperature
- If there is enough margin before reaching 175 °C at the junction, then LFPK56D offers an attractive option due to its space saving

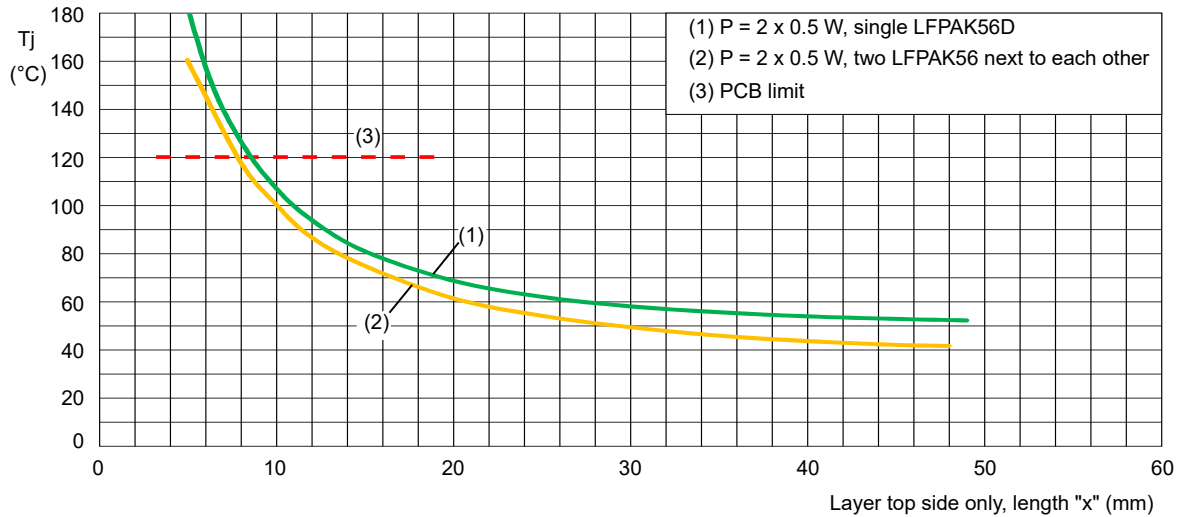

Fig. 39. Junction temperature as a function of copper side length x for 2 LFPK56 and 1 LFPK56D

3.4.2. LFPK56D to two LFPK33

In this section the results of one dual LFPK56D MOSFET are compared to the results of two single LFPK33 MOSFETs (see [section 4.2](#))

Aim is to highlight the benefit of using one LFPK56D dual instead of two single LFPK33.

Set-up:

- 1 layer on the top
- MOSFET power dissipation is 0.5 W applied to each MOSFET
- Maximum junction temperature of 175 °C
- PCB material is standard FR4, 1.6 mm thickness, dimension 100 x 100 mm
- Maximum PCB operating temperature of 120 °C
- Copper thickness is 2 oz./ft² (70 μm)
- The PCB is suspended in free air at ambient temperature of 20 °C
- The simulation is carried out for conduction, convection and radiation heat transfer
- There is no forced air cooling applied, i.e. only natural convection is modeled

The simplest possible PCB stack-up is that of a single top copper layer. In this analysis, we will examine the variation in device junction temperature (T_j) as a function of top copper area.

- Same gap between copper layer was used for both single LFPK33 and dual LFPK56D
- Simulation carried out for different length "x"
- 0.5 W applied on each MOSFET

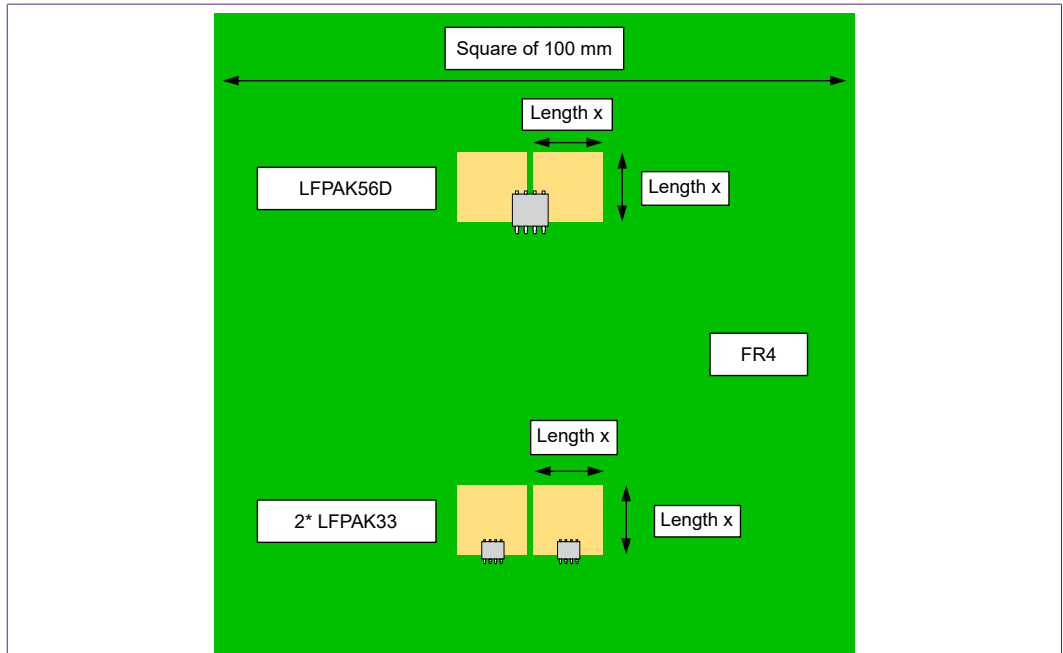

Fig. 40. Copper area configuration: 1 x LFLPAK56D, 2 x LFLPAK33, single top copper layer

The graph in Fig. 41 shows:

- Overall two single LFLPAK33 show better heat dissipation than a dual LFLPAK56D by up to approximately 5 °C. This is due to the larger drain surface area of the LFLPAK33 offering better thermal dissipation, (less improvement than with LFLPAK56 as LFLPAK33 is a smaller package).
- Note that the 5 °C is the relative figure between the two packages, the most important factor is the operating junction temperature.
- If there is enough margin before reaching 175 °C at the junction, then LFLPAK56D offers an attractive option due to all the advantages that one component offers versus two in terms of PCB layout, placement, cost effectiveness, etc.

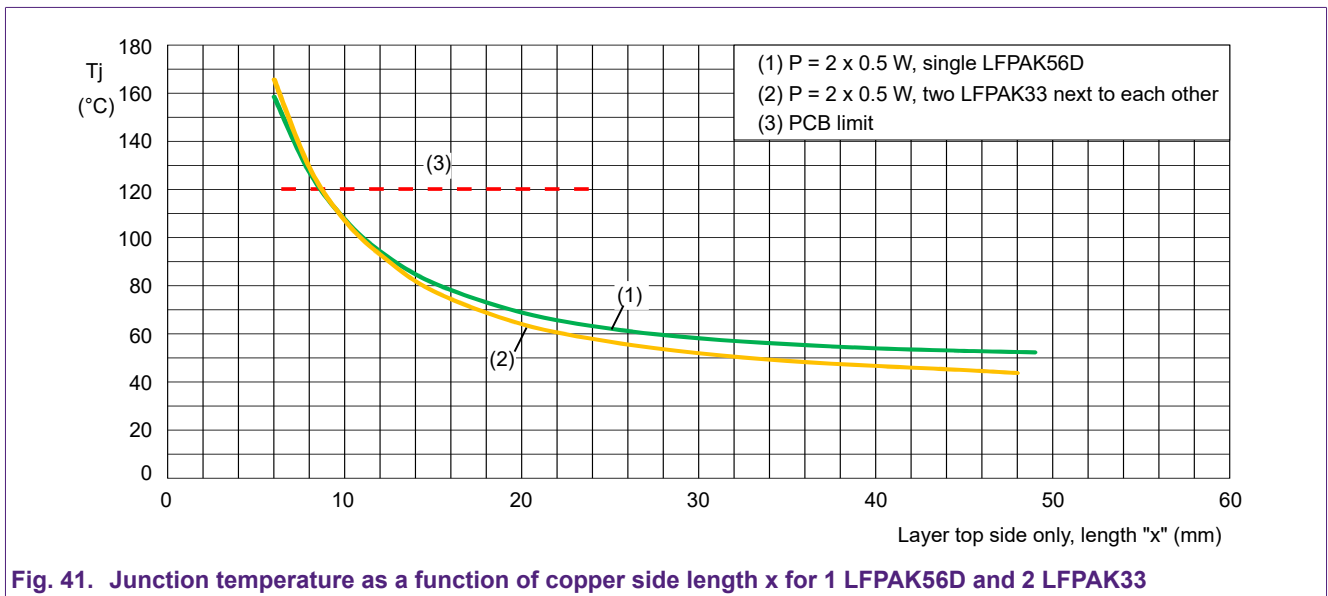

Fig. 41. Junction temperature as a function of copper side length x for 1 LFLPAK56D and 2 LFLPAK33

3.5. Impact of $R_{th(j-mb)}$ compared to $R_{th(mb-a)}$

Dissipation losses from the MOSFET junction are not mainly limited by the thermal resistance $R_{th(j-mb)}$ as this is very low. The high thermal path for heat dissipation is presented by the thermal resistance $R_{th(mb-amb)}$ (mounting base to PCB to ambient).

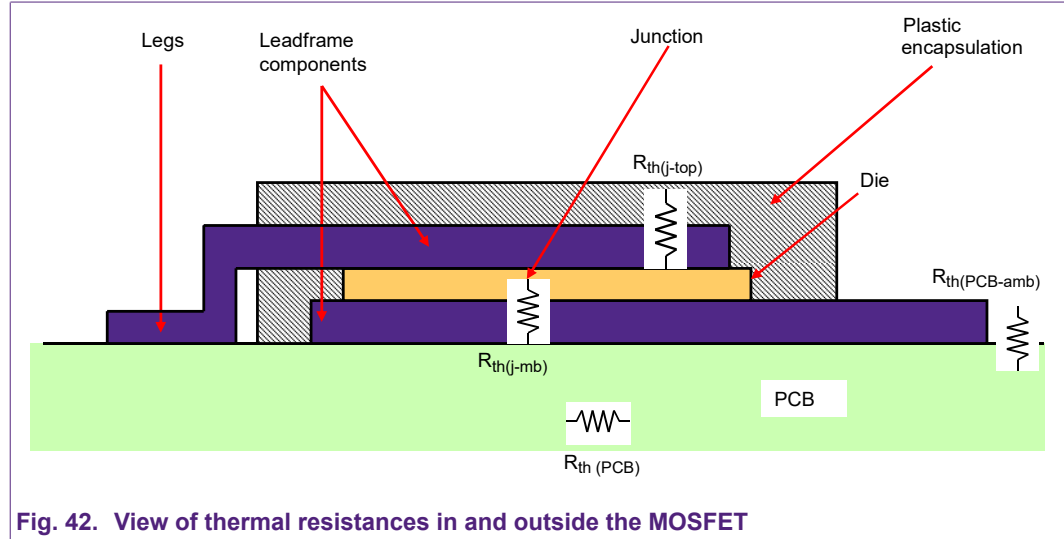

Fig. 42. View of thermal resistances in and outside the MOSFET

Example: for the part number BUK7M15-60E (LPAK33, 15 mΩ, 60 V) the maximum thermal resistance junction to mounting base is 2.43 K/W:

Table 7. Thermal resistance BUK7M15-60E

Symbol	Parameter	Conditions	Min	Typ	Max	Unit
$R_{th(j-mb)}$	thermal resistance from junction to mounting base	Fig. 5	-	2.01	2.43	K/W

Using thermal simulation (Flotherm) with the following conditions:

0.5 W of losses in the MOSFET, air ambient is 20 °C, 35 μm copper, we can calculate some thermal resistance.

- $R_{th(j-mb)}$ is 0.8 K/W
 - This is a lower value than given in the data sheet due to the simulation using ideal conditions
- As can be seen in Table 8 below, thermal resistance for other items have high value compared $R_{th j-mb}$
- The total thermal resistance, junction to ambient, is 59.4 K/W when using 65.4 °C as (ambient) reference point.

Table 8 lists temperatures for different points captured in the simulation and shown in Fig. 43.

Table 8. Breakdown of thermal resistance for a simple case

Thermal resistance part	Temperature (°C)	R_{th} (K/W)
Junction	95.1	-
Mounting base	94.7	0.8
PCB under MOSFET	88.6	12.2
PCB to the right of the MOSFET	86.6	4
Ambient air 0.5 mm over the top of the PCB	79.1	15

Thermal resistance part	Temperature (°C)	R _{th} (K/W)
Ambient air 1 mm over the top of the PCB	65.4	27.4

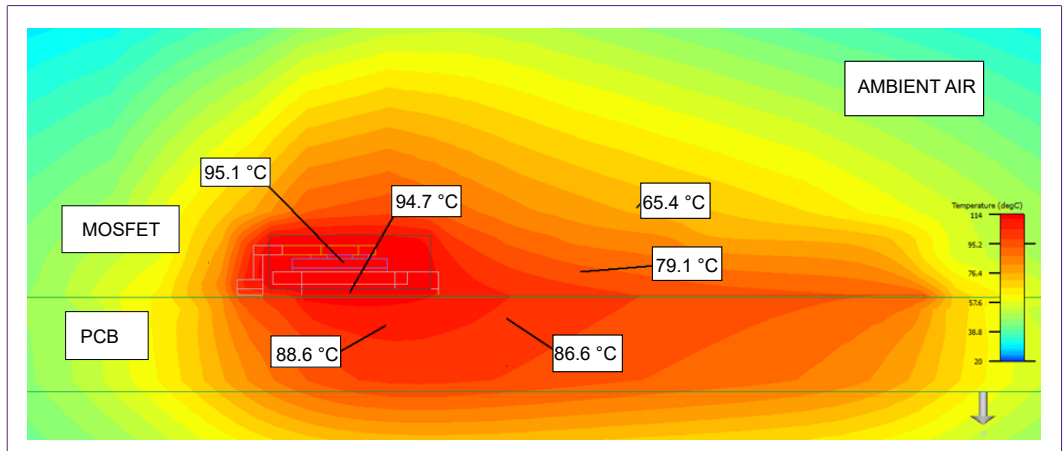

Fig. 43. Thermal result, LFPK33, 0.5 W, 20 °C ambient

Due to the very low thermal resistance between junction and mounting base it is very important to take care of design surrounding the MOSFET, (i.e. thermal vias, copper area, heat sink, water cooling, air cooling), in order to reduce the total thermal resistance.

4. LPAK56 and LPAK88

4.1. Simple configuration with a single layer

In this section, we will present the maximum power dissipation results for a simple PCB configuration using a single layer with varying copper area.

Results are given for the LPAK56 and LPAK88 packages. Models used are based on 1 mΩ LPAK56E and LPAK88.

4.1.1. Set-up:

- 1 copper layer on the top
- MOSFET power dissipation is 1 W, 1.5 W and 2 W
- Maximum junction temperature of 175 °C
- PCB material is standard FR4, 1.6 mm thickness, dimension 100 x 100 mm
- PCB operating temperature of 120 °C and T_j of 175 °C are highlighted in graphs
- Copper thickness is 2 oz./ft² (70 μm)
- The PCB is suspended in free air at ambient temperature of 20 °C
- The simulation is carried out for conduction, convection and radiation heat transfer
- There is no forced air cooling applied, i.e. only natural convection is modeled

The simplest possible PCB stack-up is that of a single top copper layer, see [Fig. 44](#).

In this analysis, we will examine the variation in device junction temperature (T_j) as a function of the top copper area and calculate the maximum power that can be safely dissipated in the MOSFET to reach a T_j of 175 °C.

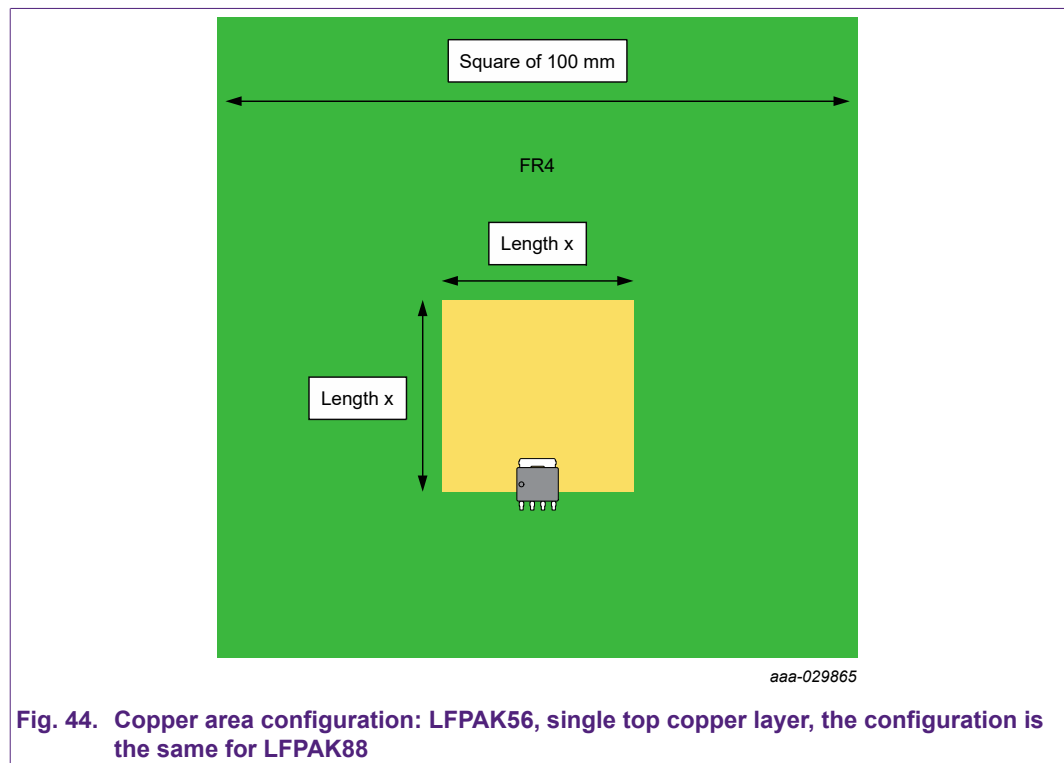



Fig. 44. Copper area configuration: LPAK56, single top copper layer, the configuration is the same for LPAK88

4.1.2. Junction temperature as a function of copper area

The graphs in Fig. 45 and Fig. 46 capture two important factors:

- T_j depends greatly on length “x” and thus copper area, the bigger the area the better the thermal performance
- However, the ability of the top copper to provide heatsinking for the MOSFET shows a “law of diminishing returns”. In other words, we cannot keep on adding more copper area in the hope of continuing to reduce T_j . As can be seen from Fig. 45 below, for LFLPAK56, 1 W profile, T_j will plateau at around 55 °C.

 **Note:** Standard FR4 PCBs operate at a maximum temperature of 120 °C, care must be taken for $T_j > 120$ °C as the PCB area directly under the transistor will be close to the MOSFET junction temperature, (due to low $R_{th(j-mb)}$).

The graphs below also shows the absolute minimum copper area needed for $T_j \leq 175$ °C.

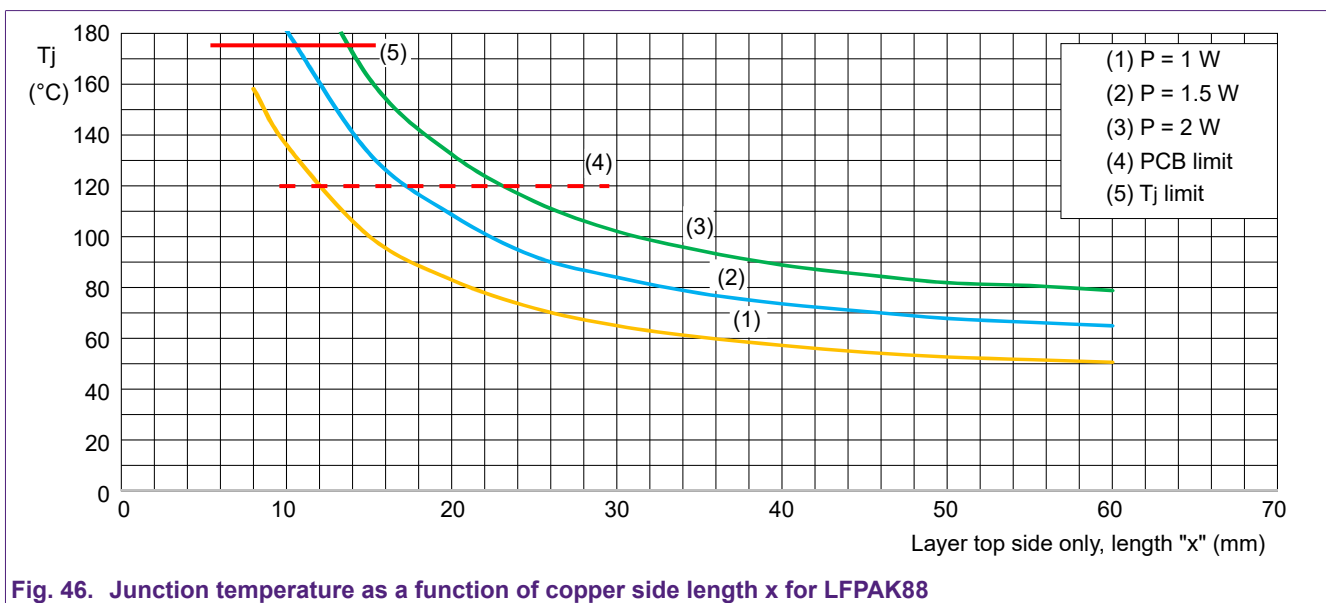
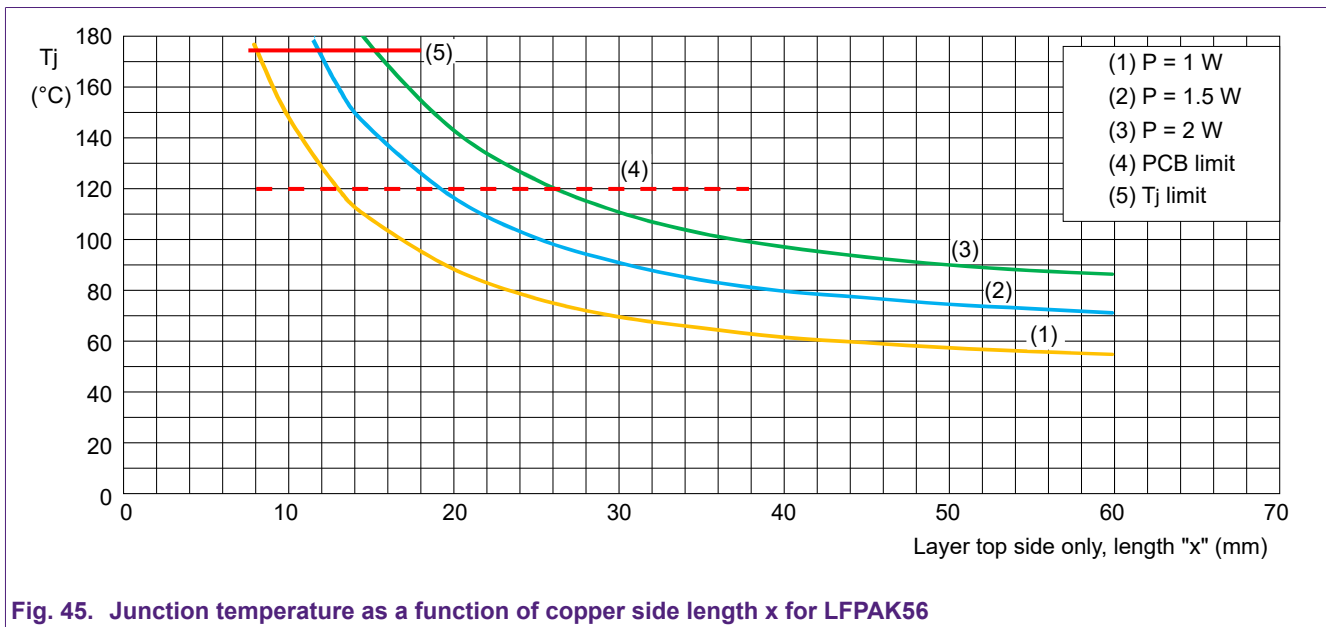

4.1.3. Maximum allowed power dissipation as a function of copper area

The maximum allowed power dissipation is shown in Fig. 47 and Fig. 48 below, for different ambient temperature and copper side length. In this example the PCB temperature was not considered so care must be taken for the resulting heat on the PCB.

From graphs in Fig. 47 and Fig. 48 the maximum permissible power, ($T_{amb} = 20\text{ }^{\circ}\text{C}$), is 5.05 W and 5.9 W for the LFLPAK56 and LFLPAK88 packages respectively:

Table 9. Maximum power dissipation

Device	$T_{amb} = 20\text{ }^{\circ}\text{C}$	$T_{amb} = 80\text{ }^{\circ}\text{C}$
LFLPAK56	5.05 W	3.2 W
LFLPAK88	5.9 W	3.8 W

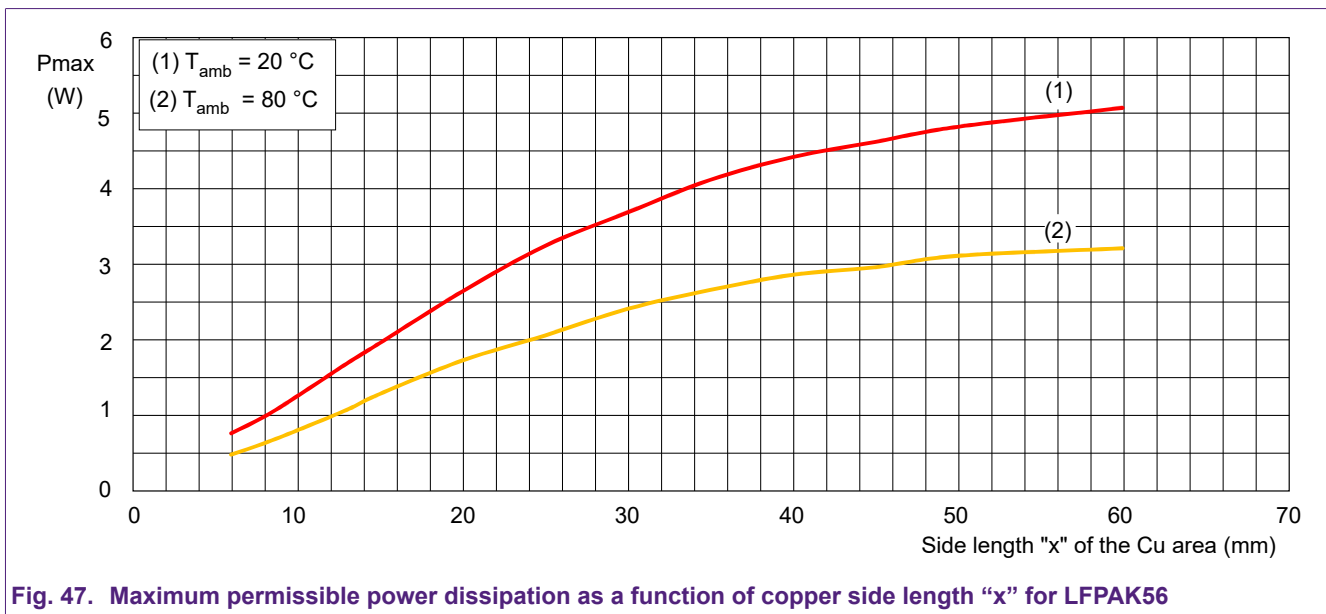

Fig. 47. Maximum permissible power dissipation as a function of copper side length “x” for LFLPAK56

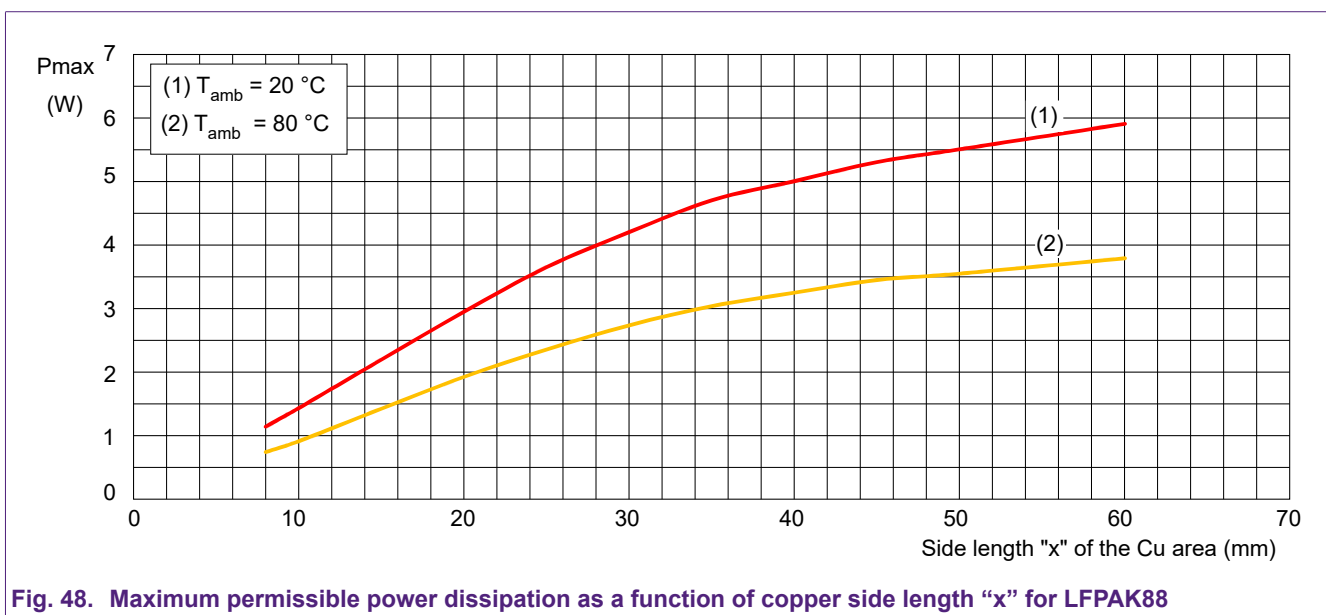

Fig. 48. Maximum permissible power dissipation as a function of copper side length “x” for LFLPAK88

4.2. Usual configuration: 4 layers + vias

In this section, we will present the maximum power dissipation results for a PCB configuration using 4 layers + vias for dissipation on the bottom layer, with varying copper area.

Results are given for the LFPAK56 and LFPAK88 packages.

4.2.1. Set-up:

- Four layers with vias (max number of vias is 25 and for small copper areas this number will decrease accordingly, see [Table 10](#))
- MOSFET power dissipation is 1 W, 1.5 W and 2 W
- Maximum junction temperature of 175 °C
- PCB material is standard FR4, 1.6 mm thickness, dimension 100 x 100 mm
- PCB operating temperature of 120 °C and T_j of 175 °C are highlighted in graphs
- Copper thickness of all layers is 2 oz./ft² (70 μm)
- The PCB is suspended in free air at ambient temperature of 20 °C
- The simulation is carried out for conduction, convection and radiation heat transfer
- There is no forced air cooling applied, i.e. only natural convection is modeled

The common PCB stack-up is 4 layers with vias under the MOSFET to create a dissipation path to heatsink (no heat sink was used in simulation).

In this analysis, we will examine the variation in device junction temperature (T_j) as a function of copper area (same area size applied to all layers).

The configuration of the vias is shown below in [Fig. 49](#) and [Fig. 50](#):

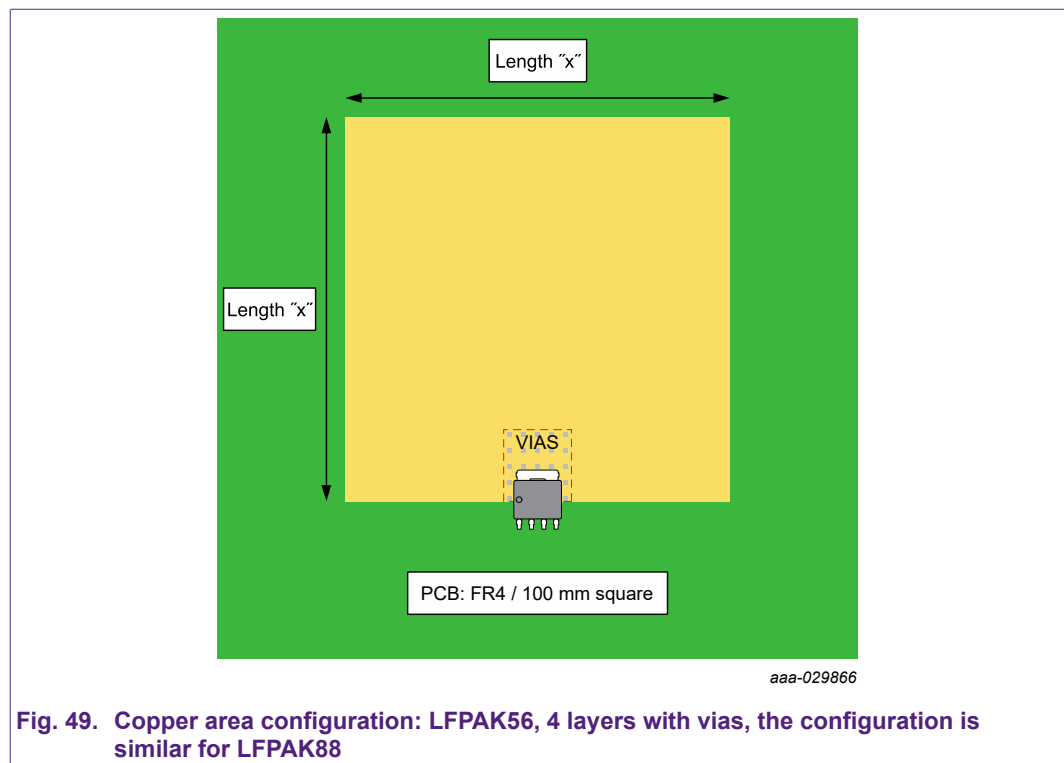

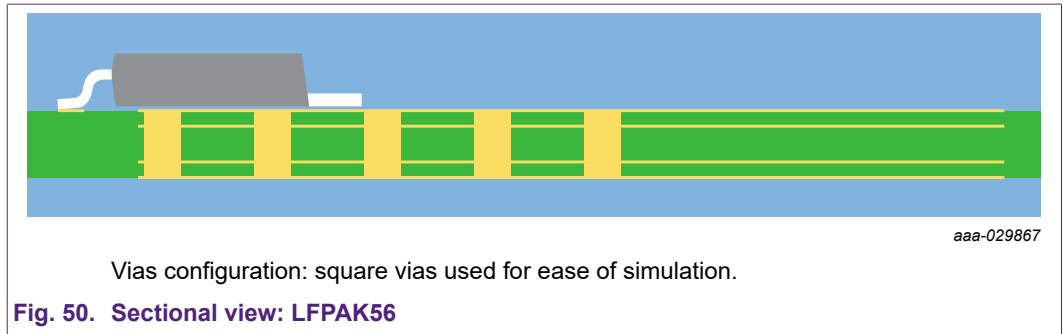

Fig. 50. Sectional view: LFPACK56

Table 10. Limitation of number of vias

X (mm)	Vias configuration	Comments	Vias information
6	9 vias	Maximum number of vias able to be inserted in the copper area	Square vias: length 0.7 mm Vias pitch: 2.5 mm (between vias in columns) 2.0 mm (between vias in rows) Copper thickness 70 µm No solder fill
8			
10	20 vias		
15	25 vias	25 vias maximum	
20	25 vias		
25	25 vias		
30	25 vias		
35	25 vias		
40	25 vias		
45	25 vias		
50	25 vias		
60	25 vias		

4.2.2. Junction temperature as a function of copper area (4 layers and vias)

The graphs in Fig. 51 and Fig. 52 below show the junction temperature as a function of drain copper area following the same trend as the single layer PCB configuration in that:

- T_j depends greatly on copper area
- The ability of the top copper to provide heatsinking for the MOSFET shows a “law of diminishing returns”.

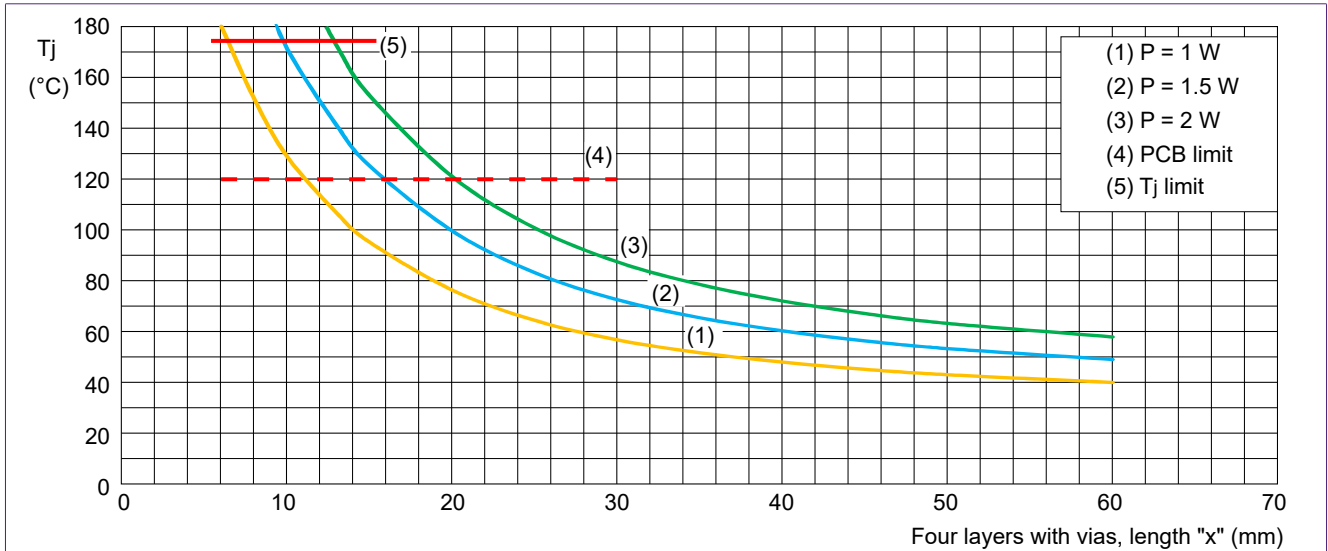

Fig. 51. Junction temperature as a function of copper side length x for LFPAK56

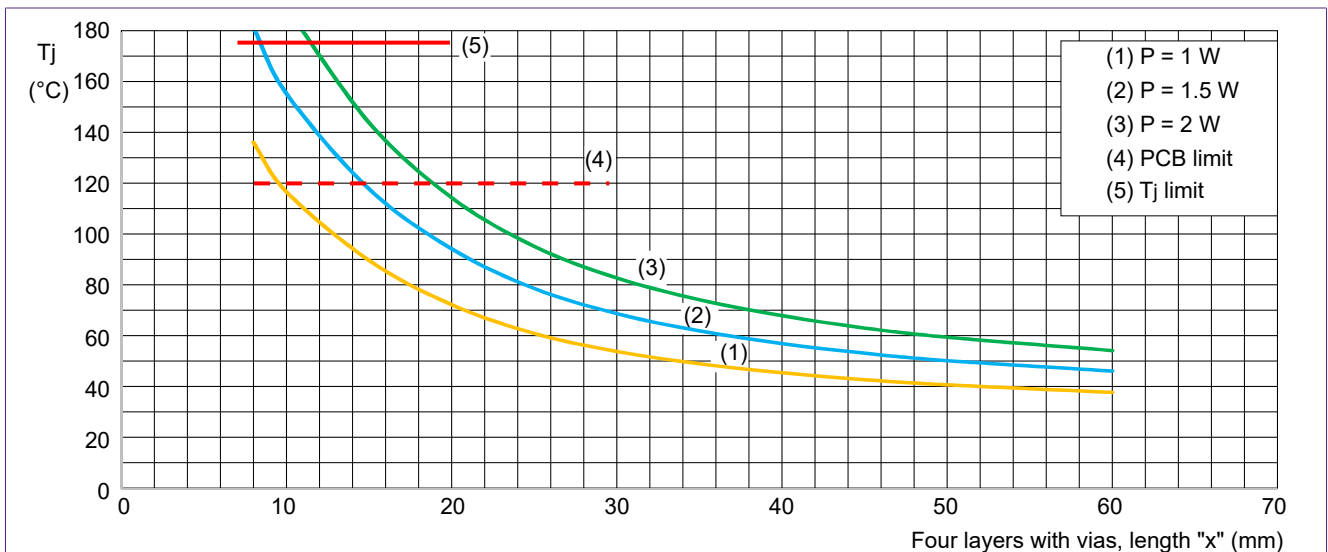

Fig. 52. Junction temperature as a function of copper side length x for LFPAK88

4.2.3. Maximum allowed power dissipation as a function of copper area (4 layers and vias)

From graphs in Fig. 53 and Fig. 54 the maximum power for a given package and conditions are as follows:

Table 11. Maximum power dissipation

Device	T _{amb} = 20 °C	T _{amb} = 80 °C
LFPAK56	9.6 W	6.3 W
LFPAK88	10.65 W	6.9 W

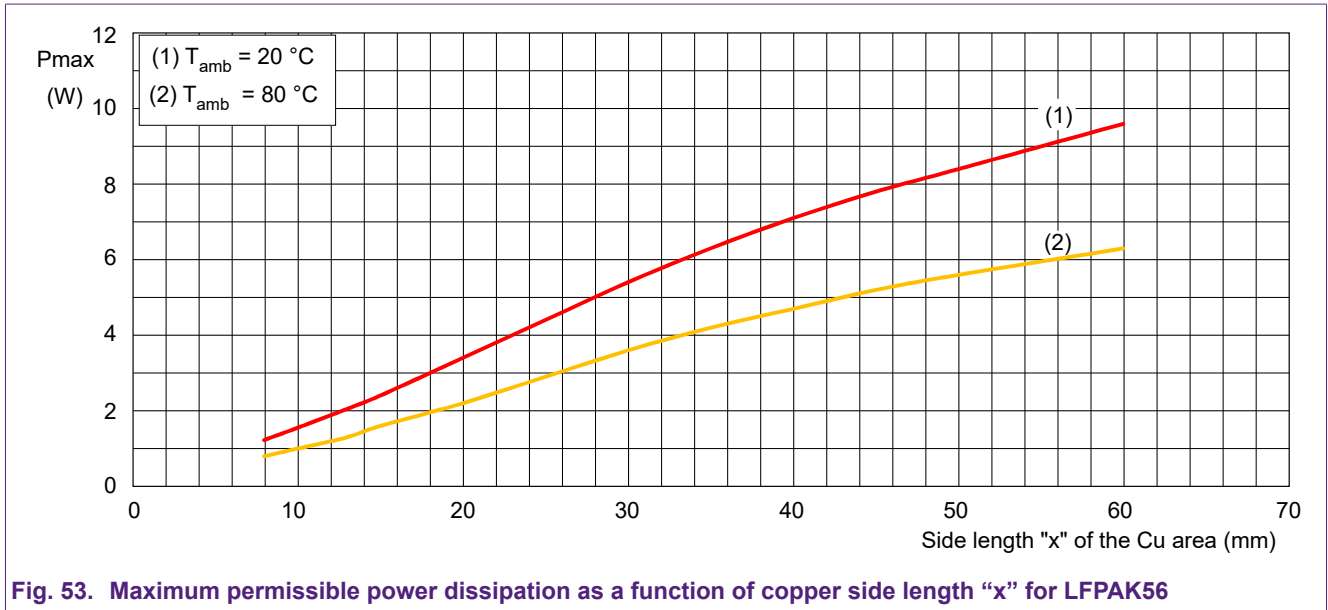

Fig. 53. Maximum permissible power dissipation as a function of copper side length “x” for LFPAK56

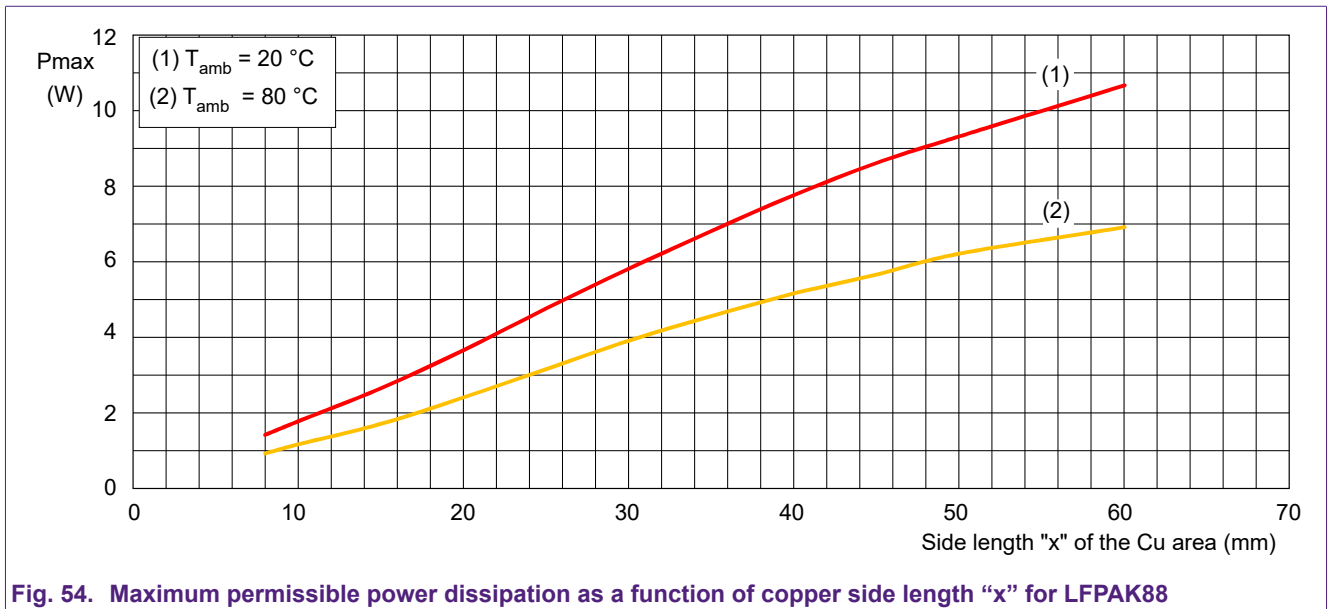

Fig. 54. Maximum permissible power dissipation as a function of copper side length “x” for LFPAK88

4.3. Simple configuration with a single split layer of copper

In this section, we will present the maximum power dissipation results as per the previous section for a simple PCB configuration using a single layer and varying copper area, but with copper layer split in two part (one part placed under the drain tab of the MOSFET and the other under the source pins).

Results are given for the LPAK88 package only.

4.3.1. Set-up:

- 1 copper layer on the top - split into two areas:
 - 3/5 of area under drain tab
 - 2/5 of area under source pins
- MOSFET power dissipation is 1 W, 1.5 W and 2 W
- Maximum junction temperature of 175 °C
- PCB material is standard FR4, 1.6 mm thickness, dimension 100 x 100 mm
- PCB operating temperature of 120 °C and T_j of 175 °C are highlighted in graphs
- Copper thickness is 2 oz./ft² (70 μm)
- The PCB is suspended in free air at ambient temperature of 20 °C
- The simulation is carried out for conduction, convection and radiation heat transfer
- There is no forced air cooling applied, i.e. only natural convection is modeled

The simplest possible PCB stack-up is that of a single top copper layer, see [Fig. 55](#).

In this analysis, we will examine the variation in device junction temperature (T_j) as a function of the top copper area.

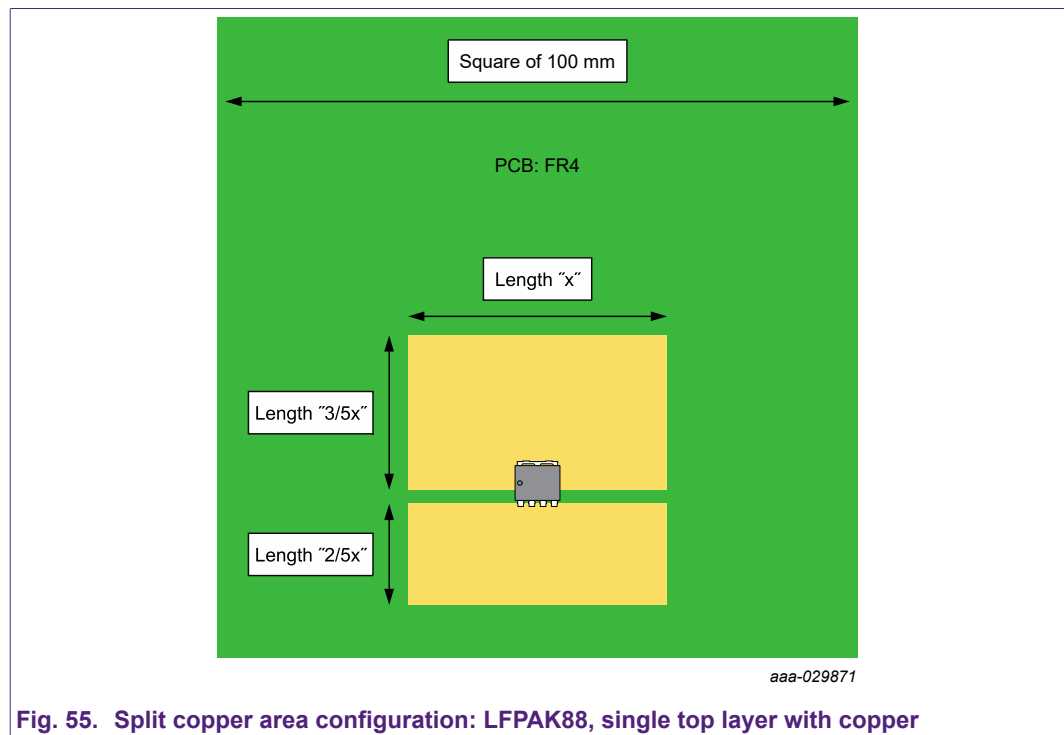



Fig. 55. Split copper area configuration: LPAK88, single top layer with copper

The graph in [Fig. 56](#) captures what has been previously mentioned in terms of copper area and heat dissipation i.e. the bigger the area the better the thermal performance. More importantly in this configuration, it shows the importance in considering the source pins of an LPAK MOSFET as a thermal path for efficiently dissipating heat.

The graph in [Fig. 56](#) also shows that copper area of length $x = 40$ mm in split copper configuration provides a performance equivalent of that provided in the solid (non-split) copper area of length $x = 60$ mm.

Split copper configuration for length “x” = 40 mm is as follows:

- 24 mm x 40 mm copper area placed under the drain tab of the LFPAK MOSFET
- 16 mm x 40 mm copper area placed under the source pins of the LFPAK MOSFET

 **Note:** Standard FR4 PCBs operate at maximum temperature of 120 °C, care must be taken for $T_j > 120$ °C as PCB area directly under the transistor would be close to the MOSFET junction temperature (due to low $R_{th(j-mb)}$).

Results are for LFPAK88, but the principle applies to all Nexperia clip bond LFPAK devices. $T_{amb} = 20$ °C: Max power of ~6 W is achieved with an area of 40 mm x 40 mm single copper layer in split configuration, whilst previously shown to require an area of 60 mm x 60 mm for single solid copper layer.

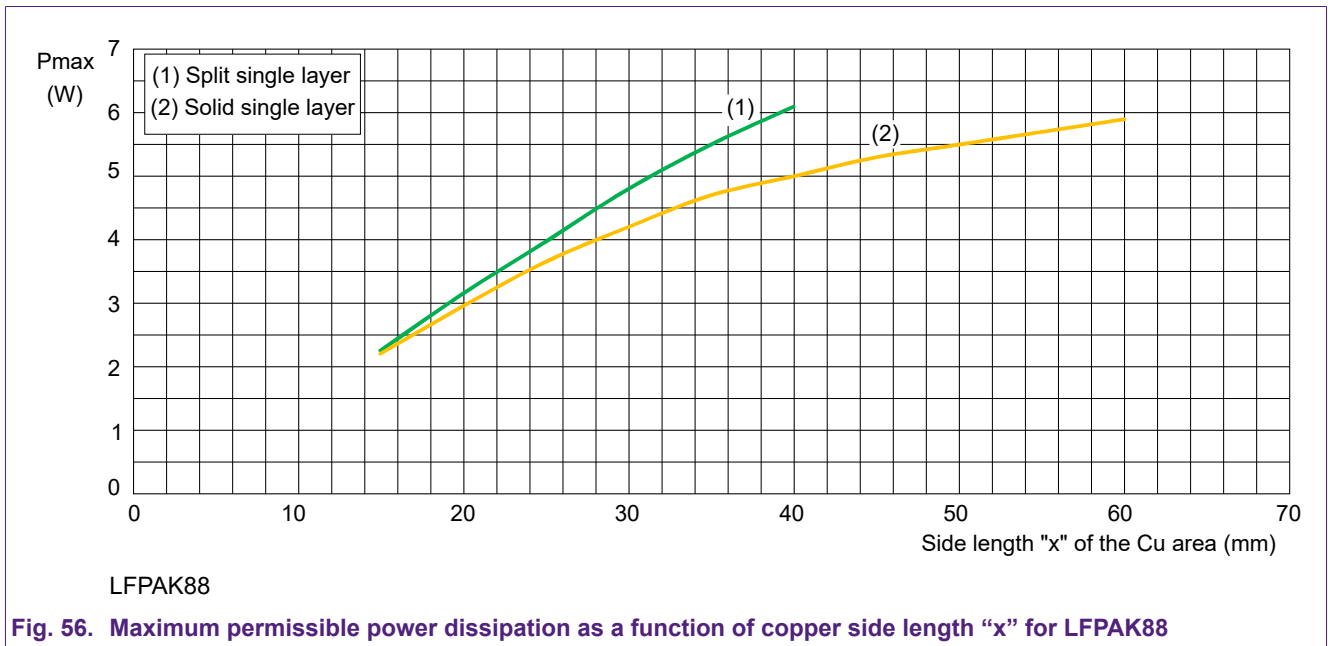

4.4. Impact of $R_{th(j-mb)}$ compared to $R_{th(mb-amb)}$

The thermal resistance $R_{th(j-mb)}$ of the MOSFET is very low and therefore dissipation losses are mainly limited by the high thermal resistive path presented by $R_{th(mb-amb)}$ (mounting base to ambient).

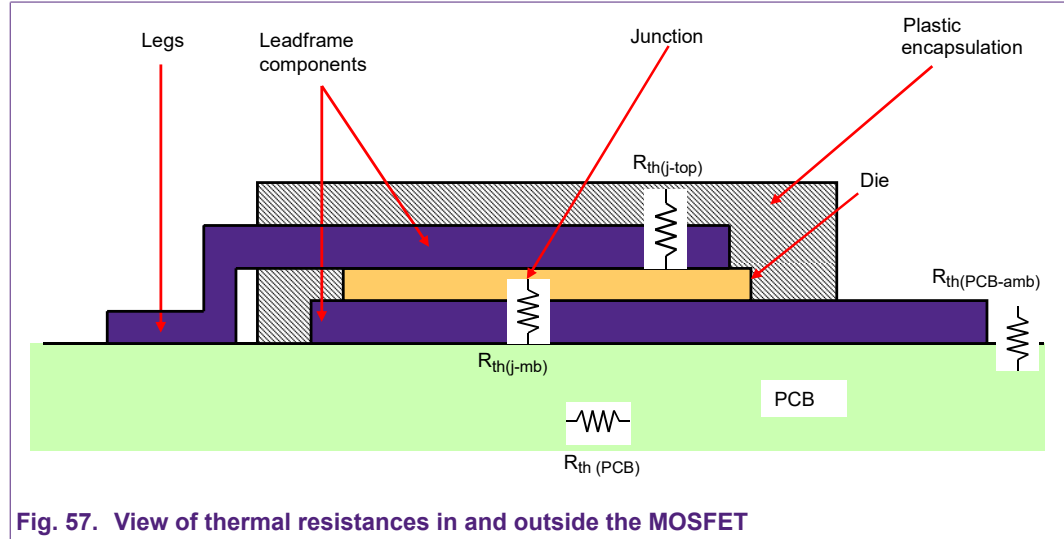

Fig. 57. View of thermal resistances in and outside the MOSFET

Example: for the part number BUK7S1R0-40H (LFLPAK88, 1 mΩ, 40 V) the maximum thermal resistance junction to mounting base is 0.4 K/W, see [Table 12](#):

Table 12. Thermal resistance BUK7S1R0-40H

Symbol	Parameter	Conditions	Min	Typ	Max	Unit
$R_{th(j-mb)}$	thermal resistance from junction to mounting base		-	0.35	0.4	K/W

Using thermal simulation (Flotherm) with the following conditions:

- 1 W of losses in the MOSFET
- Ambient air temperature of 20 °C
- 70 μm copper

we can calculate the thermal resistance for different paths, example:

- 1 W of losses in the MOSFET
- Junction temperature = 52.2 °C
- Mounting base temperature = 52.0 °C
- $R_{\theta} = \Delta T / P \Rightarrow R_{th(j-mb)} = 0.2 \text{ K/W}$.

This is lower than the measured value given in the data sheet due to simulation using ideal conditions.

As can be seen in [Fig. 58](#) below, the thermal resistance between mounting base and ambient is of much higher value (~30 K/W) than $R_{th(j-mb)}$.

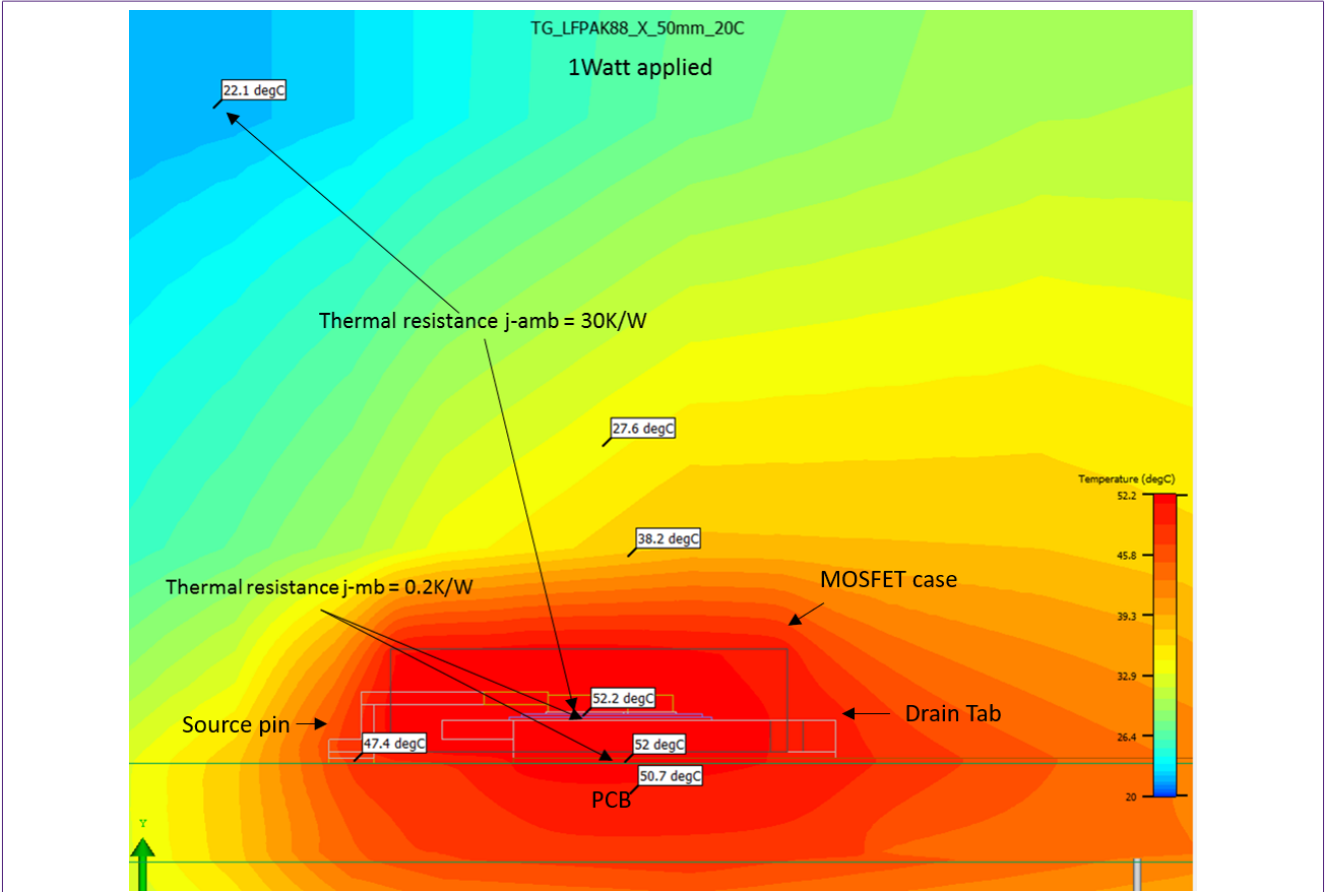

Fig. 58. Thermal resistance LFPK88: single layer copper profile (50 x 50 mm)

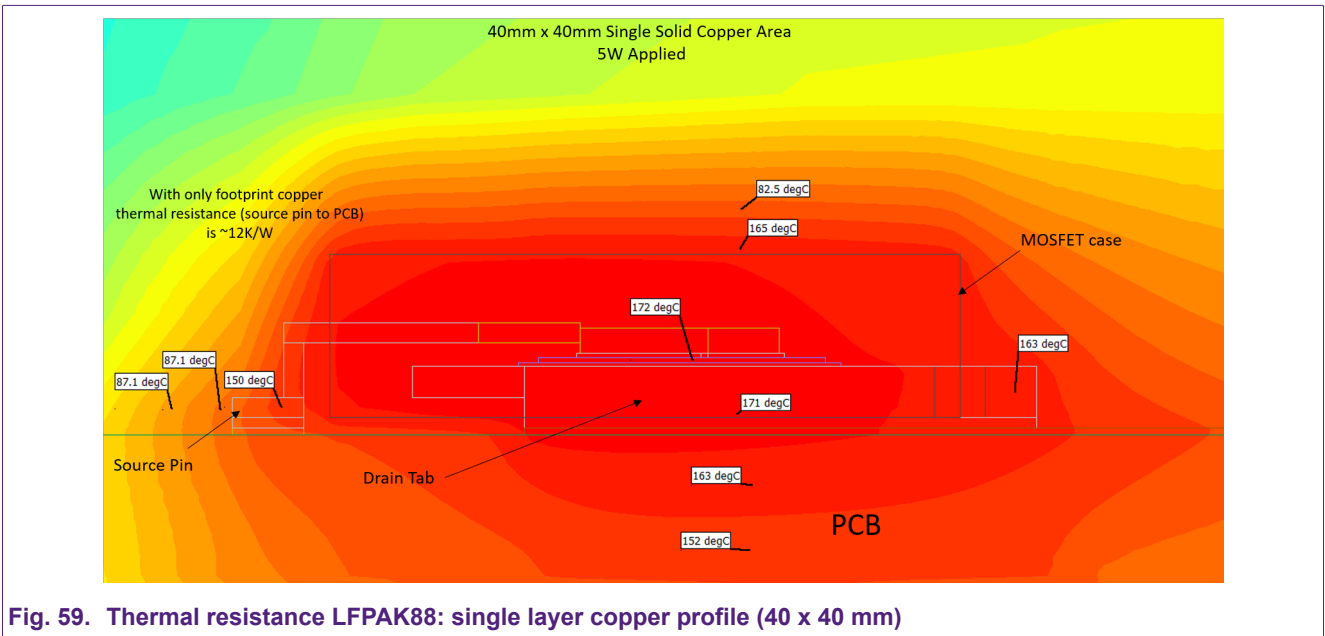

Fig. 59. Thermal resistance LFPK88: single layer copper profile (40 x 40 mm)

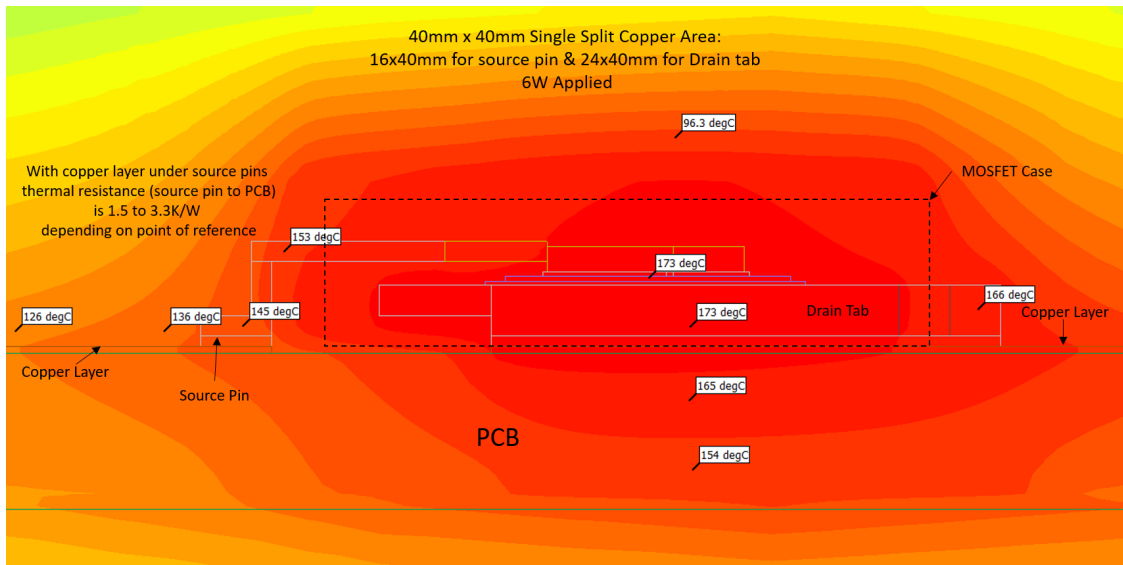

Fig. 60. Thermal resistance LFPK88: single split layer copper profile (40 x 40 mm: split into 24 x 40 mm and 16 x 40 mm)

5. Conclusion

All the LFPACK packages offer a very good junction to mounting base thermal performance, meaning that the mounting base can be near to the junction temperature, but this is often limited by the PCB high temperature capability.

It is very important for designs to reduce the thermal resistance between mounting base and the ambient environment as this will present the bottleneck in heat dissipation. All of Nexperia LFPACK packages use clip bond technology making their source pins a good thermal path in addition to the thermal path provided by the drain tab. To take full advantage of this feature, it is important for PCB layout designs to consider placing a good amount of copper under the source pins. The drain tab still presents the main thermal path for heat dissipation and should be the focus for any thermal design layout.

In all cases a configuration with 4 layers with vias substantially improves the heat dissipation.

This thermal guide establishes the necessary principles in thermal design approaches, combined with LFPACK packages features (i.e. low $R_{th(j-mb)}$ and source clip bond) offer the designer good options in optimizing PCB thermal design.

Good thermal design practices should be applied to take advantage of the very good thermal performance LFPACK packages and $T_{j(max)}$ must be kept $< 175\text{ °C}$ for safe operation.

6. Revision history

Table 13. Revision history

Revision number	Date	Description
3.1	2021-01-22	Equation 9 corrected.
3.0	2020-07-22	Section 2 added.
2.0	2019-05-09	Additional section added for LFPACK56 and LFPACK88. Formatting of graphs updated.
1.0	2019-02-04	Initial version of the document

7. Legal information

Definitions

Draft — The document is a draft version only. The content is still under internal review and subject to formal approval, which may result in modifications or additions. Nexperia does not give any representations or warranties as to the accuracy or completeness of information included herein and shall have no liability for the consequences of use of such information.

Disclaimers

Limited warranty and liability — Information in this document is believed to be accurate and reliable. However, Nexperia does not give any representations or warranties, expressed or implied, as to the accuracy or completeness of such information and shall have no liability for the consequences of use of such information. Nexperia takes no responsibility for the content in this document if provided by an information source outside of Nexperia.

In no event shall Nexperia be liable for any indirect, incidental, punitive, special or consequential damages (including - without limitation - lost profits, lost savings, business interruption, costs related to the removal or replacement of any products or rework charges) whether or not such damages are based on tort (including negligence), warranty, breach of contract or any other legal theory.

Notwithstanding any damages that customer might incur for any reason whatsoever, Nexperia's aggregate and cumulative liability towards customer for the products described herein shall be limited in accordance with the Terms and conditions of commercial sale of Nexperia.

Right to make changes — Nexperia reserves the right to make changes to information published in this document, including without limitation specifications and product descriptions, at any time and without notice. This document supersedes and replaces all information supplied prior to the publication hereof.

Suitability for use — Nexperia products are not designed, authorized or warranted to be suitable for use in life support, life-critical or safety-critical systems or equipment, nor in applications where failure or malfunction of an Nexperia product can reasonably be expected to result in personal injury, death or severe property or environmental damage. Nexperia and its suppliers accept no liability for inclusion and/or use of Nexperia products in such equipment or applications and therefore such inclusion and/or use is at the customer's own risk.

Applications — Applications that are described herein for any of these products are for illustrative purposes only. Nexperia makes no representation or warranty that such applications will be suitable for the specified use without further testing or modification.

Customers are responsible for the design and operation of their applications and products using Nexperia products, and Nexperia accepts no liability for any assistance with applications or customer product design. It is customer's sole responsibility to determine whether the Nexperia product is suitable and fit for the customer's applications and products planned, as well as for the planned application and use of customer's third party customer(s). Customers should provide appropriate design and operating safeguards to minimize the risks associated with their applications and products.

Nexperia does not accept any liability related to any default, damage, costs or problem which is based on any weakness or default in the customer's applications or products, or the application or use by customer's third party customer(s). Customer is responsible for doing all necessary testing for the customer's applications and products using Nexperia products in order to avoid a default of the applications and the products or of the application or use by customer's third party customer(s). Nexperia does not accept any liability in this respect.

Export control — This document as well as the item(s) described herein may be subject to export control regulations. Export might require a prior authorization from competent authorities.

Translations — A non-English (translated) version of a document is for reference only. The English version shall prevail in case of any discrepancy between the translated and English versions.

Trademarks

Notice: All referenced brands, product names, service names and trademarks are the property of their respective owners.

List of Tables

Table 1. Typical thermal conductivity values.....	4
Table 2. Thermal convection coefficient values.....	4
Table 3. Typical emissivity values.....	5
Table 4. Thermal and electrical analogous parameters.....	6
Table 5. Limitation of number of vias.....	20
Table 6. Vias configuration.....	24
Table 7. Thermal resistance BUK7M15-60E.....	33
Table 8. Breakdown of thermal resistance for a simple case.....	33
Table 9. Maximum power dissipation.....	37
Table 10. Limitation of number of vias.....	39
Table 11. Maximum power dissipation.....	41
Table 12. Thermal resistance BUK7S1R0-40H.....	44
Table 13. Revision history.....	47

List of Figures

Fig. 1. Thermal propagation phenomena.....	3	Fig. 33. Copper area configuration: LPAK56D, single top copper layer.....	26
Fig. 2. Conduction in a solid medium.....	3	Fig. 34. Junction temperature as a function of copper side length x for 2 LPAK56D.....	27
Fig. 3. Convection in free air.....	4	Fig. 35. Copper area configuration: LPAK33, single top copper layer.....	28
Fig. 4. Radiation.....	5	Fig. 36. Copper area configuration: 2 x LPAK33, 2 x LPAK56D; separation between MOSFETs.....	29
Fig. 5. SPICE model.....	6	Fig. 37. Junction temperature as a function of copper side length x for 2 LPAK33.....	29
Fig. 6. Response.....	6	Fig. 38. Copper area configuration: 1 x LPAK56D, 2 x LPAK56, single top copper layer.....	30
Fig. 7. Thermal and electrical resistance models.....	7	Fig. 39. Junction temperature as a function of copper side length x for 2 LPAK56 and 1 LPAK56D.....	31
Fig. 8. Thermal and electrical capacitance models.....	7	Fig. 40. Copper area configuration: 1 x LPAK56D, 2 x LPAK33, single top copper layer.....	32
Fig. 9. Transient and steady state thermal behavior.....	8	Fig. 41. Junction temperature as a function of copper side length x for 1 LPAK56D and 2 LPAK33.....	32
Fig. 10. Thermal path junction to mounting base.....	8	Fig. 42. View of thermal resistances in and outside the MOSFET.....	33
Fig. 11. Thermal path junction to ambient.....	9	Fig. 43. Thermal result, LPAK33, 0.5 W, 20 °C ambient..	34
Fig. 12. Simplified $R_{th}(j-a)$ thermal paths.....	9	Fig. 44. Copper area configuration: LPAK56, single top copper layer, the configuration is the same for LPAK88.....	35
Fig. 13. Thermal circuit, MOSFET, PCB and environment.	10	Fig. 45. Junction temperature as a function of copper side length x for LPAK56.....	36
Fig. 14. Copper area configuration: LPAK56D, single top copper layer.....	12	Fig. 46. Junction temperature as a function of copper side length x for LPAK88.....	36
Fig. 15. Junction temperature as a function of copper side length x for LPAK56D.....	13	Fig. 47. Maximum permissible power dissipation as a function of copper side length “ x ” for LPAK56.....	37
Fig. 16. Maximum permissible power dissipation as a function of copper side length x for LPAK56D.....	14	Fig. 48. Maximum permissible power dissipation as a function of copper side length “ x ” for LPAK88.....	37
Fig. 17. Junction temperature as a function of copper side length x for LPAK56D; one MOSFET conducting.....	15	Fig. 49. Copper area configuration: LPAK56, 4 layers with vias, the configuration is similar for LPAK88.....	38
Fig. 18. Maximum power as a function of side length x for LPAK56D; one MOSFET conducting.....	15	Fig. 50. Sectional view: LPAK56.....	39
Fig. 19. Thermal resistance configuration.....	16	Fig. 51. Junction temperature as a function of copper side length x for LPAK56.....	40
Fig. 20. Copper area configuration: LPAK33, single top copper layer.....	17	Fig. 52. Junction temperature as a function of copper side length x for LPAK88.....	40
Fig. 21. Junction temperature as a function of copper side length x for LPAK33.....	17	Fig. 53. Maximum permissible power dissipation as a function of copper side length “ x ” for LPAK56.....	41
Fig. 22. Maximum permissible power dissipation as a function of copper side length x for LPAK33.....	18	Fig. 54. Maximum permissible power dissipation as a function of copper side length “ x ” for LPAK88.....	41
Fig. 23. Copper area configuration: LPAK56D, 4 layers with vias.....	19	Fig. 55. Split copper area configuration: LPAK88, single top layer with copper.....	42
Fig. 24. Sectional view: LPAK56D.....	20	Fig. 56. Maximum permissible power dissipation as a function of copper side length “ x ” for LPAK88.....	43
Fig. 25. Junction temperature as a function of copper side length x for LPAK56D.....	20	Fig. 57. View of thermal resistances in and outside the MOSFET.....	44
Fig. 26. Maximum permissible power dissipation as a function of copper side length x for LPAK56D.....	21	Fig. 58. Thermal resistance LPAK88: single layer copper profile (50 x 50 mm).....	45
Fig. 27. Junction temperature as a function of copper side length x for LPAK56D; one MOSFET.....	22	Fig. 59. Thermal resistance LPAK88: single layer copper profile (40 x 40 mm).....	45
Fig. 28. Power dissipation as a function of copper side length x for LPAK56D; one MOSFET.....	22		
Fig. 29. copper area configuration: LPAK33, 4 layers with vias.....	23		
Fig. 30. Sectional view: LPAK33.....	24		
Fig. 31. Junction temperature as a function of copper side length x for LPAK33.....	25		
Fig. 32. Maximum permissible power dissipation as a function of copper side length x for LPAK33.....	25		

Fig. 60. Thermal resistance LFPAK88: single split layer copper profile (40 x 40 mm: split into 24 x 40 mm and 16 x 40 mm)..... 46

Contents

1. Introduction	2
2. MOSFET power dissipation and the design environment	2
2.1. Heat propagation phenomena.....	3
2.1.1. Conduction.....	3
2.1.2. Convection.....	4
2.1.3. Radiation.....	5
2.2. Thermal – Electrical analogy.....	6
2.2.1. Thermal resistance.....	7
2.2.2. Thermal capacitance.....	7
2.2.3. Transient and steady state thermal behavior.....	8
2.3. MOSFET steady state thermal characteristics.....	8
2.3.1. Thermal resistance junction to mounting base - $R_{th(j-mb)}$	8
2.3.2. Thermal resistance junction to ambient - $R_{th(j-a)}$	9
2.3.3. PCB thermal limitation and the 1 Watt rule.....	10
2.3.4. Thermal nomenclature.....	11
3. LFPACK56D and LFPACK33	12
3.1. Simple configuration with a single layer.....	12
3.1.1. LFPACK56D.....	12
3.1.2. LFPACK56D only one MOSFET active at a time.....	15
3.1.3. LFPACK33.....	16
3.2. Usual configuration: 4 layers + vias.....	19
3.2.1. LFPACK56D.....	19
3.2.2. LFPACK56D only one MOSFET active at a time.....	22
3.2.3. LFPACK33.....	23
3.3. Placement advice for improved dissipation.....	26
3.3.1. LFPACK56D.....	26
3.3.2. LFPACK33.....	27
3.4. Comparison between two LFPACK56 and one LFPACK56D, then one LFPACK56D and two LFPACK33.....	30
3.4.1. Two LFPACK56 to LFPACK56D.....	30
3.4.2. LFPACK56D to two LFPACK33	31
3.5. Impact of $R_{th(j-mb)}$ compared to $R_{th(mb-a)}$	33
4. LFPACK56 and LFPACK88	35
4.1. Simple configuration with a single layer.....	35
4.1.1. Set-up:.....	35
4.1.2. Junction temperature as a function of copper area.....	36
4.1.3. Maximum allowed power dissipation as a function of copper area.....	37
4.2. Usual configuration: 4 layers + vias.....	38
4.2.1. Set-up:.....	38
4.2.2. Junction temperature as a function of copper area (4 layers and vias).....	40
4.2.3. Maximum allowed power dissipation as a function of copper area (4 layers and vias).....	41
4.3. Simple configuration with a single split layer of copper.....	42
4.3.1. Set-up:.....	42
4.4. Impact of $R_{th(j-mb)}$ compared to $R_{th(mb-amb)}$	44
5. Conclusion	47
6. Revision history	47
7. Legal information	48

© Nexperia B.V. 2021. All rights reserved

For more information, please visit: <http://www.nexperia.com>
 For sales office addresses, please send an email to: salesaddresses@nexperia.com
 Date of release: 22 January 2021