

Important notice

Dear Customer,

On 7 February 2017 the former NXP Standard Product business became a new company with the tradename **Nexperia**. Nexperia is an industry leading supplier of Discrete, Logic and PowerMOS semiconductors with its focus on the automotive, industrial, computing, consumer and wearable application markets

In data sheets and application notes which still contain NXP or Philips Semiconductors references, use the references to Nexperia, as shown below.

Instead of <http://www.nxp.com>, <http://www.philips.com/> or <http://www.semiconductors.philips.com/>, use <http://www.nexperia.com>

Instead of sales.addresses@www.nxp.com or sales.addresses@www.semiconductors.philips.com, use salesaddresses@nexperia.com (email)

Replace the copyright notice at the bottom of each page or elsewhere in the document, depending on the version, as shown below:

- © NXP N.V. (year). All rights reserved or © Koninklijke Philips Electronics N.V. (year). All rights reserved

Should be replaced with:

- © **Nexperia B.V. (year). All rights reserved.**

If you have any questions related to the data sheet, please contact our nearest sales office via e-mail or telephone (details via salesaddresses@nexperia.com). Thank you for your cooperation and understanding,

Kind regards,

Team Nexperia



SOD963

DSN1608-2; Leadless very small package; Reel pack, SMD, 7"
Q1/T1 standard product orientation
Orderable part number ending ,315 or YL
Ordering code (12NC) ending 315

Rev. 1 — 26 July 2016

Packing information

1. Packing method

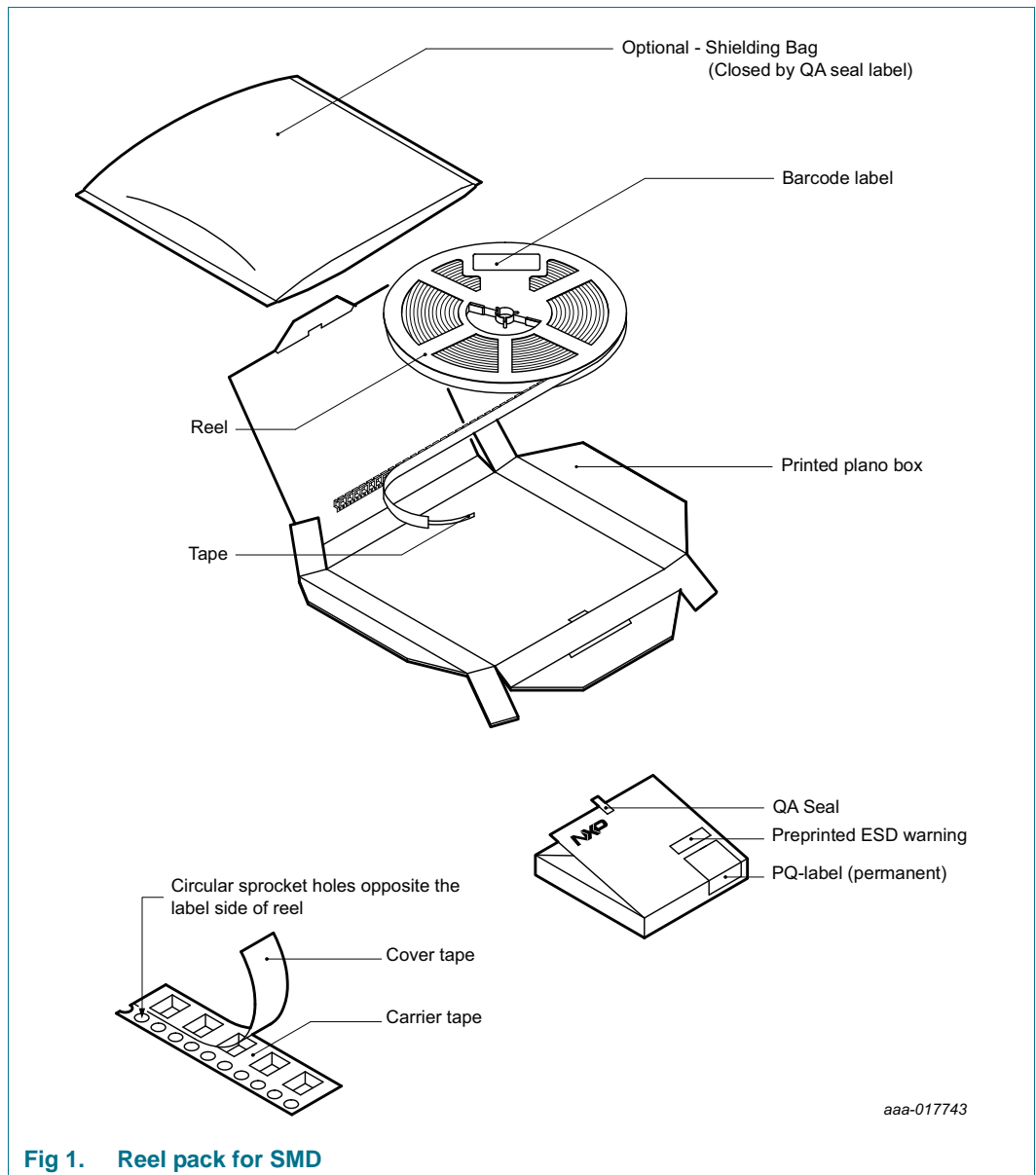

DSN1608-2; Leadless very small package; Reel pack, SMD, 7" Q1/T1 standard product orientation
 Orderable part number ending ,315 or YL
 Ordering code (12NC) ending 315

Table 1. Dimensions and quantities

Reel dimensions d × w (mm) [1]	SPQ/PQ (pcs) [2]	Reels per box	Outer box dimensions l × w × h (mm)
180 × 8	10000	1	187 × 187 × 18

[1] d = reel diameter; w = tape width.

[2] Packing quantity dependent on specific product type.

View ordering and availability details at [NXP order portal](#), or contact your local NXP representative.

2. Product orientation

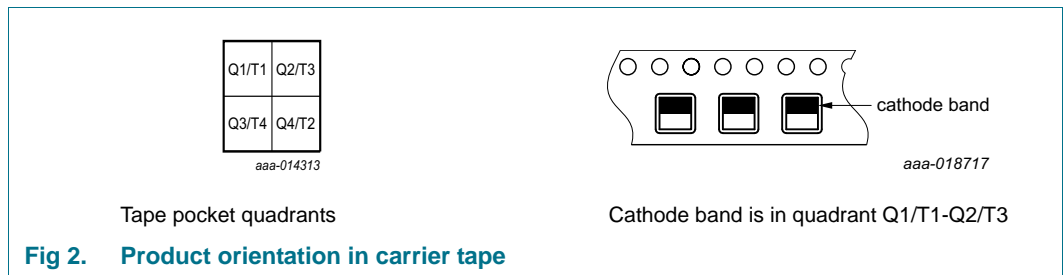

3. Carrier tape dimensions

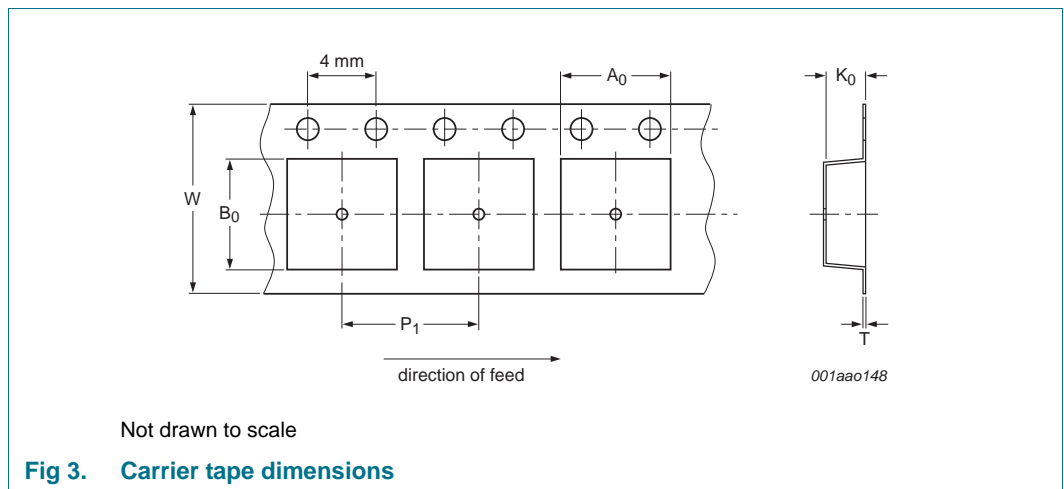

Table 2. Carrier tape dimensions

In accordance with IEC 60286-3.

A ₀ (mm)	B ₀ (mm)	K ₀ (mm)	T (mm)	P ₁ (mm)	W (mm)
0.88 ± 0.03	1.68 ± 0.03	0.36 ± 0.03	0.20 ± 0.02	2.00 ± 0.1	8 ± 0.1

4. Reel dimensions

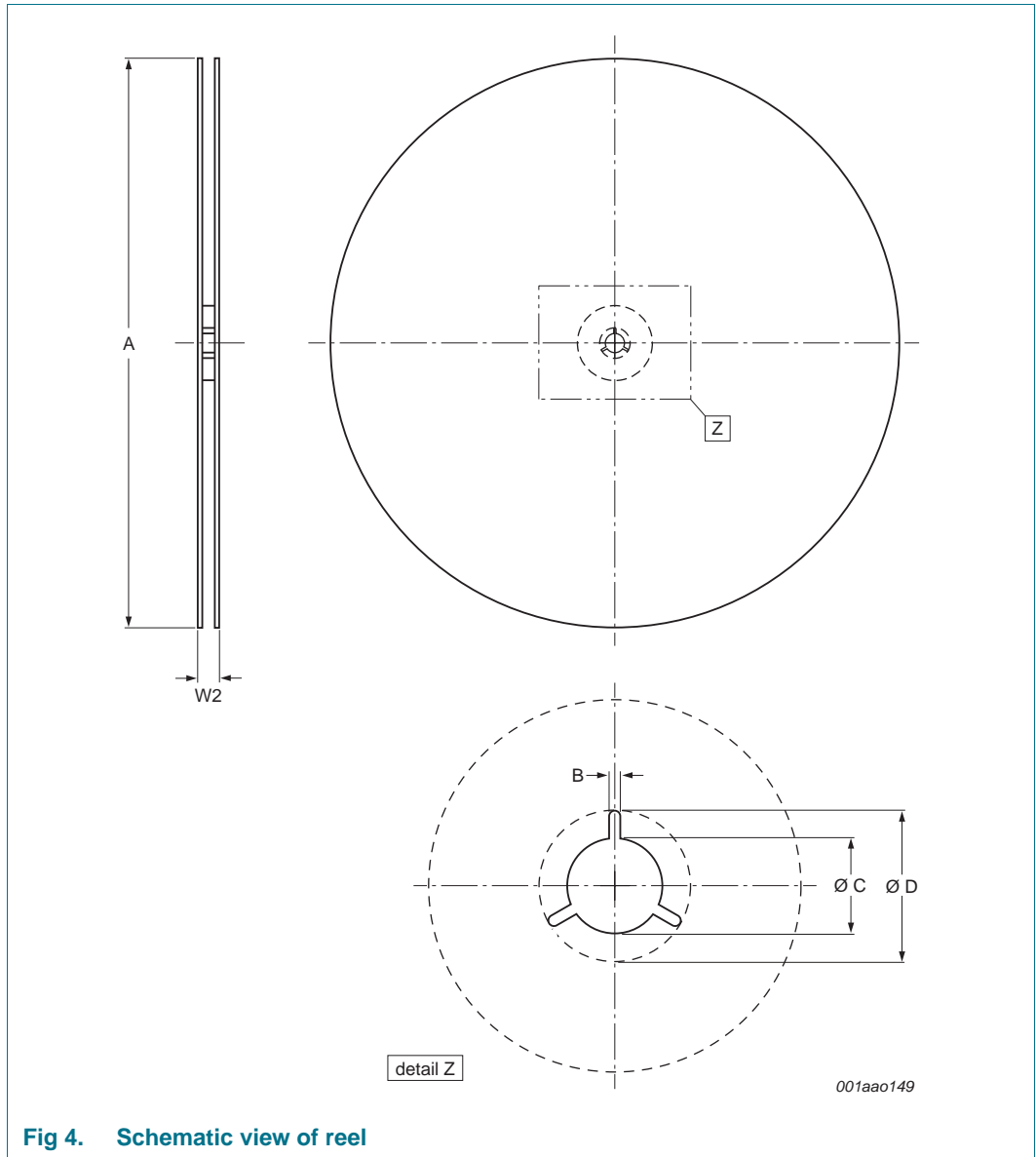

Fig 4. Schematic view of reel

Table 3. Reel dimensions
 In accordance with IEC 60286-3.

A [nom] (mm)	W2 [max] (mm)	B [min] (mm)	C [min] (mm)	D [min] (mm)
180	14.4	1.5	12.8	20.2

DSN1608-2; Leadless very small package; Reel pack, SMD, 7"
 Q1/T1 standard product orientation
 Orderable part number ending ,315 or YL
 Ordering code (12NC) ending 315

5. Barcode label

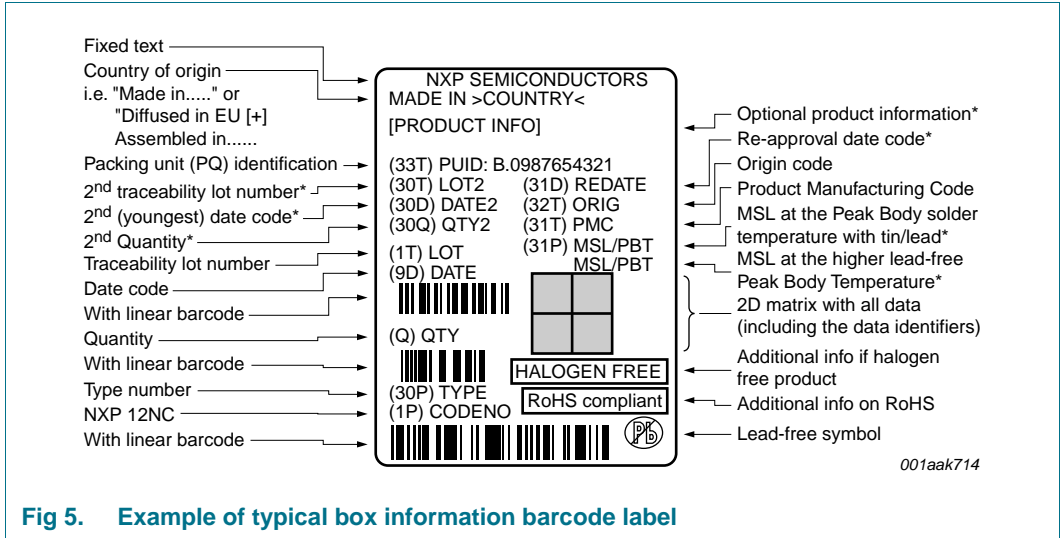

Fig 5. Example of typical box information barcode label



Fig 6. Example of typical reel information barcode label

Table 4. Barcode label dimensions

Box barcode label l x w (mm)	Reel barcode label l x w (mm)
100 x 75	36 x 75

DSN1608-2; Leadless very small package; Reel pack, SMD, 7"
Q1/T1 standard product orientation
Orderable part number ending ,315 or YL
Ordering code (12NC) ending 315

6. Revision history

Table 5. Revision history

Document ID	Release date	Packing document status	Change notice	Supersedes
SOD963_315 v.1.1	20160726	Packing information	-	-

Limited warranty and liability

Information in this document is believed to be accurate and reliable. However, NXP Semiconductors does not give any representations or warranties, expressed or implied, as to the accuracy or completeness of such information and shall have no liability for the consequences of use of such information.

© NXP Semiconductors N.V. 2016.

For more information, please visit: <http://www.nxp.com>
For sales office addresses, please send an email to: salesaddresses@nxp.com

All rights reserved.

Date of release: 26 July 2016
Document identifier: SOD963_315