

SPICE thermal model

BUK7M6R0-40H

Symbol	Parameter	Conditions	Min	Typ	Max	Unit
$R_{th(j-mb)}$	thermal resistance from junction to mounting base		-	-	2.14	K/W

C_{th1}	2.723E-06 F
C_{th2}	7.220E-05 F
C_{th3}	5.557E-04 F
C_{th4}	1.815E-03 F
C_{th5}	2.189E-02 F

R_{th1}	2.746E-03 Ω
R_{th2}	4.601E-02 Ω
R_{th3}	2.991E-01 Ω
R_{th4}	1.230E+00 Ω
R_{th5}	5.564E-01 Ω

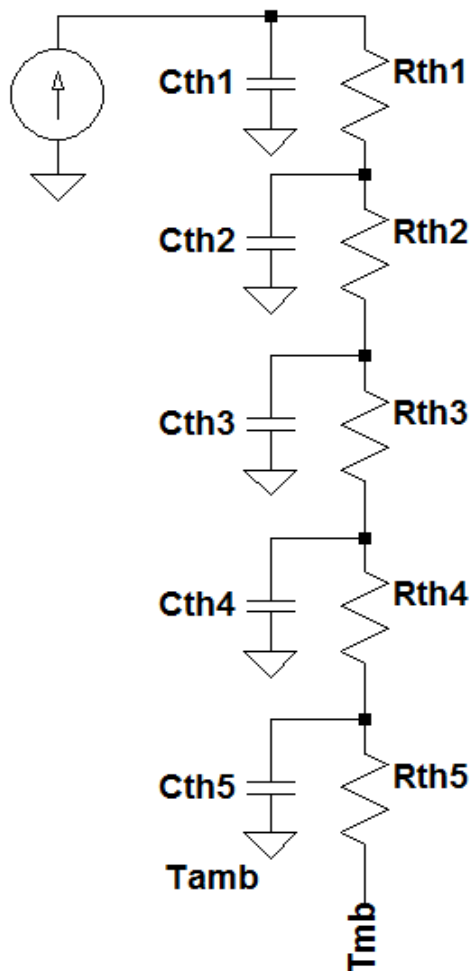

Part: BUK7M6R0-40H

Date: 24/1/2019

Model Rth 2.13 K/W