

SPICE thermal model

BUK7Y1R7-40H

Symbol	Parameter	Conditions	Min	Typ	Max	Unit
$R_{th(j-mb)}$	thermal resistance from junction to mounting base		-	-	0.51	K/W

C_{th1}	6.145E-04 F
C_{th2}	1.366E-03 F
C_{th3}	1.548E-03 F
C_{th4}	3.028E-03 F
C_{th5}	7.562E-03 F
C_{th6}	9.367E-03 F
C_{th7}	4.833E+00 F
R_{th1}	1.855E-04 Ω
R_{th2}	9.306E-04 Ω
R_{th3}	7.703E-03 Ω
R_{th4}	3.891E-02 Ω
R_{th5}	1.512E-01 Ω
R_{th6}	3.062E-01 Ω
R_{th7}	4.910E-03 Ω

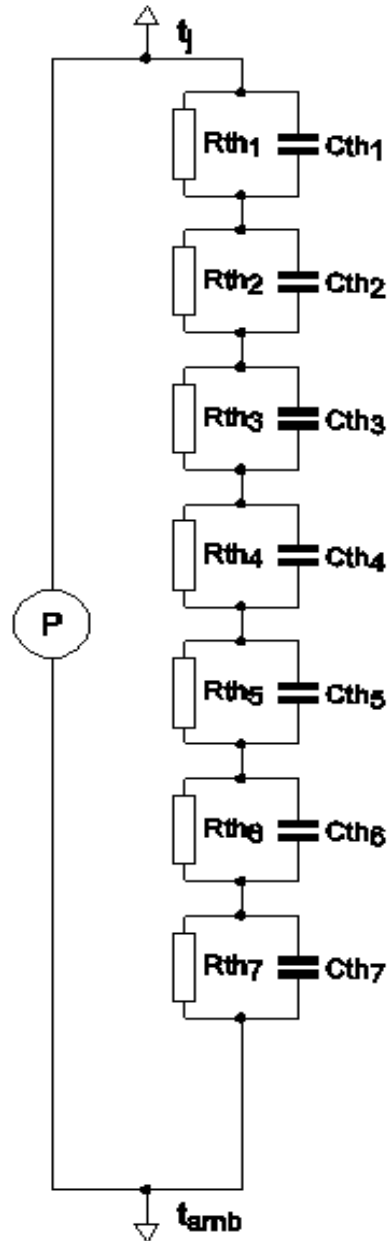

Part: BUK7Y1R7-40H

Date: 10/8/2017

Model Rth 0.51 K/W