

SPICE thermal model

BUK7Y2R5-40H

Symbol	Parameter	Conditions	Min	Typ	Max	Unit
$R_{th(j-mb)}$	thermal resistance from junction to mounting base		-	-	0.79	K/W

C_{th1}	2.534E-04 F
C_{th2}	2.227E-03 F
C_{th3}	9.008E-04 F
C_{th4}	1.423E-03 F
C_{th5}	6.543E-03 F
C_{th6}	7.146E-03 F
C_{th7}	1.602E+00 F
R_{th1}	3.840E-04 Ω
R_{th2}	5.954E-04 Ω
R_{th3}	1.439E-02 Ω
R_{th4}	6.853E-02 Ω
R_{th5}	2.076E-01 Ω
R_{th6}	4.868E-01 Ω
R_{th7}	1.174E-02 Ω

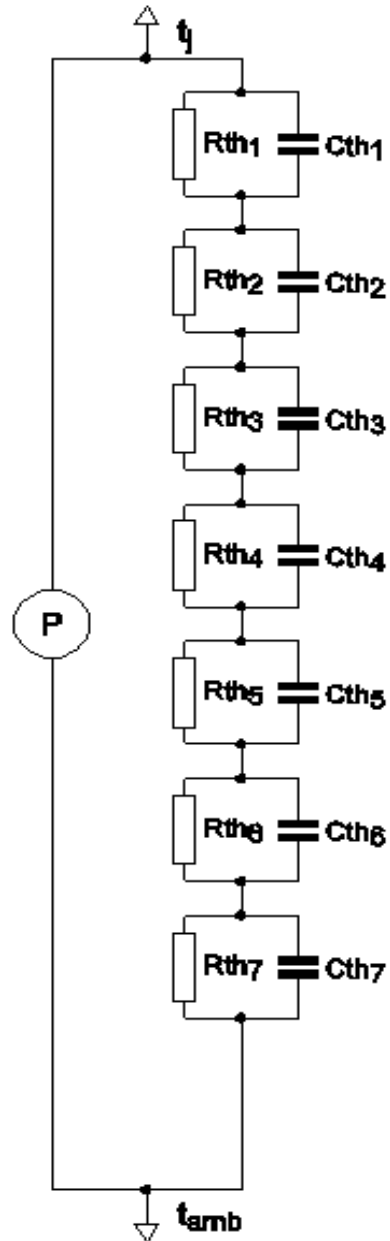

Part: BUK7Y2R5-40H

Date: 10/8/2017

Model Rth 0.79 K/W