

SPICE thermal model

BUK9M11-40H

Symbol	Parameter	Conditions	Min	Typ	Max	Unit
$R_{th(j-mb)}$	thermal resistance from junction to mounting base		-	-	3.00	K/W

C_{th1}	1.221E-05 F
C_{th2}	8.204E-05 F
C_{th3}	7.503E-04 F
C_{th4}	5.465E-03 F
C_{th5}	2.206E-01 F

R_{th1}	2.027E-02 Ω
R_{th2}	2.206E-01 Ω
R_{th3}	1.612E+00 Ω
R_{th4}	1.158E+00 Ω
R_{th5}	8.375E-05 Ω

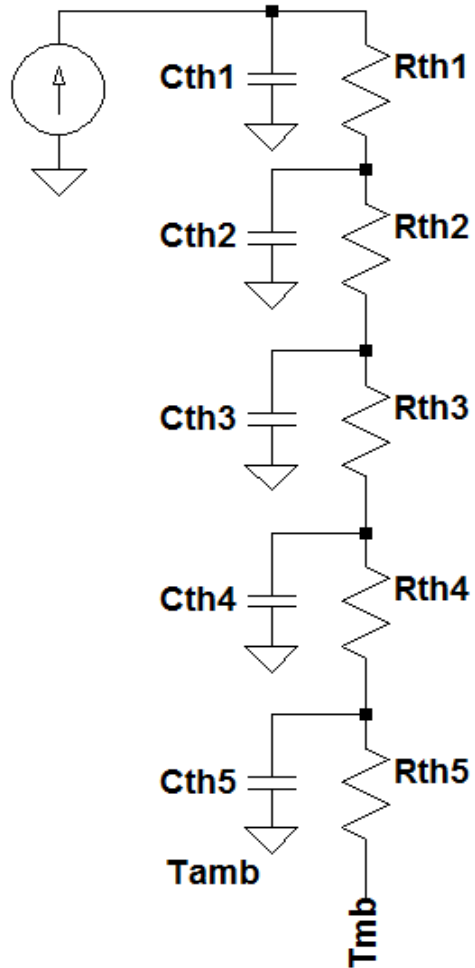

Part: BUK9M11-40H

Date: 24/1/2019

Model Rth 3.01 K/W