

### SPICE thermal model

BUK9M15-40H

Symbol	Parameter	Conditions	Min	Typ	Max	Unit
$R_{th(j-mb)}$	thermal resistance from junction to mounting base		-	-	3.44	K/W

$C_{th1}$	1.012E-05 F
$C_{th2}$	6.201E-05 F
$C_{th3}$	1.276E-05 F
$C_{th4}$	5.750E-04 F
$C_{th5}$	5.074E-03 F

$R_{th1}$	2.548E-02 $\Omega$
$R_{th2}$	2.585E-01 $\Omega$
$R_{th3}$	1.900E-02 $\Omega$
$R_{th4}$	1.958E+00 $\Omega$
$R_{th5}$	1.177E+00 $\Omega$

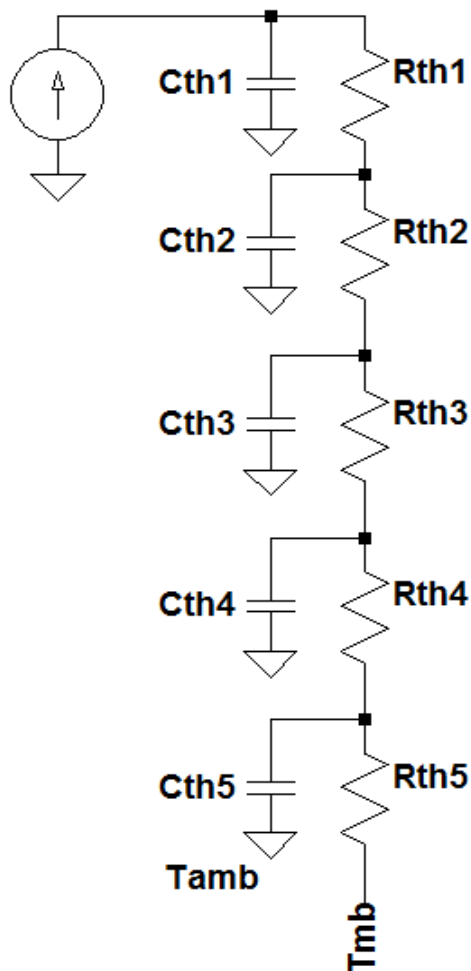

Part: BUK9M15-40H

Date: 24/1/2019

Model Rth 3.44 K/W