

SPICE thermal model

BUK9M20-40H

Symbol	Parameter	Conditions	Min	Typ	Max	Unit
$R_{th(j-mb)}$	thermal resistance from junction to mounting base		-	-	3.96	K/W

Cth ₁	8.282E-06 F
Cth ₂	4.562E-05 F
Cth ₃	4.213E-04 F
Cth ₄	3.287E-03 F
Cth ₅	1.521E-04 F

Rth ₁	3.232E-02 Ω
Rth ₂	3.410E-01 Ω
Rth ₃	2.144E+00 Ω
Rth ₄	1.320E+00 Ω
Rth ₅	1.166E-01 Ω

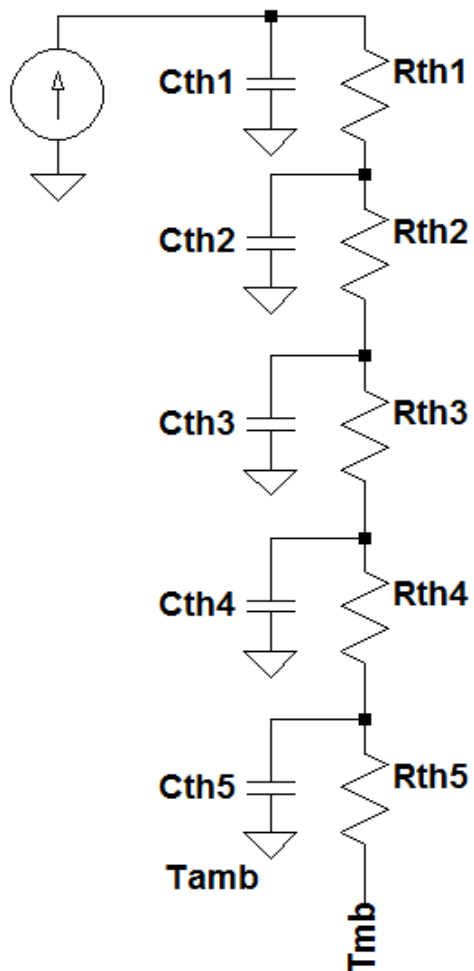

Part: BUK9M20-40H

Date: 24/1/2019

Model Rth 3.95 K/W