

SPICE thermal model

BUK9M6R7-40H

Symbol	Parameter	Conditions	Min	Typ	Max	Unit
$R_{th(j-mb)}$	thermal resistance from junction to mounting base		-	-	2.32	K/W

C_{th1}	1.714E-05 F
C_{th2}	1.015E-04 F
C_{th3}	1.135E-04 F
C_{th4}	1.282E-03 F
C_{th5}	1.882E-02 F

R_{th1}	1.136E-02 Ω
R_{th2}	4.814E-02 Ω
R_{th3}	1.087E-01 Ω
R_{th4}	1.481E+00 Ω
R_{th5}	6.691E-01 Ω

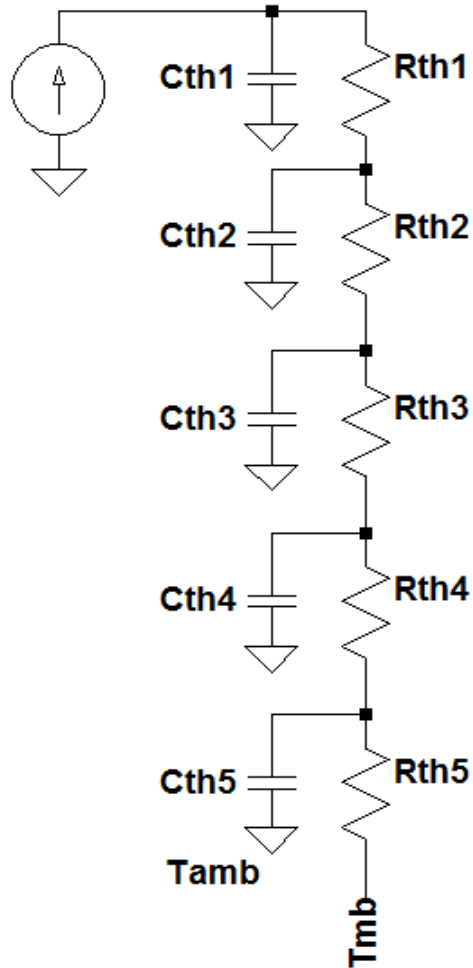

Part: BUK9M6R7-40H

Date: 24/1/2019

Model Rth 2.32 K/W