

### SPICE thermal model

BUK9M9R5-40H

Symbol	Parameter	Conditions	Min	Typ	Max	Unit
$R_{th(j-mb)}$	thermal resistance from junction to mounting base		-	-	2.74	K/W

$C_{th1}$	1.401E-05 F
$C_{th2}$	1.008E-04 F
$C_{th3}$	9.356E-04 F
$C_{th4}$	7.399E-03 F
$C_{th5}$	4.381E-04 F

$R_{th1}$	1.725E-02 $\Omega$
$R_{th2}$	1.902E-01 $\Omega$
$R_{th3}$	1.560E+00 $\Omega$
$R_{th4}$	4.929E-02 $\Omega$
$R_{th5}$	9.204E-01 $\Omega$

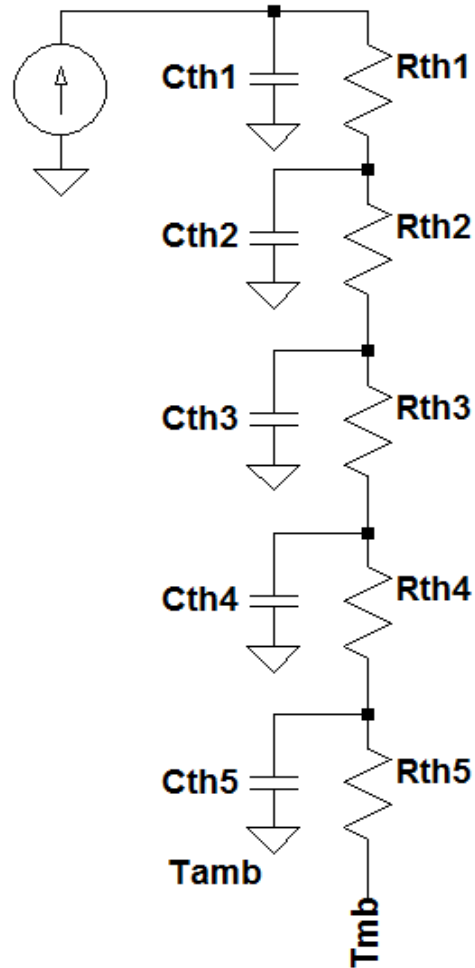

Part: BUK9M9R5-40H

Date: 24/1/2019

Model Rth 2.74 K/W