

SPICE thermal model

BUK9Y1R9-40H

Symbol	Parameter	Conditions	Min	Typ	Max	Unit
$R_{th(j-mb)}$	thermal resistance from junction to mounting base		-	-	0.69	K/W

C_{th1}	7.833E-03 F
C_{th2}	3.864E-02 F
C_{th3}	1.054E-03 F
C_{th4}	6.885E-03 F
C_{th5}	2.575E-03 F

R_{th1}	0.388643 Ω
R_{th2}	0.182971 Ω
R_{th3}	0.006895 Ω
R_{th4}	0.07669 Ω
R_{th5}	0.031096 Ω

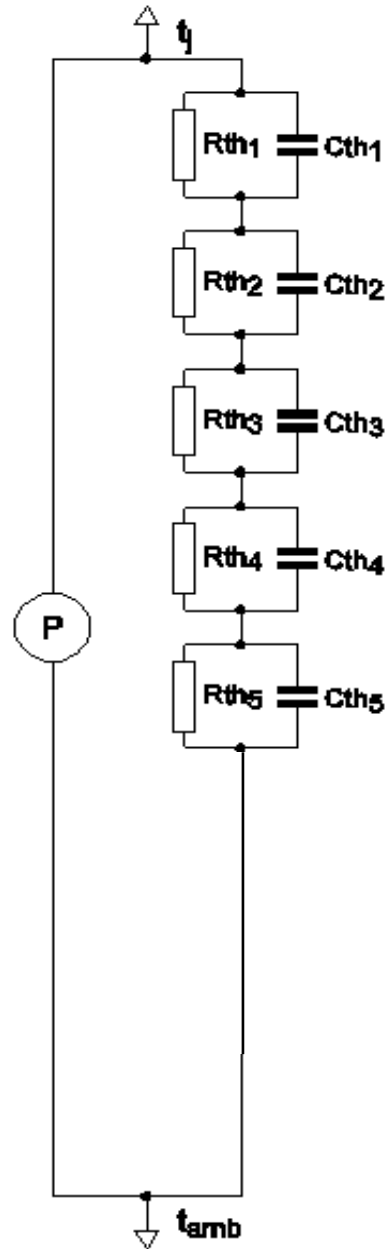

Part: BUK9Y1R9-40H

Date: 4/5/2018

Model Rth 0.69 K/W