

Important notice

Dear Customer,

On 7 February 2017 the former NXP Standard Product business became a new company with the tradename **Nexperia**. Nexperia is an industry leading supplier of Discrete, Logic and PowerMOS semiconductors with its focus on the automotive, industrial, computing, consumer and wearable application markets

In data sheets and application notes which still contain NXP or Philips Semiconductors references, use the references to Nexperia, as shown below.

Instead of <http://www.nxp.com>, <http://www.philips.com/> or <http://www.semiconductors.philips.com/>, use <http://www.nexperia.com>

Instead of sales.addresses@www.nxp.com or sales.addresses@www.semiconductors.philips.com, use salesaddresses@nexperia.com (email)

Replace the copyright notice at the bottom of each page or elsewhere in the document, depending on the version, as shown below:

- © NXP N.V. (year). All rights reserved or © Koninklijke Philips Electronics N.V. (year). All rights reserved

Should be replaced with:

- © **Nexperia B.V. (year). All rights reserved.**

If you have any questions related to the data sheet, please contact our nearest sales office via e-mail or telephone (details via salesaddresses@nexperia.com). Thank you for your cooperation and understanding,

Kind regards,

Team Nexperia

SPICE thermal model

BUK9Y22-30B

Symbol	Parameter	Conditions	Min	Typ	Max	Unit
$R_{th(j-mb)}$	thermal resistance from junction to mounting base		-	-	2.53	K/W

C_{th1}	1.131E-02 F
C_{th2}	1.786E-03 F
C_{th3}	4.474E-04 F
C_{th4}	1.121E-04 F
C_{th5}	2.808E-05 F
C_{th6}	7.035E-06 F
C_{th7}	1.763E-06 F
C_{th8}	4.416E-07 F
R_{th1}	1.591E+00 Ω
R_{th2}	6.822E-01 Ω
R_{th3}	1.843E-01 Ω
R_{th4}	4.977E-02 Ω
R_{th5}	1.344E-02 Ω
R_{th6}	3.631E-03 Ω
R_{th7}	9.809E-04 Ω
R_{th8}	2.650E-04 Ω

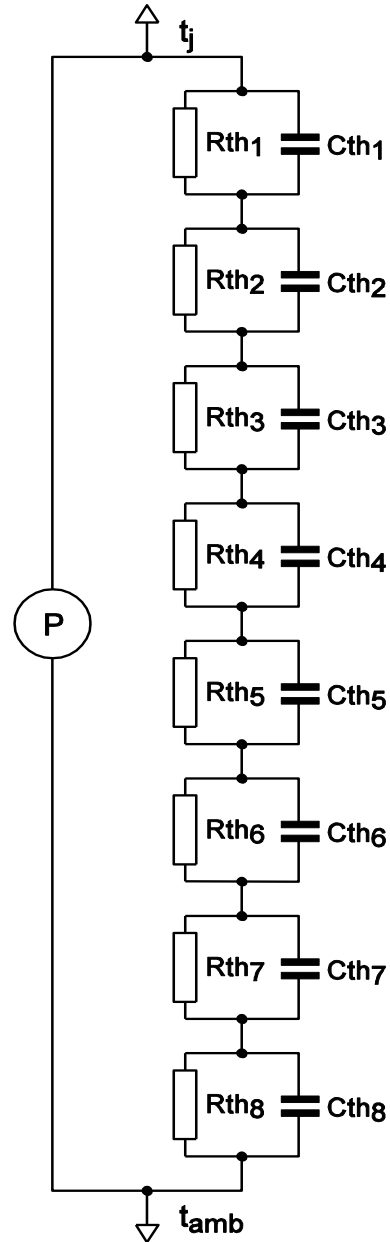

001aal768

Part: BUK9Y22-30B
 Version: 1
 Date: 23-3-2010
 Rth: 2.53