

SPICE thermal model

BUK9Y2R8-40H

Symbol	Parameter	Conditions	Min	Typ	Max	Unit
$R_{th(j-mb)}$	thermal resistance from junction to mounting base		-	-	0.87	K/W

C_{th1} 4.439E-03 F
 C_{th2} 1.805E-02 F
 C_{th3} 6.590E-04 F
 C_{th4} 6.963E-03 F
 C_{th5} 1.482E-03 F

R_{th1} 0.470906 Ω
 R_{th2} 0.281501 Ω
 R_{th3} 0.011792 Ω
 R_{th4} 0.052367 Ω
 R_{th5} 0.049415 Ω

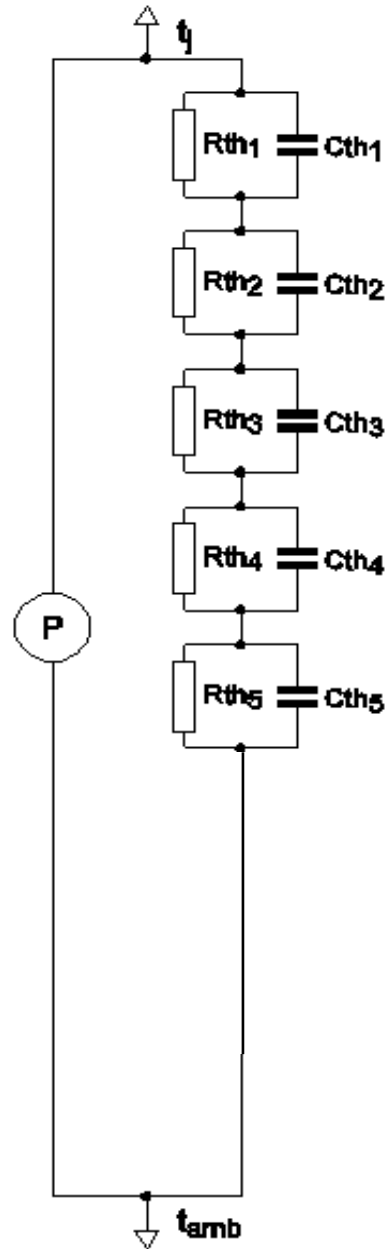

Part: BUK9Y2R8-40H

Date: 4/5/2018

Model Rth 0.87 K/W