

SPICE thermal model

PSMN0R9-25YLC

Symbol	Parameter	Conditions	Min	Typ	Max	Unit
$R_{th(j-mb)}$	thermal resistance from junction to mounting base		-	-	0.55	K/W

C_{th1}	1.038E-04 F
C_{th2}	4.667E-04 F
C_{th3}	6.025E-04 F
C_{th4}	2.970E-03 F
C_{th5}	2.137E-02 F
C_{th6}	1.463E-02 F
C_{th7}	7.042E+03 F
R_{th1}	8.791E-04 Ω
R_{th2}	2.288E-03 Ω
R_{th3}	1.673E-02 Ω
R_{th4}	2.591E-02 Ω
R_{th5}	5.146E-02 Ω
R_{th6}	4.527E-01 Ω
R_{th7}	8.981E-06 Ω

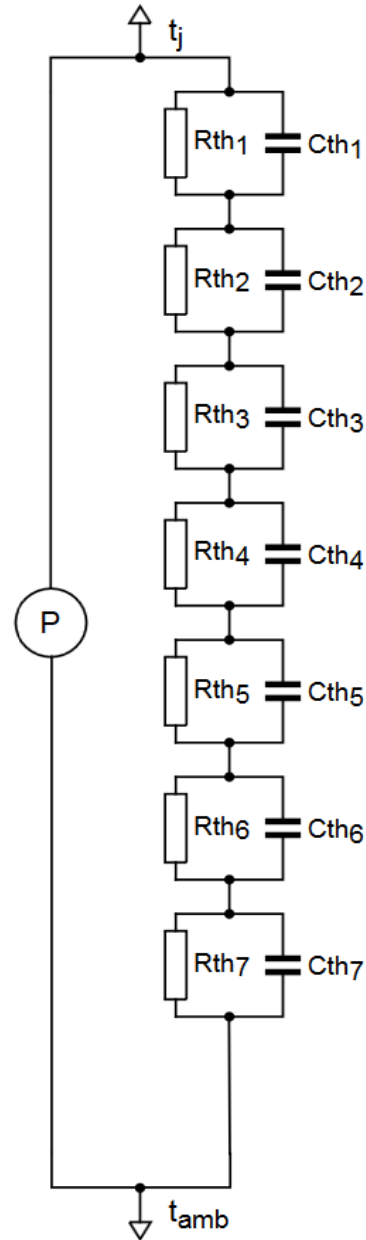

Part: PSMN0R9-25YLC

Date: 31/10/2018

Model Rth 0.55 K/W