

BTS7205U

3.3 GHz - 4.2 GHz RX Analog Front-End Module with bypass

Rev. 7 — 7 June 2022

Product data sheet

1 General description

The BTS7205U is a dual channel Receiver Analog Front-End module (RX AFE) available in a leadframe HVQFN package.

The BTS7205U is designed for 5G mMIMO Infrastructure applications. The BTS7205U includes 2 independent receive channels with a low noise amplifier (LNA) with variable gain control. Each channel also has a switch for high-power TX signals. In addition, each channel has a separate TX signal bypass to RX output via a coupler.

The device is matched to 50 Ω and integrates harmonic and out-of-band filtering which minimizes the layout area in the application.

2 Features and benefits

- Operating frequency range 3.3 GHz - 4.2 GHz
- 170 mW power dissipation per channel
- RX power gain 36 dB
- RX power gain attenuation step 6 dB
- Typical Noise Figure 1.3 dB
- High TX power handling 37 dBm (9 dB PAPR)
- Single-ended input /output RF ports matched to 50 Ω
- Fast switching time between operation modes
- TX signal bypass via coupler to RX output
- ESD protection on all pins
- Leadframe HVQFN package 5.0 mm x 5.0 mm x 0.85 mm with 32 pins

3 Applications

- 5G mMIMO
- Wireless Infrastructure



4 Quick reference data

Table 1. Quick reference data

$f = 3.75 \text{ GHz}$; $V_{CC} = 3.3 \text{ V}$, $T_{case} = 50 \text{ }^\circ\text{C}$; input and output $50 \text{ } \Omega$; unless otherwise specified.

Symbol	Parameter	Conditions	Min	Typ	Max	Unit
High gain RX mode; signal from ANT to RX_OUT						
I_{CC}	supply current		-	51	57	mA
G_p	power gain		34.5	36	37.5	dB
NF	noise figure		-	1.3	1.4	dB
$IP3_o$	output third-order intercept point	2-tones at 10 MHz distance, $P_i = -40 \text{ dBm}$ each tone	20	23	-	dBm
$P_{i(1dB)}$	input power at 1 dB gain compression		-25	-24	-	dBm
Low gain RX mode; signal from ANT to RX_OUT						
I_{CC}	supply current		-	51	57	mA
G_p	power gain		28.5	30	31.5	dB
α_{step}	attenuation step		5.3	6	6.4	dB
NF	noise figure		-	1.5	1.6	dB
$IP3_o$	output third-order intercept point	2-tones at 10 MHz distance, $P_i = -40 \text{ dBm}$ each tone	-	22	-	dBm
$P_{i(1dB)}$	input power at 1 dB gain compression		-19	-18	-	dBm
TX mode; signal from ANT to TERM						
I_{CC}	supply current		-	5.9	6.5	mA
$P_{i(AV)TX}$	maximum average input power in TX mode ^[1]	applied on ANT pin, 10 years, $T_{case(AV)} = 99 \text{ }^\circ\text{C}$ ^[2]	34	-	-	dBm
		applied on ANT pin, 10 seconds, $T_{case} = 105 \text{ }^\circ\text{C}$ ^[3]	37	-	-	dBm
TX bypass mode: Signal from ANT to RX_OUT via coupler						
G_p	power gain		-32	-29	-27.5	dB

[1] CP-OFDM with 9 dB PAPR, BW = 100 MHz, QPSK modulated, SCS = 60 kHz, fully allocated

[2] $T_{case(AV)}$ is an equivalent temperature that yields the same aging over life time as the expected temperature profile which includes temperatures up to $105 \text{ }^\circ\text{C}$

[3] See [Table 7](#)

5 Ordering information

Table 2. Ordering information

Type number	Orderable part number	Package		
		Name	Description	Version
BTS7205U	BTS7205UHP	HVQFN32	Plastic thermal enhanced very thin quad flat package; no leads; 32 terminals; body 5.0 mm x 5.0 mm x 0.85 mm	SOT617-3

6 Marking

Table 3. Marking

Type number	Marking code
BTS7205U	7205U

7 Functional diagram

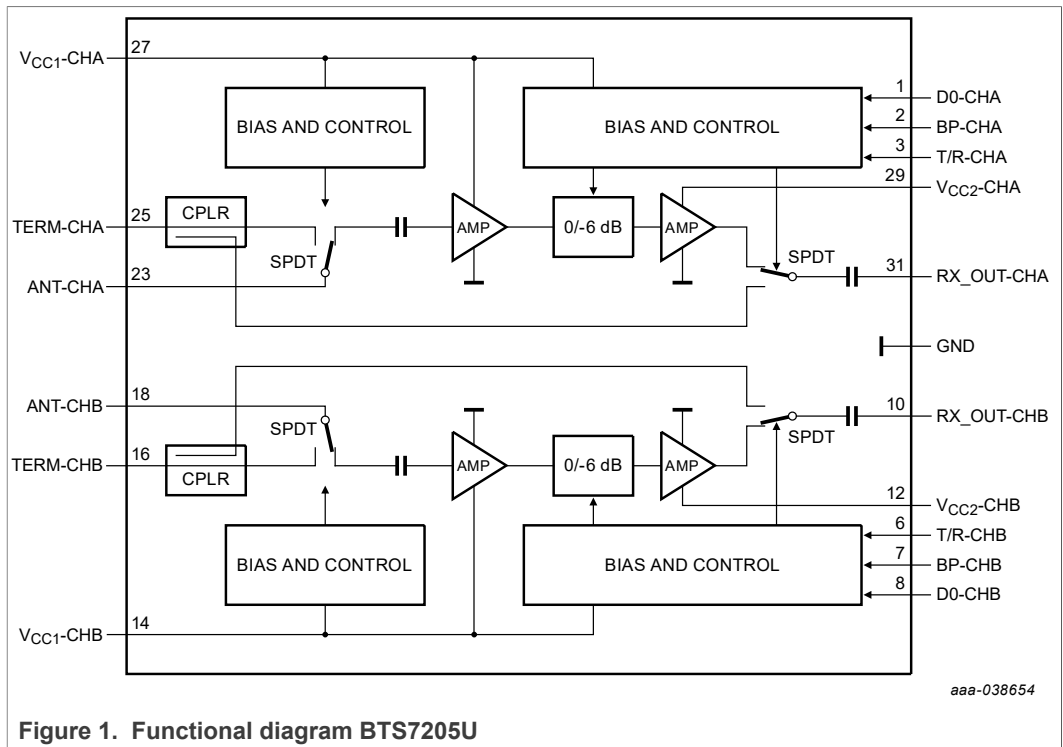
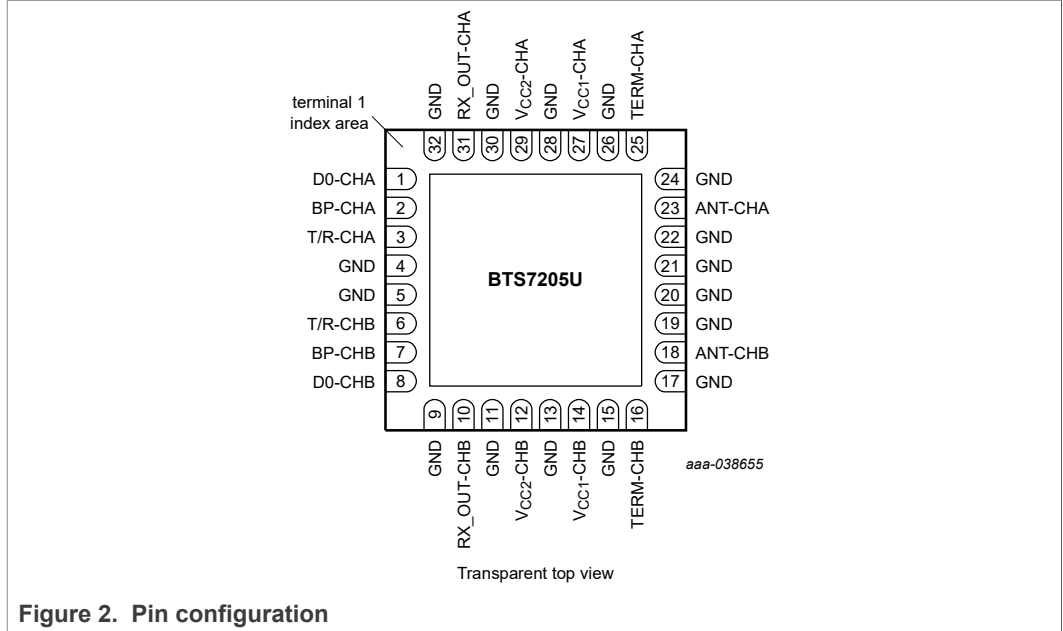

Figure 1. Functional diagram BTS7205U

8 Pinning information

8.1 Pin diagram



8.2 Pin description

Table 4.

Pin	Symbol	Description
1	D0-CHA	Select attenuation for channel A
2	BP-CHA	Bypass switch control for channel A
3	T/R-CHA	Select RX mode / TX mode for channel A
4, 5, 9, 11, 13, 15, 17, 19, 20, 21, 22, 24, 26, 28, 30, and 32	GND	Ground reference
6	T/R-CHB	Select RX mode / TX mode for channel B
7	BP-CHB	Bypass switch control for channel B
8	D0-CHB	Select attenuation for channel B
10	RX_OUT-CHB	RF output for channel B (50 Ω, single ended)
12, 14	V _{CC} -CHB	Supply voltage for channel B
16	TERM-CHB	Termination RF output for channel B (50 Ω, single ended, DC at 0 V)
18	ANT-CHB	RF input for channel B (50 Ω, single ended, DC at 0 V)
23	ANT-CHA	RF input for channel A (50 Ω, single ended, DC at 0 V)
25	TERM-CHA	Termination RF output for channel A (50 Ω, single ended, DC at 0 V)
27, 29	V _{CC} -CHA	Supply voltage for channel A
31	RX_OUT-CHA	RF output for channel A (50 Ω, single ended)
Die paddle	GND	Ground reference

9 Functional description

9.1 Modes of operation

Table 5. Modes of operation for channel A

T/R-CHA	BP-CHA	D0-CHA	Mode of Operation
Low	Low/High	Low	RX High gain mode for channel A
Low	Low/High	High	RX 6 dB reduced-gain mode for channel A
High	Low	Low/High	TX mode for channel A
High	High	Low/High	TX with bypass mode for channel A

Table 6. Modes of operation for channel B

T/R-CHB	BP-CHB	D0-CHB	Mode of Operation
Low	Low/High	Low	RX High gain mode for channel B
Low	Low/High	High	RX 6 dB reduced-gain mode for channel B
High	Low	Low/High	TX mode for channel B
High	High	Low/High	TX with bypass mode for channel B

10 Limiting values

Table 7. Limiting values

In accordance with the Absolute Maximum Rating System (IEC 60134)

Symbol	Parameter	Conditions	Min	Max	Unit
V _{CC}	supply voltage		-0.3	6	V
VDC _(ctrl_pins)	DC voltage on control pins	applied on control pins D0, BP, and T/R	-0.3	3.45	V
VDC _(RF_pins)	DC voltage on RF pins	applied on both ANT, and both TERM, RF pins	0	0	V
P _{I(AV)RX}	average input power in RX mode ^[1]	applied on ANT pin, 24 hours, T _{case} = 105 °C	-	11	dBm
P _{I(AV)TX}	average input power in TX mode ^[1]	applied on ANT pin, 10 seconds, T _{case} = 105 °C	37	39	dBm
T _{stg}	storage temperature		-40	150	°C
T _j	junction temperature		-	150	°C
V _{ESD}	electrostatic discharge voltage	Human Body Model (HBM) according to ANSI/ESDA/JEDEC standard JS-001	-2	2	kV
		Charged Device Model (CDM) according to ANSI/ESDA/JEDEC standard JS-002	-500	500	V

[1] CP-OFDM with 9 dB PAPR, BW = 100 MHz, QPSK modulated, SCS = 60 kHz, fully allocated

11 Recommended operating conditions

Table 8. Recommended operating conditions

Symbol	Parameter	Conditions	Min	Typ	Max	Unit
f _{oper}	operating frequency		3.3	-	4.2	GHz
Z ₀	characteristic impedance		-	50	-	Ω
V _{CC}	supply voltage	on pins V _{CC1} , and V _{CC2} ^[1]	3.15	3.3	3.45	V
V _{IH}	HIGH-level input voltage	at pins D0, BP, and T/R	1.2	1.8	2.5	V
V _{IL}	LOW-level input voltage	at pins D0, BP, and T/R	0	-	0.6	V
T _{case}	case temperature	exposed die paddle at package bottom	-40	50	105	°C

[1] channel A and channel B can be used independently

12 Thermal characteristics

Table 9. Thermal characteristics

Symbol	Parameter	Conditions	Min	Typ	Max	Unit
R _{th(j-case)}	channel-junction to case thermal resistance	TX mode	-	49	-	K/W
		RX mode	-	55	-	K/W

13 Characteristics

Table 10. Characteristics

$f = 3.75 \text{ GHz}$; $V_{CC} = 3.3 \text{ V}$, $T_{case} = 50 \text{ }^\circ\text{C}$; input and output $50 \text{ } \Omega$; unless otherwise specified.

Characteristics apply to each channel A and B separately.

Symbol	Parameter	Conditions	Min	Typ	Max	Unit
High gain RX mode; signal from ANT to RX_OUT						
I_{cc}	supply current		-	51	57	mA
G_p	power gain		34.5	36	37.5	dB
		$f = 3.3 \text{ GHz to } 4.2 \text{ GHz}$, $T_{case} = -40 \text{ }^\circ\text{C to } 105 \text{ }^\circ\text{C}$	33.5	-	39	dB
G_{flat}	gain flatness	in 200 MHz band	-	-	0.5	dB
NF	noise figure		-	1.3	1.4	dB
		$f = 3.3 \text{ GHz to } 4.2 \text{ GHz}$, $T_{case} = -40 \text{ }^\circ\text{C to } 105 \text{ }^\circ\text{C}$	-	-	1.7	dB
RL_i	input return loss	$f = 3.3 \text{ GHz to } 4.2 \text{ GHz}$	12	17	-	dB
RL_o	output return loss	$f = 3.3 \text{ GHz to } 4.2 \text{ GHz}$	12	17	-	dB
$RL_{align(RX-TX)}$	return loss alignment RX-TX	$R_{TERM} = 50 \text{ } \Omega$, $f = 3.3 \text{ GHz to } 4.2 \text{ GHz}$	12	-	-	dB
$\alpha_{isol(ch-ch)}$	isolation channel to channel	$f = 3.3 \text{ GHz to } 4.2 \text{ GHz}$ ^[1]	40	42	-	dB
$G_{rel(f2/f0)}$	relative gain (G_{r2}/G_{f0})	$f_0 = 3.3 \text{ GHz to } 4.2 \text{ GHz}$, $f_2 = 2 \times f_0$	-	-35	-25	dB
$G_{rel(f3/f0)}$	relative gain (G_{r3}/G_{f0})	$f_0 = 3.3 \text{ GHz to } 4.2 \text{ GHz}$, $f_3 = 3 \times f_0$	-	-50	-45	dB
α_{2Ho}	output second harmonic level	$P_o = 0 \text{ dBm}$	-	-56	-40	dBm
α_{3Ho}	output third harmonic level	$P_o = 0 \text{ dBm}$	-	-69	-58	dBm
IP3 _o	output third-order intercept point	2-tones at 10 MHz distance, $P_i = -40 \text{ dBm}$ each tone	20	23	-	dBm
		2-tones at 10 MHz distance, $P_i = -40 \text{ dBm}$ each tone, $f_0 = 3.3 \text{ GHz to } 4.2 \text{ GHz}$, $T_{case} = -40 \text{ }^\circ\text{C to } 105 \text{ }^\circ\text{C}$	18	-	-	dBm
$P_{i(1dB)}$	input power at 1 dB gain compression		-25	-24	-	dBm
K	stability factor	1 MHz to 20 GHz, $T_{case} = -40 \text{ }^\circ\text{C to } 105 \text{ }^\circ\text{C}$	1	-	-	-
Low gain RX mode; signal from ANT to RX_OUT						
I_{cc}	supply current		-	51	57	mA
G_p	power gain		28.5	30	31.5	dB
		$f = 3.3 \text{ GHz to } 4.2 \text{ GHz}$, $T_{case} = -40 \text{ }^\circ\text{C to } 105 \text{ }^\circ\text{C}$	27.5	-	33	dB
α_{step}	attenuation step		5.3	6	6.4	dB
G_{flat}	gain flatness	in 200 MHz band	-	-	1.55	dB
NF	noise figure		-	1.5	1.6	dB
		$f = 3.3 \text{ GHz to } 4.2 \text{ GHz}$, $T_{case} = -40 \text{ }^\circ\text{C to } 105 \text{ }^\circ\text{C}$	-	-	2.3	dB
RL_i	input return loss	$f = 3.3 \text{ GHz to } 4.2 \text{ GHz}$	12	17	-	dB
RL_o	output return loss	$f = 3.3 \text{ GHz to } 4.2 \text{ GHz}$	12	17	-	dB
$RL_{align(RX-TX)}$	return loss alignment RX-TX	$R_{TERM} = 50 \text{ } \Omega$, $f = 3.3 \text{ GHz to } 4.2 \text{ GHz}$	12	-	-	dB

3.3 GHz - 4.2 GHz RX Analog Front-End Module with bypass

Table 10. Characteristics...continued

$f = 3.75 \text{ GHz}$; $V_{CC} = 3.3 \text{ V}$, $T_{case} = 50 \text{ }^\circ\text{C}$; input and output $50 \text{ } \Omega$; unless otherwise specified.

Characteristics apply to each channel A and B separately.

Symbol	Parameter	Conditions	Min	Typ	Max	Unit
$\alpha_{isol(ch-ch)}$	isolation channel to channel	$f = 3.3 \text{ GHz to } 4.2 \text{ GHz}$ ^[1]	40	42	-	dB
$G_{rel(f_2/f_0)}$	relative gain (G_{f_2}/G_{f_0})	$f_0 = 3.3 \text{ GHz to } 4.2 \text{ GHz}$, $f_2 = 2 \times f_0$	-	-35	-25	dB
$G_{rel(f_3/f_0)}$	relative gain (G_{f_3}/G_{f_0})	$f_0 = 3.3 \text{ GHz to } 4.2 \text{ GHz}$, $f_3 = 3 \times f_0$	-	-50	-45	dB
α_{2Ho}	output second harmonic level	$P_o = 0 \text{ dBm}$	-	-56	-45	dBm
α_{3Ho}	output third harmonic level	$P_o = 0 \text{ dBm}$	-	-65	-55	dBm
IP_{3o}	output third-order intercept point	2-tones at 10 MHz distance, $P_1 = -40 \text{ dBm}$ each tone	20	22	-	dBm
		2-tones at 10 MHz distance, $P_1 = -40 \text{ dBm}$ each tone, $f_0 = 3.3 \text{ GHz to } 4.2 \text{ GHz}$, $T_{case} = -40 \text{ }^\circ\text{C to } 105 \text{ }^\circ\text{C}$	17	-	-	dBm
$P_{I(1dB)}$	input power at 1 dB gain compression		-19	-18	-	dBm
K	stability factor	1 MHz to 20 GHz, $T_{case} = -40 \text{ }^\circ\text{C to } 105 \text{ }^\circ\text{C}$	1	-	-	-
TX mode; signal from ANT to TERM						
I_{cc}	supply current		-	5.9	6.5	mA
IL	insertion loss	from ANT to TERM	-	0.55	0.6	dB
RL_i	input return loss	$f = 3.3 \text{ GHz to } 4.2 \text{ GHz}$	12	22	-	dB
RL_o	output return loss	$f = 3.3 \text{ GHz to } 4.2 \text{ GHz}$	12	22	-	dB
$\alpha_{isol(ANT-RX)}$	isolation between ANT to RX_OUT	$f = 3.3 \text{ GHz to } 4.2 \text{ GHz}$	55	-	-	dB
$P_{I(AV)TX}$	Maximum average input power in TX mode ^[2]	applied on ANT pin, lifetime (10 yrs), $T_{case(AV)} = 99 \text{ }^\circ\text{C}$ ^[3]	34	-	-	dBm
TX bypass mode: Signal from ANT to RX_OUT via coupler						
I_{CC}	supply current		-	5.9	6.5	mA
G_p	power gain		-32	-29	-27.5	dB
RL_i	input return loss	$f = 3.3 \text{ GHz to } 4.2 \text{ GHz}$	12	25	-	dB
RL_o	output return loss	$f = 3.3 \text{ GHz to } 4.2 \text{ GHz}$	9	17	-	dB
Switching between modes						
$t_{sw(\alpha)RX}$	switching time RX attenuation		-	-	100	ns
$t_{sw(RX-TX)}$	switching from RX to TX	for the power transient at RX_OUT	-	-	0.5	μs
$t_{sw(TX-RX)}$	switching from TX to RX		-	-	1	μs
$t_{sw(TX-bypass)}$	switching to TX bypass		-	-	1	μs

[1] G_p [ANT-CHA, RX_OUT-CHA] / G_p [ANT-CHB, RX_OUT-CHA]

[2] CP-OFDM with 9 dB PAPR, BW = 100 MHz, QPSK modulated, SCS = 60 kHz, fully allocated

[3] $T_{case(AV)}$ is an equivalent temperature that yields the same aging over life time as the expected temperature profile which includes temperatures up to 105 °C

14 Graphs

14.1 All modes

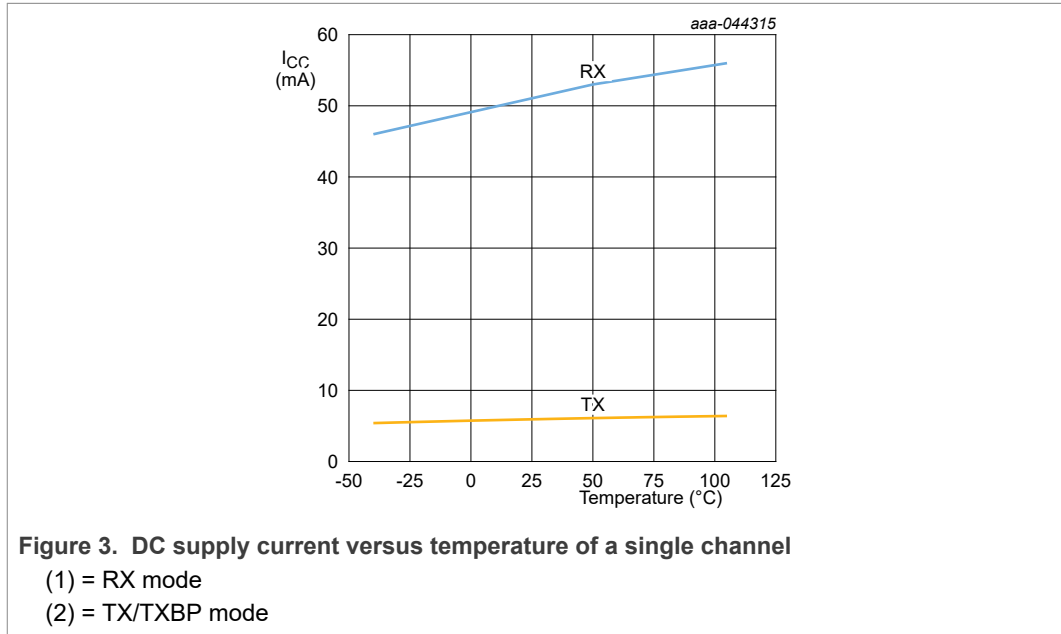

14.2 High gain RX mode

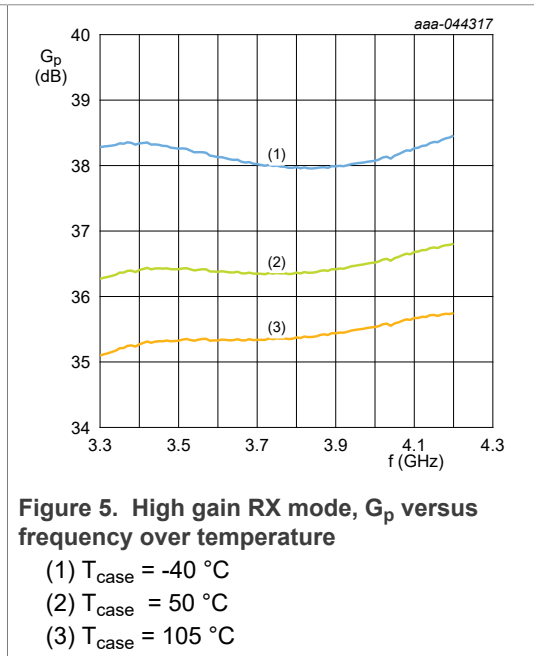
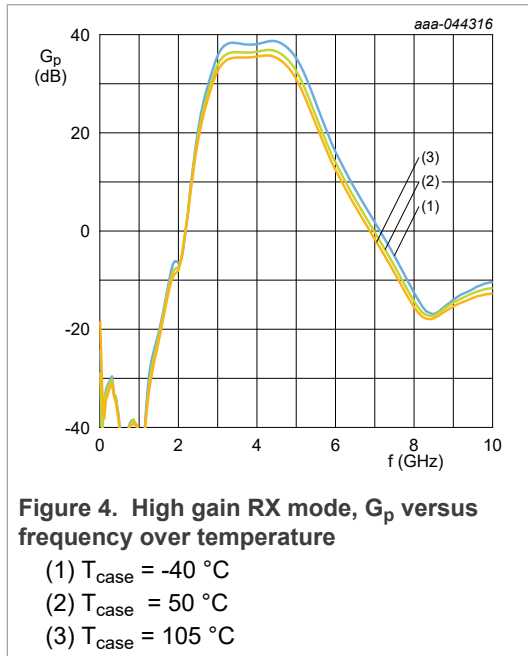

3.3 GHz - 4.2 GHz RX Analog Front-End Module with bypass

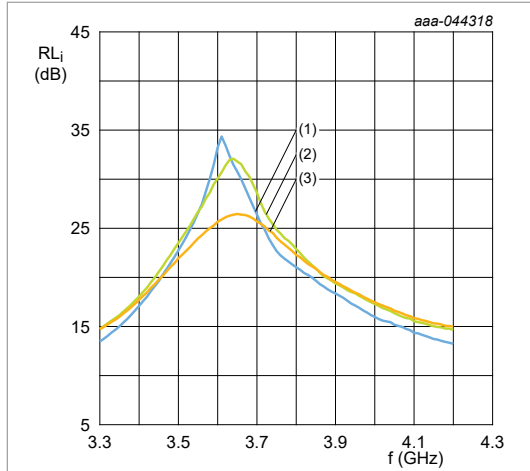

Figure 6. High gain RX mode, RL_i versus frequency over temperature
 (1) $T_{case} = -40\text{ °C}$
 (2) $T_{case} = 50\text{ °C}$
 (3) $T_{case} = 105\text{ °C}$

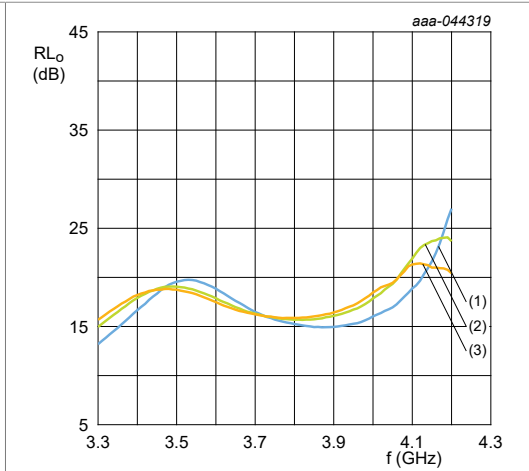

Figure 7. High gain RX mode, RL_o versus frequency over temperature
 (1) $T_{case} = -40\text{ °C}$
 (2) $T_{case} = 50\text{ °C}$
 (3) $T_{case} = 105\text{ °C}$

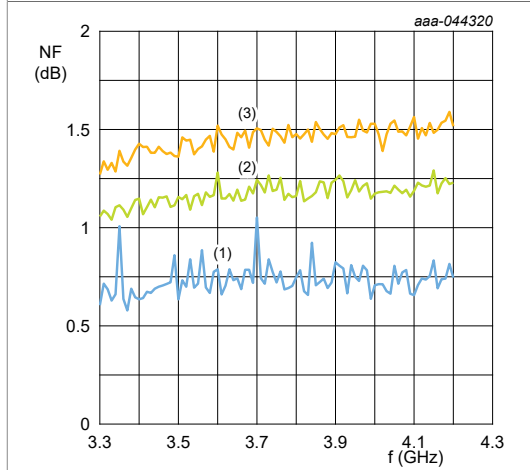

Figure 8. High gain RX mode, NF versus frequency over temperature
 (1) $T_{case} = -40\text{ °C}$
 (2) $T_{case} = 50\text{ °C}$
 (3) $T_{case} = 105\text{ °C}$

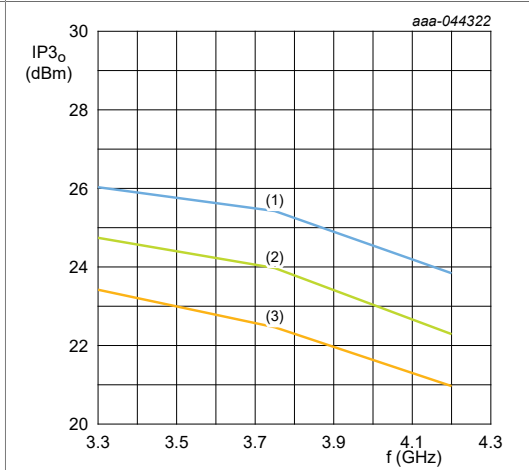
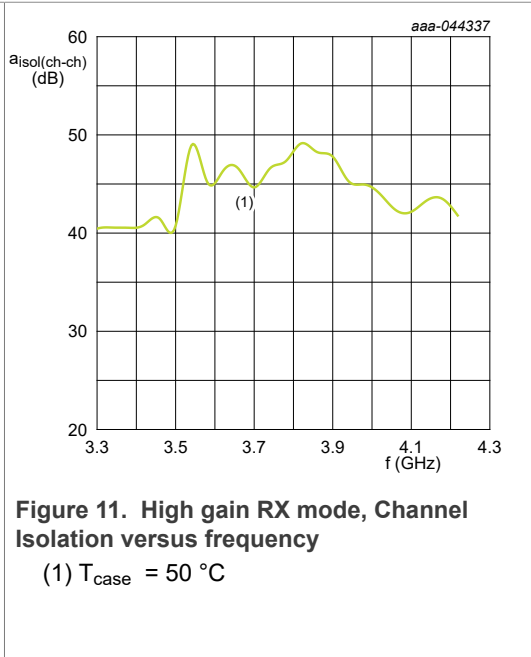
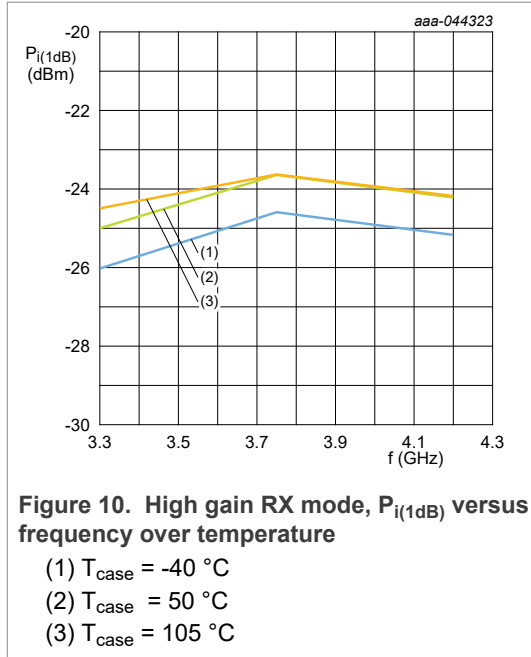
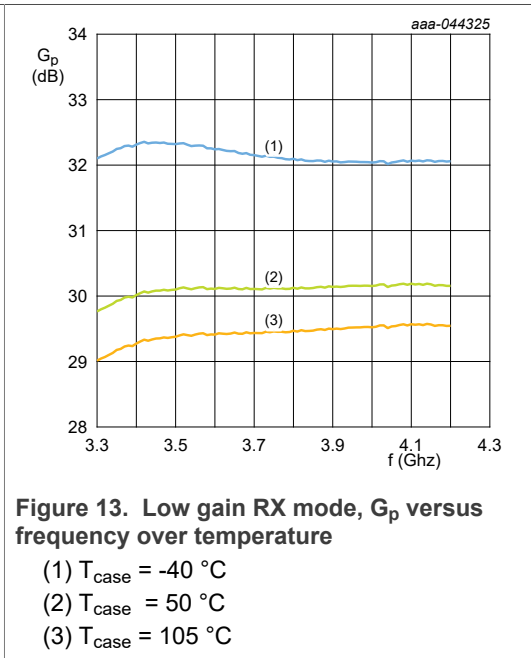
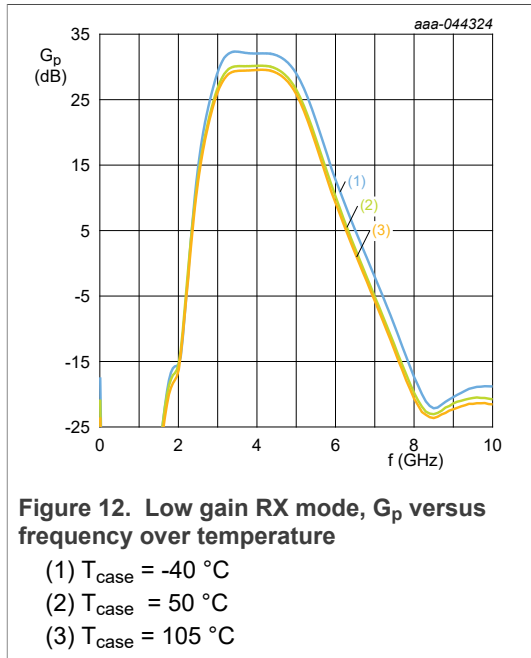

Figure 9. High gain RX mode, $IP3_o$ versus frequency over temperature
 (1) $T_{case} = -40\text{ °C}$
 (2) $T_{case} = 50\text{ °C}$
 (3) $T_{case} = 105\text{ °C}$

3.3 GHz - 4.2 GHz RX Analog Front-End Module with bypass



14.3 Low gain RX mode



3.3 GHz - 4.2 GHz RX Analog Front-End Module with bypass

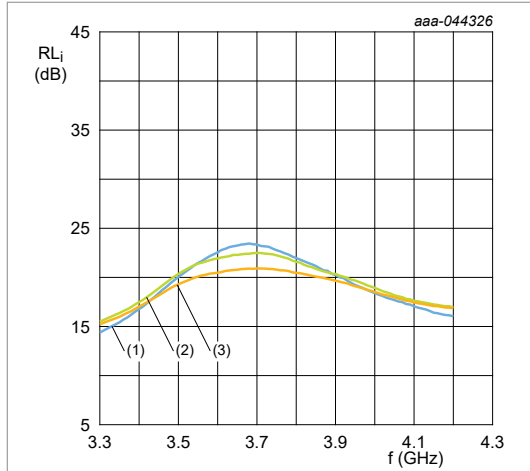

Figure 14. Low gain RX mode, RL_i versus frequency over temperature
 (1) $T_{case} = -40\text{ °C}$
 (2) $T_{case} = 50\text{ °C}$
 (3) $T_{case} = 105\text{ °C}$

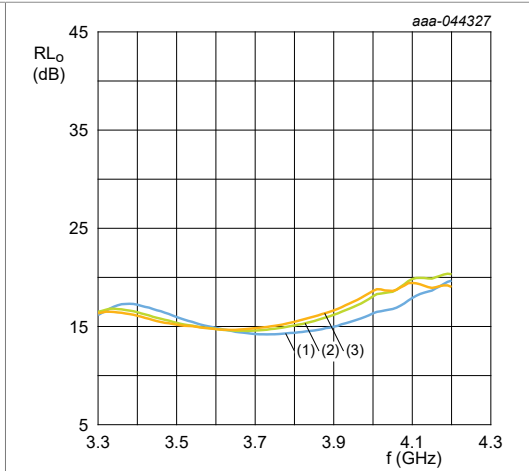

Figure 15. Low gain RX mode, RL_o versus frequency over temperature
 (1) $T_{case} = -40\text{ °C}$
 (2) $T_{case} = 50\text{ °C}$
 (3) $T_{case} = 105\text{ °C}$

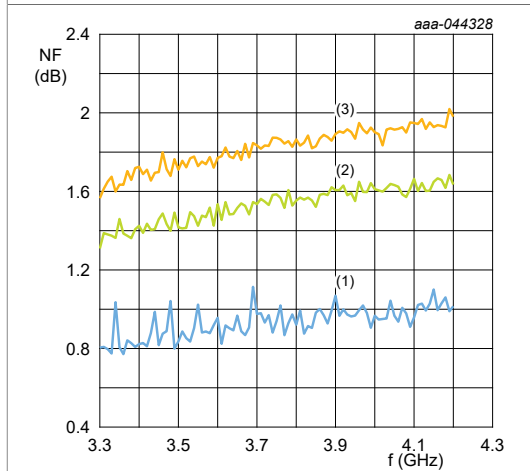

Figure 16. Low gain RX mode, NF versus frequency over temperature
 (1) $T_{case} = -40\text{ °C}$
 (2) $T_{case} = 50\text{ °C}$
 (3) $T_{case} = 105\text{ °C}$

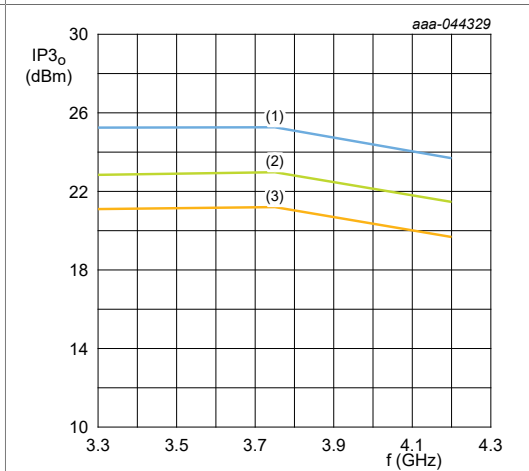
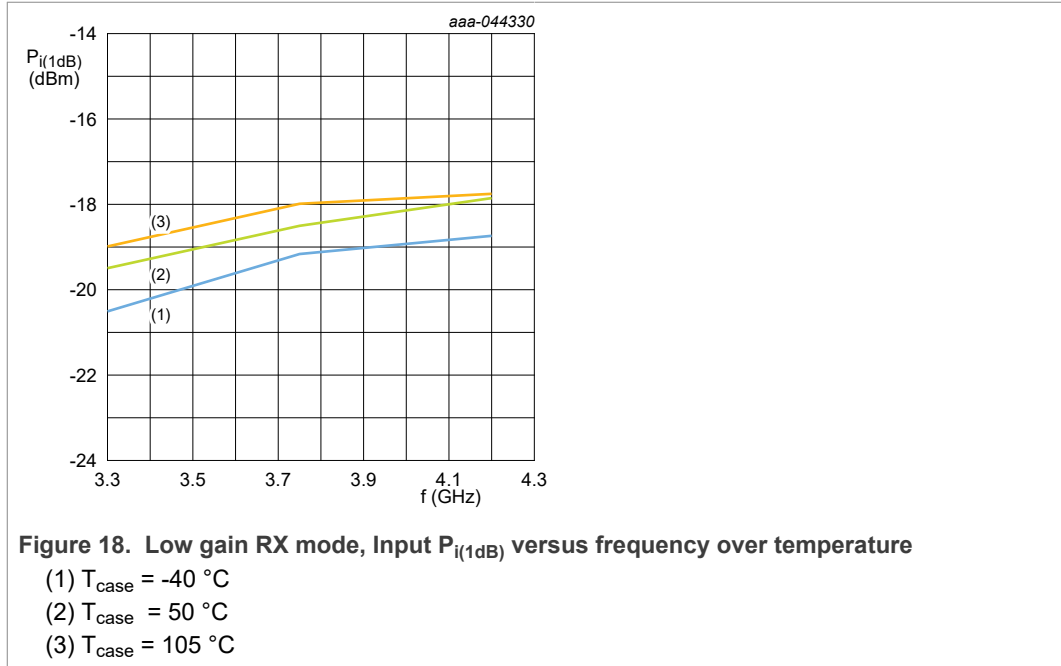
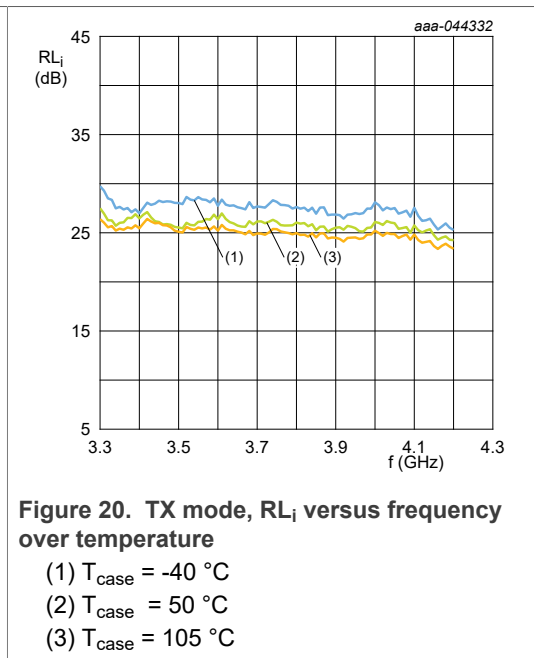
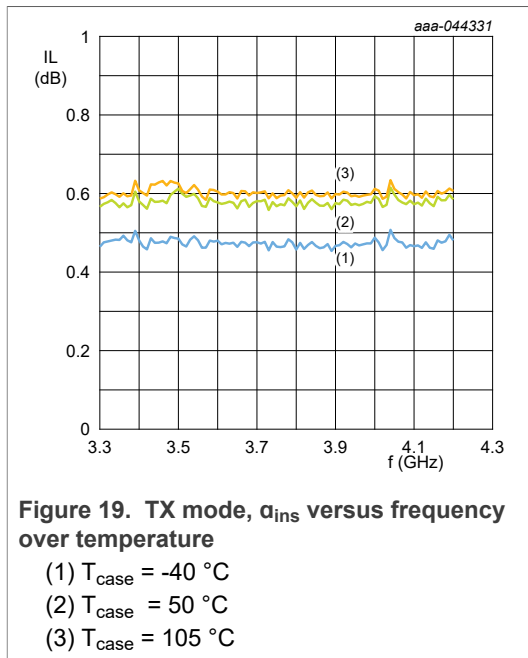

Figure 17. Low gain RX mode, $IP3_o$ versus frequency over temperature
 (1) $T_{case} = -40\text{ °C}$
 (2) $T_{case} = 50\text{ °C}$
 (3) $T_{case} = 105\text{ °C}$



14.4 TX mode



3.3 GHz - 4.2 GHz RX Analog Front-End Module with bypass

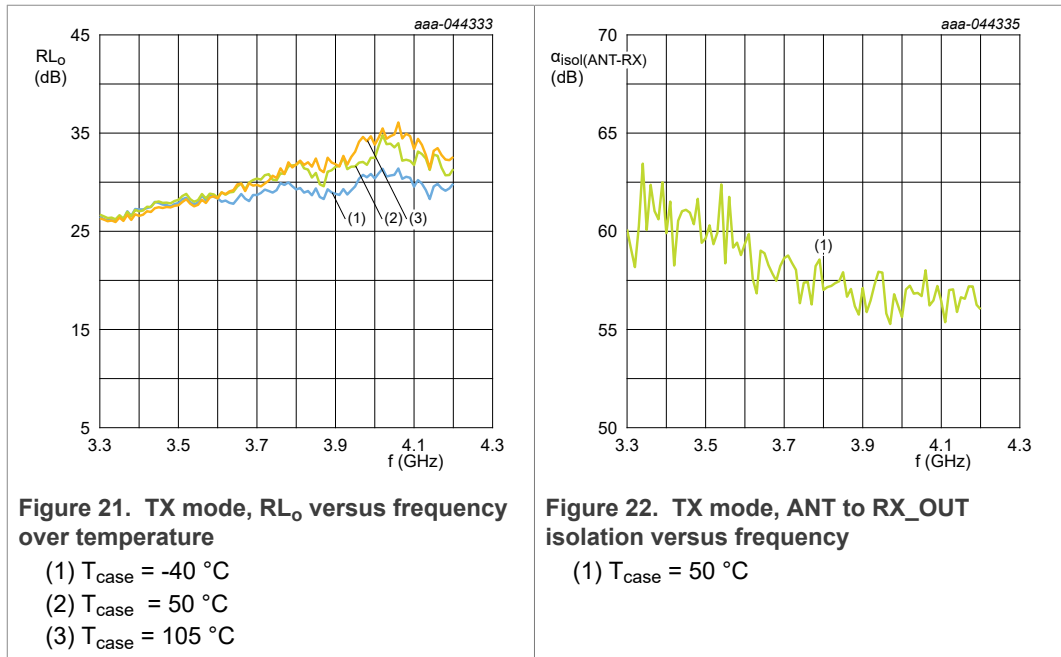

14.5 TX bypass mode

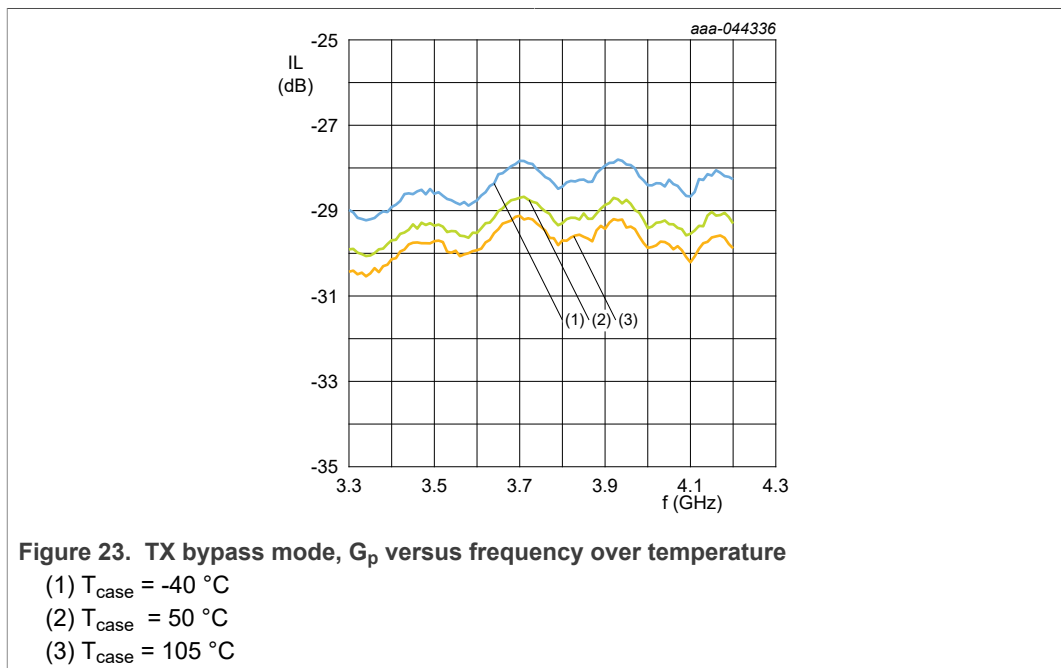

15 Application information

Table 11. Application schematic

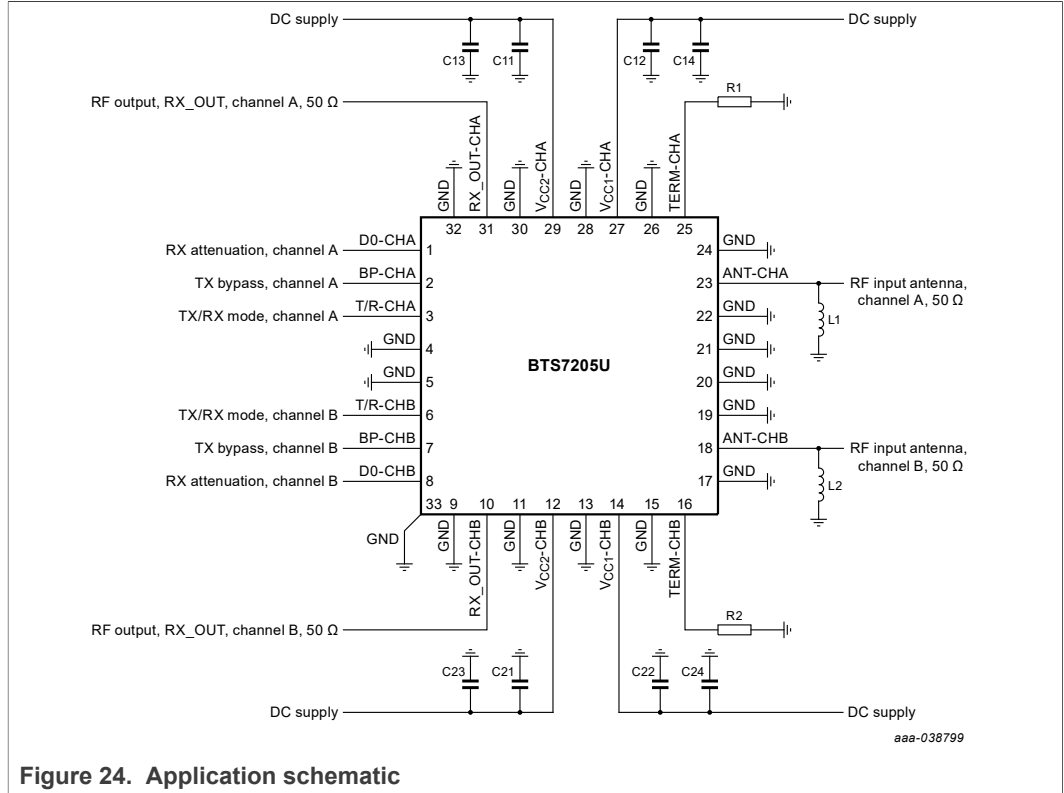

Figure 24. Application schematic

Table 12. List of components

Component	Description	Value	amount	Remarks
R1, and R2	load resistor	50 Ω, 50 W	2	must be able to withstand 34 dBm average power over lifetime
C11, C12, C21, and C22	capacitor	10 nF	4	as close as possible, less than 10 mm from IC
C13, C14, C23, and C24	capacitor	1 μF	4	as close as possible, less than 10 mm from IC
L1, and L2	inductor	120 nH	2	high-Q inductor, close to IC. Inductor is recommended to improve the switching time with a low ohmic connection at the ANT port.

16 Package outline

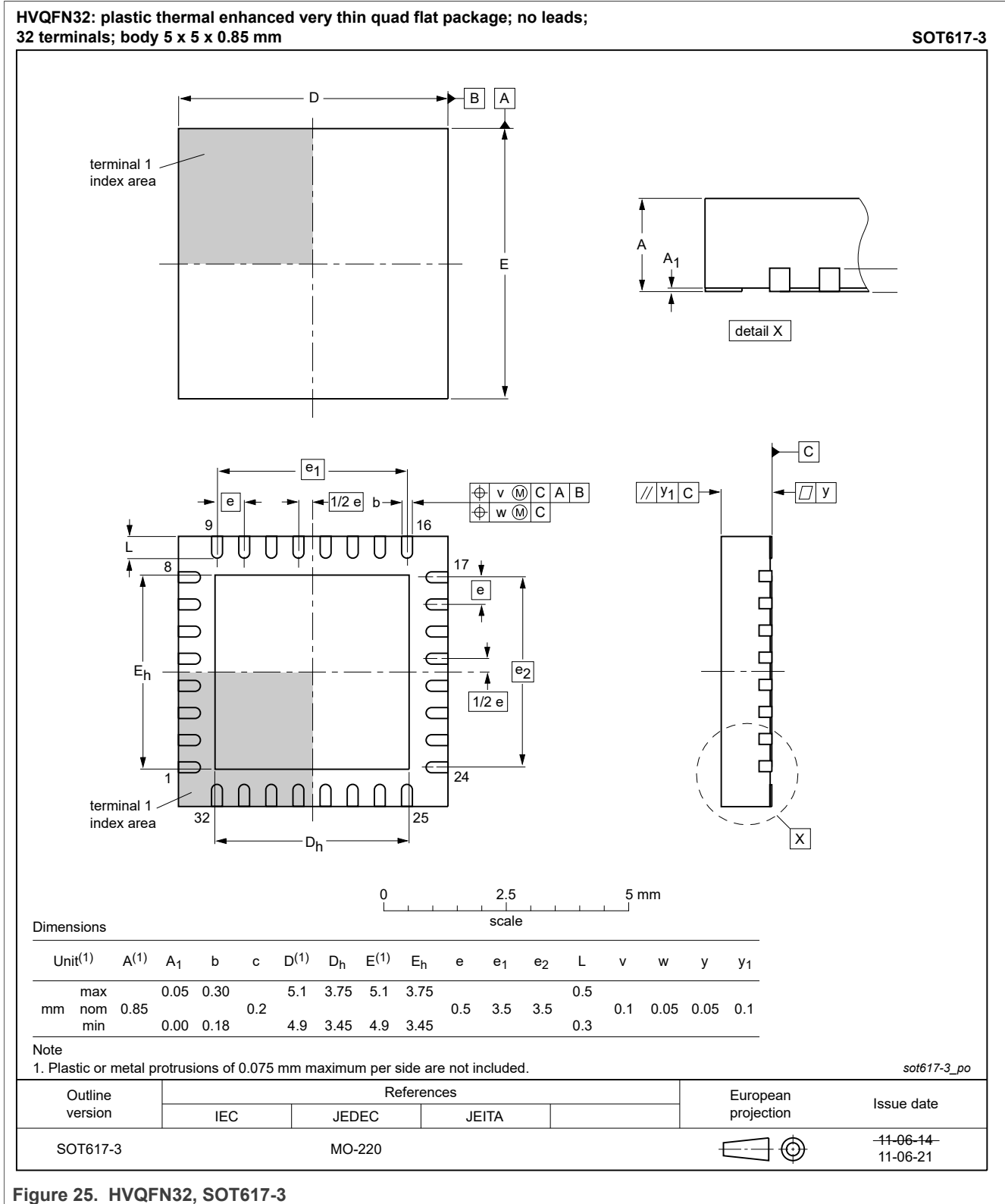

Figure 25. HVQFN32, SOT617-3

16.1 Footprint and solder information

NXP recommends by default to apply the soldering and footprint guidelines as are released in POD SOT617-3.

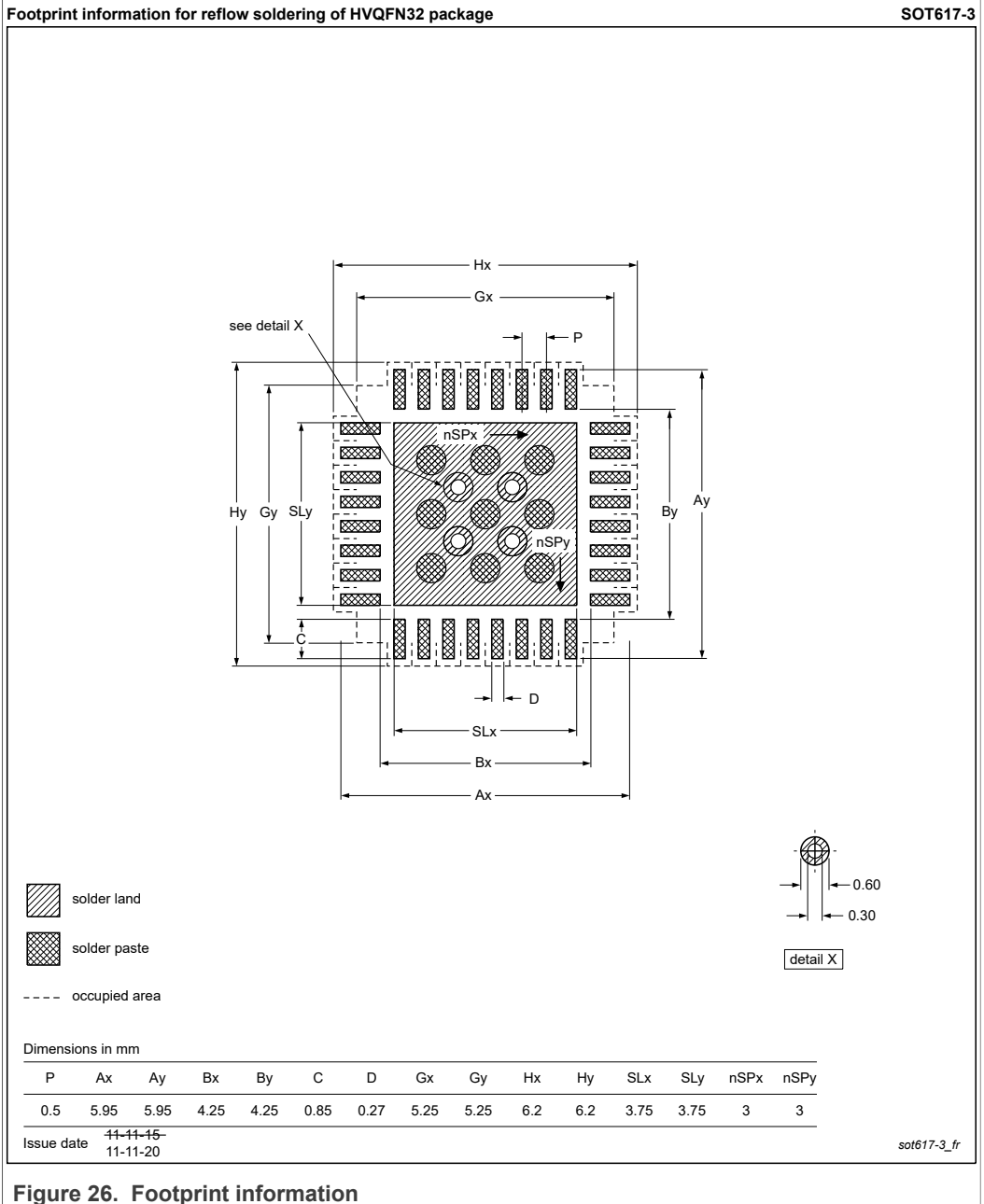

Figure 26. Footprint information

17 Handling information

CAUTION



This device is sensitive to ElectroStatic Discharge (ESD). Observe precautions for handling electrostatic sensitive devices. Such precautions are described in the *ANSI/ESD S20.20*, *IEC/ST 61340-5*, *JESD625-A* or equivalent standards.

18 Abbreviations

Table 13. Abbreviations

Acronym	Description
AMP	amplifier
ANT	antenna
BP	bypass
CPLR	coupler
CP-OFDM	cyclic prefix orthogonal frequency division multiplexing
D0	data line 0
ESD	electrostatic discharge
HVQFN	heat sink very thin quad flat no-leads
LNA	low noise amplifier
mMIMO	massive multiple-input multiple-output
PAPR	peak to average power ratio
QPSK	quadrature phase shift keying
SCS	sub carrier spacing
SPDT	single pull double throw
TERM	termination
T/R	transmit/receive mode

19 Revision history

Table 14. Revision history

Document ID	Release date	Data sheet status	Change notice	Supersedes
BTS7205U v.7	20220607	Product data sheet	202206005I	BTS7205U v.6
modification	<ul style="list-style-type: none"> corrected the Functional diagram 			
BTS7205U v.6	20211026	Product data sheet	-	BTS7205U v.5
modification	<ul style="list-style-type: none"> adapted some characteristic values added graphs changed status to Product data sheet added description on 120 nH coil 			
BTS7205U v.5	20211013	Objective data sheet	-	BTS7205U v.4

Table 14. Revision history...continued

Document ID	Release date	Data sheet status	Change notice	Supersedes
modification				
BTS7205U v.4	20210625	Objective data sheet	-	BTS7205U v.3
modification				
BTS7205U v.3	20210423	Objective data sheet	-	BTS7205U v.2.1
modification				
BTS7205U v.2.2	20210317	Objective data sheet	-	BTS7205U v.2.1
modification				
BTS7205U v.2.1	20210311	Objective data sheet	-	BTS7205U v.2
modification				
BTS7205U v.2	20200903	Objective data sheet	-	BTS7205U v.1
modification				
BTS7205U v.1	20200827	Objective data sheet	-	-

20 Legal information

20.1 Data sheet status

Document status ^{[1][2]}	Product status ^[3]	Definition
Objective [short] data sheet	Development	This document contains data from the objective specification for product development.
Preliminary [short] data sheet	Qualification	This document contains data from the preliminary specification.
Product [short] data sheet	Production	This document contains the product specification.

[1] Please consult the most recently issued document before initiating or completing a design.

[2] The term 'short data sheet' is explained in section "Definitions".

[3] The product status of device(s) described in this document may have changed since this document was published and may differ in case of multiple devices. The latest product status information is available on the Internet at URL <http://www.nxp.com>.

20.2 Definitions

Draft — A draft status on a document indicates that the content is still under internal review and subject to formal approval, which may result in modifications or additions. NXP Semiconductors does not give any representations or warranties as to the accuracy or completeness of information included in a draft version of a document and shall have no liability for the consequences of use of such information.

Short data sheet — A short data sheet is an extract from a full data sheet with the same product type number(s) and title. A short data sheet is intended for quick reference only and should not be relied upon to contain detailed and full information. For detailed and full information see the relevant full data sheet, which is available on request via the local NXP Semiconductors sales office. In case of any inconsistency or conflict with the short data sheet, the full data sheet shall prevail.

Product specification — The information and data provided in a Product data sheet shall define the specification of the product as agreed between NXP Semiconductors and its customer, unless NXP Semiconductors and customer have explicitly agreed otherwise in writing. In no event however, shall an agreement be valid in which the NXP Semiconductors product is deemed to offer functions and qualities beyond those described in the Product data sheet.

20.3 Disclaimers

Limited warranty and liability — Information in this document is believed to be accurate and reliable. However, NXP Semiconductors does not give any representations or warranties, expressed or implied, as to the accuracy or completeness of such information and shall have no liability for the consequences of use of such information. NXP Semiconductors takes no responsibility for the content in this document if provided by an information source outside of NXP Semiconductors.

In no event shall NXP Semiconductors be liable for any indirect, incidental, punitive, special or consequential damages (including - without limitation - lost profits, lost savings, business interruption, costs related to the removal or replacement of any products or rework charges) whether or not such damages are based on tort (including negligence), warranty, breach of contract or any other legal theory.

Notwithstanding any damages that customer might incur for any reason whatsoever, NXP Semiconductors' aggregate and cumulative liability towards customer for the products described herein shall be limited in accordance with the Terms and conditions of commercial sale of NXP Semiconductors.

Right to make changes — NXP Semiconductors reserves the right to make changes to information published in this document, including without limitation specifications and product descriptions, at any time and without notice. This document supersedes and replaces all information supplied prior to the publication hereof.

Suitability for use — NXP Semiconductors products are not designed, authorized or warranted to be suitable for use in life support, life-critical or safety-critical systems or equipment, nor in applications where failure or malfunction of an NXP Semiconductors product can reasonably be expected to result in personal injury, death or severe property or environmental damage. NXP Semiconductors and its suppliers accept no liability for inclusion and/or use of NXP Semiconductors products in such equipment or applications and therefore such inclusion and/or use is at the customer's own risk.

Applications — Applications that are described herein for any of these products are for illustrative purposes only. NXP Semiconductors makes no representation or warranty that such applications will be suitable for the specified use without further testing or modification.

Customers are responsible for the design and operation of their applications and products using NXP Semiconductors products, and NXP Semiconductors accepts no liability for any assistance with applications or customer product design. It is customer's sole responsibility to determine whether the NXP Semiconductors product is suitable and fit for the customer's applications and products planned, as well as for the planned application and use of customer's third party customer(s). Customers should provide appropriate design and operating safeguards to minimize the risks associated with their applications and products.

NXP Semiconductors does not accept any liability related to any default, damage, costs or problem which is based on any weakness or default in the customer's applications or products, or the application or use by customer's third party customer(s). Customer is responsible for doing all necessary testing for the customer's applications and products using NXP Semiconductors products in order to avoid a default of the applications and the products or of the application or use by customer's third party customer(s). NXP does not accept any liability in this respect.

Limiting values — Stress above one or more limiting values (as defined in the Absolute Maximum Ratings System of IEC 60134) will cause permanent damage to the device. Limiting values are stress ratings only and (proper) operation of the device at these or any other conditions above those given in the Recommended operating conditions section (if present) or the Characteristics sections of this document is not warranted. Constant or repeated exposure to limiting values will permanently and irreversibly affect the quality and reliability of the device.

Terms and conditions of commercial sale — NXP Semiconductors products are sold subject to the general terms and conditions of commercial sale, as published at <http://www.nxp.com/profile/terms>, unless otherwise agreed in a valid written individual agreement. In case an individual agreement is concluded only the terms and conditions of the respective agreement shall apply. NXP Semiconductors hereby expressly objects to applying the customer's general terms and conditions with regard to the purchase of NXP Semiconductors products by customer.

No offer to sell or license — Nothing in this document may be interpreted or construed as an offer to sell products that is open for acceptance or the grant, conveyance or implication of any license under any copyrights, patents or other industrial or intellectual property rights.

Quick reference data — The Quick reference data is an extract of the product data given in the Limiting values and Characteristics sections of this document, and as such is not complete, exhaustive or legally binding.

Export control — This document as well as the item(s) described herein may be subject to export control regulations. Export might require a prior authorization from competent authorities.

Suitability for use in non-automotive qualified products — Unless this data sheet expressly states that this specific NXP Semiconductors product is automotive qualified, the product is not suitable for automotive use. It is neither qualified nor tested in accordance with automotive testing or application requirements. NXP Semiconductors accepts no liability for inclusion and/or use of non-automotive qualified products in automotive equipment or applications.

In the event that customer uses the product for design-in and use in automotive applications to automotive specifications and standards, customer (a) shall use the product without NXP Semiconductors' warranty of the product for such automotive applications, use and specifications, and (b) whenever customer uses the product for automotive applications beyond NXP Semiconductors' specifications such use shall be solely at customer's own risk, and (c) customer fully indemnifies NXP Semiconductors for any liability, damages or failed product claims resulting from customer design and use of the product for automotive applications beyond NXP Semiconductors' standard warranty and NXP Semiconductors' product specifications.

Translations — A non-English (translated) version of a document, including the legal information in that document, is for reference only. The English version shall prevail in case of any discrepancy between the translated and English versions.

Security — Customer understands that all NXP products may be subject to unidentified vulnerabilities or may support established security standards or specifications with known limitations. Customer is responsible for the design and operation of its applications and products throughout their lifecycles to reduce the effect of these vulnerabilities on customer's applications and products. Customer's responsibility also extends to other open and/or proprietary technologies supported by NXP products for use in customer's applications. NXP accepts no liability for any vulnerability. Customer should regularly check security updates from NXP and follow up appropriately.

Customer shall select products with security features that best meet rules, regulations, and standards of the intended application and make the ultimate design decisions regarding its products and is solely responsible for compliance with all legal, regulatory, and security related requirements concerning its products, regardless of any information or support that may be provided by NXP.

NXP has a Product Security Incident Response Team (PSIRT) (reachable at PSIRT@nxp.com) that manages the investigation, reporting, and solution release to security vulnerabilities of NXP products.

20.4 Trademarks

Notice: All referenced brands, product names, service names, and trademarks are the property of their respective owners.

NXP — wordmark and logo are trademarks of NXP B.V.

Contents

1	General description	1
2	Features and benefits	1
3	Applications	1
4	Quick reference data	2
5	Ordering information	2
6	Marking	3
7	Functional diagram	3
8	Pinning information	4
8.1	Pin diagram	4
8.2	Pin description	4
9	Functional description	5
9.1	Modes of operation	5
10	Limiting values	6
11	Recommended operating conditions	6
12	Thermal characteristics	6
13	Characteristics	7
14	Graphs	9
14.1	All modes	9
14.2	High gain RX mode	9
14.3	Low gain RX mode	11
14.4	TX mode	13
14.5	TX bypass mode	14
15	Application information	15
16	Package outline	16
16.1	Footprint and solder information	17
17	Handling information	18
18	Abbreviations	18
19	Revision history	18
20	Legal information	20

Please be aware that important notices concerning this document and the product(s) described herein, have been included in section 'Legal information'.

© NXP B.V. 2022.

All rights reserved.

For more information, please visit: <http://www.nxp.com>

For sales office addresses, please send an email to: salesaddresses@nxp.com

Date of release: 7 June 2022