



ARCHIVED BY FREESCALE SEMICONDUCTOR, INC. 2005

125-1000 MHz Frequency Synthesizer

The MC12181 is a monolithic bipolar synthesizer integrating a high performance prescaler, programmable divider, phase/frequency detector, charge pump, and reference oscillator/buffer functions. The device is capable of synthesizing a signal which is 25 to 40 times the input reference signal. The device has a 4-bit parallel interface to set the proper total multiplication which can range from 25 to 40. When combined with an external passive loop filter and VCO, the MC12181 serves as a complete PLL subsystem.

- 2.7 to 5.5 V Operation
- Low power supply current of 4.25 mA typical
- On chip reference oscillator/buffer supporting wide frequency operating range from 5 to 25 MHz
- 4-bit parallel interface for programming divider (N = 25 40)
- Wide 125 – 1000 MHz frequency of operation
- Digital phase/frequency detector with linear transfer function
- Balanced Charge Pump Output
- Space efficient 16 lead SOIC package
- Operating Temperature Range of –40 to 85°C
- > 1000 V ESD Protection (I/O to Ground, I/O to V_{CC})

The device is suitable for applications where a fixed local oscillator (LO) needs to be synthesized or where a limited number of LO frequencies need to be generated. The device also has auxiliary open emitter outputs (Pout and Rout) for observing the inputs to the phase detector for verification purposes. In normal use the pins should be left open. The Reset input is normally LOW. When this input is placed in the HIGH state the reference prescaler is reset and the charge pump output (Do) is placed in the OFF state.

The 4-bit programming interface maps into divider states ranging from 25 to 40. A is the LSB and D is the MSB. The data inputs (A,B,C, and D) are CMOS compatible and have pull-up resistors. The inputs can be tied directly to V_{cc} or Ground for programming or can be interfaced to an external data latch/register. Table 1 below has a mapping of the programming states.

Table 1. Programming States

D	C	B	A	Divider
L	L	L	L	25
L	L	L	H	26
L	L	H	L	27
L	L	H	H	28
L	H	L	L	29
L	H	L	H	30
L	H	H	L	31
L	H	H	H	32
H	L	L	L	33
H	L	L	H	34
H	L	H	L	35
H	L	H	H	36
H	H	L	L	37
H	H	L	H	38
H	H	H	L	39
H	H	H	H	40

MC12181

125 – 1000 MHZ FREQUENCY SYNTHESIZER

SEMICONDUCTOR TECHNICAL DATA

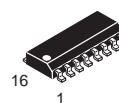

D SUFFIX
PLASTIC PACKAGE
CASE 751B
(SO-16)

PIN CONNECTIONS

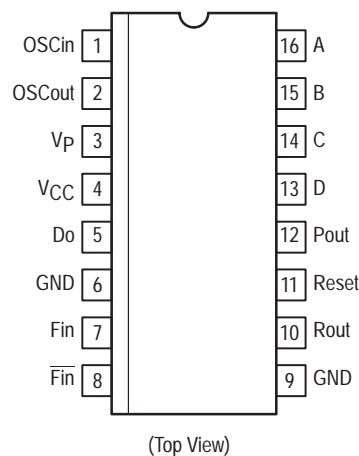

ORDERING INFORMATION

Device	Operating Temperature Range	Package
MC12181D	T _A = –40° to +85°C	SO-16

Figure 1. MC12181 Programmable Synthesizer

ARCHIVED BY FREESCALE SEMICONDUCTOR, INC. 2005

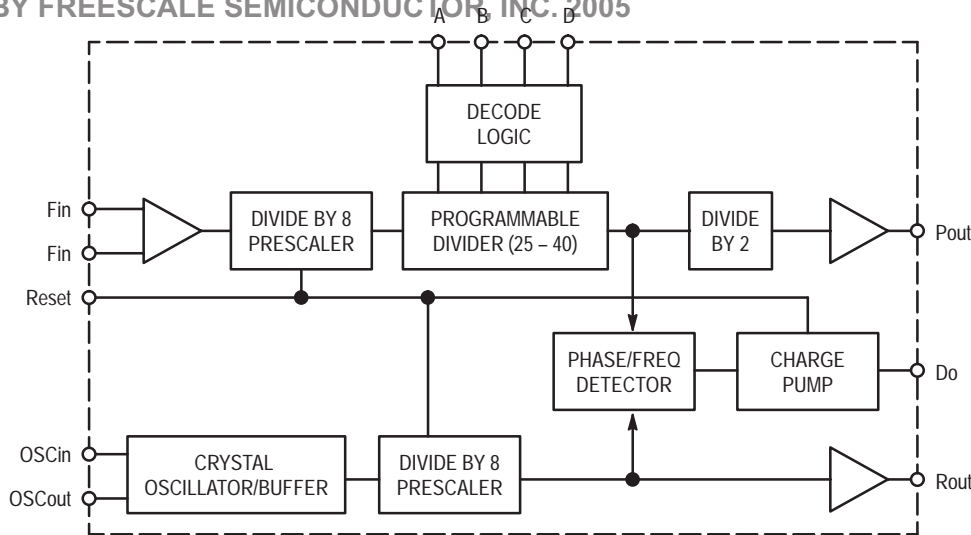

PIN NAMES

Pin No.	Pin	Function
1	OSCin	An external parallel resonant, fundamental crystal is connected between OSCin and OSCout to form an internal reference crystal oscillator. External capacitors C1 and C2 are required to set the proper crystal load capacitance and oscillator frequency (Figure 2). For an external reference oscillator, a signal is ac-coupled into the OSCin pin. In either mode a 50 kΩ resistor MUST be connected between OSCin and OSCout.
2	OSCout	Oscillator output, for use with an external crystal as shown in Figure 2.
3	V _P	Positive power supply for charge pump. V _P MUST be greater than or equal to V _{CC} . Bypassing should be placed as close as possible to this pin and be connected directly to the ground plane.
4	V _{CC}	Positive power supply. Bypassing should be placed as close as possible to this pin and be connected directly to the ground plane.
5	Do	Single ended phase/frequency detector output. Three-state current sink/source output for use as a loop error signal when combined with an external low pass filter. The phase/frequency detector is characterized by a linear transfer function.
6	GND	Ground. This pin should be directly tied to the ground plane.
7	Fin	Prescaler input – The VCO signal is ac-coupled into the Fin Pin.
8	Fin	Complementary prescaler input – This pin should be capacitively coupled to ground.
9	GND	Ground. This pin should be directly tied to the ground plane.
10	Rout	Open emitter test point used to verify proper operation of the reference divider chain. In normal operation this pin should be left OPEN.
11	Reset	Test pin used to clear the prescalers (Reset = H). When the Reset is in the HIGH state, the charge pump output is disabled. The Reset input has an internal pulldown. In normal operation it can be left open or tied to ground.
12	Pout	Open emitter test point used to verify proper operation of the programmable divider chain. The output is a divide-by-2 version of the programmable input to the phase/frequency detector. In normal operation this pin should be left OPEN.
13	D	Digital control inputs for setting the value of the programmable divider. A is the LSB and D is the MSB. In normal operation these pins can be tied to V _{CC} and/or ground to program a fixed divide or they can be driven by a CMOS logic level when used in a programmable mode. There is an internal pull-up resistor to V _{CC} on each input.
14	C	
15	B	
16	A	

Figure 2. Typical Applications Example

ARCHIVED BY FREESCALE SEMICONDUCTOR, INC. 2005

R1 is 50 kΩ (Nominal)
C1/C2 depend on crystal selected

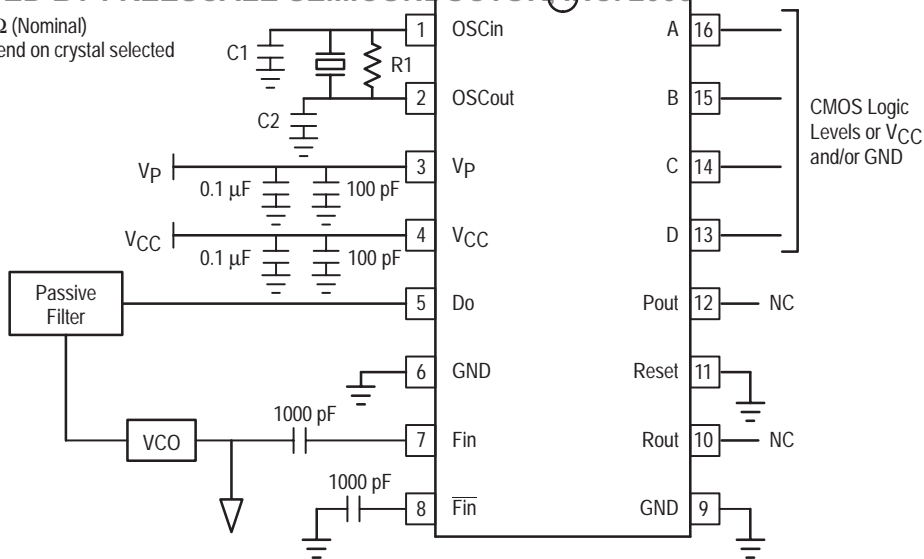
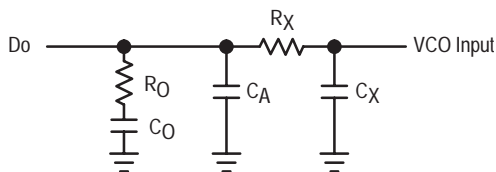

Figure 3. Typical Passive Loop Filter Topology



RECOMMENDED OPERATING CONDITIONS

Parameter	Symbol	Min	Max	Unit
Supply Range	VCC	2.7	5.5	VDC
Maximum Supply Range	VCCmax	-	-6.0	VDC
Maximum Charge Pump Voltage	Vpmax	-	VCC to +6.0	VDC
Temperature Ambient	TA	-40	85	°C
Storage Temperature	TSTG	-65	150	°C
Maximum Input Signal (Any Pin)	Vinmax	-	VCC+0.5 V	VDC

ELECTRICAL CHARACTERISTICS ($V_{CC} = 2.7$ to 5.5 V; $V_P = V_{CC}$ to 6.0 V; $T_A = -40$ to $+85^\circ\text{C}$, unless otherwise noted.)

Characteristic	Symbol	Min	Typ	Max	Unit	Condition
Supply Current for V_{CC}	I_{CC}	–	4.0	5.5	mA	Note 1
Supply Current for V_P	I_P	–	0.25	0.5	mA	Note 1
Input Frequency Range	OSCin	5	–	25	MHz	Note 2
RF Input Frequency Range	F_{in}	125	–	1000	MHz	Note 3
F_{in} Input Sensitivity	V_{in}	100	–	1000	mVpp	Note 4
OSCin Input Sensitivity	V_{OSC}	500	–	2200	mVpp	Note 4
Output Source Current (Do)	I_{OH}	–2.8	–2.2	–2.0	mA	Note 5
		–2.4	–2.0	–1.6		Note 6
Output Sink Current (Do)	I_{OL}	2.0	2.4	2.8	mA	Note 5
		1.6	2.0	2.4		Note 6
Output Leakage Current (Do)	I_{OZ}	–	0.5	10	nA	$V_{CC}=5.5$; $V_P = 6.0$ V; $V_{Do}=0.5$ to 5.5 V
Charge Pump Operating Volt	V_{Do}	0.5	–	$V_P-0.5$	V	
Input HIGH Voltage	Reset, A, B, C, D V_{IH}	$0.7 V_{CC}$	–	–	V	
Input LOW Voltage	Reset, A, B, C, D V_{IL}	–	–	$0.3 V_{CC}$	V	
Input HIGH Current	A, B, C, D I_{IH}	–	–	+1	μA	
	Reset	–	–	+100		
Input LOW Current	A, B, C, D I_{IL}	–100	–	–	μA	
	Reset	–1	–	+1		
Output Amplitude	(Pout, Rout) V_{out}	250	400	–	mVpp	Note 7

NOTES: 1. V_{CC} and $V_P = 5.5$ V; $F_{in} = 1.0$ GHz; OSCin = 25 MHz; Do open.

2. Assumes C_1 and C_2 (Figure 2) limited to ≤ 30 pF each including stray capacitance in crystal mode, ac coupled input for external reference mode.

3. AC coupling, F_{in} measured with a 1000pF capacitor.

4. Signal ac coupling in input.

5. $V_{CC} = 5.5$ V; $V_P = 6.0$ V; $V_{DO} = 3.0$ V.

6. $V_P = V_{CC} = 3.0$ V; $V_{DO} = 1.5$ V.

7. Minimum resistor value of 25 k Ω to ground.

The MC12181 is intended for applications where a fixed or a limited number of local oscillator frequencies is required to be synthesized. The device acts as a x25 – 40 PLL. The 4-bit parallel interface allows 1 of 16 divide ratios to be selected. Internally there are fixed divide by 8 prescalers in the reference and programmable paths of the PLL. The MC12181 operates from 125 MHz to 1000 MHz which makes the part ideal for FCC Title 47; Part 15 applications in the 260 MHz to 470 MHz band and the 902 to 928 MHz Band. Figure 4 shows a typical block diagram of the application.

Figure 4. Typical Block Diagram of Complete PLL

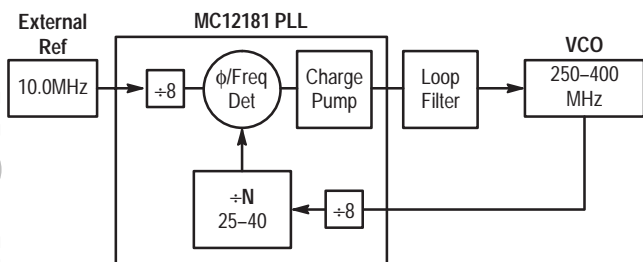

As can be seen from the block diagram, with the addition of a VCO, a loop filter, and either an external oscillator or crystal, a complete PLL sub-system can be realized. Since most of the PLL functions are integrated into the 12181, the users focus is on the loop filter design and the crystal reference oscillator circuit.

Crystal Oscillator Design

The PLL is used to transfer the high stability characteristic of a low frequency reference source to the high frequency VCO within the PLL loop. To facilitate this, the device contains an input circuit which can be configured as a crystal oscillator or a buffer for accepting an external signal source.

In the external reference mode, the reference source is ac-coupling into the OSCin input pin. The level of this signal should be between 500 – 2200 mVp-p. An external low noise reference should be used when it is desired to obtain the best close-in phase noise performance for the PLL. In addition the input reference amplitude should be close to the upper amplitude specification. This maximizes the slew rate of the input signal as it switches against the internal voltage reference.

In the crystal mode, an external parallel-resonant fundamental mode crystal should be connected between the OSCin and OSCout pins. This crystal must be between 5 and 25 MHz. External capacitors C1 and C2, as shown in Figure 2, are required to set the proper crystal load capacitance and oscillator frequency. The values of the capacitors are dependent on the crystal chosen and the input capacitance of the device as well as stray board capacitance.

Since the MC12181 is realized with an all-bipolar ECL style design, the internal oscillator circuitry is different from more traditional CMOS oscillator designs which realize the crystal oscillator with a modified inverter topology. These CMOS designs typically excite the crystal with a rail-to-rail signal which may overdrive the crystal resulting in damage or unstable operation. The MC12181 design does not exhibit this phenomena because the swing out of the OSCout pin is less than 600 mVp-p. This has the added advantage of

minimizing EMI and switching noise which can be generated by rail-to-rail CMOS outputs. The OSCout output should not be used to drive other circuitry.

The oscillator buffer in the MC12181 is a single stage, high speed, differential input/output amplifier; it may be considered to be a form of the Pierce oscillator. A simplified circuit diagram is seen in Figure 5.

Figure 5. Simplified Crystal Oscillator/Buffer Circuit

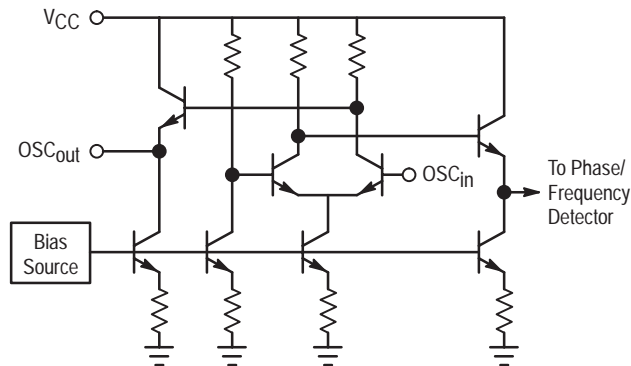

OSCin drives the base of one input of an NPN transistor differential pair. The non-inverting input of the differential pair is internally biased. OSCout is the inverted input signal and is buffered by an emitter follower with a 70 μA pull-down current and has a voltage swing of about 600mVp-p. Open loop output impedance is approximately 425 Ω. The opposite side of the differential amplifier output is used internally to drive another buffer stage which drives the phase/frequency detector. With the 50 kΩ feedback resistor in place, OSCin and OSCout are biased to approximately 1.1 V below VCC. The amplifier has a voltage gain of about 15dB and a bandwidth in excess of 150 MHz. Adherence to good RF design and layout techniques, including power supply pin decoupling, is strongly recommended.

A typical crystal oscillator application is shown in Figure 2. The crystal and the feedback resistor are connected directly between OSCin and OSCout, while the loading capacitors, C1 and C2, are connected between OSCin and ground, and OSCout and ground respectively. It is important to understand that as far as the crystal is concerned, the two loading capacitors are in series (albeit through ground). So when the crystal specification defines a specific loading capacitance, this refers to the total external (to the crystal) capacitance seen across its two pins.

This capacitance consists of the capacitance contributed by the amplifier (IC and packaging), layout capacitance, and the series combination of the two loading capacitors. This is illustrated in the equation below:

$$C_l = C_{AMP} + C_{STRAY} + \frac{C_1 \times C_2}{C_1 + C_2}$$

Provided the crystal and associated components are located immediately next to the IC, thus minimizing the stray capacitance, the combined value of C_{AMP} and C_{STRAY} is approximately 5pF. Note that the location of the OSCin and OSCout pins at the end of the package, facilitates placing the crystal, resistor and the C1 and C2 capacitors very close to the device. Usually, one of the capacitors is in parallel with an adjustable capacitor used to trim the frequency of oscillation.

It is important that the total external (to the IC) capacitance seen by either OSC_{in} or OSC_{out} , be no greater than 30pF.

In operation, the crystal oscillator will start up with the application of power. If the crystal is in a can that is not grounded it is often possible to monitor the frequency of oscillation by connecting an oscilloscope probe to the can; this technique minimizes any disturbance to the circuit. If this is not possible, a high impedance, low capacitance, FET probe can be connected to either OSC_{in} or OSC_{out} . Signals typically seen at those points will be very nearly sinusoidal with amplitudes of roughly 300–600mVp-p. Some distortion is inevitable and has little bearing on the accuracy of the signal going to the phase detector.

Loop Filter Design

Because the device is designed for a non-frequency agile synthesizer (i.e., how fast it tunes is not critical) the loop filter design is very straight forward. The current output of the charge pump allows the loop filter to be realized without the need of any active components. The preferred topology for the filter is illustrated in Figure 6.

Figure 6. Loop Filter

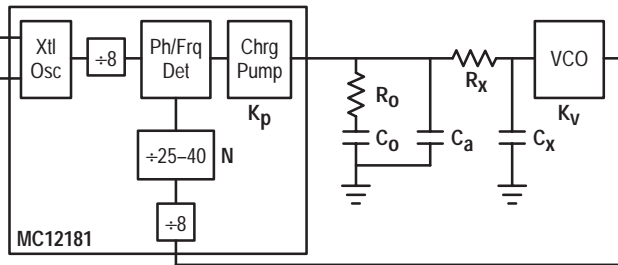

The R_0/C_0 components realize the primary loop filter. C_a is added to the loop filter to provide for reference sideband suppression. If additional suppression is needed, the R_x/C_x realizes an additional filter. In most applications, this will not be necessary. If all components are used, this results in a 4th order PLL, which makes analysis difficult. To simplify this, the loop design will be treated as a 2nd order loop (R_0/C_0) and additional guidelines are provided to minimize the influence of the other components. If more rigorous analysis is needed, mathematical/system simulation tools should be used.

Component	Guideline
C_a	$<0.1 \times C_0$
R_x	$>10 \times R_0$
C_x	$<0.1 \times C_0$

The focus of the design effort is to determine what the loop's natural frequency, ω_0 , should be. This is determined by R_0 , C_0 , K_p , K_v , and N_t . Because K_p , K_v , and N_t are given, it is only necessary to calculate values for R_0 and C_0 . There are 3 considerations in selecting the loop bandwidth:

- 1) Maximum loop bandwidth for minimum tuning speed

- 2) Optimum loop bandwidth for best phase noise performance
- 3) Minimum loop bandwidth for greatest reference sideband suppression

Usually a compromise is struck between these 3 cases, however, for a fixed frequency application, minimizing the tuning speed is not a critical parameter.

To specify the loop bandwidth for optimal phase noise performance, an understanding of the sources of phase noise in the system and the effect of the loop filter on them is required. There are 3 major sources of phase noise in the phase-locked loop – the crystal reference, the VCO, and the loop contribution. The loop filter acts as a low-pass filter to the crystal reference and the loop contribution. The loop filter acts as a high-pass filter to the VCO with an in-band gain equal to unity. The loop contribution includes the PLL IC, as well as noise in the system; supply noise, switching noise, etc. For this example, a loop contribution of 15dB has been selected, which corresponds to data in Figure 17.

The crystal reference and the VCO are characterized as high-order 1/f noise sources. Graphical analysis is used to determine the optimum loop bandwidth. It is necessary to have noise plots from the manufacturers of both devices. This method provides a straightforward approximation suitable for quickly estimating the optimal bandwidth. The loop contribution is characterized as white-noise or low-order 1/f noise given in the form of a noise factor which combines all the noise effects into a single value. The phase noise of the Crystal Reference is increased by the noise factor of the PLL IC and related circuitry. It is further increased by the total divide-by-N ratio of the loop. This is illustrated in Figure 7.

The point at which the VCO phase noise crosses the amplified phase noise of the Crystal Reference is the point of the optimum loop bandwidth. In the example of Figure 7, the optimum bandwidth is approximately 15 KHz.

Figure 7. Graphical Analysis of Optimum Bandwidth

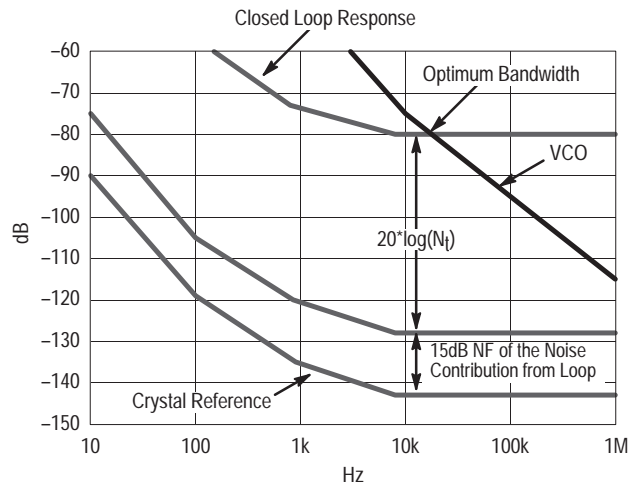

Freescale Semiconductor, Inc. ARCHIVE INFORMATION

ARCHIVE INFORMATION

Figure 8. Closed Loop Frequency Response for $\zeta = 1$

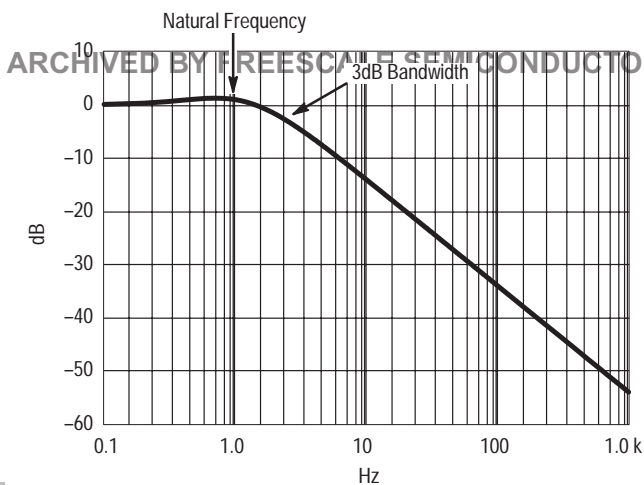

To simplify analysis further a damping factor of 1 will be selected. The normalized closed loop response is illustrated in Figure 8 where the loop bandwidth is 2.5 times the loop natural frequency (the loop natural frequency is the frequency at which the loop would oscillate if it were unstable). Therefore the optimum loop bandwidth is 15 kHz/2.5 or 6.0 kHz (37.7 krads) with a damping coefficient, $\zeta \approx 1$. T(s) is the transfer function of the loop filter.

$$T(s) = \frac{R_0 C_0 s + 1}{\left(\frac{N C_0}{K_p K_V}\right) s^2 + R_0 C_0 s + 1} = \frac{\left(\frac{2\zeta}{\omega_0}\right) s + 1}{\left(\frac{1}{\omega_0^2}\right) s^2 + \left(\frac{2\zeta}{\omega_0}\right) s + 1}$$

$$\left(\frac{N C_0}{K_p K_V}\right) = \left(\frac{1}{\omega_0^2}\right) \rightarrow \omega_0 = \sqrt{\frac{K_p K_V}{N C_0}} \rightarrow C_0 = \left(\frac{K_p K_V}{N \omega_0^2}\right)$$

$$R_0 C_0 = \left(\frac{2\zeta}{\omega_0}\right) \rightarrow \zeta = \left(\frac{\omega_0 R_0 C_0}{2}\right) \rightarrow R_0 = \left(\frac{2\zeta}{\omega_0 C_0}\right)$$

where N_t = Total PLL Divide Ratio — $8 \times N$ where ($N = 25 \dots 40$)
 K_V = VCO Gain — Hz/V
 K_p = Phase Detector/Charge Pump Gain — A
 $= (|I_{OH}| + |I_{OL}|) / 2$

Technically, K_V and K_p should be expressed in Radian units [K_V (RAD/V), K_p (A/RAD)]. Since the component design equation contains the $K_V \times K_p$ term, the 2π cancels and the values can be expressed as above.

Figure 9. Design Equations for the 2nd Order System

In summary, follow the steps given below:

- Step 1: Plot the phase noise of crystal reference and the VCO on the same graph.
- Step 2: Increase the phase noise of the crystal reference by the noise contribution of the loop.
- Step 3: Convert the divide-by-N to dB ($20 \log 8 \times N$) and increase the phase noise of the crystal reference by that amount.
- Step 4: The point at which the VCO phase noise crosses the amplified phase noise of the Crystal Reference is the point of the optimum loop bandwidth. This is approximately 15 kHz in Figure 7.
- Step 5: Correlate this loop bandwidth to the loop natural frequency per Figure 8. In this case the 3.0 dB bandwidth for a damping coefficient of 1 is 2.5 times the loop's natural frequency. The relationship between the 3.0 dB loop bandwidth and the loop's "natural" frequency will vary for different values of ζ . Making use of the equations defined in Figure 9, a math tool or spread sheet is useful to select the values for R_0 and C_0 .

Appendix: Derivation of Loop Filter Transfer Function

The purpose of the loop filter is to convert the current from the phase detector to a tuning voltage for the VCO. The total transfer function is derived in two steps. Step 1 is to find the voltage generated by the impedance of the loop filter. Step 2 is to find the transfer function from the input of the loop filter to its output. The "voltage" times the "transfer function" is the overall transfer function of the loop filter. To use these equations in determining the overall transfer function of a PLL multiply the filter's impedance by the gain constant of the phase detector then multiply that by the filter's transfer function (Figure 10 contains the transfer function equations for 2nd, 3rd and 4th order PLL filters.)

Freescale Semiconductor, Inc. ARCHIVE INFORMATION

ARCHIVE INFORMATION

Figure 10. Overall Transfer Function of the PLL

ARCHIVED BY FREESCALE SEMICONDUCTOR, INC. 2005

For the 2nd Order PLL:

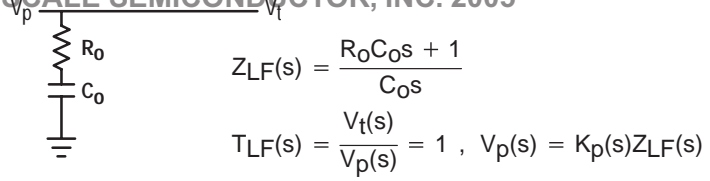

For the 3rd Order PLL:

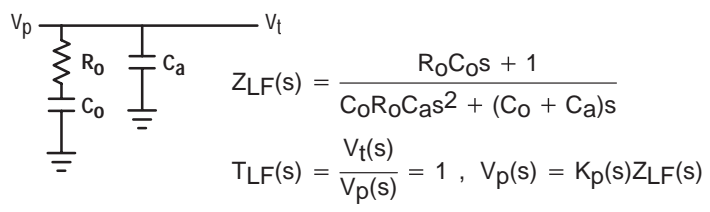

For the 4th Order PLL:

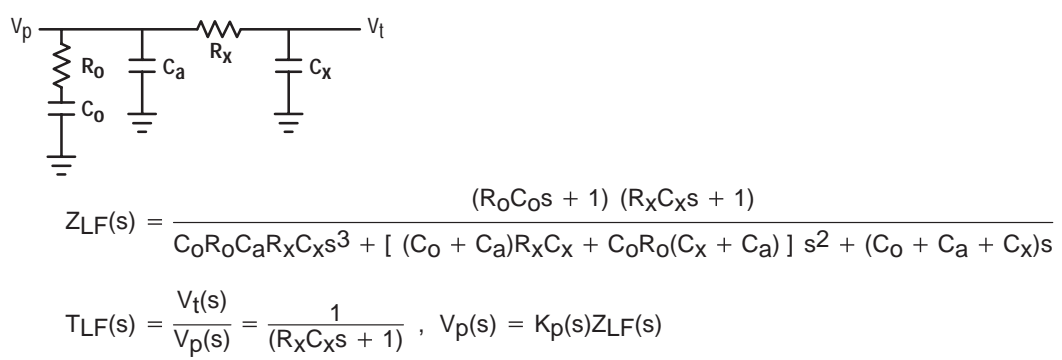
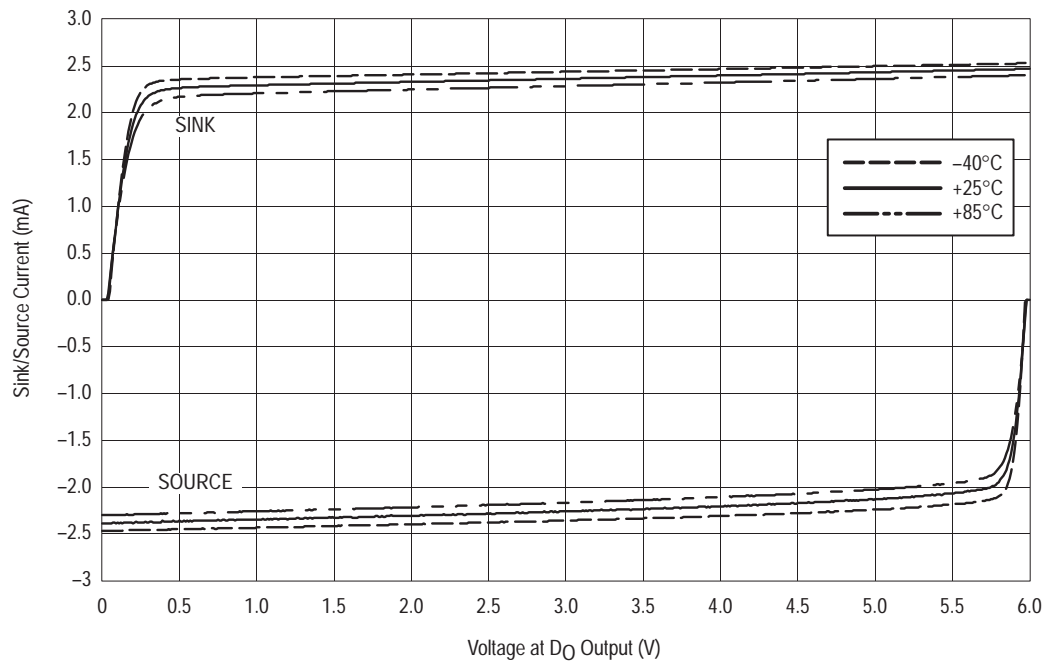

Figure 11. Typical Charge Pump Current versus Temperature
(VCC = 5.5 V; VP = 6.0 V)



Freescale Semiconductor, Inc. ARCHIVED BY FREESCALE SEMICONDUCTOR, INC. 2005

ARCHIVE INFORMATION



Figure 12. Typical Leakage Current at DO Over V_{DO} Range
(V_{CC} = 5.5 V; V_P = 6.0 V; T = 25°C)

ARCHIVED BY FREESCALE SEMICONDUCTOR, INC. 2005

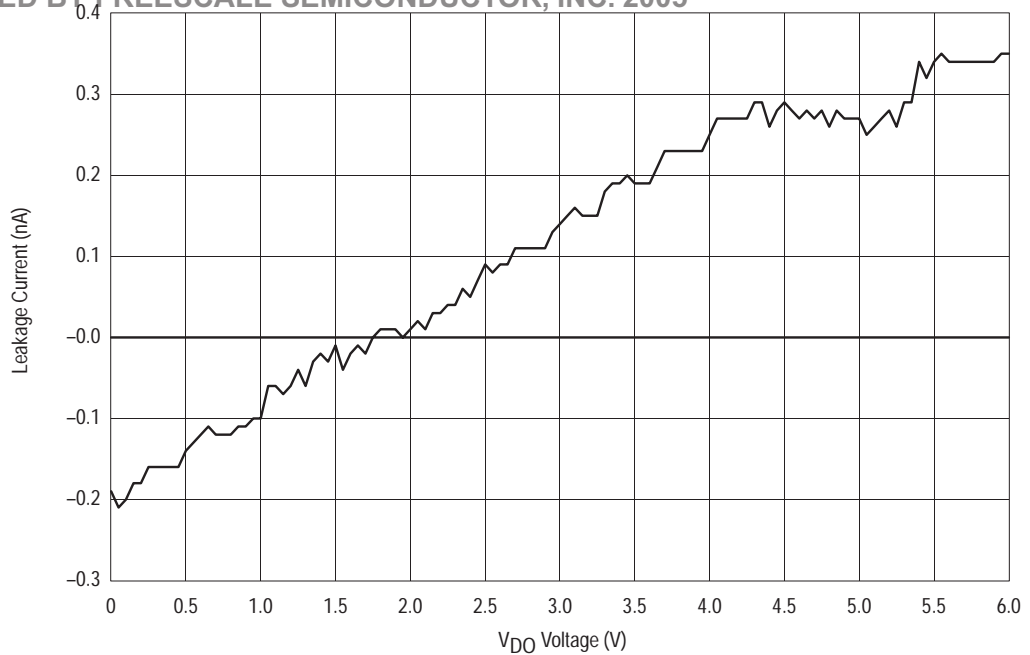
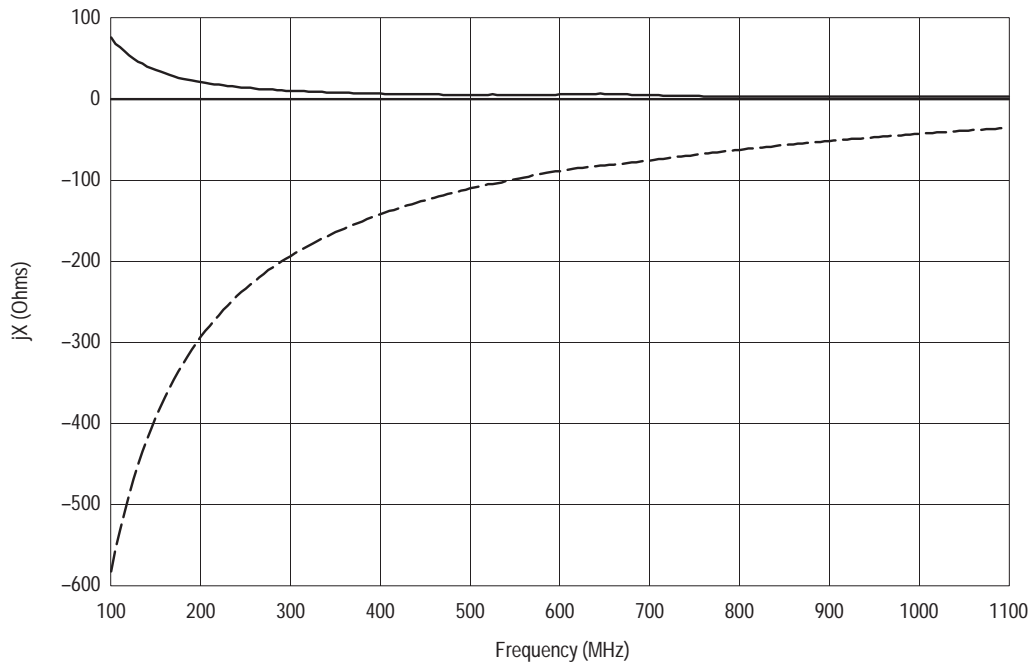

Figure 13. Typical F_{in} Input Impedance versus Input Frequency



Freescale Semiconductor, Inc. ARCHIVED BY FREESCALE SEMICONDUCTOR, INC. 2005

ARCHIVE INFORMATION



Figure 14. F_{in} Input Signal Sensitivity versus Input Frequency

ARCHIVED BY FREESCALE SEMICONDUCTOR, INC. 2005

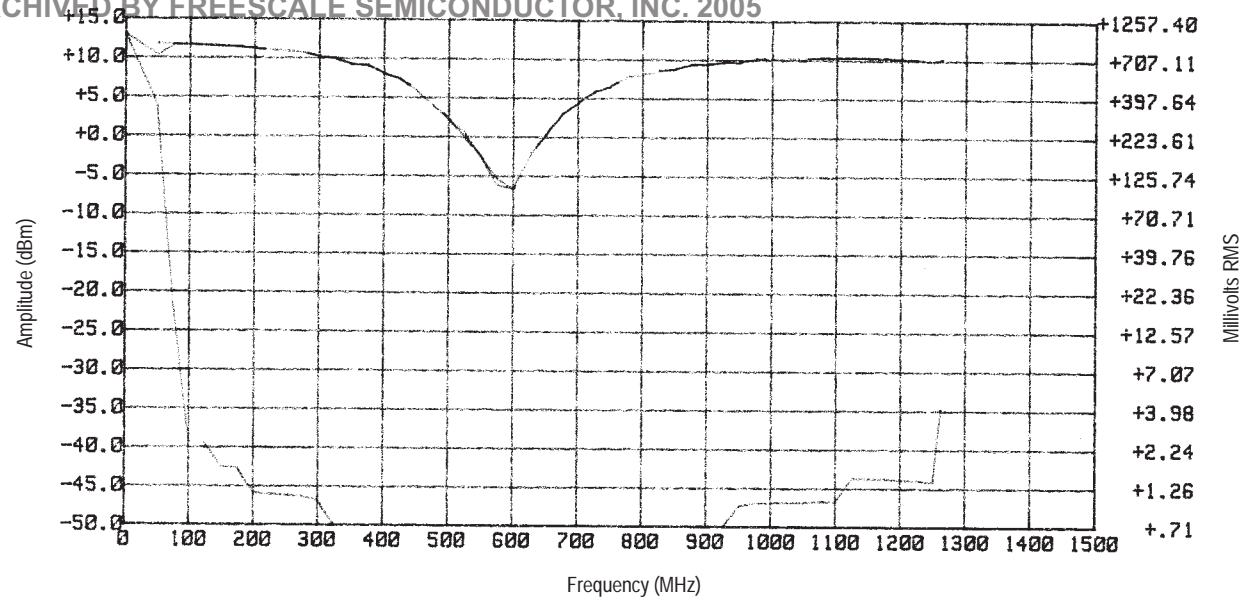
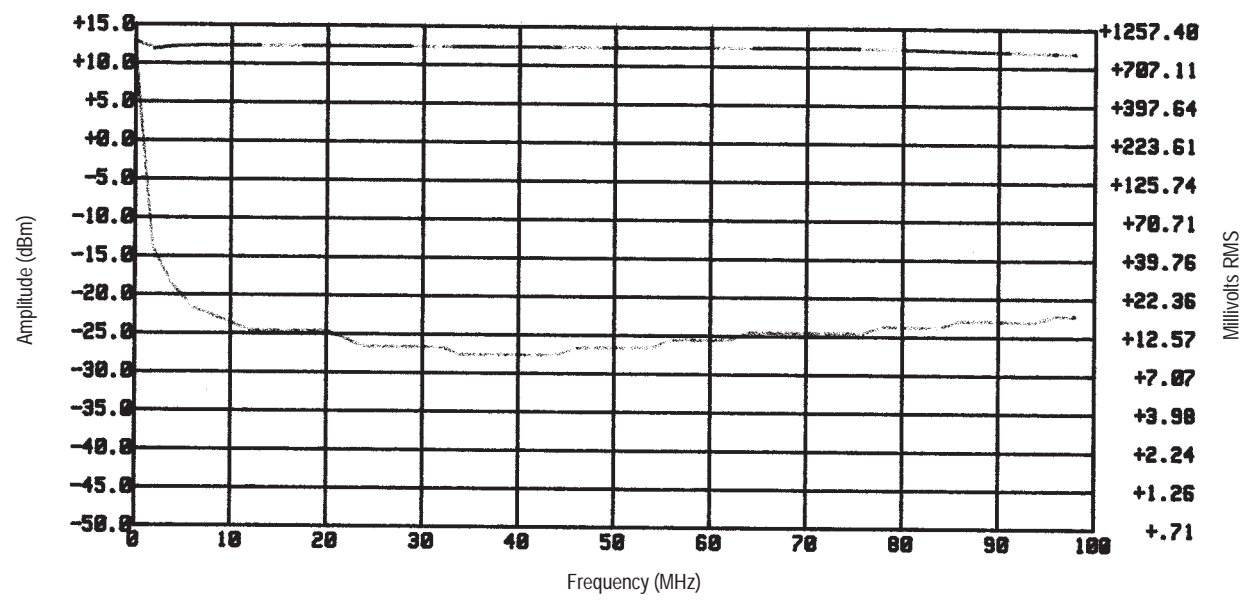

Figure 15. OSCin Input Sensitivity versus Input Frequency



Freescale Semiconductor, Inc. ARCHIVED BY FREESCALE SEMICONDUCTOR, INC. 2005

ARCHIVE INFORMATION



MC12181

Figure 16. VCO Output Spectrum
(P=30, 8.0 MHz ECLIPTEK Crystal)

ARCHIVED BY FREESCALE SEMICONDUCTOR, INC. 2005

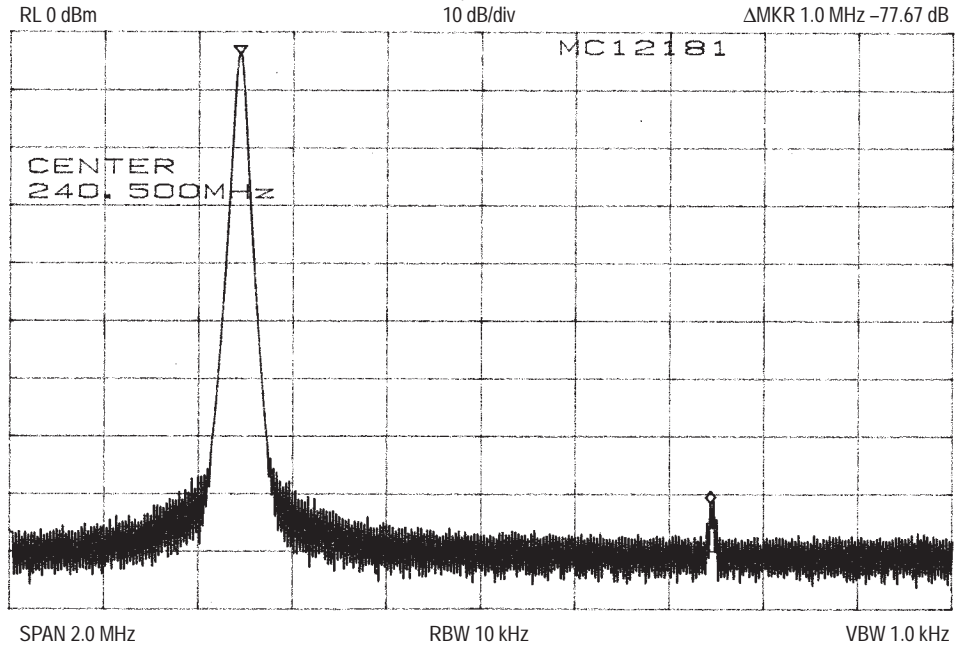
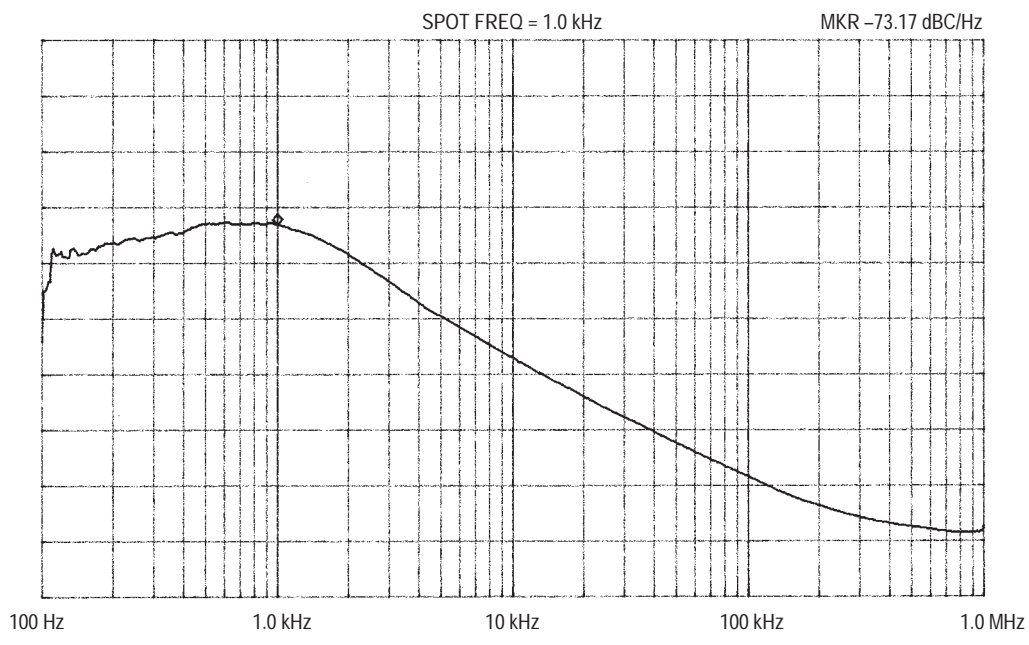

Figure 17. Typical Phase Noise Plot, 240MHz
(Low Noise 10 MHz Reference Input)



Freescale Semiconductor, Inc. ARCHIVED BY FREESCALE SEMICONDUCTOR, INC. 2005

ARCHIVE INFORMATION

OUTLINE DIMENSIONS

ARCHIVED BY FREESCALE SEMICONDUCTOR, INC. DSUFFIX. 2005

PLASTIC PACKAGE
CASE 751B-05
(SO-16)
ISSUE J

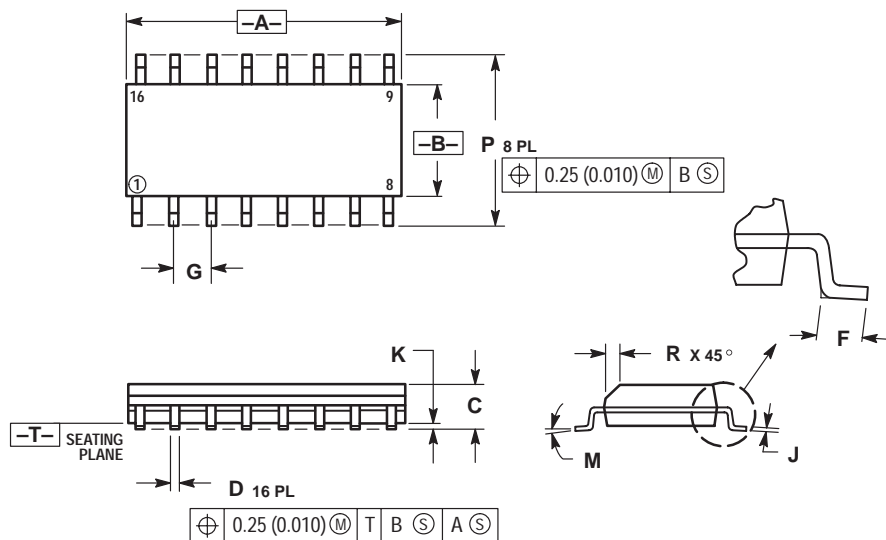

- NOTES:
1. DIMENSIONING AND TOLERANCING PER ANSI Y14.5M, 1982.
 2. CONTROLLING DIMENSION: MILLIMETER.
 3. DIMENSIONS A AND B DO NOT INCLUDE MOLD PROTRUSION.
 4. MAXIMUM MOLD PROTRUSION 0.15 (0.006) PER SIDE.
 5. DIMENSION D DOES NOT INCLUDE DAMBAR PROTRUSION. ALLOWABLE DAMBAR PROTRUSION SHALL BE 0.127 (0.005) TOTAL IN EXCESS OF THE D DIMENSION AT MAXIMUM MATERIAL CONDITION.

DIM	MILLIMETERS		INCHES	
	MIN	MAX	MIN	MAX
A	9.80	10.00	0.386	0.393
B	3.80	4.00	0.150	0.157
C	1.35	1.75	0.054	0.068
D	0.35	0.49	0.014	0.019
F	0.40	1.25	0.016	0.049
G	1.27 BSC		0.050 BSC	
J	0.19	0.25	0.008	0.009
K	0.10	0.25	0.004	0.009
M	0°	7°	0°	7°
P	5.80	6.20	0.229	0.244
R	0.25	0.50	0.010	0.019

Freescale Semiconductor, Inc.

ARCHIVE INFORMATION

ARCHIVE INFORMATION

Motorola reserves the right to make changes without further notice to any products herein. Motorola makes no warranty, representation or guarantee regarding the suitability of its products for any particular purpose, nor does Motorola assume any liability arising out of the application or use of any product or circuit, and specifically disclaims any and all liability, including without limitation consequential or incidental damages. "Typical" parameters which may be provided in Motorola data sheets and/or specifications can and do vary in different applications and actual performance may vary over time. All operating parameters, including "Typicals" must be validated for each customer application by customer's technical experts. Motorola does not convey any license under its patent rights nor the rights of others. Motorola products are not designed, intended, or authorized for use as components in systems intended for surgical implant into the body, or other applications intended to support or sustain life, or for any other application in which the failure of the Motorola product could create a situation where personal injury or death may occur. Should Buyer purchase or use Motorola products for any such unintended or unauthorized application, Buyer shall indemnify and hold Motorola and its officers, employees, subsidiaries, affiliates, and distributors harmless against all claims, costs, damages, and expenses, and reasonable attorney fees arising out of, directly or indirectly, any claim of personal injury or death associated with such unintended or unauthorized use, even if such claim alleges that Motorola was negligent regarding the design or manufacture of the part. Motorola and are registered trademarks of Motorola, Inc. Motorola, Inc. is an Equal Opportunity/Affirmative Action Employer.

Mfax is a trademark of Motorola, Inc.

How to reach us:

USA/EUROPE/Locations Not Listed: Motorola Literature Distribution;
P.O. Box 5405, Denver, Colorado 80217. 1-303-675-2140 or 1-800-441-2447

JAPAN: Motorola Japan Ltd.; SPD, Strategic Planning Office, 141,
4-32-1 Nishi-Gotanda, Shinagawa-ku, Tokyo, Japan. 81-3-5487-8488

Customer Focus Center: 1-800-521-6274

Mfax™: RMFAX0@email.sps.mot.com – TOUCHTONE 1-602-244-6609
Motorola Fax Back System – US & Canada ONLY 1-800-774-1848
– http://sps.motorola.com/mfax/

ASIA/PACIFIC: Motorola Semiconductors H.K. Ltd.; 8B Tai Ping Industrial Park,
51 Ting Kok Road, Tai Po, N.T., Hong Kong. 852-26629298

HOME PAGE: <http://motorola.com/sps/>



MOTOROLA

For More Information On This Product,
Go to: www.freescale.com