

Advance Information

 MMM5063/D
 Rev. 0.2, 09/2003

 Tri-Band GSM GPRS
 3.5 V Power Amplifier

MMM5063



(Scale 1:1)

Package Information

 Plastic Package
 Case 1383
 (Module, 7x7 mm)

Ordering Information

Device	Device Marking	Package
MMM5063	See Figure 25	Module

The MMM5063 is a tri-band single supply RF Power Amplifier for GSM900/DCS1800/PCS1900 GPRS handheld radios. This fully integrated Power Amplifier uses a patented concept to realize the 50 Ω matching on-chip through integration of passives on the GaAs die. This allows module functionality in a very small 7 x 7 mm package and achieves best-in-class Power Amplifier performance and multi-band capability.

Applications:

- Tri-Band GSM900 DCS1800 and PCS1900
- Guaranteed for 25% Duty Cycle

Features:

- Single Supply Enhancement Mode GaAs MESFET Technology
- Internal 50 Ω Input/Output Matching
- High Gain Three Stage Amplifier Design
- Typical 3.5 V Characteristics:
 - $P_{out} = 35.2$ dBm, PAE = 53% for GSM
 - $P_{out} = 33.8$ dBm, PAE = 44% for DCS
 - $P_{out} = 34$ dBm, PAE = 43% for PCS
- Optimized and Guaranteed for Open-Loop Power Control Applications
- Small 7 x 7 mm Package

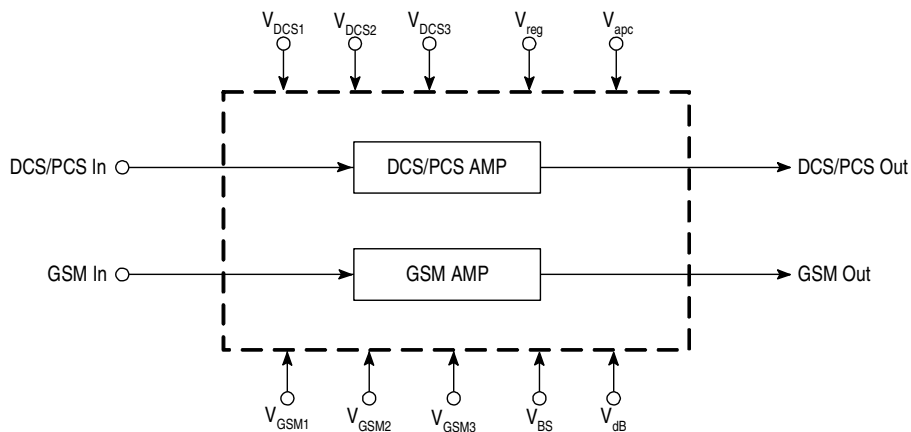

This device contains 26 active transistors.

Figure 1. Simplified Block Diagram

1 Electrical Specifications

Table 1. Maximum Ratings

Rating	Symbol	Value	Unit
Supply Voltage	$V_{GSM1,2,3}$, $V_{DCS1,2,3}$, V_{dB}	6.0	V
RF Input Power	GSM IN, DCS/PCS IN	11	dBm
RF Output Power GSM Section DCS/PCS Section	GSM OUT DCS/PCS OUT	38 36	dBm
Operating Case Temperature Range	T_C	-35 to 100	°C
Storage Temperature Range	T_{stg}	-55 to 150	°C
Die Temperature	T_J	150	°C

- NOTES:** 1. Maximum Ratings are those values beyond which damage to the device may occur. Functional operation should be restricted to the limits in the Electrical Characteristics or Recommended Operating Conditions tables.
 2. ESD (electrostatic discharge) immunity meets Human Body Model (HBM) ≤ 150 V and Machine Model (MM) ≤ 50 V. Additional ESD data available upon request.
 3. Meets Moisture Sensitivity Level (MSL) 3. See Figure 25 on page 17 for additional details.

Table 2. Recommended Operating Conditions

Characteristic	Symbol	Min	Typ	Max	Unit
Drain Supply Voltage	$V_{GSM1,2,3}$, $V_{DCS1,2,3}$	2.7	-	5.5	V
Bias Supply Voltage	V_{dB}	2.7	-	5.5	V
Regulated Voltage	V_{REG}	2.5	2.8	3.0	V
Power Control Voltage	V_{apc}	0	1.8	2.8	V
Band Select	V_{BS}	0	2.8	3.0	V
Input Power GSM	GSM IN	-1.0	-	8.0	dBm
Input Power DCS/PCS	DCS/PCS IN	2.0	-	10	dBm

Table 3. Control Requirements

Characteristic	Symbol	Min	Typ	Max	Unit
Current for V_{reg} @ 2.8 V	I_{reg}	-	7.7	10	mA
Band Select Low Band Enable Voltage High Band Enable Voltage	V_{BS}	2.2 0	2.8 -	- 0.3	V
Current for $V_{BS} = 2.8$ V	I_{BS}	-	0.76	1.0	mA

Table 4. Electrical Characteristics

 (Peak measurement at 25% duty cycle, 4.6 ms period, $T_A = 25^\circ\text{C}$, unless otherwise noted.)

Characteristic	Symbol	Min	Typ	Max	Unit
GSM 900 Section ($P_{in} = -1.0$ dBm, $V_{GSM1,2,3} = 3.5$ V pulsed, $V_{dB} = 3.5$ V, $V_{REG} = V_{BS} = 2.8$ V, $V_{ramp} = 1.8$ V pulsed)					
Frequency Range	BW	880	-	915	MHz
Output Power	P_{out}	34.2	35.2	-	dBm
Power Added Efficiency	PAE	48	53	-	%
Output Power @ Low Voltage ($V_{GSM1,2,3} = 2.8$ V pulsed, $V_{dB} = 2.8$ V)	P_{out}	32.5	33.4	-	dBm
Power Added Efficiency @ Low Voltage ($V_{GSM1,2,3} = 2.8$ V pulsed, $V_{dB} = 2.8$ V)	PAE	48	54	-	%
Harmonic Output					dBc
$2f_o$		-	-37	-33	
$\geq 3f_o$		-	-60	-45	

Table 4. Electrical Characteristics (Continued)

 (Peak measurement at 25% duty cycle, 4.6 ms period, $T_A = 25^\circ\text{C}$, unless otherwise noted.)

Characteristic	Symbol	Min	Typ	Max	Unit
Second Harmonic Leakage at DCS Output (Crosstalk isolation)		-	-28	-15	dBm
Input Return Loss	$ S_{11} $	-	10	-	dB
Output Power Isolation ($V_{\text{ramp}} = 0\text{ V}$, $V_{\text{GSM1,2,3}} = 0\text{ V}$)	P_{off}	-	-45	-40	dBm
Noise Power in Rx Band @ $P_{\text{in}} = -1.0\text{ dBm}$ (100 kHz measurement bandwidth) @ $f_o + 10\text{ MHz}$ ($f_o = 915\text{ MHz}$) @ $f_o + 20\text{ MHz}$ ($f_o = 915\text{ MHz}$)	NP	-	-80 -81	-	dBm
Noise Power in Rx Band @ $P_{\text{in}} = 6.0\text{ dBm}$ (100 kHz measurement bandwidth) @ $f_o + 10\text{ MHz}$ ($f_o = 915\text{ MHz}$) @ $f_o + 20\text{ MHz}$ ($f_o = 915\text{ MHz}$)	NP	-	-84 -86	-77 -81	dBm
Stability-Spurious Output ($P_{\text{out}} = 5.0\text{ to }35\text{ dBm}$, Load VSWR = 6:1 all Phase Angles, Adjust V_{ramp} for specified power)	P_{spur}	-	-	-60	dBc
Load Mismatch Stress ($P_{\text{out}} = 5.0\text{ to }35\text{ dBm}$, Load VSWR = 10:1 all phase angles, 5 seconds, Adjust V_{ramp} for specified power)		No Degradation in Output Power Before and After Test			

DCS Section ($P_{\text{in}} = 2.0\text{ dBm}$, $V_{\text{DCS1,2,3}} = 3.5\text{ V}$ pulsed, $V_{\text{dB}} = 3.5\text{ V}$, $V_{\text{REG}} = 2.8\text{ V}$, $V_{\text{ramp}} = 1.8\text{ V}$ pulsed, $V_{\text{BS}} = 0\text{ V}$)

Frequency Range	BW	1710	-	1785	MHz
Output Power	P_{out}	32.5	33.8	-	dBm
Power Added Efficiency	PAE	38	44	-	%
Output Power @ Low Voltage ($V_{\text{DCS1,2,3}} = 2.8\text{ V}$ pulsed, $V_{\text{dB}} = 2.8\text{ V}$)	P_{out}	31	32	-	dBm
Power Added Efficiency @ Low Voltage ($V_{\text{DCS1,2,3}} = 2.8\text{ V}$ pulsed, $V_{\text{dB}} = 2.8\text{ V}$)	PAE	38	45	-	%
Harmonic Output $2f_o$ $\geq 3f_o$		-	-65 -50	-45 -45	dBc
Input Return Loss	$ S_{11} $	-	9.0	-	dB
Output Power Isolation ($V_{\text{ramp}} = 0\text{ V}$, $V_{\text{DCS1,2,3}} = 0\text{ V}$)	P_{off}	-	-40	-35	dBm
Noise Power in Rx Band @ $P_{\text{in}} = 2.0\text{ dBm}$ @ $f_o + 20\text{ MHz}$ ($f_o = 1785\text{ MHz}$) (100 kHz measurement bandwidth)	NP	-	-78	-75	dBm
Stability-Spurious Output ($P_{\text{out}} = 0\text{ to }33\text{ dBm}$, Load VSWR = 6:1 all Phase Angles, Adjust V_{ramp} for specified power)	P_{spur}	-	-	-60	dBc

Table 4. Electrical Characteristics (Continued)

 (Peak measurement at 25% duty cycle, 4.6 ms period, $T_A = 25^\circ\text{C}$, unless otherwise noted.)

Characteristic	Symbol	Min	Typ	Max	Unit
Load Mismatch Stress ($P_{\text{out}} = 0$ to 33 dBm, Load VSWR = 10:1 all phase angles, 5 seconds, Adjust V_{ramp} for specified power)		No Degradation in Output Power Before and After Test			
PCS Section ($P_{\text{in}} = 3.0$ dBm, $V_{\text{DCS1,2,3}} = 3.5$ V pulsed, $V_{\text{dB}} = 3.5$ V, $V_{\text{REG}} = 2.8$ V, $V_{\text{ramp}} = 1.8$ V pulsed, $V_{\text{BS}} = 0$ V)					
Frequency Range	BW	1850	-	1910	MHz
Output Power	P_{out}	32.5	34	-	dBm
Power Added Efficiency	PAE	37	43	-	%
Output Power @ Low Voltage ($V_{\text{DCS1,2,3}} = 2.8$ V pulsed, $V_{\text{dB}} = 2.8$ V)	P_{out}	31	32	-	dBm
Power Added Efficiency @ Low Voltage ($V_{\text{DCS1,2,3}} = 2.8$ V pulsed, $V_{\text{dB}} = 2.8$ V)	PAE	37	43	-	%
Harmonic Output $2f_o$ $\geq 3f_o$		- -	-65 -50	-45 -45	dBc
Input Return Loss	$ S_{11} $	-	5.0	-	dB
Output Power Isolation ($V_{\text{ramp}} = 0$ V, $V_{\text{DCS1,2,3}} = 0$ V)	P_{off}	-	-35	-32	dBm
Noise Power in Rx Band @ $P_{\text{in}} = 3.0$ dBm @ $f_o + 20$ MHz ($f_o = 1910$ MHz) (100 kHz measurement bandwidth)	NP	-	-78	-75	dBm
Stability-Spurious Output ($P_{\text{out}} = 0$ to 33 dBm, Load VSWR = 6:1 all Phase Angles, Adjust V_{ramp} for specified power)	P_{spur}	-	-	-60	dBc
Load Mismatch Stress ($P_{\text{out}} = 0$ to 33 dBm, Load VSWR = 10:1 all phase angles, 5 seconds, Adjust V_{ramp} for specified power)		No Degradation in Output Power Before and After Test			

2 Typical Performance Characteristics

2.1 GSM

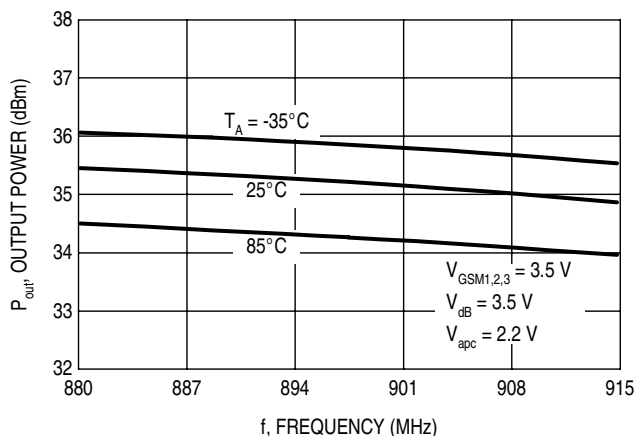

Figure 2. Output Power versus Frequency

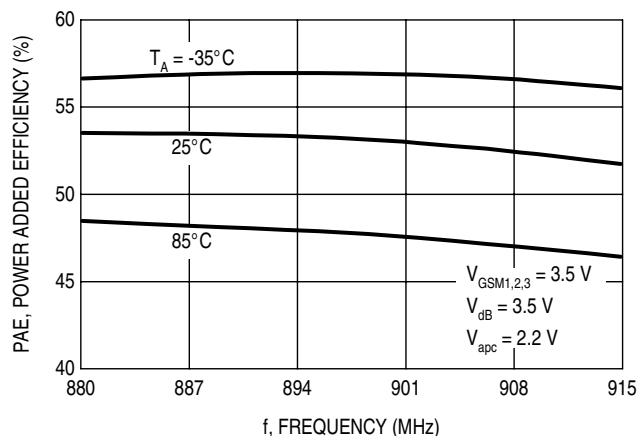

Figure 3. Power Added Efficiency versus Frequency

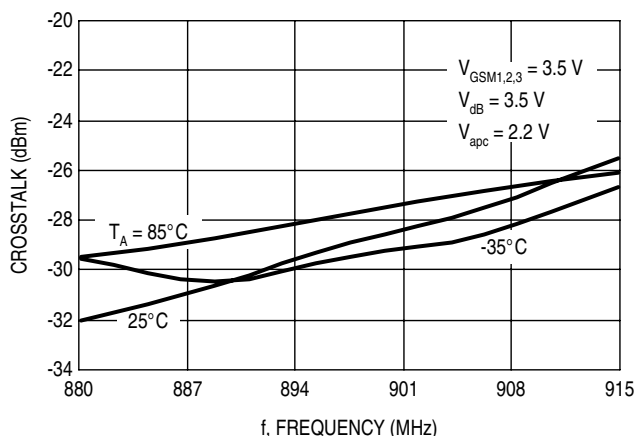

Figure 4. Crosstalk versus Frequency

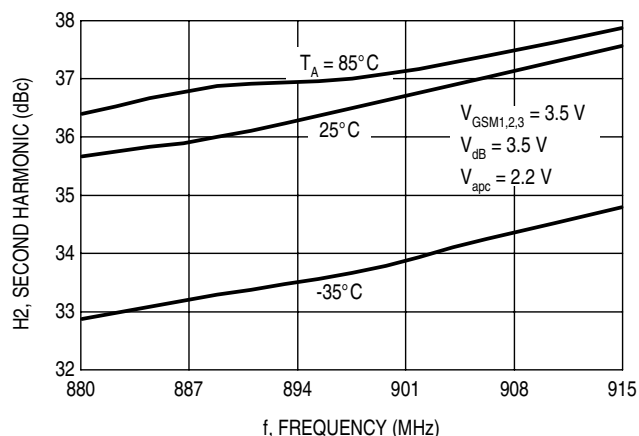

Figure 5. Second Harmonic Output versus Frequency

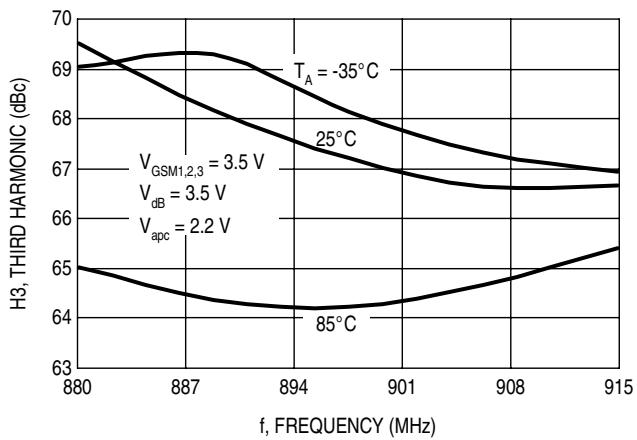

Figure 6. Third Harmonic Output versus Frequency

2.2 DCS

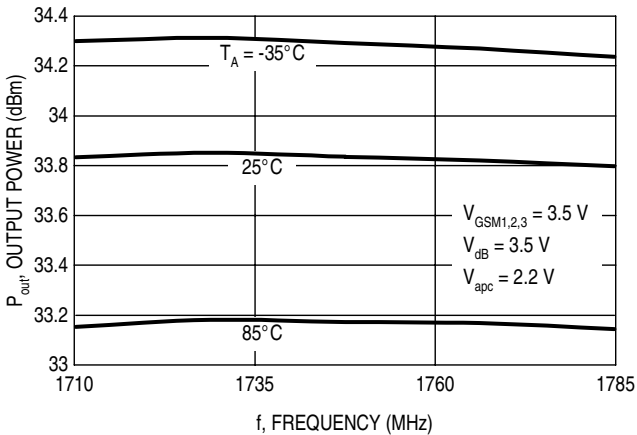

Figure 7. Output Power versus Frequency

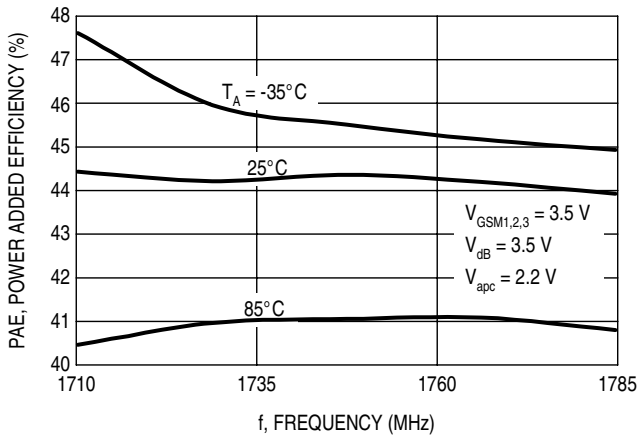

Figure 8. Power Added Efficiency versus Frequency

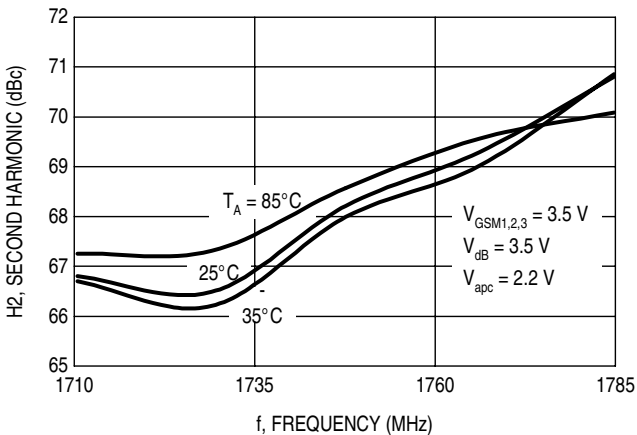

Figure 9. Second Harmonic Output versus Frequency

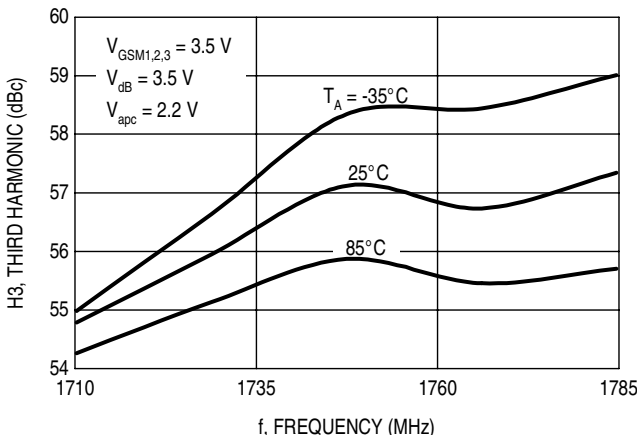

Figure 10. Third Harmonic Output versus Frequency

Freescale Semiconductor, Inc. ARCHIVED BY FREESCALE SEMICONDUCTOR, INC. 2005

2.3 PCS

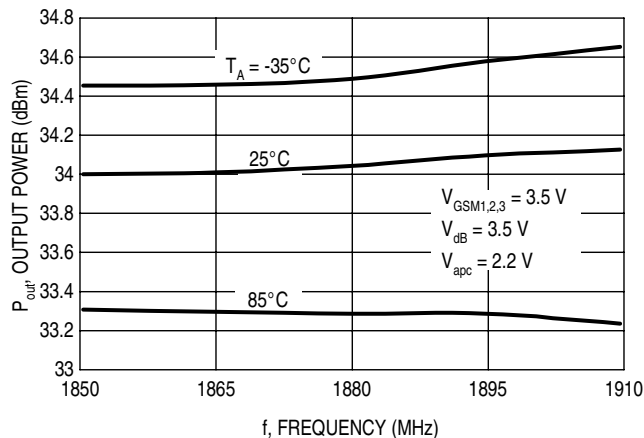

Figure 11. Output Power versus Frequency

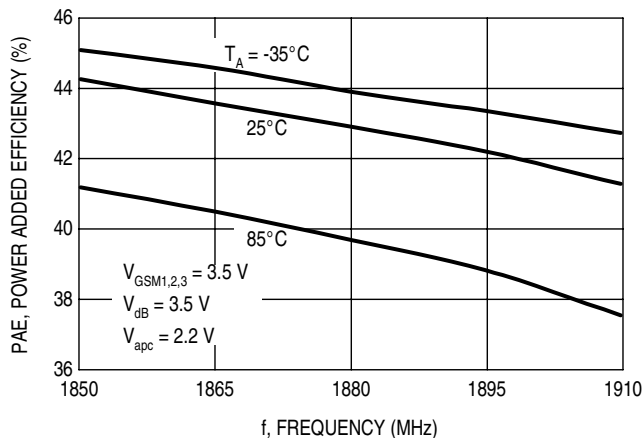

Figure 12. Power Added Efficiency versus Frequency

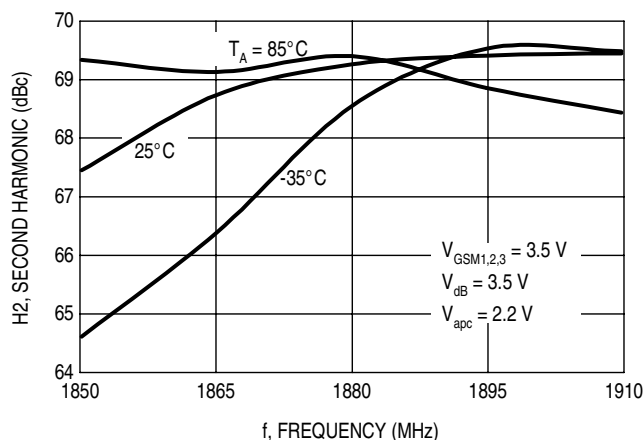

Figure 13. Second Harmonic Output versus Frequency

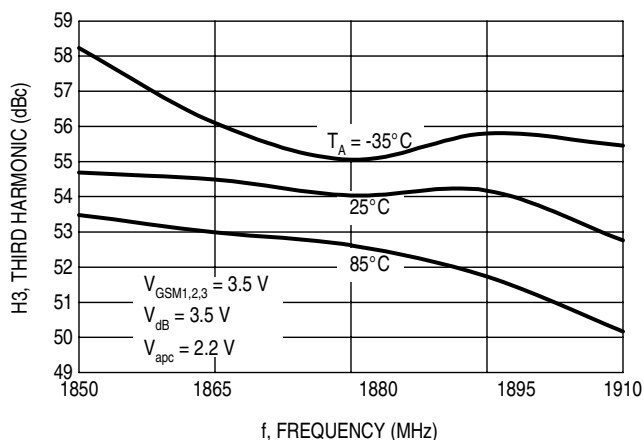
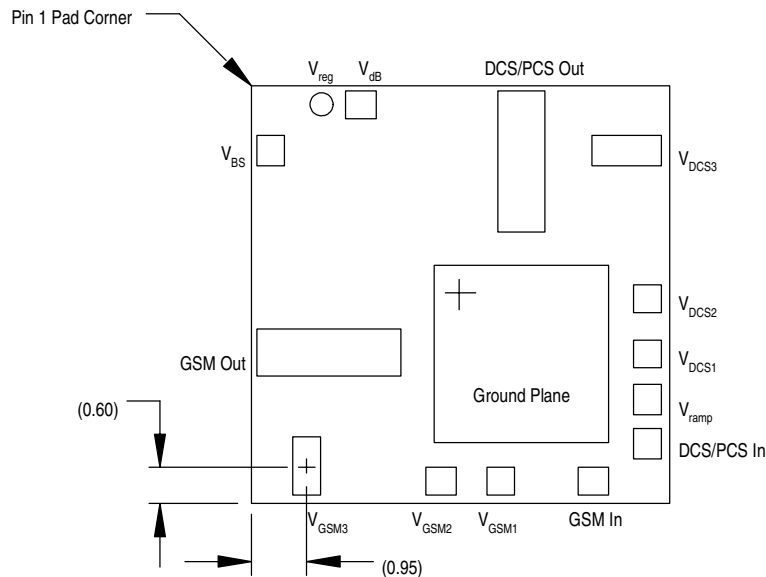

Figure 14. Third Harmonic Output versus Frequency

3 Contact Descriptions and Connections

Table 5. Contact Function Description

Pin	Symbol	Description
1	V_{reg}	Regulated dc voltage for bias circuit
2	V_{dB}	DC supply voltage for active bias circuits connected to the battery
3	DCS/PCS Out	DCS/PCS RF output
4	V_{DCS3}	DCS/PCS DC supply voltage for 3rd stage
5	V_{DCS2}	DCS/PCS DC supply voltage for 2nd stage
6	V_{DCS1}	DCS/PCS DC supply voltage for 1st stage
7	V_{apc}	Power control for both line-ups ($V_{apc} = 0\text{ V}$, $P_{out} = P_{off}$, $V_{apc} = 1.8\text{ V}$, $P_{out} = P_{max}$)
8	DCS/PCS In	DCS/PCS RF input
9	GSM In	GSM RF input
10	V_{GSM1}	GSM DC supply voltage for 1st stage
11	V_{GSM2}	GSM DC supply voltage for 2nd stage
12	V_{GSM3}	GSM DC supply voltage for 3rd stage
13	GSM Out	GSM RF output
14	V_{BS}	Band selection between GSM and DCS/PCS



NOTE: For optimum performance V_{GSM1} and V_{GSM2} , as well as V_{DCS1} and V_{DCS2} , must be strapped together on the application demobard.

Figure 15. Contact Connections
(Bottom View)

4 Application Information

4.1 Power Control Considerations

The MMM5063 is designed for open loop (drain control) applications. A PMOS FET is used to switch the MMM5063 drain and vary the supply voltage from 0 to the battery voltage setting (V_{bat}). The simplified concept schematic (see Figure 22) describes the application circuit used to control the device through the drain voltage.

A drain control provides a linear transfer function which is repeatable versus control voltage (see Figure 16).

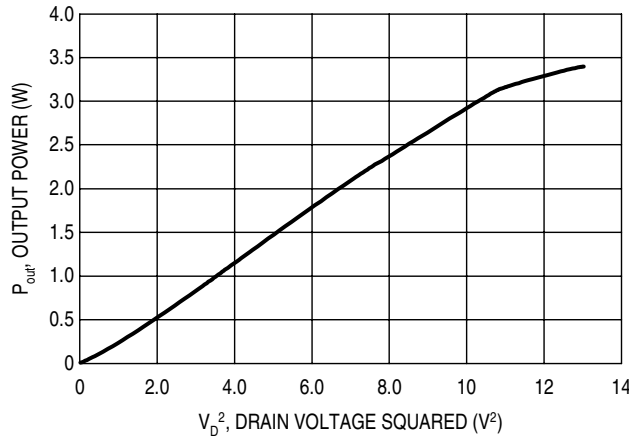

Figure 16. Output Power versus Drain Voltage

4.2 GSM Second Harmonic (H2) Trap Circuitry

When transmitting in GSM saturated mode, the second harmonic is naturally present at the RF output of the PA and reaches the antenna after additional filtering in the front-end. ETSI specifies that harmonic level cannot exceed -36 dBm. In order to improve H2 rejection in low Band (GSM), an H2 trap has been developed. The topology is based on a Low Pass π Cell Filter (see Figure 17) where the first shunt capacitor is actually part of the PA output match.

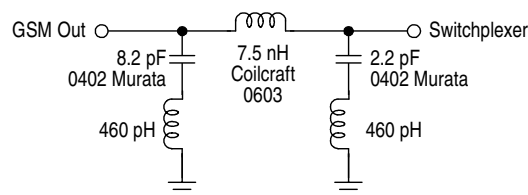
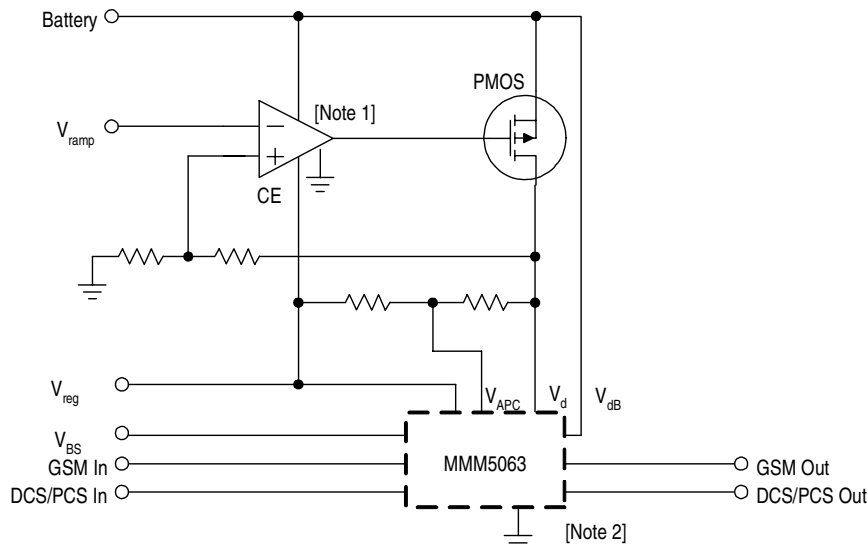

Figure 17. Low Pass Filter

This circuit reduces H2 level by 7 to 8 dB with low in-band insertion losses (mainly due to the series inductor). Moreover, this structure can be used to match Power amplifier module output to the switchplexer.

4.3 Application Schematics and Printed Circuit Boards



- NOTES:**
1. Op/Amp is either external (with an enable pin CE) or in an ASIC.
 2. The MMM5063 requires 4 to 6 RF/LF decoupling capacitors (not shown).

Figure 18. Open Loop Control Application Schematic

Figure 18 represents the complete Power Amplifier implementation including the MMM5063 Amplifier Module and the Control Circuitry. This functionality is realized with two separate printed circuit boards; the PA Evaluation Circuit with schematic shown in Figure 21 and PCB Layout shown in Figure 23, and the Power Amplifier Control Loop with schematic shown in Figure 22 and PCB Layout shown in Figure 24.

The PA Evaluation Circuit is straightforward and, due to the MMM5063's high level of integration, requires only a few passive components around the package. These components are mainly de-coupling capacitors.

The Power Amplifier Control Loop is based on an operational amplifier driving a PMOS transistor. The PMOS device functions as a linear drain voltage regulator controlled by V_{ramp} with a typical gain of 2 which is set through the resistive divider R4 and R5 as shown in Figure 22. To control output power through the drain, V_{apc} must be indexed to the drain voltage to prevent the PA Section from drawing excessive current especially at low output power. Nevertheless, V_{apc} should stay above 0.8 V to provide sufficient gain for the line-up. Figure 19 describes the application circuit used to control V_{apc} through the drain voltage. It uses V_{reg} to pre-position V_{apc} at 0.9 V and add a voltage which is dependent on the drain Voltage.

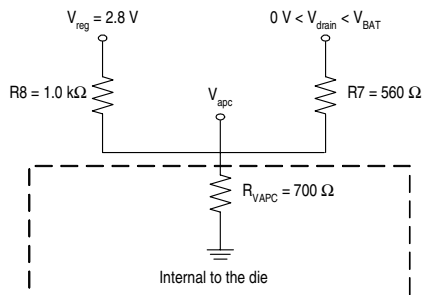

Figure 19.

R8 and $R_{V_{apc}}$ set V_{apc} at 0.9 V while R7 sets the V_{apc} slope. V_{apc} versus V_{drain} is shown in the Figure 20.

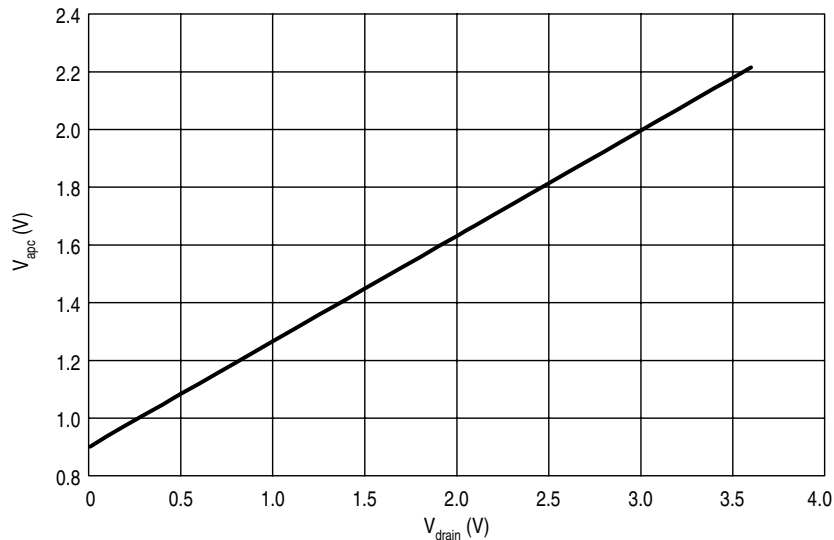

Figure 20. V_{apc} versus V_{drain}

It is possible that the Power Control DAC output voltage can be in the 200 mV to 2.0 V range. This raises a concern for the MMM5063 ramp control voltage (V_{ramp}) which must start at 0 V to get enough output power dynamic range. To overcome this limitation, a resistor (R6 in Figure 22) is used to set an additional offset (200 mV with $R6 = 39\text{ k}\Omega$). This residual voltage is then subtracted the DAC output voltage through the differential Operational Amplifier.

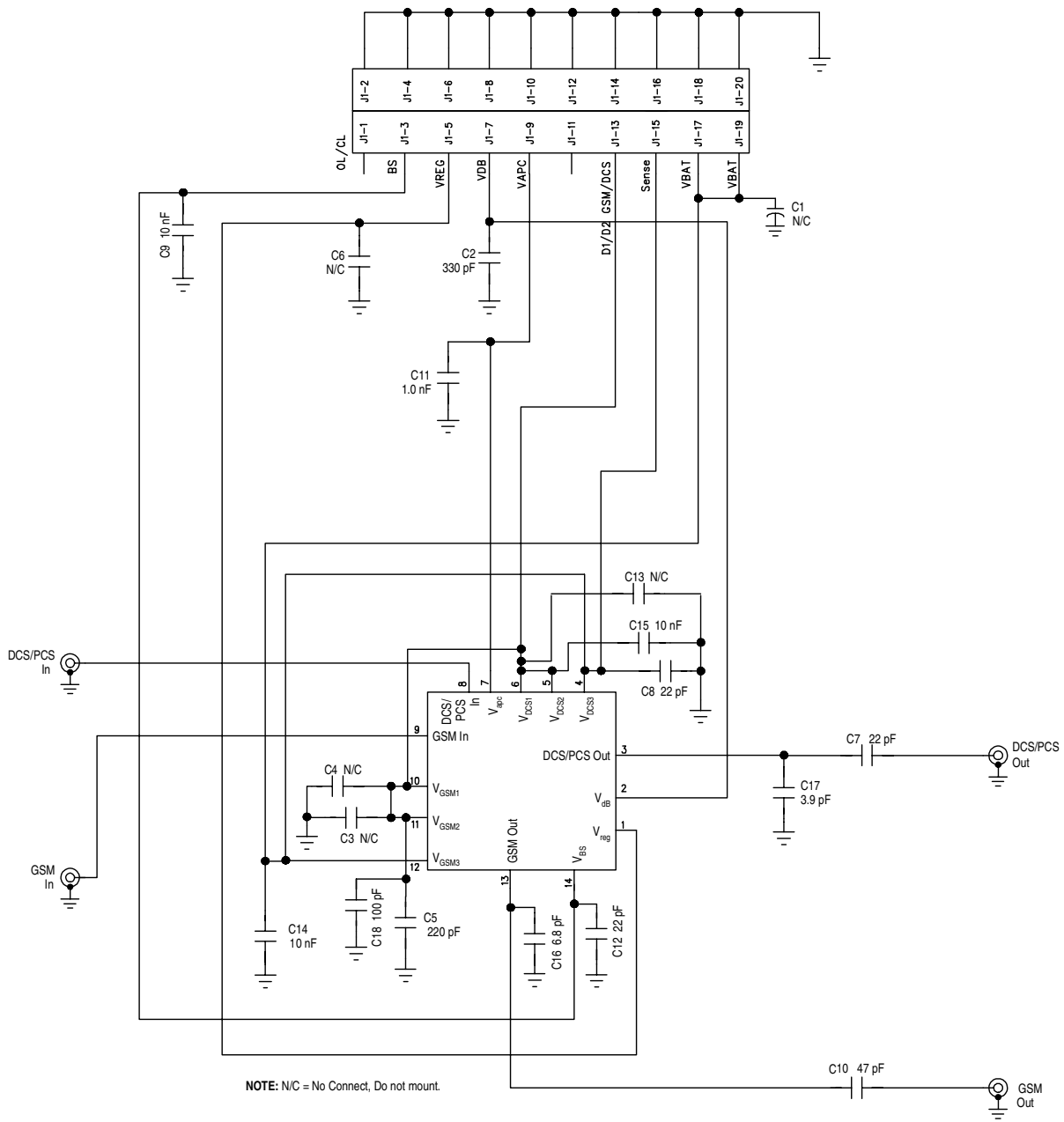

Figure 21. PA Evaluation Circuit

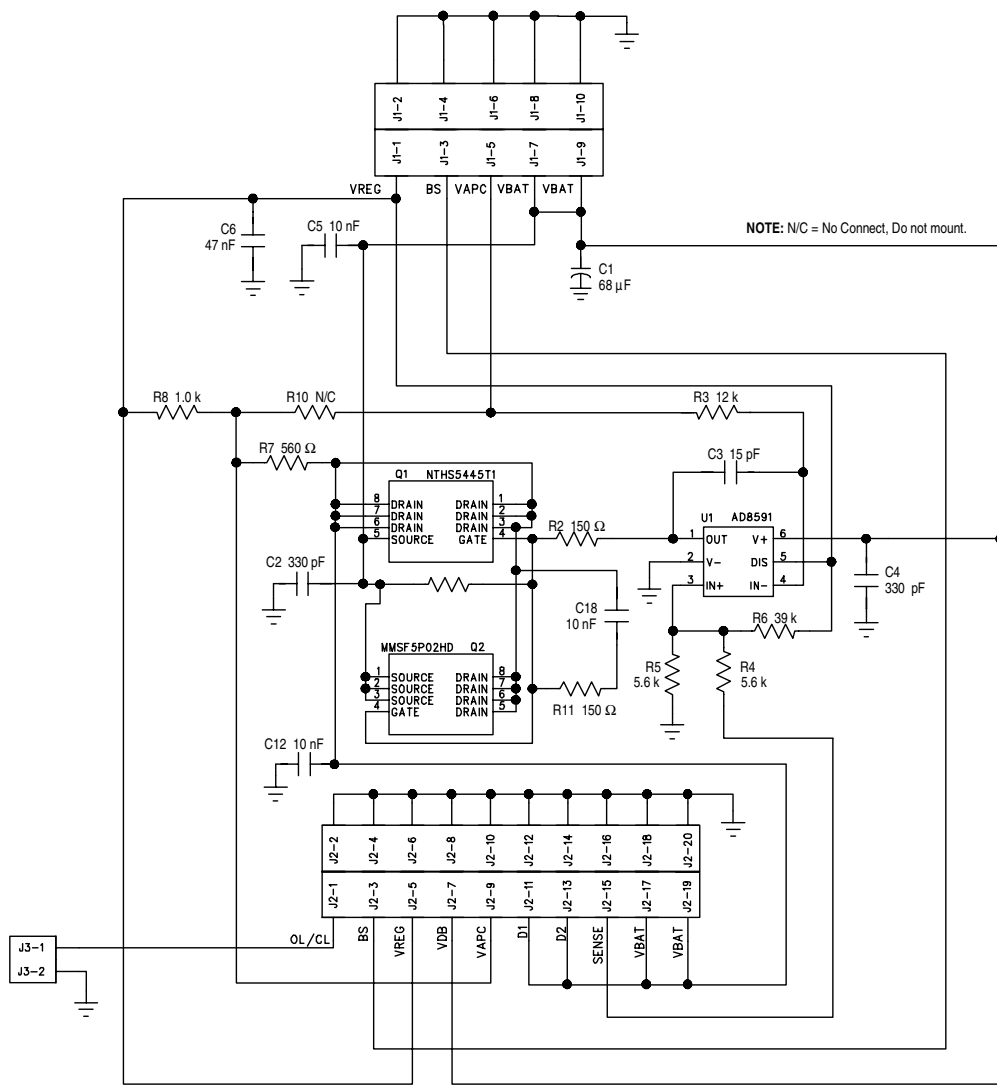

Figure 22. Power Amplifier Control Loop

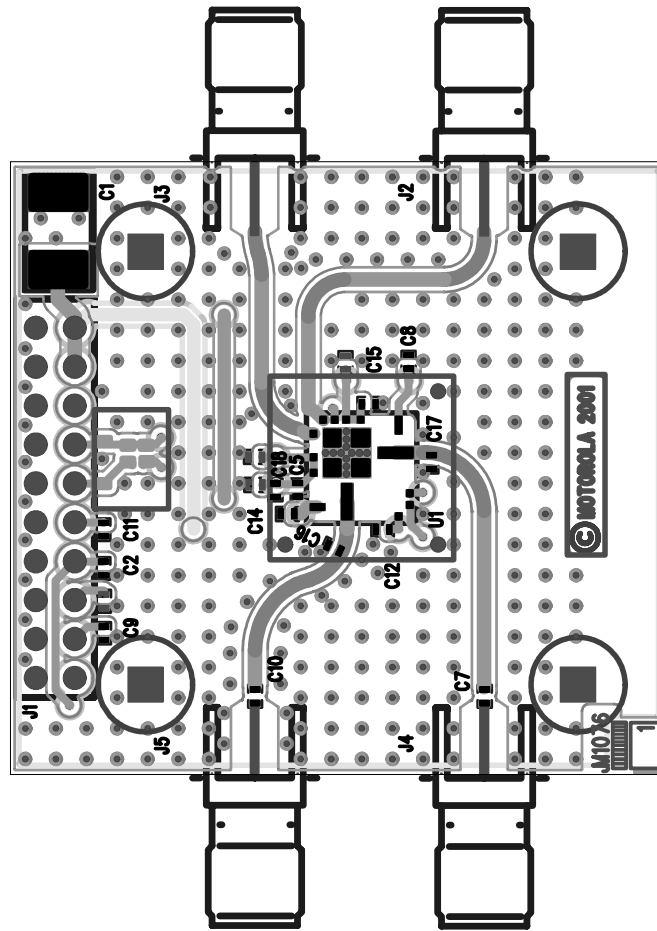

Figure 23. PA Evaluation Circuit PCB

Table 6. PA Evaluation Circuit PCB Bill of Materials

Reference	Value	Part Number	Manufacturer
C1, C3, C4, C6, C13	N/C - Do not mount		
C2	330 pF	GRM36COG330J50	Murata
C5	220 pF	GRM36X7R221K50	Murata
C7, C8, C12	22 pF	GRM36COG220J50	Murata
C9, C14, C15	10 nF	GRM36X7R103K25	Murata
C10	47 pF	GRM36COG470J50	Murata
C11	1.0 nF	GRM36X7R102K25	Murata
C16	6.8 pF	GRM36COG6R8J50	Murata
C17	3.9 pF	GRM36COG3R9J50	Murata
C18	100 nF	GRM36X7R104K25	Murata
J2, J3, J4, J5	50 Ω	142-0711-821	Johnson

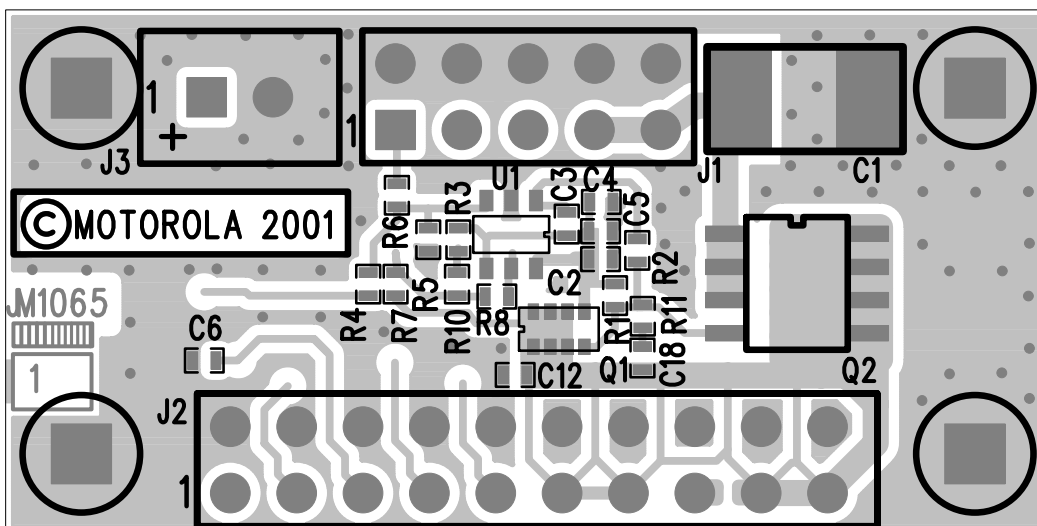

Figure 24. Power Amplifier Control Loop PCB

Table 7. Power Amplifier Control Loop PCB Bill of Materials

Reference	Value	Part Number	Manufacturer
C1	68 μ F	293D685X9020C	Sprague
C2	330 pF	GRM36COG330J50	Murata
C3	15 pF	GRM36COG150J50	Murata
C4	330 pF	GRM36x7R331K50	Murata
C5, C12, C18	10 nF	GRM36X7R103K25	Murata
C6	47 nF	GRM36X7R473K10	Murata
J1, J2, J3	DC connector		
Q1	Power MOSFET	NTHS5445T	ON Semiconductor
Q2	N/C - Do not mount		
R1, R8	1.0 k	CRG0402 5% 1 kO	NEOHM
R2	150 Ω	CRG0402 5% 150 O	NEOHM
R3	12 k	CRG0402 5% 12 kO	NEOHM
R4, R5	5.6 k	CRG0402 5% 5.6 kO	NEOHM
R6, R10	N/C - Do not mount		
R7	560 Ω	CRG0402 5% 560 O	NEOHM
R11	100 Ω	CRG0402 5% 100 O	NEOHM
U1	CMOS Op Amp	AD8591	Analog Devices

5 Packaging Information

Shipping, Packaging and Marking Information

Tape Width: 16.0 mm
 Tape Pitch 12 mm (part to part)
 Reel Diameter: 330 mm (13 in)

Component Orientation: Parts are to be orientated with pin 1 side closest to the tape's round sprocket holes on the tape's trailing edge.

Dry Pack: This device meets Moisture Sensitivity Level (MSL) 3. Parts will be shipped in Dry Pack. Parts must be stored at 30°C and 60% relative humidity with time out of dry pack not to exceed 168 hours.

In the event that parts are not handled or stored within these limits, one of the following dry out procedures must be completed prior to reflow:

- 1) 40°C Dry Out: Bake devices at $40^{\circ}\text{C} \leq T_A \leq 45^{\circ}\text{C}$, 5% Relative Humidity for at least 192 hours.
- 2) Room Temperature Dry Out: Store devices at less than 20% Relative Humidity for at least 500 hours.

Marking:

- 1st line: Motorola Logo
- 2nd Line: Partnumber coded on 7 characters
- 3rd Line: Wafer lot number (coded on 6 characters) followed by wafer number (coded on 3 digits)
- 4th Line: Assy site code (on 1 or 2 characters), followed by Wafer Lot Number (coded on 1 or 2 characters), followed by Year (on 2 digits) and Workweek (on 2 digits).

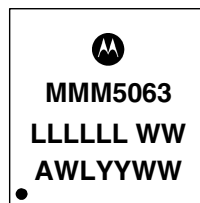

Marking
(Top View)

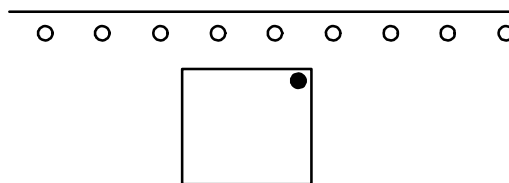

Tape & Reel Orientation
(Top View)

Figure 25. Packaging Information

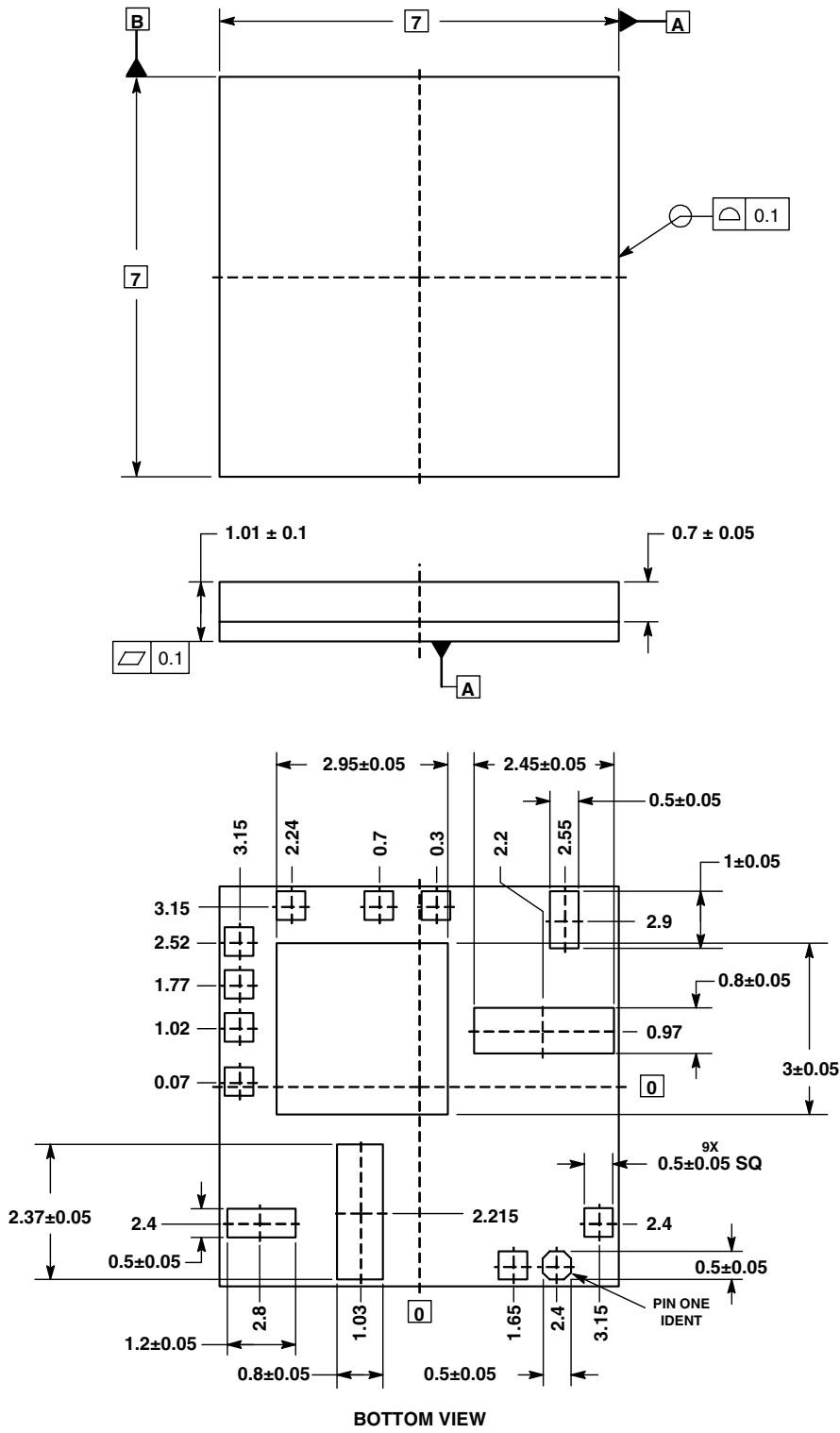

Figure 26. Outline Dimensions for 7x7 mm Module
(Case 1383-02, Issue A)



NOTES

HOW TO REACH US:

USA/EUROPE/LOCATIONS NOT LISTED:

Motorola Literature Distribution;
P.O. Box 5405, Denver, Colorado 80217
1-303-675-2140 or 1-800-441-2447

JAPAN:

Motorola Japan Ltd.; SPS, Technical Information Center,
3-20-1, Minami-Azabu Minato-ku, Tokyo 106-8573 Japan
81-3-3440-3569

ASIA/PACIFIC:

Motorola Semiconductors H.K. Ltd.; Silicon Harbour
Centre, 2 Dai King Street, Tai Po Industrial Estate,
Tai Po, N.T., Hong Kong
852-26668334

TECHNICAL INFORMATION CENTER:

1-800-521-6274

HOME PAGE:

<http://www.motorola.com/semiconductors>

Information in this document is provided solely to enable system and software implementers to use Motorola products. There are no express or implied copyright licenses granted hereunder to design or fabricate any integrated circuits or integrated circuits based on the information in this document.

Motorola reserves the right to make changes without further notice to any products herein. Motorola makes no warranty, representation or guarantee regarding the suitability of its products for any particular purpose, nor does Motorola assume any liability arising out of the application or use of any product or circuit, and specifically disclaims any and all liability, including without limitation consequential or incidental damages. "Typical" parameters which may be provided in Motorola data sheets and/or specifications can and do vary in different applications and actual performance may vary over time. All operating parameters, including "Typicals" must be validated for each customer application by customer's technical experts. Motorola does not convey any license under its patent rights nor the rights of others. Motorola products are not designed, intended, or authorized for use as components in systems intended for surgical implant into the body, or other applications intended to support or sustain life, or for any other application in which the failure of the Motorola product could create a situation where personal injury or death may occur. Should Buyer purchase or use Motorola products for any such unintended or unauthorized application, Buyer shall indemnify and hold Motorola and its officers, employees, subsidiaries, affiliates, and distributors harmless against all claims, costs, damages, and expenses, and reasonable attorney fees arising out of, directly or indirectly, any claim of personal injury or death associated with such unintended or unauthorized use, even if such claim alleges that Motorola was negligent regarding the design or manufacture of the part.



Motorola and the Stylized M Logo are registered in the U.S. Patent and Trademark Office. All other product or service names are the property of their respective owners. Motorola, Inc. is an Equal Opportunity/Affirmative Action Employer.

© Motorola, Inc. 2003

MMM5063/D

**For More Information On This Product,
Go to: www.freescale.com**