

RF Power Field Effect Transistor

N-Channel Enhancement-Mode Lateral MOSFET

Designed for PCN and PCS base station applications with frequencies from 1900 to 2000 MHz. Suitable for TDMA, CDMA and multicarrier amplifier applications.

- Typical 2-Carrier N-CDMA Performance for $V_{DD} = 26$ Volts, $I_{DQ} = 850$ mA, $P_{out} = 18$ Watts Avg., $f_1 = 1930$ MHz, $f_2 = 1932.5$ MHz IS-95 CDMA (Pilot, Sync, Paging, Traffic Codes 8 Through 13) 1.2288 MHz Channel Bandwidth Carrier. Adjacent Channels Measured over a 30 kHz Bandwidth at $f_1 - 885$ KHz and $f_2 + 885$ kHz. Distortion Products Measured over 1.2288 MHz Bandwidth at $f_1 - 2.5$ MHz and $f_2 + 2.5$ MHz. Peak/Avg. = 9.8 dB @ 0.01% Probability on CCDF.
Output Power — 18 Watts Avg.
Power Gain — 13.0 dB
Efficiency — 23%
ACPR — -51 dB
IM3 — -36.5 dBc
- Capable of Handling 5:1 VSWR, @ 26 Vdc, 1960 MHz, 90 Watts CW Output Power

Features

- Internally Matched for Ease of Use
- High Gain, High Efficiency and High Linearity
- Integrated ESD Protection
- Designed for Maximum Gain and Insertion Phase Flatness
- Excellent Thermal Stability
- Characterized with Series Equivalent Large-Signal Impedance Parameters
- Available with Low Gold Plating Thickness on Leads. L Suffix Indicates 40 μ " Nominal.
- RoHS Compliant
- In Tape and Reel. R3 Suffix = 250 Units per 56 mm, 13 Inch Reel.

MRF19085LR3

**1930-1990 MHz, 90 W, 26 V
LATERAL N-CHANNEL
RF POWER MOSFET**

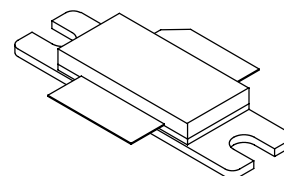

**CASE 465-06, STYLE 1
NI-780**

ARCHIVE INFORMATION

ARCHIVE INFORMATION

Table 1. Maximum Ratings

Rating	Symbol	Value	Unit
Drain-Source Voltage	V_{DSS}	-0.5, +65	Vdc
Gate-Source Voltage	V_{GS}	-0.5, +15	Vdc
Total Device Dissipation @ $T_C = 25^\circ\text{C}$ Derate above 25 $^\circ\text{C}$	P_D	273 1.56	W W/ $^\circ\text{C}$
Storage Temperature Range	T_{stg}	-65 to +150	$^\circ\text{C}$
Case Operating Temperature	T_C	150	$^\circ\text{C}$
Operating Junction Temperature	T_J	200	$^\circ\text{C}$

Table 2. Thermal Characteristics

Characteristic	Symbol	Value ⁽¹⁾	Unit
Thermal Resistance, Junction to Case	$R_{\theta JC}$	0.79	$^\circ\text{C}/\text{W}$

Table 3. ESD Protection Characteristics

Test Conditions	Class
Human Body Model	1 (Minimum)
Machine Model	M3 (Minimum)

1. Refer to AN1955, *Thermal Measurement Methodology of RF Power Amplifiers*. Go to <http://www.freescale.com/rf>.
Select Documentation/Application Notes - AN1955.

Table 4. Electrical Characteristics ($T_C = 25^\circ\text{C}$ unless otherwise noted)

Characteristic	Symbol	Min	Typ	Max	Unit
Off Characteristics					
Drain-Source Breakdown Voltage ($V_{GS} = 0\text{ Vdc}$, $I_D = 100\ \mu\text{Adc}$)	$V_{(BR)DSS}$	65	—	—	Vdc
Zero Gate Voltage Drain Current ($V_{DS} = 26\text{ Vdc}$, $V_{GS} = 0\text{ Vdc}$)	I_{DSS}	—	—	10	μAdc
Gate-Source Leakage Current ($V_{GS} = 5\text{ Vdc}$, $V_{DS} = 0\text{ Vdc}$)	I_{GSS}	—	—	1	μAdc
On Characteristics (DC)					
Gate Threshold Voltage ($V_{DS} = 10\text{ Vdc}$, $I_D = 200\ \mu\text{Adc}$)	$V_{GS(th)}$	2	—	4	Vdc
Gate Quiescent Voltage ($V_{DS} = 26\text{ Vdc}$, $I_D = 850\text{ mAdc}$)	$V_{GS(Q)}$	2.5	3.5	4.5	Vdc
Drain-Source On-Voltage ($V_{GS} = 10\text{ Vdc}$, $I_D = 2\text{ Adc}$)	$V_{DS(on)}$	—	0.18	0.210	Vdc
Forward Transconductance ($V_{DS} = 10\text{ Vdc}$, $I_D = 2\text{ Adc}$)	g_{fs}	—	6	—	S
Dynamic Characteristics					
Reverse Transfer Capacitance ⁽¹⁾ ($V_{DS} = 26\text{ Vdc}$, $V_{GS} = 0$, $f = 1.0\text{ MHz}$)	C_{rss}	—	3.6	—	pF
Functional Tests (In Freescale Test Fixture, 50 ohm system) 2-Carrier N-CDMA, 1.2288 MHz Channel Bandwidth Carriers. Peak/Avg. = 9.8 dB @ 0.01% Probability on CCDF.					
Common-Source Amplifier Power Gain ($V_{DD} = 26\text{ Vdc}$, $P_{out} = 18\text{ W Avg.}$, $I_{DQ} = 850\text{ mA}$, $f_1 = 1930\text{ MHz}$, $f_2 = 1932.5\text{ MHz}$)	G_{ps}	12	13	—	dB
Drain Efficiency ($V_{DD} = 26\text{ Vdc}$, $P_{out} = 18\text{ W Avg.}$, $I_{DQ} = 850\text{ mA}$, $f_1 = 1930\text{ MHz}$, $f_2 = 1932.5\text{ MHz}$)	η	21	23	—	%
3rd Order Intermodulation Distortion ($V_{DD} = 26\text{ Vdc}$, $P_{out} = 18\text{ W Avg.}$, $I_{DQ} = 850\text{ mA}$, $f_1 = 1930\text{ MHz}$, $f_2 = 1932.5\text{ MHz}$; IM3 measured over 1.2288 MHz bandwidth @ $f_1 =$ -2.5 MHz and $f_2 = +2.5\text{ MHz}$)	IMD	—	-36.5	-35	dBc
Adjacent Channel Power Ratio ($V_{DD} = 26\text{ Vdc}$, $P_{out} = 18\text{ W Avg.}$, $I_{DQ} = 850\text{ mA}$, $f_1 = 1930\text{ MHz}$, $f_2 = 1932.5\text{ MHz}$; ACPR measured over 30 kHz bandwidth @ $f_1 =$ -885 MHz and $f_2 = +885\text{ MHz}$)	ACPR	—	-51	-48	dBc
Input Return Loss ($V_{DD} = 26\text{ Vdc}$, $P_{out} = 18\text{ W Avg.}$, $I_{DQ} = 850\text{ mA}$, $f_1 = 1930\text{ MHz}$, $f_2 = 1932.5\text{ MHz}$)	IRL	—	-12	-9	dB

1. Part is internally matched both on input and output.

(continued)

Table 4. Electrical Characteristics ($T_C = 25^\circ\text{C}$ unless otherwise noted) (continued)

Characteristic	Symbol	Min	Typ	Max	Unit
Functional Tests (In Freescale Test Fixture)					
Two-Tone Common-Source Amplifier Power Gain ($V_{DD} = 26\text{ Vdc}$, $P_{out} = 90\text{ W PEP}$, $I_{DQ} = 850\text{ mA}$, $f = 1930\text{ MHz}$ and 1990 MHz , Tone Spacing = 100 kHz)	G_{ps}	—	13	—	dB
Two-Tone Drain Efficiency ($V_{DD} = 26\text{ Vdc}$, $P_{out} = 90\text{ W PEP}$, $I_{DQ} = 850\text{ mA}$, $f = 1930\text{ MHz}$ and 1990 MHz , Tone Spacing = 100 kHz)	η	—	36	—	%
3rd Order Intermodulation Distortion ($V_{DD} = 26\text{ Vdc}$, $P_{out} = 90\text{ W PEP}$, $I_{DQ} = 850\text{ mA}$, $f = 1930\text{ MHz}$ and 1990 MHz , Tone Spacing = 100 kHz)	IMD	—	-31	—	dBc
Input Return Loss ($V_{DD} = 26\text{ Vdc}$, $P_{out} = 90\text{ W PEP}$, $I_{DQ} = 850\text{ mA}$, $f = 1930\text{ MHz}$ and 1990 MHz , Tone Spacing = 100 kHz)	IRL	—	-12	—	dB
P_{out} , 1 dB Compression Point ($V_{DD} = 26\text{ Vdc}$, $I_{DQ} = 850\text{ mA}$, $f = 1990\text{ MHz}$)	P1dB	—	90	—	W

ARCHIVE INFORMATION

ARCHIVE INFORMATION

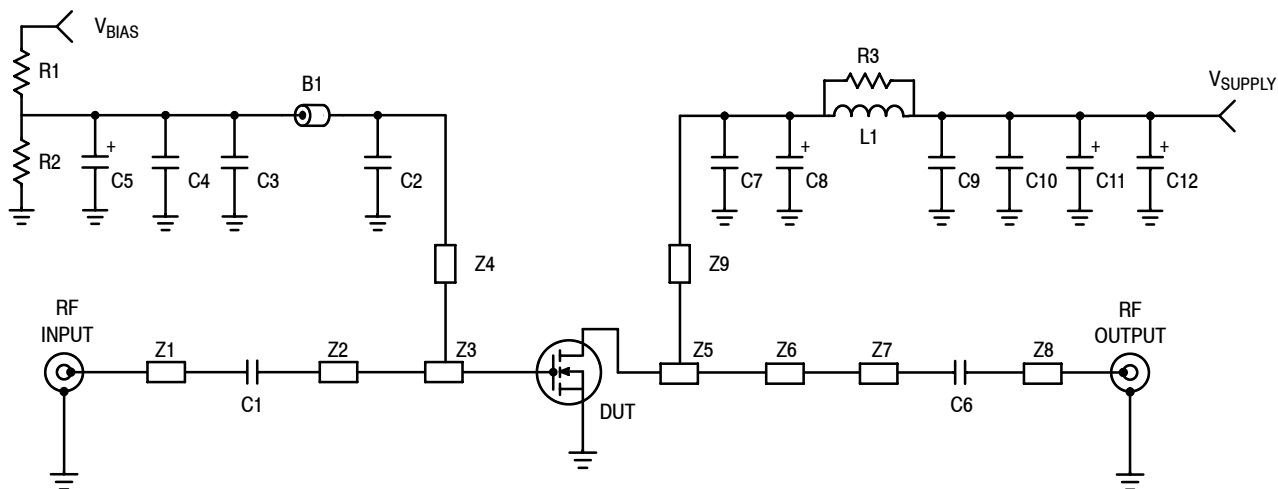

Figure 1. 1930 - 1990 MHz 2-Carrier N-CDMA Test Circuit Schematic

Table 5. 1930 - 1990 MHz 2-Carrier N-CDMA Test Circuit Component Designations and Values

Part	Description	Part Number	Manufacturer
B1	Short Ferrite Bead	2743019447	Fair Rite
C1	51 pF Chip Capacitor	ATC100B510JT500XT	ATC
C2, C7	5.1 pF Chip Capacitors	ATC100B5R1JT500XT	ATC
C3, C9	1000 pF Chip Capacitors	ATC100B102JT500XT	ATC
C4, C10	0.1 μ F Chip Capacitors	CDR33BX104AKYS	Kemet
C5	0.1 μ F Tantalum Surface Mount Capacitor	T491C105M050AT	Kemet
C6	10 pF Chip Capacitor	ATC100B100JT500XT	ATC
C8	10 μ F Tantalum Surface Mount Capacitor	T495D106K035AT	Kemet
C11, C12	22 μ F Tantalum Surface Mount Capacitors	T491D226K035AT	Kemet
L1	1 Turn, 20 AWG, 0.100" ID		
R1	1.0 k Ω , 1/4 W Chip Resistor	CRCW12061001FKEA	Vishay
R2	220 k Ω , 1/4 W Chip Resistor	CRCW12062200FKEA	Vishay
R3	10 Ω , 1/4 W Chip Resistor	CRCW120610R0FKEA	Vishay
Z1	Microstrip	0.750" x 0.0840"	
Z2	Microstrip	1.090" x 0.0840"	
Z3	Microstrip	0.400" x 1.400"	
Z4	Microstrip	0.520" x 0.050"	
Z5	Microstrip	0.540" x 1.133"	
Z6	Microstrip	0.400" x 0.140"	
Z7	Microstrip	0.555" x 0.0840"	
Z8	Microstrip	0.720" x 0.0840"	
Z9	Microstrip	0.560" x 0.070"	
Board	0.030" Glass Teflon [®]	GX-0300-55-22, $\epsilon_r = 2.55$	Arlon
PCB	Etched Circuit Boards	MRF19085 Rev. 4	CMR

ARCHIVE INFORMATION

ARCHIVE INFORMATION

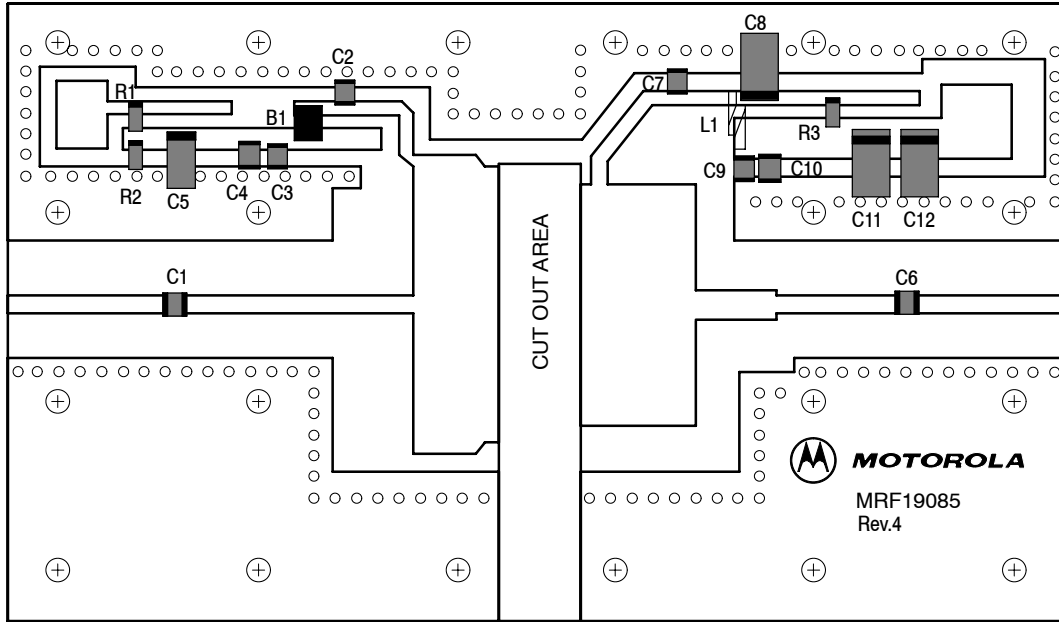

Freescall has begun the transition of marking Printed Circuit Boards (PCBs) with the Freescall Semiconductor signature/logo. PCBs may have either Motorola or Freescall markings during the transition period. These changes will have no impact on form, fit or function of the current product.

Figure 2. 1930 - 1990 MHz 2-Carrier N-CDMA Test Circuit Component Layout

TYPICAL CHARACTERISTICS

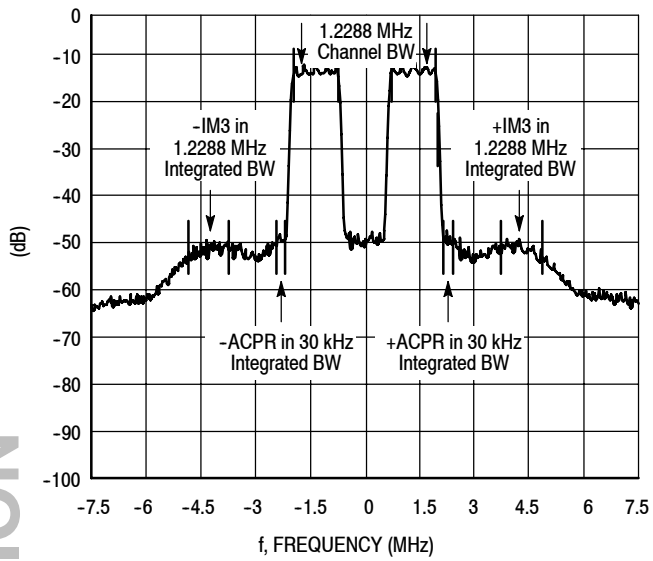

Figure 3. 2-Carrier N-CDMA Spectrum

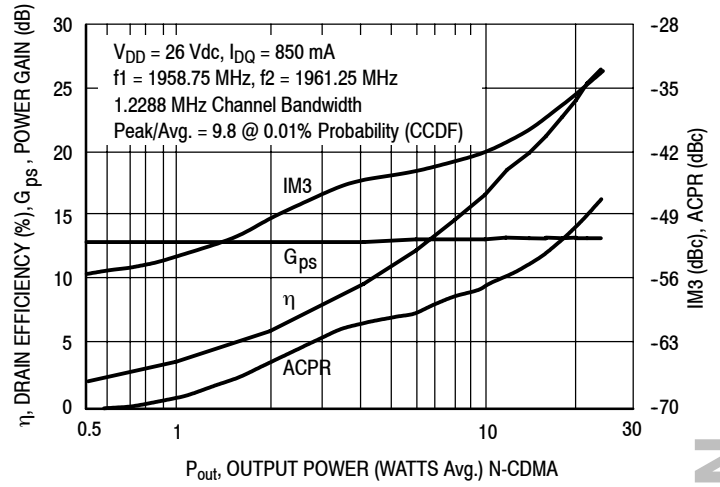

Figure 4. 2-Carrier N-CDMA ACPR, IM3, Power Gain and Drain Efficiency versus Output Power

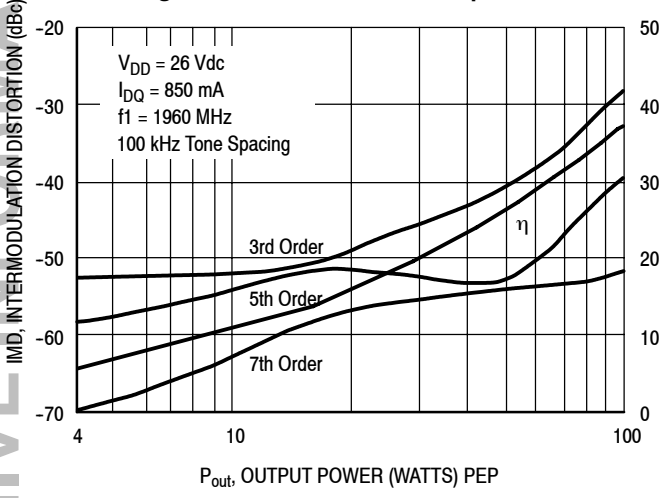

Figure 5. Intermodulation Distortion Products versus Output Power

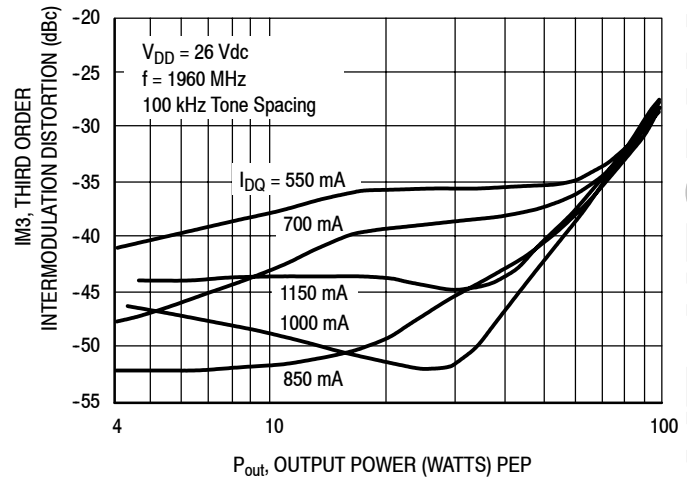

Figure 6. Third Order Intermodulation Distortion versus Output Power and IDQ

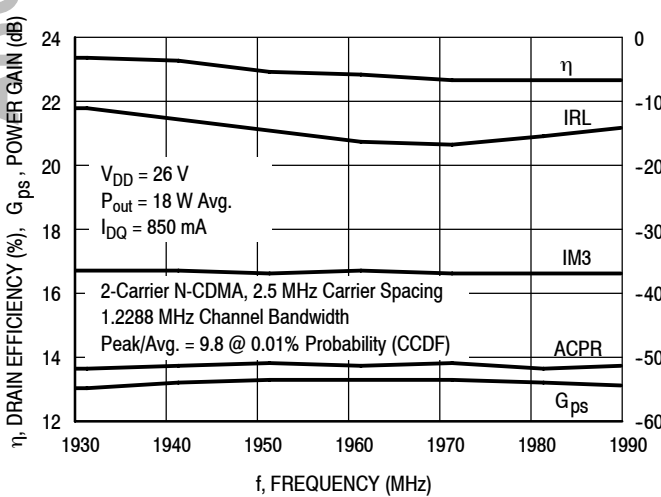

Figure 7. 2-Carrier N-CDMA Broadband Performance

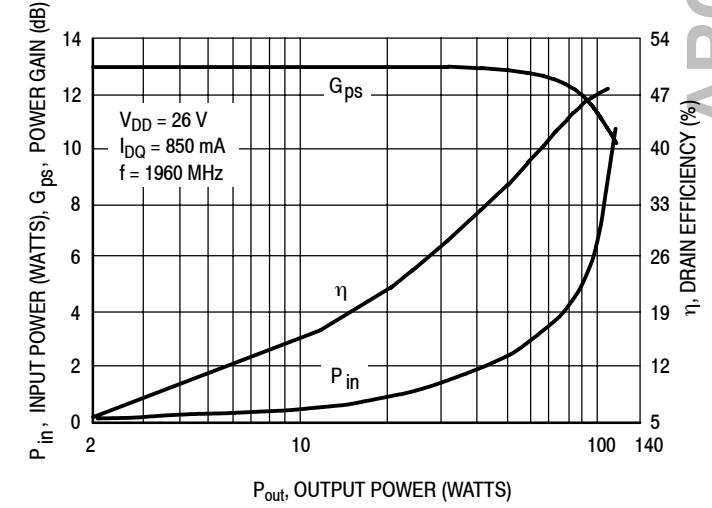

Figure 8. CW Performance

ARCHIVE INFORMATION

ARCHIVE INFORMATION

TYPICAL CHARACTERISTICS

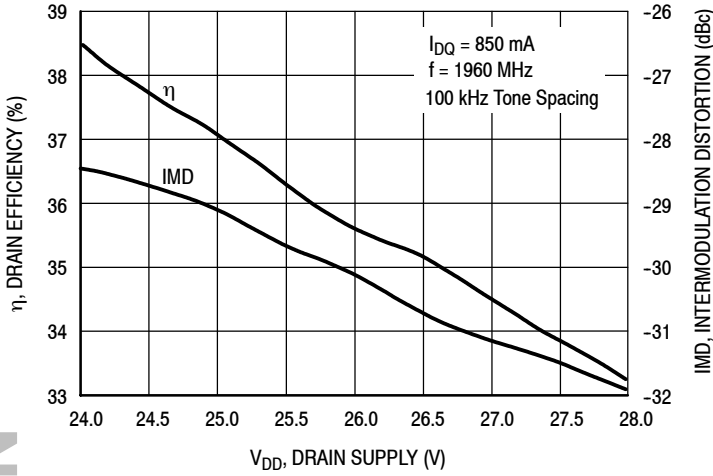

Figure 9. Two-Tone Intermodulation Distortion and Drain Efficiency versus Drain Supply

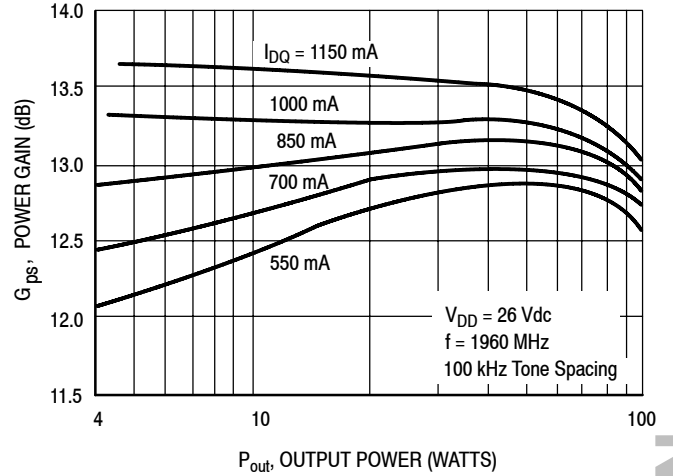

Figure 10. Two-Tone Power Gain versus Output Power

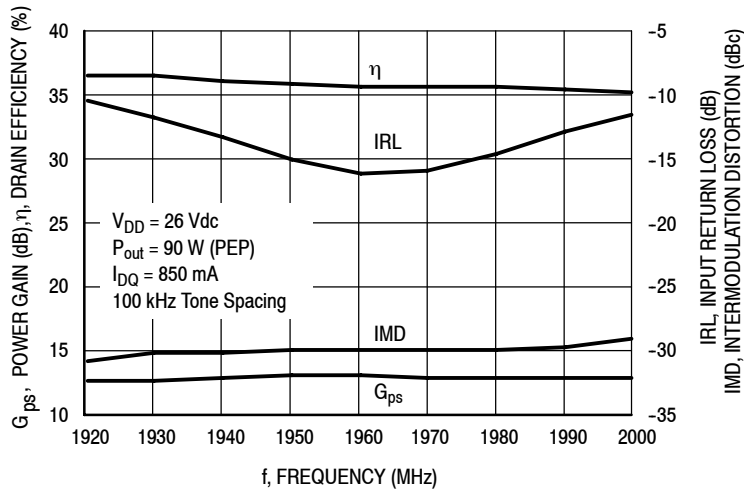
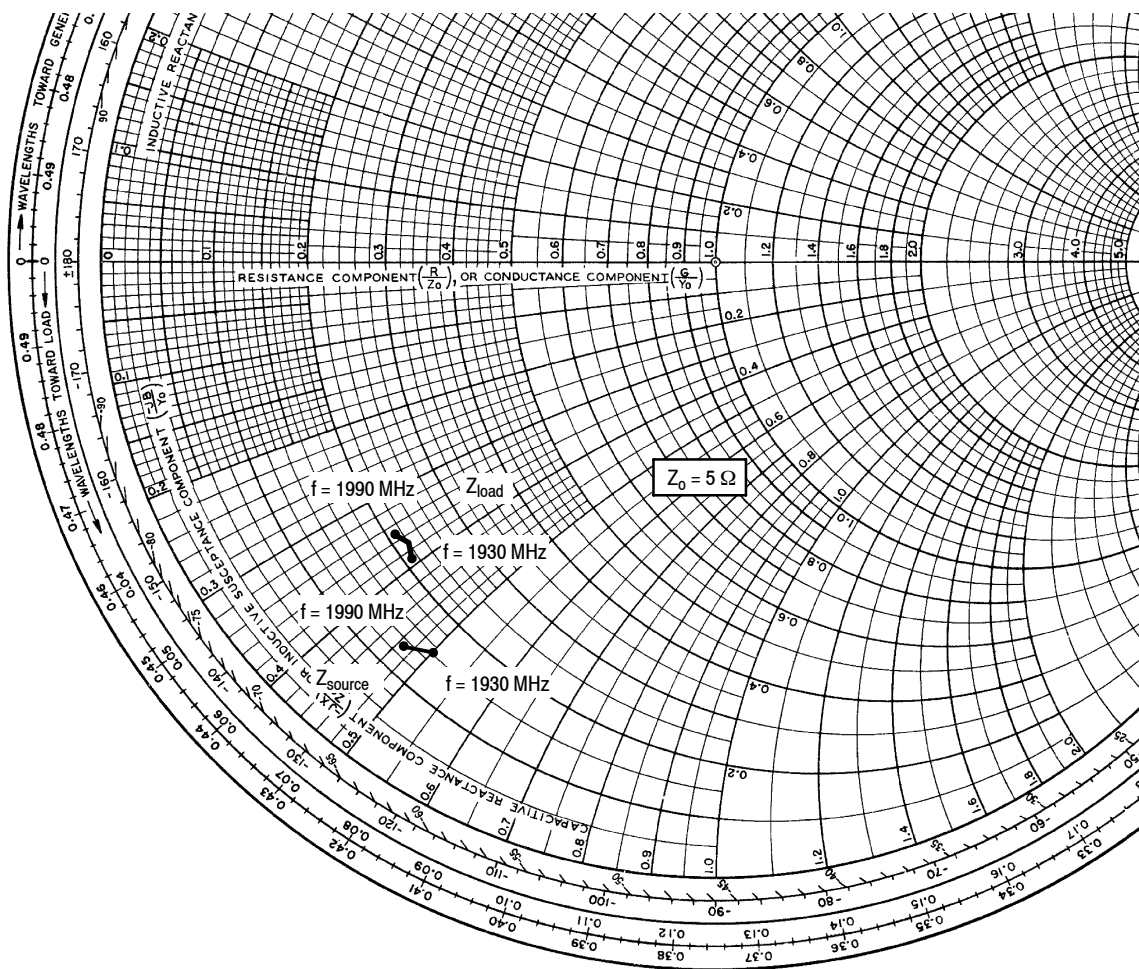

Figure 11. Two-Tone Broadband Performance

ARCHIVE INFORMATION

ARCHIVE INFORMATION



$V_{DD} = 26\text{ V}$, $I_{DQ} = 850\text{ mA}$, $P_{out} = 18\text{ W Avg.}$

f MHz	Z_{source} Ω	Z_{load} Ω
1930	$0.75 - j2.50$	$1.05 - j1.95$
1960	$0.70 - j2.40$	$1.10 - j1.85$
1990	$0.65 - j2.35$	$1.05 - j1.75$

Z_{source} = Test circuit impedance as measured from gate to ground.

Z_{load} = Test circuit impedance as measured from drain to ground.

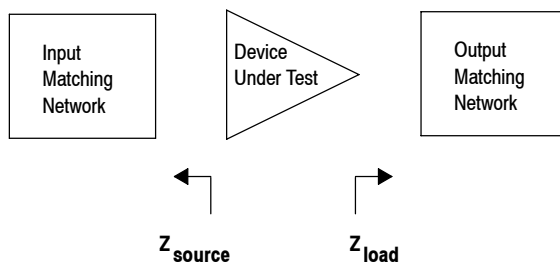
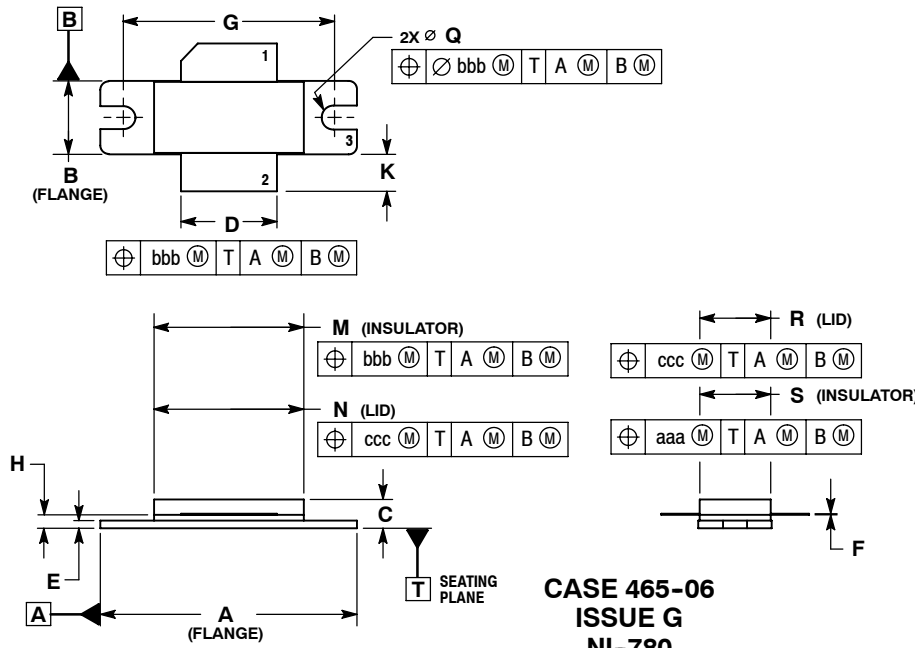

Figure 12. Series Equivalent Source and Load Impedance

PACKAGE DIMENSIONS



- NOTES:
1. DIMENSIONING AND TOLERANCING PER ANSI Y14.5M-1994.
 2. CONTROLLING DIMENSION: INCH.
 3. DELETED
 4. DIMENSION H IS MEASURED 0.030 (0.762) AWAY FROM PACKAGE BODY.

DIM	INCHES		MILLIMETERS	
	MIN	MAX	MIN	MAX
A	1.335	1.345	33.91	34.16
B	0.380	0.390	9.65	9.91
C	0.125	0.170	3.18	4.32
D	0.495	0.505	12.57	12.83
E	0.035	0.045	0.89	1.14
F	0.003	0.006	0.08	0.15
G	1.100 BSC		27.94 BSC	
H	0.057	0.067	1.45	1.70
K	0.170	0.210	4.32	5.33
M	0.774	0.786	19.66	19.96
N	0.772	0.788	19.60	20.00
Q	$\varnothing 1.118$	$\varnothing 1.138$	$\varnothing 3.00$	$\varnothing 3.51$
R	0.365	0.375	9.27	9.53
S	0.365	0.375	9.27	9.52
aaa	0.005 REF		0.127 REF	
bbb	0.010 REF		0.254 REF	
ccc	0.015 REF		0.381 REF	

- STYLE 1:
 PIN 1. DRAIN
 2. GATE
 3. SOURCE

**CASE 465-06
 ISSUE G
 NI-780
 MRF19085LR3**

ARCHIVE INFORMATION

ARCHIVE INFORMATION

PRODUCT DOCUMENTATION

Refer to the following documents to aid your design process.

Application Notes

- AN1955: Thermal Measurement Methodology of RF Power Amplifiers

Engineering Bulletins

- EB212: Using Data Sheet Impedances for RF LDMOS Devices

REVISION HISTORY

The following table summarizes revisions to this document.

Revision	Date	Description
10	Oct. 2008	<ul style="list-style-type: none"> • Data sheet revised to reflect part status change, p. 1, including use of applicable overlay. • Modified data sheet to reflect RF Test Reduction described in Product and Process Change Notification number, PCN12779, p. 1, 2 • Updated Part Numbers in Table 5, Component Designations and Values, to RoHS compliant part numbers, p. 4 • Added Product Documentation and Revision History, p. 10 • Data sheet split due to change in part life cycle (-1, -2 added to enable visibility on web).
	Dec. 2010	<ul style="list-style-type: none"> • MRF19085-2 Rev. 10 (MRF19085LR3) data sheet archived. Part no longer manufactured. See MRF19085-1 Rev. 9 for MRF19085LSR3.

ARCHIVE INFORMATION

ARCHIVE INFORMATION

How to Reach Us:

Home Page:

www.freescale.com

Web Support:

<http://www.freescale.com/support>

USA/Europe or Locations Not Listed:

Freescale Semiconductor, Inc.
 Technical Information Center, EL516
 2100 East Elliot Road
 Tempe, Arizona 85284
 1-800-521-6274 or +1-480-768-2130
www.freescale.com/support

Europe, Middle East, and Africa:

Freescale Halbleiter Deutschland GmbH
 Technical Information Center
 Schatzbogen 7
 81829 Muenchen, Germany
 +44 1296 380 456 (English)
 +46 8 52200080 (English)
 +49 89 92103 559 (German)
 +33 1 69 35 48 48 (French)
www.freescale.com/support

Japan:

Freescale Semiconductor Japan Ltd.
 Headquarters
 ARCO Tower 15F
 1-8-1, Shimo-Meguro, Meguro-ku,
 Tokyo 153-0064
 Japan
 0120 191014 or +81 3 5437 9125
support.japan@freescale.com

Asia/Pacific:

Freescale Semiconductor China Ltd.
 Exchange Building 23F
 No. 118 Jianguo Road
 Chaoyang District
 Beijing 100022
 China
 +86 10 5879 8000
support.asia@freescale.com

For Literature Requests Only:

Freescale Semiconductor Literature Distribution Center
 P.O. Box 5405
 Denver, Colorado 80217
 1-800-441-2447 or +1-303-675-2140
 Fax: +1-303-675-2150
LDCForFreescaleSemiconductor@hibbertgroup.com

Information in this document is provided solely to enable system and software implementers to use Freescale Semiconductor products. There are no express or implied copyright licenses granted hereunder to design or fabricate any integrated circuits or integrated circuits based on the information in this document.

Freescale Semiconductor reserves the right to make changes without further notice to any products herein. Freescale Semiconductor makes no warranty, representation or guarantee regarding the suitability of its products for any particular purpose, nor does Freescale Semiconductor assume any liability arising out of the application or use of any product or circuit, and specifically disclaims any and all liability, including without limitation consequential or incidental damages. "Typical" parameters that may be provided in Freescale Semiconductor data sheets and/or specifications can and do vary in different applications and actual performance may vary over time. All operating parameters, including "Typicals", must be validated for each customer application by customer's technical experts. Freescale Semiconductor does not convey any license under its patent rights nor the rights of others. Freescale Semiconductor products are not designed, intended, or authorized for use as components in systems intended for surgical implant into the body, or other applications intended to support or sustain life, or for any other application in which the failure of the Freescale Semiconductor product could create a situation where personal injury or death may occur. Should Buyer purchase or use Freescale Semiconductor products for any such unintended or unauthorized application, Buyer shall indemnify and hold Freescale Semiconductor and its officers, employees, subsidiaries, affiliates, and distributors harmless against all claims, costs, damages, and expenses, and reasonable attorney fees arising out of, directly or indirectly, any claim of personal injury or death associated with such unintended or unauthorized use, even if such claim alleges that Freescale Semiconductor was negligent regarding the design or manufacture of the part.

Freescale™ and the Freescale logo are trademarks of Freescale Semiconductor, Inc. All other product or service names are the property of their respective owners.

© Freescale Semiconductor, Inc. 2008, 2010. All rights reserved.