

RF Power Field Effect Transistor

N-Channel Enhancement-Mode Lateral MOSFET

Designed for PCN and PCS base station applications at frequencies from 1900 to 2000 MHz. Suitable for TDMA, CDMA and multicarrier amplifier applications.

- Typical 2-Carrier N-CDMA Performance for $V_{DD} = 28$ Volts, $I_{DQ} = 1200$ mA, $P_{out} = 26$ Watts Avg., $f = 1990$ MHz, IS-95 CDMA (Pilot, Sync, Paging, Traffic Codes 8 Through 13) Channel Bandwidth = 1.2288 MHz. PAR = 9.8 dB @ 0.01% Probability on CCDF.
 Power Gain — 13 dB
 Drain Efficiency — 25%
 IM3 @ 2.5 MHz Offset — -37 dBc in 1.2288 MHz Bandwidth
 ACPR @ 885 kHz Offset — -51 dB in 30 kHz Bandwidth
- Capable of Handling 10:1 VSWR, @ 28 Vdc, 1960 MHz, 110 Watts CW Output Power

Features

- Characterized with Series Equivalent Large-Signal Impedance Parameters
- Internally Matched for Ease of Use
- Qualified Up to a Maximum of 32 V Operation
- Integrated ESD Protection
- Lower Thermal Resistance Package
- Low Gold Plating Thickness on Leads, 40 μ m Nominal.
- RoHS Compliant
- In Tape and Reel. R3 Suffix = 250 Units per 56 mm, 13 inch Reel.

MRF5S19130HR3

**1930-1990 MHz, 26 W AVG., 28 V
 2 x N-CDMA
 LATERAL N-CHANNEL
 RF POWER MOSFET**

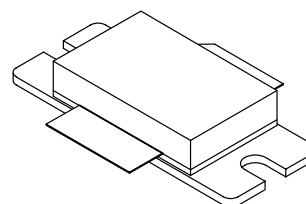

**CASE 465B-03, STYLE 1
 NI-880**

LIFETIME BUY

LAST SHIP 14 MAY 09
 LAST ORDER 3 OCT 08

Table 1. Maximum Ratings

Rating	Symbol	Value	Unit
Drain-Source Voltage	V_{DSS}	-0.5, +65	Vdc
Gate-Source Voltage	V_{GS}	-0.5, +15	Vdc
Total Device Dissipation @ $T_C = 25^\circ\text{C}$ Derate above 25°C	P_D	438 2.50	W W/ $^\circ\text{C}$
Storage Temperature Range	T_{stg}	- 65 to +150	$^\circ\text{C}$
Case Operating Temperature	T_C	150	$^\circ\text{C}$
Operating Junction Temperature	T_J	200	$^\circ\text{C}$
CW Operation @ $T_C = 25^\circ\text{C}$ Derate above 25°C	CW	160 1	W W/ $^\circ\text{C}$

Table 2. Thermal Characteristics

Characteristic	Symbol	Value (1,2)	Unit
Thermal Resistance, Junction to Case Case Temperature 80°C , 115 W CW Case Temperature 78°C , 26 W CW	$R_{\theta JC}$	0.40 0.46	$^\circ\text{C}/\text{W}$

1. MTTF calculator available at <http://www.freescale.com/rf>. Select Software & Tools/Development Tools/Calculators to access MTTF calculators by product.
2. Refer to AN1955, *Thermal Measurement Methodology of RF Power Amplifiers*. Go to <http://www.freescale.com/rf>. Select Documentation/Application Notes - AN1955.

Table 3. ESD Protection Characteristics

Test Conditions	Class
Human Body Model	2 (Minimum)
Machine Model	M4 (Minimum)
Charge Device Model	C7 (Minimum)

Table 4. Electrical Characteristics ($T_C = 25^\circ\text{C}$ unless otherwise noted)

Characteristic	Symbol	Min	Typ	Max	Unit
Off Characteristics					
Zero Gate Voltage Drain Leakage Current ($V_{DS} = 65\text{ Vdc}$, $V_{GS} = 0\text{ Vdc}$)	I_{DSS}	—	—	10	μAdc
Zero Gate Voltage Drain Leakage Current ($V_{DS} = 28\text{ Vdc}$, $V_{GS} = 0\text{ Vdc}$)	I_{DSS}	—	—	1	μAdc
Gate-Source Leakage Current ($V_{GS} = 5\text{ Vdc}$, $V_{DS} = 0\text{ Vdc}$)	I_{GSS}	—	—	1	μAdc

On Characteristics

Gate Threshold Voltage ($V_{DS} = 10\text{ Vdc}$, $I_D = 200\ \mu\text{Adc}$)	$V_{GS(th)}$	2.5	2.8	3.5	Vdc
Gate Quiescent Voltage ($V_{DS} = 28\text{ Vdc}$, $I_D = 1200\ \text{mAdc}$)	$V_{GS(Q)}$	—	3.8	—	Vdc
Drain-Source On-Voltage ($V_{GS} = 10\text{ Vdc}$, $I_D = 3\text{ Adc}$)	$V_{DS(on)}$	—	0.26	—	Vdc
Forward Transconductance ($V_{DS} = 10\text{ Vdc}$, $I_D = 3\text{ Adc}$)	g_{fs}	—	7.5	—	S

Dynamic Characteristics

Reverse Transfer Capacitance ⁽¹⁾ ($V_{DS} = 28\text{ Vdc} \pm 30\text{ mV(rms)ac}$ @ 1 MHz, $V_{GS} = 0\text{ Vdc}$)	C_{rss}	—	2.7	—	pF
--	-----------	---	-----	---	----

Functional Tests (In Freescale Test Fixture, 50 ohm system) $V_{DD} = 28\text{ Vdc}$, $I_{DQ} = 1200\text{ mA}$, $P_{out} = 26\text{ W Avg.}$, $f_1 = 1987.5\text{ MHz}$, $f_2 = 1990\text{ MHz}$, 2-Carrier N-CDMA, 1.2288 MHz Channel Bandwidth Carriers. ACPR measured in 30 kHz Channel Bandwidth @ $\pm 885\text{ kHz}$ Offset. IM3 measured in 1.2288 MHz Channel Bandwidth @ $\pm 2.5\text{ MHz}$ Offset. PAR = 9.8 dB @ 0.01% Probability on CCDF.

Power Gain	G_{ps}	12	13	—	dB
Drain Efficiency	η_D	23	25	—	%
Intermodulation Distortion	IM3	—	-37	-35	dBc
Adjacent Channel Power Ratio	ACPR	—	-51	-48	dBc
Input Return Loss	IRL	—	-15	-9	dB

- Part internally matched both on input and output.

LIFETIME BUY

LAST ORDER 3 OCT 08 LAST SHIP 14 MAY 09

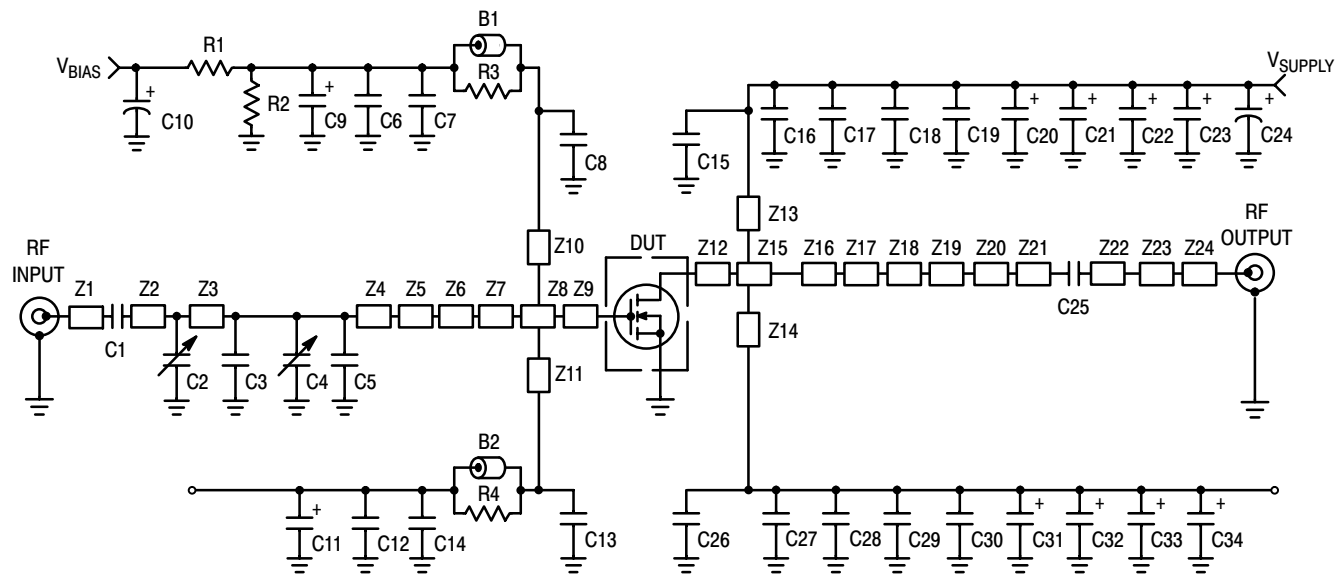

Z1	0.200" x 0.085" Microstrip	Z13, Z14	1.125" x 0.068" Microstrip
Z2	0.170" x 0.085" Microstrip	Z15	0.071" x 1.080" Microstrip
Z3	0.480" x 0.085" Microstrip	Z16	0.060" x 1.080" Microstrip
Z4	0.926" x 0.085" Microstrip	Z17	0.290" x 1.080" Microstrip
Z5	0.590" x 0.085" Microstrip	Z18	1.075" x 0.825" x 0.125" Taper
Z6	0.519" x 0.955" x 0.160" Taper	Z19	0.635" x 0.120" Microstrip
Z7	0.022" x 0.955" Microstrip	Z20	0.185" x 0.096" Microstrip
Z8	0.046" x 0.955" Microstrip	Z21	0.414" x 0.084" Microstrip
Z9	0.080" x 0.955" Microstrip	Z22	0.040" x 0.084" Microstrip
Z10, Z11	1.280" x 0.046" Microstrip	Z23	0.199" x 0.057" Microstrip
Z12	0.053" x 1.080" Microstrip	PCB	Arlon GX0300-55-22, 0.03", $\epsilon_r = 2.55$

Figure 1. MRF5S19130HR3 Test Circuit Schematic

Table 5. MRF5S19130HR3 Test Circuit Component Designations and Values

Part	Description	Part Number	Manufacturer
B1, B2	Short RF Beads	2743019447	Fair-Rite
C1	0.8 pF Chip Capacitor	ATC100B0R8BT500XT	ATC
C2, C4	0.6 – 4.5 pF Gigatrim Variable Capacitors	27271SL	Johanson
C3	2.2 pF Chip Capacitor	ATC100B2R2BT500XT	ATC
C5	1.7 pF Chip Capacitor	ATC100B1R7BT500XT	ATC
C8, C13	9.1 pF Chip Capacitors	ATC100B9R1CT500XT	ATC
C9, C11	1 μ F, 25 V Tantalum Capacitors	T491C105K05AS	Kemet
C10	47 μ F, 50 V Electrolytic Capacitor	515D107M050BB6AE3	Vishay
C6, C14, C17, C18, C19, C28, C29, C30	0.1 μ F Chip Capacitors	CDR33BX104AKYS	Kemet
C7, C12, C16, C27	1000 pF Chip Capacitors	ATC100B102JT50XT	ATC
C15, C26	8.2 pF Chip Capacitors	ATC100B8R2CT500XT	ATC
C20, C21, C22, C23, C31, C32, C33, C34	22 μ F, 35 V Tantalum Capacitors	T491D226M035AS	Kemet
C24	470 μ F, 63 V Electrolytic Capacitor	EKME630ELL471MK25S	Multicomp
C25	6.2 pF Chip Capacitor	ATC100B6R2CT500XT	ATC
R1	1 k Ω , 1/4 W Chip Resistor	CRCW12061001FKEA	Vishay
R2	560 k Ω , 1/4 W Chip Resistor	CRCW12065600FKEA	Vishay
R3, R4	12 Ω , 1/4 W Chip Resistors	CRCW120612R0FKEA	Vishay

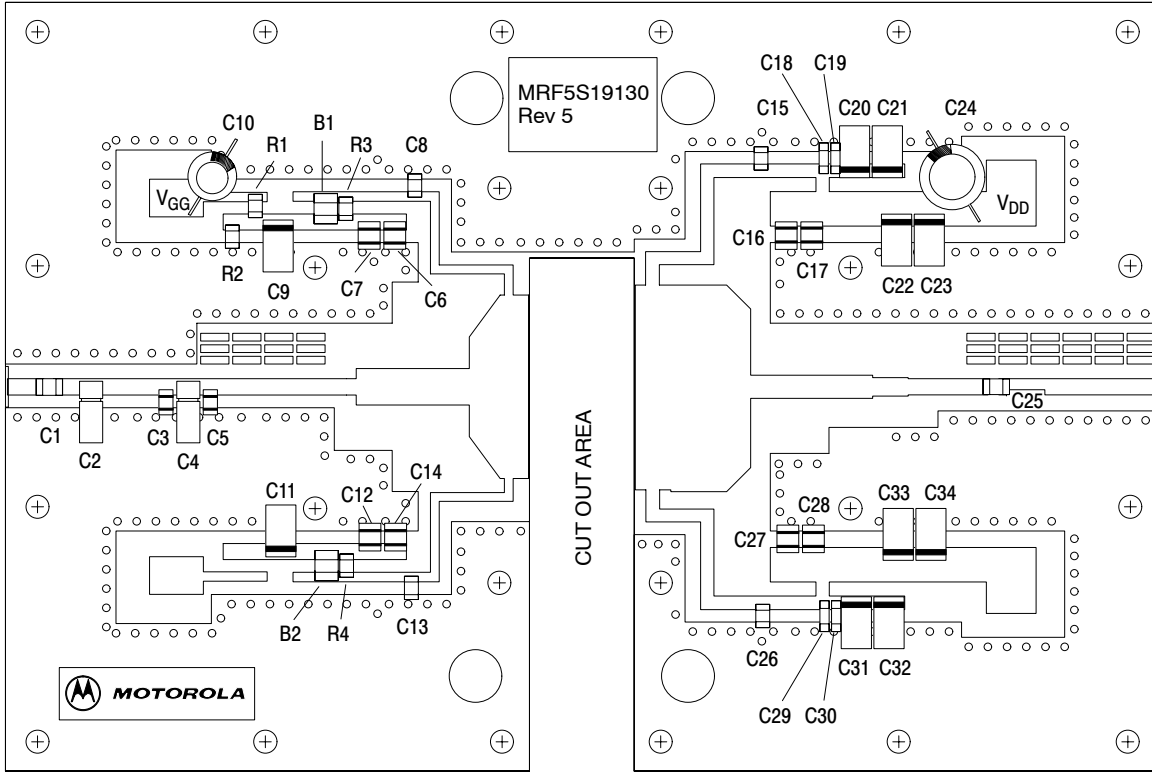

Freescall has begun the transition of marking Printed Circuit Boards (PCBs) with the Freescall Semiconductor signature/logo. PCBs may have either Motorola or Freescall markings during the transition period. These changes will have no impact on form, fit or function of the current product.

Figure 2. MRF5S19130HR3 Test Circuit Component Layout

TYPICAL CHARACTERISTICS

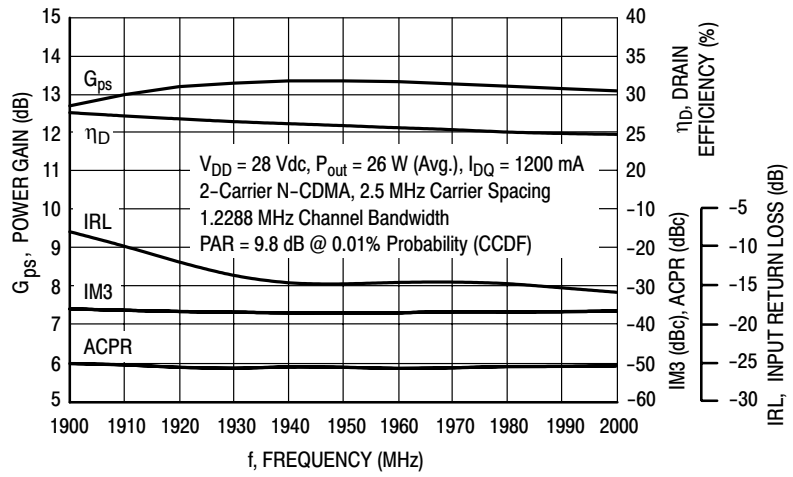

Figure 3. 2-Carrier N-CDMA Broadband Performance @ P_{out} = 26 Watts Avg.

LIFETIME BUY

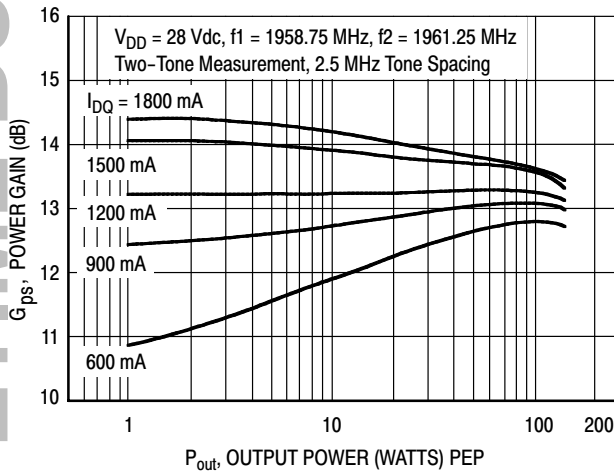

Figure 4. Two-Tone Power Gain versus Output Power

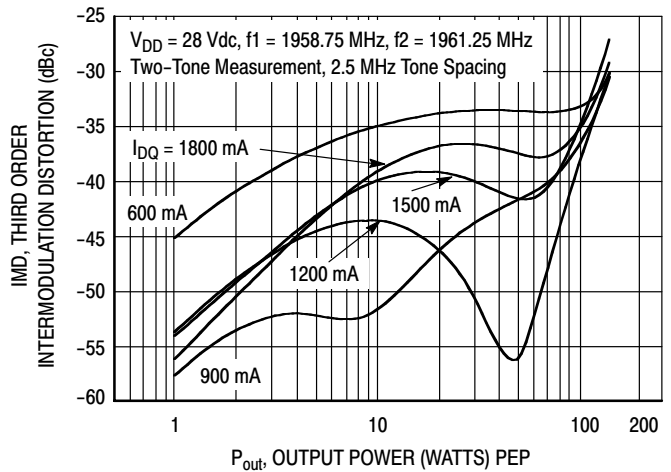

Figure 5. Third Order Intermodulation Distortion versus Output Power

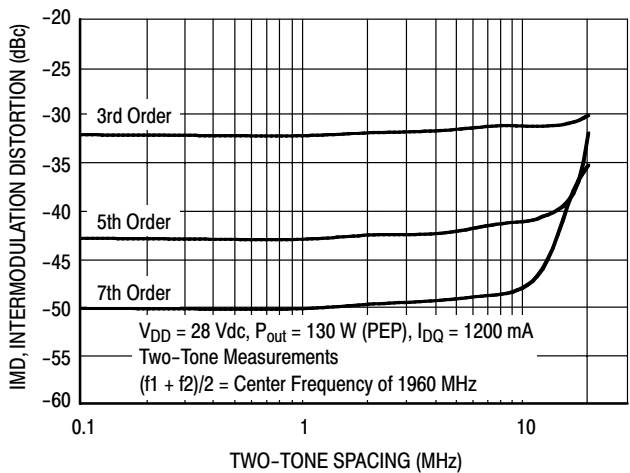

Figure 6. Intermodulation Distortion Products versus Tone Spacing

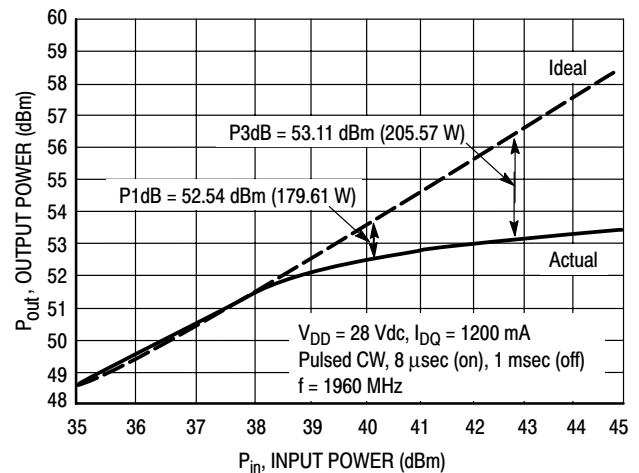

Figure 7. Pulse CW Output Power versus Input Power

LAST ORDER 3 OCT 08 LAST SHIP 14 MAY 09

TYPICAL CHARACTERISTICS

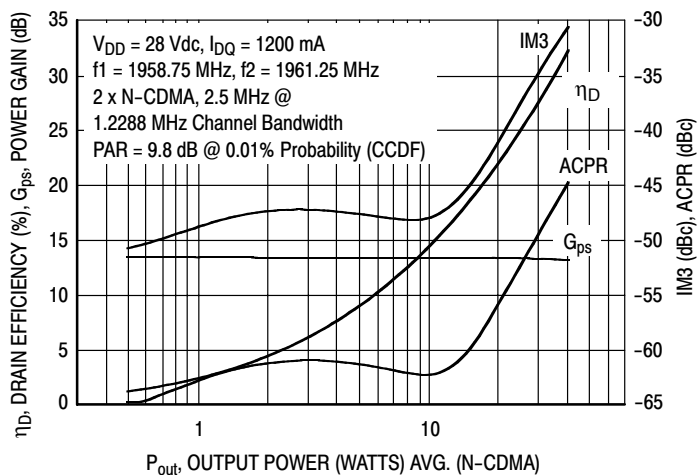
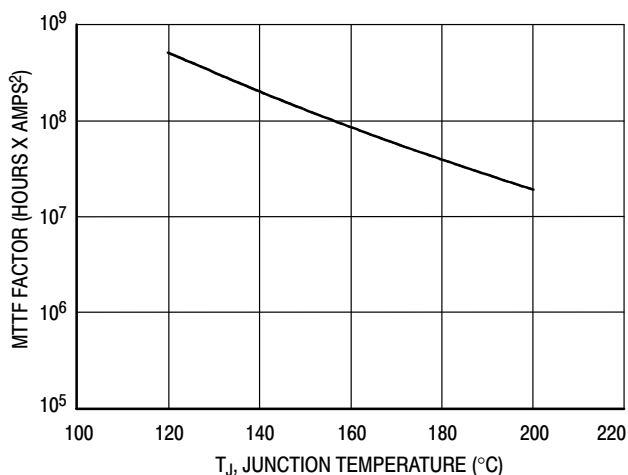

Figure 8. 2-Carrier N-CDMA ACPR, IM3, Power Gain and Drain Efficiency versus Output Power



This above graph displays calculated MTTF in hours x ampere² drain current. Life tests at elevated temperatures have correlated to better than $\pm 10\%$ of the theoretical prediction for metal failure. Divide MTTF factor by I_D^2 for MTTF in a particular application.

Figure 9. MTTF Factor versus Junction Temperature

N-CDMA TEST SIGNAL

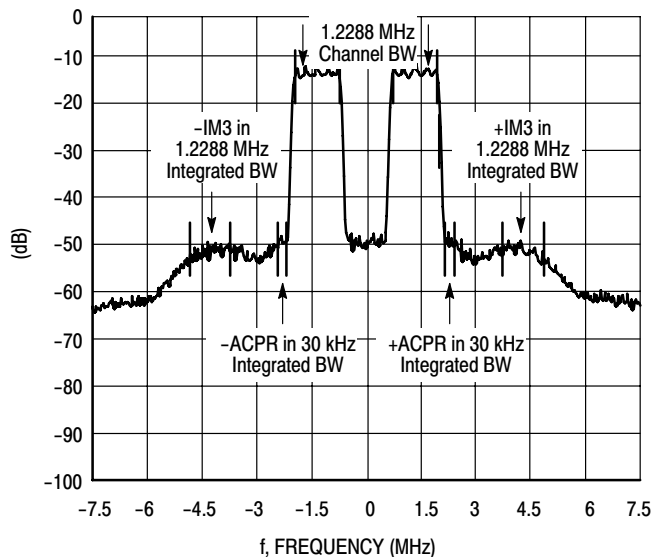
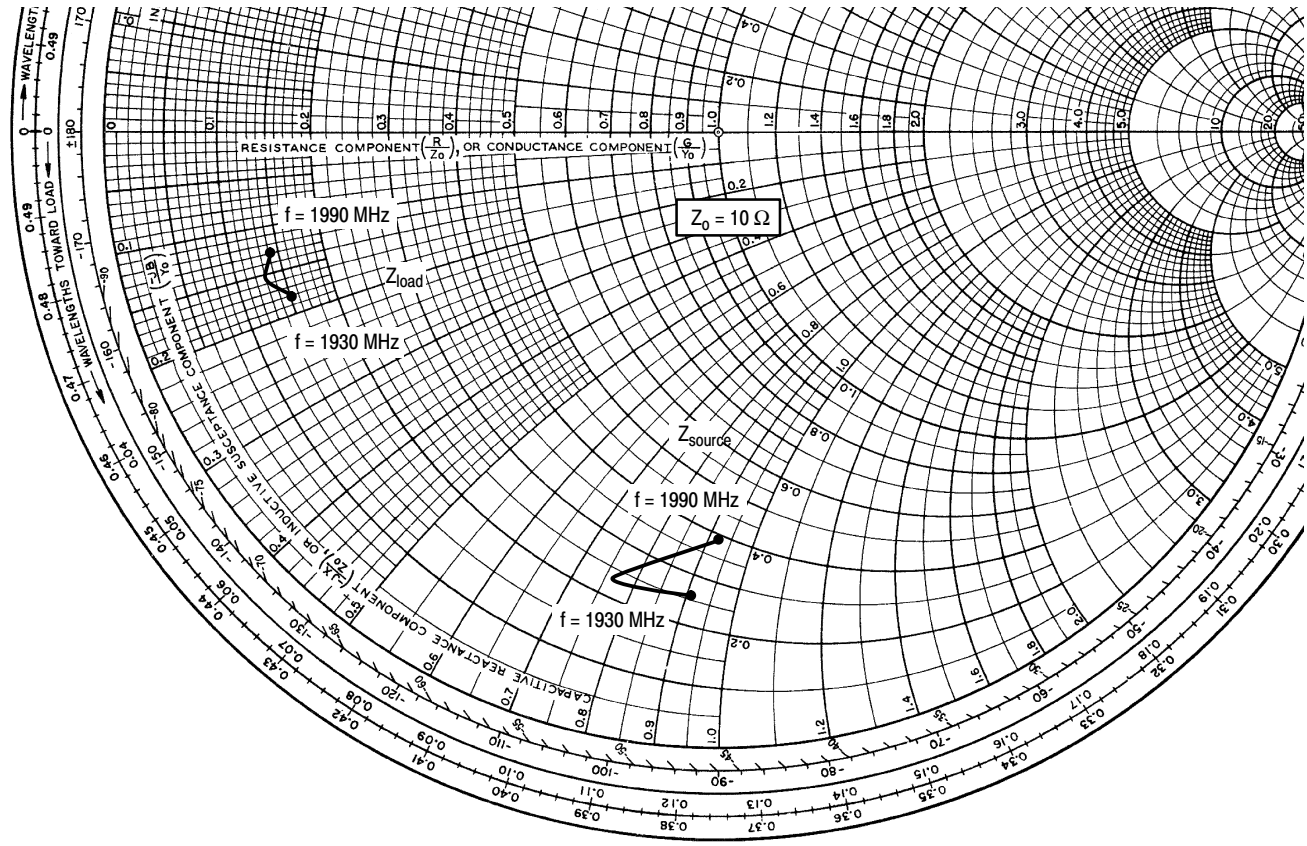

Figure 10. 2-Carrier N-CDMA Spectrum

LIFETIME BUY

LAST ORDER 3 OCT 08 LAST SHIP 14 MAY 09



$V_{DD} = 28\text{ V}$, $I_{DQ} = 1.2\text{ A}$, $P_{out} = 26\text{ W Avg.}$

f MHz	Z_{source} Ω	Z_{load} Ω
1930	$2.57 - j9.1$	$1.48 - j1.8$
1960	$2.35 - j7.6$	$1.28 - j1.5$
1990	$3.86 - j9.2$	$1.42 - j1.3$

Z_{source} = Test circuit impedance as measured from gate to ground.

Z_{load} = Test circuit impedance as measured from drain to ground.

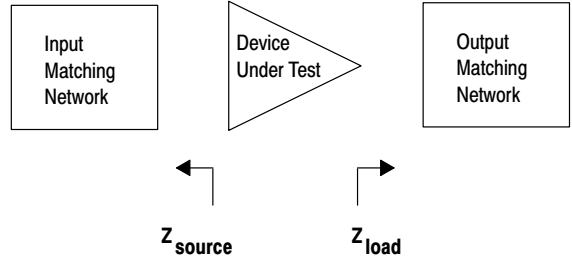
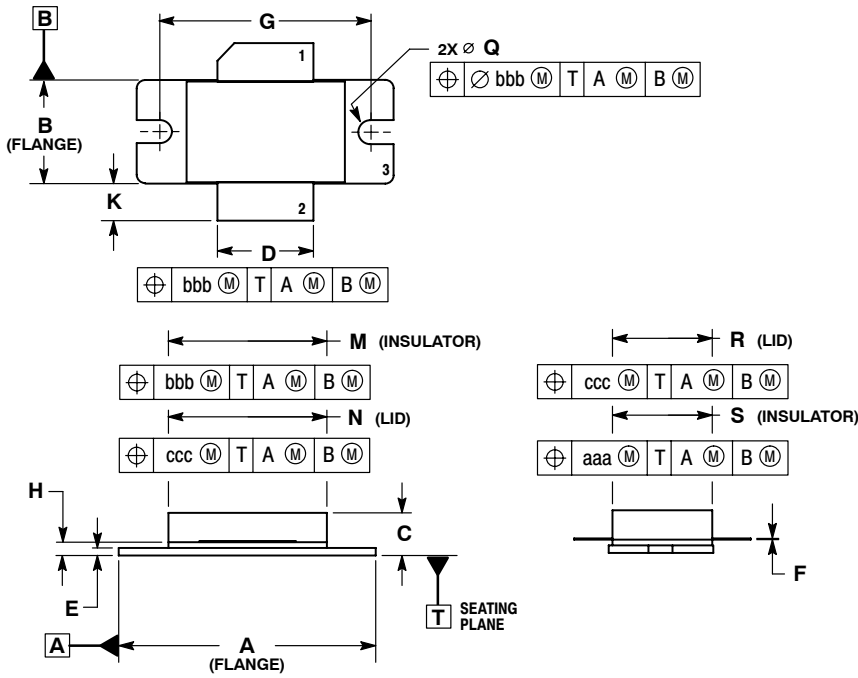

Figure 11. Series Equivalent Source and Load Impedance

PACKAGE DIMENSIONS



- NOTES:
1. DIMENSIONING AND TOLERANCING PER ANSI Y14.5M-1994.
 2. CONTROLLING DIMENSION: INCH.
 3. DIMENSION H IS MEASURED 0.030 (0.762) AWAY FROM PACKAGE BODY.
 4. DELETED

DIM	INCHES		MILLIMETERS	
	MIN	MAX	MIN	MAX
A	1.335	1.345	33.91	34.16
B	0.535	0.545	13.6	13.8
C	0.147	0.200	3.73	5.08
D	0.495	0.505	12.57	12.83
E	0.035	0.045	0.89	1.14
F	0.003	0.006	0.08	0.15
G	1.100 BSC		27.94 BSC	
H	0.057	0.067	1.45	1.70
K	0.170	0.210	4.32	5.33
M	0.872	0.888	22.15	22.55
N	0.871	0.889	19.30	22.60
Q	∅.118	∅.138	∅3.00	∅3.51
R	0.515	0.525	13.10	13.30
S	0.515	0.525	13.10	13.30
aaa	0.007 REF		0.178 REF	
bbb	0.010 REF		0.254 REF	
ccc	0.015 REF		0.381 REF	

- STYLE 1:
- PIN 1. DRAIN
 - PIN 2. GATE
 - PIN 3. SOURCE

**CASE 465B-03
ISSUE D
NI-880
MRF5S19130HR3**

PRODUCT DOCUMENTATION

Refer to the following documents to aid your design process.

Application Notes

- AN1955: Thermal Measurement Methodology of RF Power Amplifiers

Engineering Bulletins

- EB212: Using Data Sheet Impedances for RF LDMOS Devices

REVISION HISTORY

The following table summarizes revisions to this document.

Revision	Date	Description
3	Nov. 2008	<ul style="list-style-type: none"> • Data sheet revised to reflect part status change, p. 1, including use of applicable overlay. • Modified data sheet to reflect RF Test Reduction described in Product and Process Change Notification number, PCN12779, p. 1, 2 • Updated Part Numbers in Table 5, Component Designations and Values, to latest RoHS compliant part numbers, p. 3 • Added Product Documentation and Revision History, p. 9

How to Reach Us:

Home Page:

www.freescale.com

Web Support:

<http://www.freescale.com/support>

USA/Europe or Locations Not Listed:

Freescale Semiconductor, Inc.
Technical Information Center, EL516
2100 East Elliot Road
Tempe, Arizona 85284
1-800-521-6274 or +1-480-768-2130
www.freescale.com/support

Europe, Middle East, and Africa:

Freescale Halbleiter Deutschland GmbH
Technical Information Center
Schatzbogen 7
81829 Muenchen, Germany
+44 1296 380 456 (English)
+46 8 52200080 (English)
+49 89 92103 559 (German)
+33 1 69 35 48 48 (French)
www.freescale.com/support

Japan:

Freescale Semiconductor Japan Ltd.
Headquarters
ARCO Tower 15F
1-8-1, Shimo-Meguro, Meguro-ku,
Tokyo 153-0064
Japan
0120 191014 or +81 3 5437 9125
support.japan@freescale.com

Asia/Pacific:

Freescale Semiconductor China Ltd.
Exchange Building 23F
No. 118 Jianguo Road
Chaoyang District
Beijing 100022
China
+86 10 5879 8000
support.asia@freescale.com

For Literature Requests Only:

Freescale Semiconductor Literature Distribution Center
P.O. Box 5405
Denver, Colorado 80217
1-800-441-2447 or +1-303-675-2140
Fax: +1-303-675-2150
LDCForFreescaleSemiconductor@hibbertgroup.com

Information in this document is provided solely to enable system and software implementers to use Freescale Semiconductor products. There are no express or implied copyright licenses granted hereunder to design or fabricate any integrated circuits or integrated circuits based on the information in this document.

Freescale Semiconductor reserves the right to make changes without further notice to any products herein. Freescale Semiconductor makes no warranty, representation or guarantee regarding the suitability of its products for any particular purpose, nor does Freescale Semiconductor assume any liability arising out of the application or use of any product or circuit, and specifically disclaims any and all liability, including without limitation consequential or incidental damages. "Typical" parameters that may be provided in Freescale Semiconductor data sheets and/or specifications can and do vary in different applications and actual performance may vary over time. All operating parameters, including "Typicals", must be validated for each customer application by customer's technical experts. Freescale Semiconductor does not convey any license under its patent rights nor the rights of others. Freescale Semiconductor products are not designed, intended, or authorized for use as components in systems intended for surgical implant into the body, or other applications intended to support or sustain life, or for any other application in which the failure of the Freescale Semiconductor product could create a situation where personal injury or death may occur. Should Buyer purchase or use Freescale Semiconductor products for any such unintended or unauthorized application, Buyer shall indemnify and hold Freescale Semiconductor and its officers, employees, subsidiaries, affiliates, and distributors harmless against all claims, costs, damages, and expenses, and reasonable attorney fees arising out of, directly or indirectly, any claim of personal injury or death associated with such unintended or unauthorized use, even if such claim alleges that Freescale Semiconductor was negligent regarding the design or manufacture of the part.

Freescale™ and the Freescale logo are trademarks of Freescale Semiconductor, Inc. All other product or service names are the property of their respective owners.

© Freescale Semiconductor, Inc. 2008. All rights reserved.