

RF Power Field Effect Transistors

N-Channel Enhancement-Mode Lateral MOSFETs

Designed for W-CDMA and LTE base station applications with frequencies from 2620 to 2690 MHz. Can be used in Class AB and Class C for all typical cellular base station modulation formats.

- Typical Single-Carrier W-CDMA Performance: $V_{DD} = 28$ Volts, $I_{DQ} = 900$ mA, $P_{out} = 28$ Watts Avg., IQ Magnitude Clipping, Channel Bandwidth = 3.84 MHz, Input Signal PAR = 7.5 dB @ 0.01% Probability on CCDF.

Frequency	G_{ps} (dB)	η_D (%)	Output PAR (dB)	ACPR (dBc)
2620 MHz	15.5	31.5	6.3	-38.0
2655 MHz	15.5	31.1	6.3	-37.3
2690 MHz	15.6	31.1	6.2	-36.7

- Capable of Handling 10:1 VSWR, @ 32 Vdc, 2655 MHz, 135 Watts CW Output Power (3 dB Input Overdrive from Rated P_{out})
- Typical P_{out} @ 1 dB Compression Point \approx 110 Watts CW

Features

- 100% PAR Tested for Guaranteed Output Power Capability
- Characterized with Series Equivalent Large-Signal Impedance Parameters and Common Source S-Parameters
- Internally Matched for Ease of Use
- Integrated ESD Protection
- Greater Negative Gate-Source Voltage Range for Improved Class C Operation
- Designed for Digital Predistortion Error Correction Systems
- Optimized for Doherty Applications
- RoHS Compliant
- In Tape and Reel. R3 Suffix = 250 Units per 56 mm, 13 inch Reel.

MRF8S26120HR3
MRF8S26120HSR3

2620-2690 MHz, 28 W AVG., 28 V
W-CDMA, LTE
LATERAL N-CHANNEL
RF POWER MOSFETs

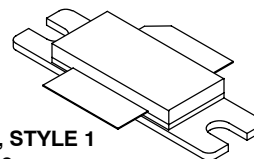

CASE 465-06, STYLE 1
NI-780
MRF8S26120HR3

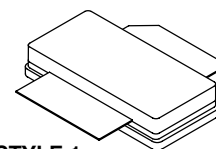

CASE 465A-06, STYLE 1
NI-780S
MRF8S26120HSR3

Table 1. Maximum Ratings

Rating	Symbol	Value	Unit
Drain-Source Voltage	V_{DSS}	-0.5, +65	Vdc
Gate-Source Voltage	V_{GS}	-6.0, +10	Vdc
Operating Voltage	V_{DD}	32, +0	Vdc
Storage Temperature Range	T_{stg}	-65 to +150	$^{\circ}C$
Case Operating Temperature	T_C	150	$^{\circ}C$
Operating Junction Temperature (1,2)	T_J	225	$^{\circ}C$
CW Operation @ $T_C = 25^{\circ}C$ Derate above 25 $^{\circ}C$	CW	141 0.78	W W/ $^{\circ}C$

Table 2. Thermal Characteristics

Characteristic	Symbol	Value (2,3)	Unit
Thermal Resistance, Junction to Case Case Temperature 72 $^{\circ}C$, 28 W CW, 28 Vdc, $I_{DQ} = 900$ mA, 2690 MHz Case Temperature 85 $^{\circ}C$, 110 W CW(4), 28 Vdc, $I_{DQ} = 900$ mA, 2690 MHz	$R_{\theta JC}$	0.53 0.47	$^{\circ}C/W$

1. Continuous use at maximum temperature will affect MTTF.
2. MTTF calculator available at <http://www.freescale.com/rf>. Select Software & Tools/Development Tools/Calculators to access MTTF calculators by product.
3. Refer to AN1955, *Thermal Measurement Methodology of RF Power Amplifiers*. Go to <http://www.freescale.com/rf>. Select Documentation/Application Notes - AN1955.
4. Exceeds recommended operating conditions. See CW operation data in Maximum Ratings table.

Table 3. ESD Protection Characteristics

Test Methodology	Class
Human Body Model (per JESD22-A114)	2 (Minimum)
Machine Model (per EIA/JESD22-A115)	A (Minimum)
Charge Device Model (per JESD22-C101)	IV (Minimum)

Table 4. Electrical Characteristics ($T_A = 25^\circ\text{C}$ unless otherwise noted)

Characteristic	Symbol	Min	Typ	Max	Unit
----------------	--------	-----	-----	-----	------

Off Characteristics

Zero Gate Voltage Drain Leakage Current ($V_{DS} = 65\text{ Vdc}$, $V_{GS} = 0\text{ Vdc}$)	I_{DSS}	—	—	10	μAdc
Zero Gate Voltage Drain Leakage Current ($V_{DS} = 28\text{ Vdc}$, $V_{GS} = 0\text{ Vdc}$)	I_{DSS}	—	—	1	μAdc
Gate-Source Leakage Current ($V_{GS} = 5\text{ Vdc}$, $V_{DS} = 0\text{ Vdc}$)	I_{GSS}	—	—	1	μAdc

On Characteristics

Gate Threshold Voltage ($V_{DS} = 10\text{ Vdc}$, $I_D = 172\ \mu\text{Adc}$)	$V_{GS(th)}$	1.2	2.0	2.7	Vdc
Gate Quiescent Voltage ($V_{DD} = 28\text{ Vdc}$, $I_D = 900\text{ mA}$, Measured in Functional Test)	$V_{GS(Q)}$	1.5	2.6	3.0	Vdc
Drain-Source On-Voltage ($V_{GS} = 10\text{ Vdc}$, $I_D = 1.7\text{ Adc}$)	$V_{DS(on)}$	0.1	0.24	0.3	Vdc

Functional Tests ⁽¹⁾ (In Freescale Test Fixture, 50 ohm system) $V_{DD} = 28\text{ Vdc}$, $I_{DQ} = 900\text{ mA}$, $P_{out} = 28\text{ W Avg.}$, $f = 2690\text{ MHz}$, Single-Carrier W-CDMA, IQ Magnitude Clipping, Input Signal PAR = 7.5 dB @ 0.01% Probability on CCDF. ACPR measured in 3.84 MHz Channel Bandwidth @ $\pm 5\text{ MHz}$ Offset.

Power Gain	G_{ps}	14.5	15.6	17.5	dB
Drain Efficiency	η_D	28.0	31.1	—	%
Output Peak-to-Average Ratio @ 0.01% Probability on CCDF	PAR	5.7	6.2	—	dB
Adjacent Channel Power Ratio	ACPR	—	-36.7	-34.5	dBc
Input Return Loss	IRL	—	-14	-9	dB

Typical Broadband Performance (In Freescale Test Fixture, 50 ohm system) $V_{DD} = 28\text{ Vdc}$, $I_{DQ} = 900\text{ mA}$, $P_{out} = 28\text{ W Avg.}$, Single-Carrier W-CDMA, IQ Magnitude Clipping, Input Signal PAR = 7.5 dB @ 0.01% Probability on CCDF. ACPR measured in 3.84 MHz Channel Bandwidth @ $\pm 5\text{ MHz}$ Offset.

Frequency	G_{ps} (dB)	η_D (%)	Output PAR (dB)	ACPR (dBc)	IRL (dB)
2620 MHz	15.5	31.5	6.3	-38.0	-13
2655 MHz	15.5	31.1	6.3	-37.3	-14
2690 MHz	15.6	31.1	6.2	-36.7	-14

1. Part internally matched both on input and output.

(continued)

Table 4. Electrical Characteristics ($T_A = 25^\circ\text{C}$ unless otherwise noted) (continued)

Characteristic	Symbol	Min	Typ	Max	Unit
Typical Performances (In Freescale Test Fixture, 50 ohm system) $V_{DD} = 28\text{ Vdc}$, $I_{DQ} = 900\text{ mA}$, 2620–2690 MHz Bandwidth					
P_{out} @ 1 dB Compression Point, CW	P1dB	—	110	—	W
IMD Symmetry @ 80 W PEP, P_{out} where IMD Third Order Intermodulation $\cong 30\text{ dBc}$ (Delta IMD Third Order Intermodulation between Upper and Lower Sidebands > 2 dB)	IMD _{sym}	—	18	—	MHz
VBW Resonance Point (IMD Third Order Intermodulation Inflection Point)	VBW _{res}	—	65	—	MHz
Gain Flatness in 70 MHz Bandwidth @ $P_{out} = 28\text{ W Avg.}$	G _F	—	0.1	—	dB
Gain Variation over Temperature (-30°C to $+85^\circ\text{C}$)	ΔG	—	0.015	—	dB/ $^\circ\text{C}$
Output Power Variation over Temperature (-30°C to $+85^\circ\text{C}$) (1)	ΔP_{1dB}	—	0.007	—	dB/ $^\circ\text{C}$

1. Exceeds recommended operating conditions. See CW operation data in Maximum Ratings table.

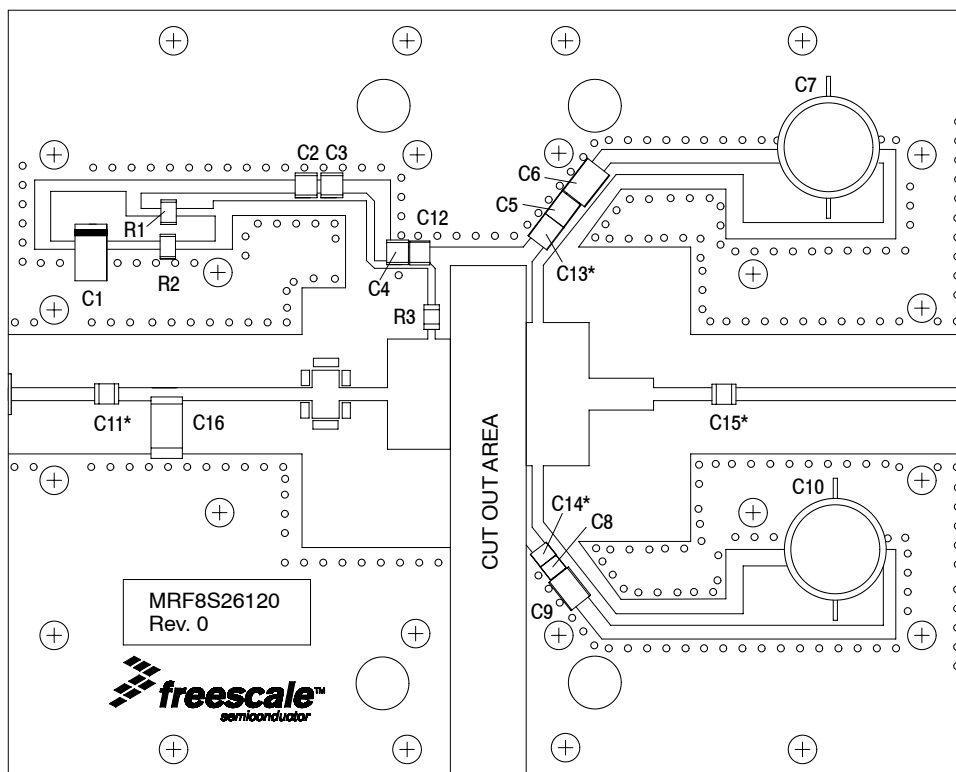

*C11, C13, C14, and C15 are mounted vertically.

Figure 1. MRF8S26120HR3(HSR3) Test Circuit Component Layout

Table 5. MRF8S26120HR3(HSR3) Test Circuit Component Designations and Values

Part	Description	Part Number	Manufacturer
C1	22 μ F, 35 V Tantalum Capacitor	T494X226K035AT	Kemet
C2	330 nF, 100 V Chip Capacitor	C3225X7R2A334KT	TDK
C3	15 nF, 100 V Chip Capacitor	C3225C0G2A153JT	TDK
C4, C5, C8	2.2 μ F, 100 V Chip Capacitors	C3225X7R2A225KT	TDK
C6, C9	22 μ F, 50 V Chip Capacitors	C5750JF1H226ZT	TDK
C7, C10	470 μ F, 63 V Electrolytic Capacitors	MCGPR63V477M13X26-RH	Multicomp
C11, C12, C13, C14, C15	27 pF Chip Capacitors	ATC800B270JT500XT	ATC
C16	0.8 pF Chip Capacitor	ATC100B0R8BT500XT	ATC
R1	1 k Ω , 1/4 W Chip Resistor	CRCW12061K00FKEA	Vishay
R2	10 k Ω , 1/4 W Chip Resistor	CRCW120610K0FKEA	Vishay
R3	7.5 Ω , 1/4 W Chip Resistor	CRCW12067R50FNEA	Vishay
PCB	0.030", $\epsilon_r = 3.5$	RF-35	Taconic

TYPICAL CHARACTERISTICS

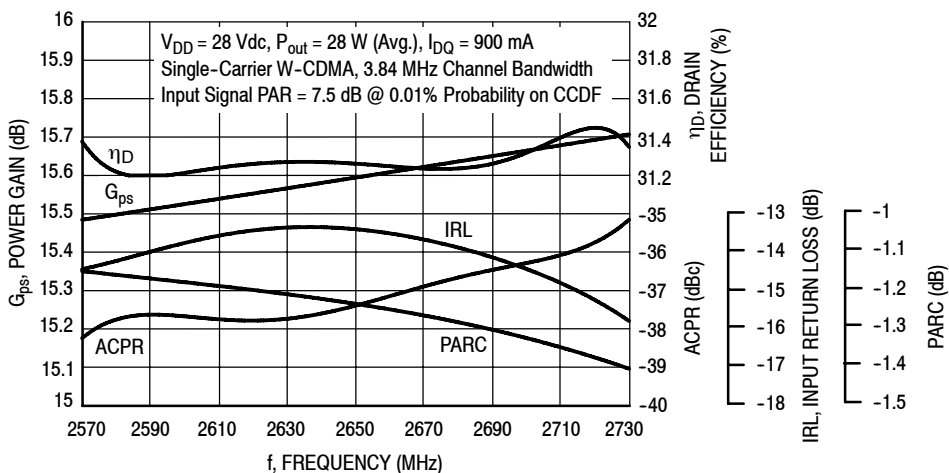

Figure 2. Output Peak-to-Average Ratio Compression (PARC) Broadband Performance @ P_{out} = 28 Watts Avg.

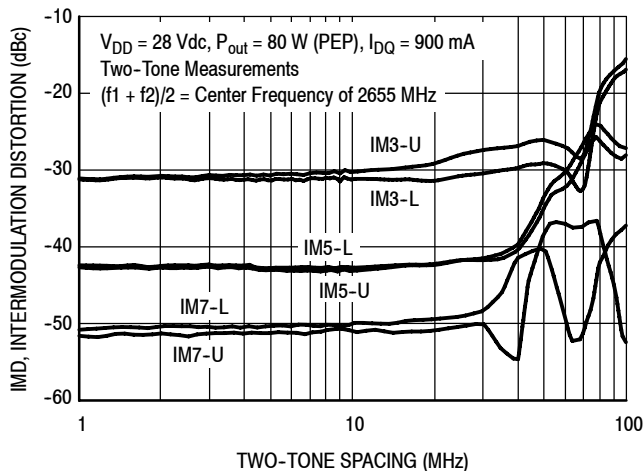

Figure 3. Intermodulation Distortion Products versus Two-Tone Spacing

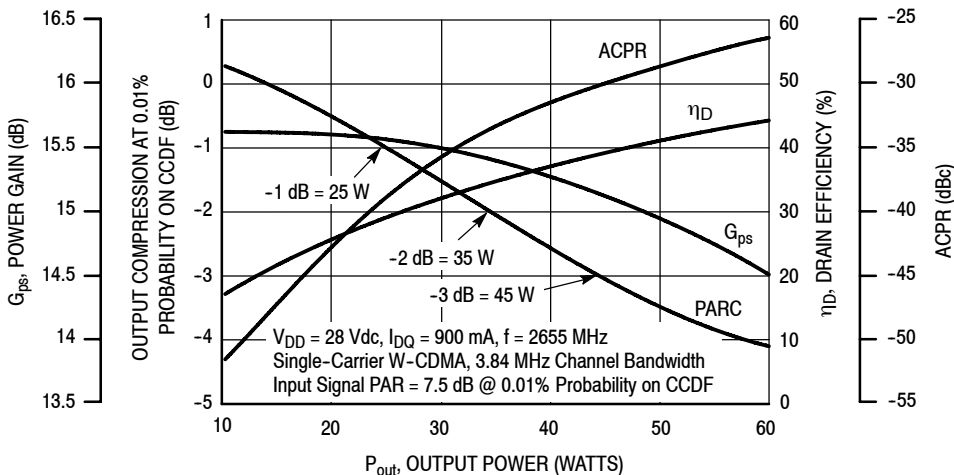

Figure 4. Output Peak-to-Average Ratio Compression (PARC) versus Output Power

TYPICAL CHARACTERISTICS

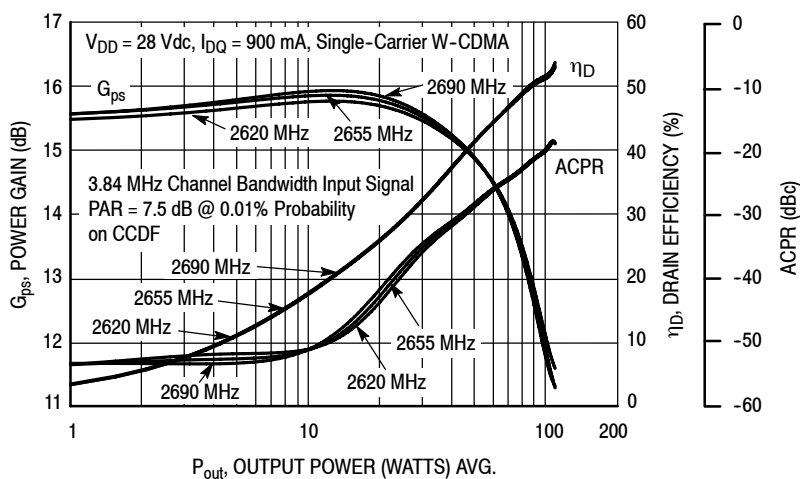

Figure 5. Single-Carrier W-CDMA Power Gain, Drain Efficiency and ACPR versus Output Power

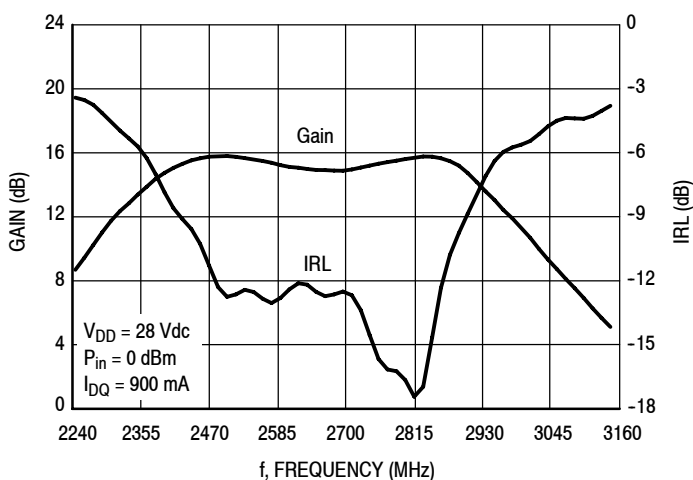

Figure 6. Broadband Frequency Response

W-CDMA TEST SIGNAL

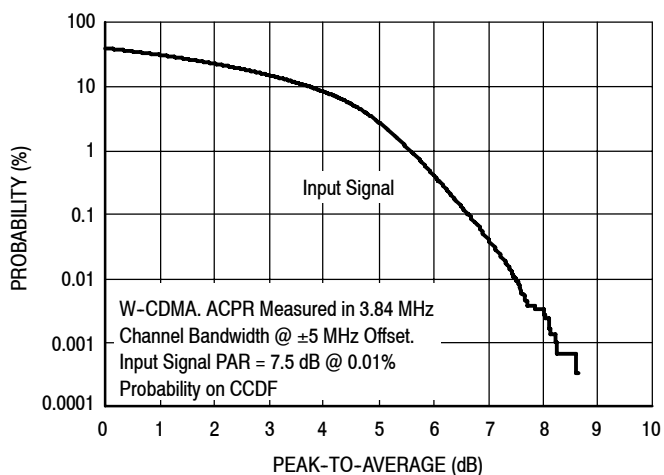

Figure 7. CCDF W-CDMA IQ Magnitude Clipping, Single-Carrier Test Signal

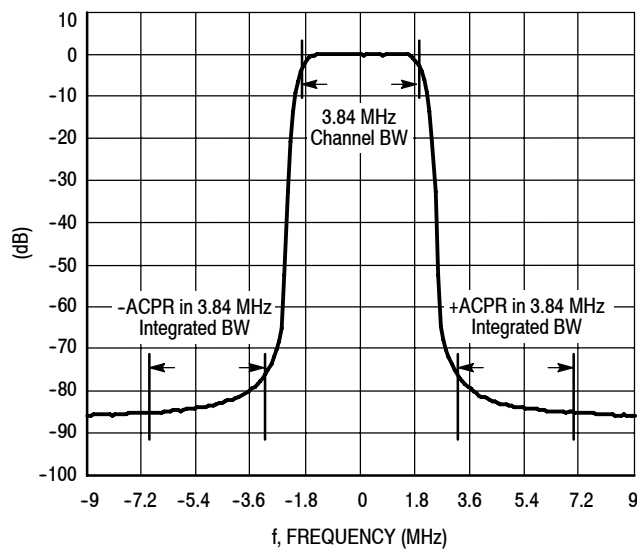

Figure 8. Single-Carrier W-CDMA Spectrum

$V_{DD} = 28 \text{ Vdc}$, $I_{DQ} = 900 \text{ mA}$, $P_{out} = 28 \text{ W Avg.}$

f MHz	Z_{source} Ω	Z_{load} Ω
2570	5.21 - j5.62	3.17 - j4.27
2590	5.26 - j5.33	3.15 - j4.20
2610	5.31 - j5.02	3.12 - j4.12
2630	5.35 - j4.71	3.10 - j4.04
2650	5.39 - j4.39	3.07 - j3.96
2670	5.46 - j4.05	3.06 - j3.88
2690	5.53 - j3.77	3.06 - j3.82
2710	5.57 - j3.47	3.05 - j3.77
2730	5.59 - j3.15	3.05 - j3.73

Z_{source} = Test circuit impedance as measured from gate to ground.

Z_{load} = Test circuit impedance as measured from drain to ground.

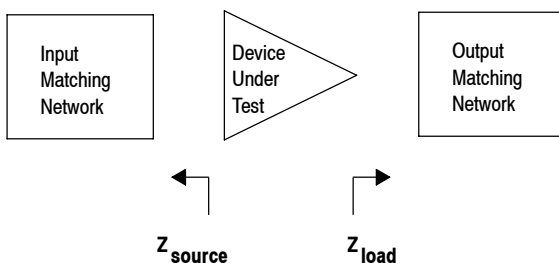
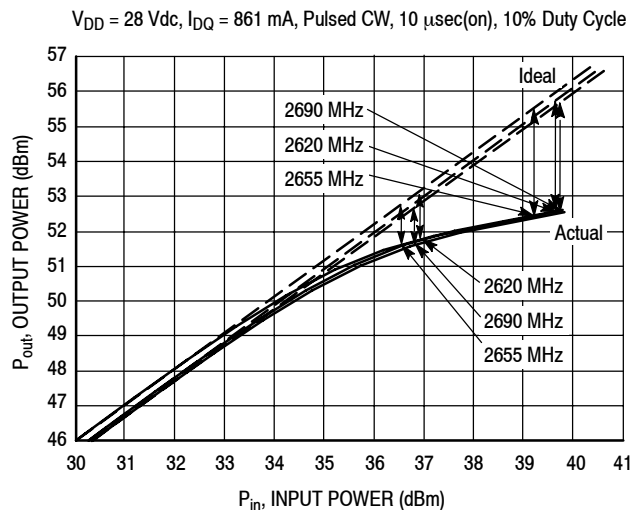

Figure 9. Series Equivalent Source and Load Impedance

ALTERNATIVE PEAK TUNE LOAD PULL CHARACTERISTICS



NOTE: Load Pull Test Fixture Tuned for Peak P1dB Output Power @ 28 V

f (MHz)	P1dB		P3dB	
	Watts	dBm	Watts	dBm
2620	149	51.7	182	52.6
2655	144	51.6	177	52.5
2690	146	51.6	179	52.5

Test Impedances per Compression Level

f (MHz)		Z_{source} Ω	Z_{load} Ω
2620	P1dB	5.83 - j7.00	1.44 - j2.87
2655	P1dB	7.87 - j6.87	1.72 - j3.15
2690	P1dB	9.46 - j5.13	1.52 - j3.20

Figure 10. Pulsed CW Output Power versus Input Power @ 28 V

PACKAGE DIMENSIONS

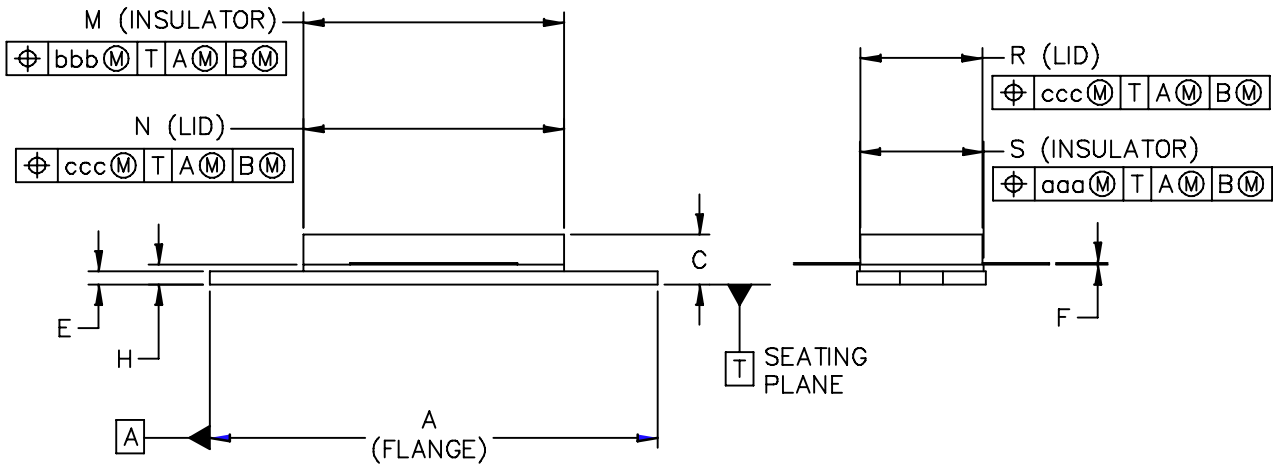
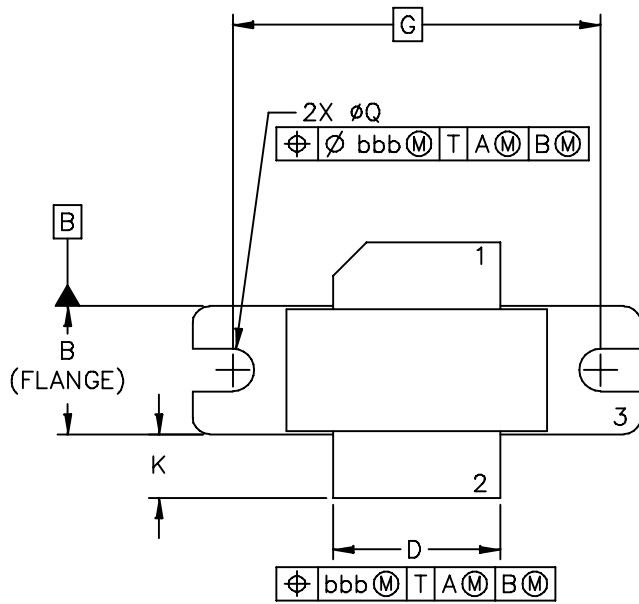

© FREESCALE SEMICONDUCTOR, INC. ALL RIGHTS RESERVED.	MECHANICAL OUTLINE	PRINT VERSION NOT TO SCALE	
TITLE: NI-780	DOCUMENT NO: 98ASB15607C	REV: G	
	CASE NUMBER: 465-06	31 MAR 2005	
	STANDARD: NON-JEDEC		

NOTES:

1. DIMENSIONING AND TOLERANCING PER ANSI Y14.5M-1994.
2. CONTROLLING DIMENSION: INCH.
3. DELETED
4. DIMENSION H IS MEASURED .030 (.762) AWAY FROM PACKAGE BODY.

STYLE 1:

- PIN 1. DRAIN
 2. GATE
 3. SOURCE

DIM	INCH		MILLIMETER		DIM	INCH		MILLIMETER	
	MIN	MAX	MIN	MAX		MIN	MAX	MIN	MAX
A	1.335	1.345	33.91	34.16	R	.365	.375	9.27	9.53
B	.380	.390	9.65	9.91	S	.365	.375	9.27	9.52
C	.125	.170	3.18	4.32	aaa	—	.005	—	0.127
D	.495	.505	12.57	12.83	bbb	—	.010	—	0.254
E	.035	.045	0.89	1.14	ccc	—	.015	—	0.381
F	.003	.006	0.08	0.15	—	—	—	—	—
G	1.100 BSC		27.94 BSC		—	—	—	—	—
H	.057	.067	1.45	1.7	—	—	—	—	—
K	.170	.210	4.32	5.33	—	—	—	—	—
M	.774	.786	19.66	19.96	—	—	—	—	—
N	.772	.788	19.6	20	—	—	—	—	—
Q	∅.118	∅.138	∅3	∅3.51	—	—	—	—	—

© FREESCALE SEMICONDUCTOR, INC. ALL RIGHTS RESERVED.	MECHANICAL OUTLINE	PRINT VERSION NOT TO SCALE
TITLE: <div style="text-align: center; font-size: 1.2em;">NI-780</div>	DOCUMENT NO: 98ASB15607C CASE NUMBER: 465-06 STANDARD: NON-JEDEC	REV: G 31 MAR 2005

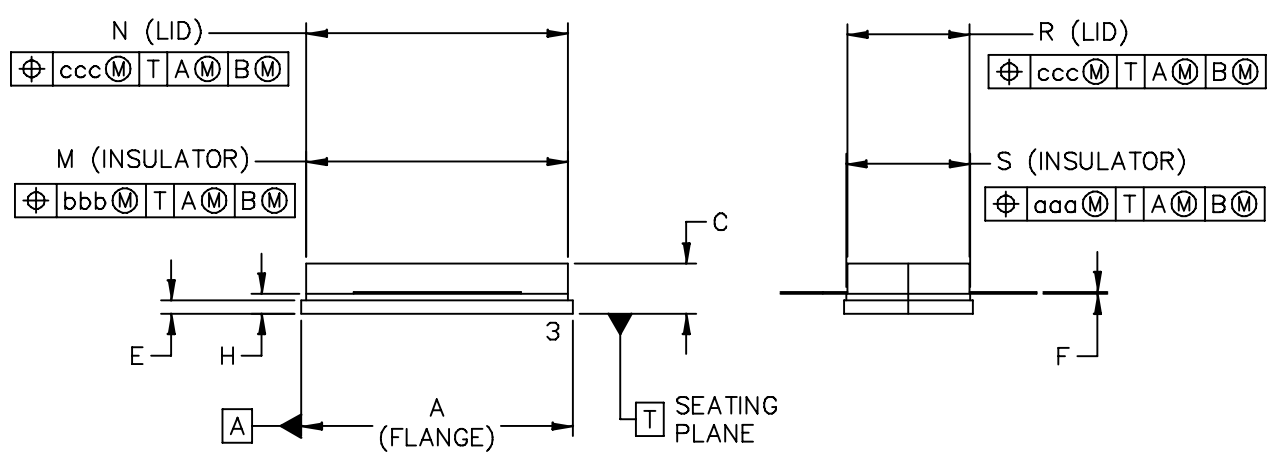
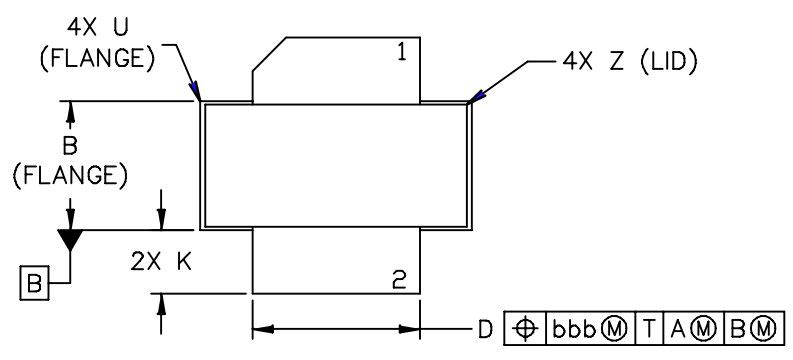

© FREESCALE SEMICONDUCTOR, INC. ALL RIGHTS RESERVED.	MECHANICAL OUTLINE	PRINT VERSION NOT TO SCALE
TITLE: NI-780S	DOCUMENT NO: 98ASB16718C	REV: H
	CASE NUMBER: 465A-06	31 MAR 2005
	STANDARD: NON-JEDEC	

NOTES:

1. DIMENSIONING AND TOLERANCING PER ANSI Y14.5M-1994.
2. CONTROLLING DIMENSION: INCH.
3. DELETED
4. DIMENSION H IS MEASURED .030 (0.762) AWAY FROM PACKAGE BODY.

STYLE 1:

- PIN 1. DRAIN
2. GATE
3. SOURCE

DIM	INCH		MILLIMETER		DIM	INCH		MILLIMETER	
	MIN	MAX	MIN	MAX		MIN	MAX	MIN	MAX
A	.805	-.815	20.45	20.7	U	-.040	-	-	1.02
B	.380	-.390	9.65	9.91	Z	-.030	-	-	0.76
C	.125	-.170	3.18	4.32	aaa	-.005	-	-	0.127
D	.495	-.505	12.57	12.83	bbb	-.010	-	-	0.254
E	.035	-.045	0.89	1.14	ccc	-.015	-	-	0.381
F	.003	-.006	0.08	0.15	-	-	-	-	-
H	.057	-.067	1.45	1.7	-	-	-	-	-
K	.170	-.210	4.32	5.33	-	-	-	-	-
M	.774	-.786	19.61	20.02	-	-	-	-	-
N	.772	-.788	19.61	20.02	-	-	-	-	-
R	.365	-.375	9.27	9.53	-	-	-	-	-
S	.365	-.375	9.27	9.52	-	-	-	-	-

© FREESCALE SEMICONDUCTOR, INC. ALL RIGHTS RESERVED.		MECHANICAL OUTLINE		PRINT VERSION NOT TO SCALE	
TITLE: NI-780S		DOCUMENT NO: 98ASB16718C		REV: H	
		CASE NUMBER: 465A-06		31 MAR 2005	
		STANDARD: NON-JEDEC			

PRODUCT DOCUMENTATION AND SOFTWARE

Refer to the following documents, tools and software to aid your design process.

Application Notes

- AN1955: Thermal Measurement Methodology of RF Power Amplifiers

Engineering Bulletins

- EB212: Using Data Sheet Impedances for RF LDMOS Devices

Software

- Electromigration MTTF Calculator
- RF High Power Model
- .s2p File

For Software, do a Part Number search at <http://www.freescale.com>, and select the “Part Number” link. Go to the Software & Tools tab on the part’s Product Summary page to download the respective tool.

REVISION HISTORY

The following table summarizes revisions to this document.

Revision	Date	Description
0	June 2010	• Initial Release of Data Sheet

How to Reach Us:

Home Page:

www.freescale.com

Web Support:

<http://www.freescale.com/support>

USA/Europe or Locations Not Listed:

Freescale Semiconductor, Inc.
Technical Information Center, EL516
2100 East Elliot Road
Tempe, Arizona 85284
1-800-521-6274 or +1-480-768-2130
www.freescale.com/support

Europe, Middle East, and Africa:

Freescale Halbleiter Deutschland GmbH
Technical Information Center
Schatzbogen 7
81829 Muenchen, Germany
+44 1296 380 456 (English)
+46 8 52200080 (English)
+49 89 92103 559 (German)
+33 1 69 35 48 48 (French)
www.freescale.com/support

Japan:

Freescale Semiconductor Japan Ltd.
Headquarters
ARCO Tower 15F
1-8-1, Shimo-Meguro, Meguro-ku,
Tokyo 153-0064
Japan
0120 191014 or +81 3 5437 9125
support.japan@freescale.com

Asia/Pacific:

Freescale Semiconductor China Ltd.
Exchange Building 23F
No. 118 Jianguo Road
Chaoyang District
Beijing 100022
China
+86 10 5879 8000
support.asia@freescale.com

For Literature Requests Only:

Freescale Semiconductor Literature Distribution Center
1-800-441-2447 or +1-303-675-2140
Fax: +1-303-675-2150
LDCForFreescaleSemiconductor@hibbertgroup.com

Information in this document is provided solely to enable system and software implementers to use Freescale Semiconductor products. There are no express or implied copyright licenses granted hereunder to design or fabricate any integrated circuits or integrated circuits based on the information in this document.

Freescale Semiconductor reserves the right to make changes without further notice to any products herein. Freescale Semiconductor makes no warranty, representation or guarantee regarding the suitability of its products for any particular purpose, nor does Freescale Semiconductor assume any liability arising out of the application or use of any product or circuit, and specifically disclaims any and all liability, including without limitation consequential or incidental damages. "Typical" parameters that may be provided in Freescale Semiconductor data sheets and/or specifications can and do vary in different applications and actual performance may vary over time. All operating parameters, including "Typicals", must be validated for each customer application by customer's technical experts. Freescale Semiconductor does not convey any license under its patent rights nor the rights of others. Freescale Semiconductor products are not designed, intended, or authorized for use as components in systems intended for surgical implant into the body, or other applications intended to support or sustain life, or for any other application in which the failure of the Freescale Semiconductor product could create a situation where personal injury or death may occur. Should Buyer purchase or use Freescale Semiconductor products for any such unintended or unauthorized application, Buyer shall indemnify and hold Freescale Semiconductor and its officers, employees, subsidiaries, affiliates, and distributors harmless against all claims, costs, damages, and expenses, and reasonable attorney fees arising out of, directly or indirectly, any claim of personal injury or death associated with such unintended or unauthorized use, even if such claim alleges that Freescale Semiconductor was negligent regarding the design or manufacture of the part.

Freescale™ and the Freescale logo are trademarks of Freescale Semiconductor, Inc. All other product or service names are the property of their respective owners.

© Freescale Semiconductor, Inc. 2010. All rights reserved.