



RF Power LDMOS Transistors

N-Channel Enhancement-Mode Lateral MOSFETs

These high power transistors are designed for use in UHF TV broadcast applications. The devices have an integrated input matching network for better power distribution and are ideal for use in both analog and digital TV transmitters.

DBV-T Broadband Class AB Performance: $V_{DD} = 50$ Vdc, $I_{DQ} = 1400$ mA, Channel Bandwidth = 8 MHz, Input Signal PAR = 9.5 dB @ 0.01% Probability on CCDF.

Signal Type	P_{out} (W)	f (MHz)	G_{ps} (dB)	η_D (%)	Output PAR (dB)
DVB-T (8k OFDM)	140 Avg.	474	20.2	29.7	8.9
		610	20.7	34.5	8.2
		810	20.0	34.0	8.4

Load Mismatch/Ruggedness

Frequency (MHz)	Signal Type	VSWR	P_{out} (W)	Test Voltage	Result
860	DVB-T (8k OFDM)	20:1 at all Phase Angles	125 (3 dB Overdrive)	50	No Device Degradation

Features

- Excellent thermal characteristics
- High gain for reduced PA size
- High efficiency for Class AB and Doherty operations
- Integrated input matching and unmatched output
- Extended negative gate-source voltage range of -6 Vdc to $+10$ Vdc

MRFE8VP8600H
MRFE8VP8600HS

470–860 MHz, 140 W AVG., 50 V
RF POWER LDMOS TRANSISTORS

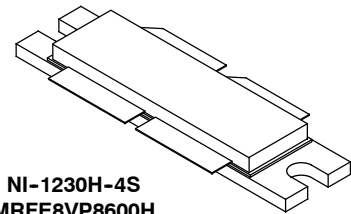

NI-1230H-4S
 MRFE8VP8600H

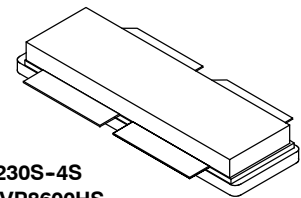

NI-1230S-4S
 MRFE8VP8600HS

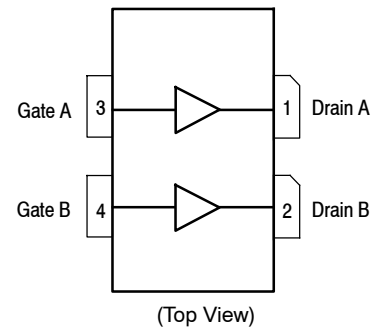

Note: The backside of the package is the source terminal for the transistor.

Figure 1. Pin Connections

Table 1. Maximum Ratings

Rating	Symbol	Value	Unit
Drain-Source Voltage	V_{DS}	-0.5, +115	Vdc
Gate-Source Voltage	V_{GS}	-6.0, +10	Vdc
Storage Temperature Range	T_{stg}	-65 to +150	°C
Case Operating Temperature Range	T_C	-40 to +150	°C
Operating Junction Temperature Range (1)	T_J	-40 to +225	°C
Total Device Dissipation @ $T_C = 25^\circ\text{C}$ Derate above 25°C	P_D	1250 6.25	W W/°C

Table 2. Thermal Characteristics

Characteristic	Symbol	Value (2,3)	Unit
Thermal Resistance, Junction to Case Case Temperature 99°C, 125 W DVB-T (8k OFDM), 50 Vdc, $I_{DQ} = 1400$ mA, 860 MHz	$R_{\theta JC}$	0.16	°C/W

Table 3. ESD Protection Characteristics

Test Methodology	Class
Human Body Model (per JESD22-A114)	2, passes 2500 V
Machine Model (per EIA/JESD22-A115)	B, passes 250 V
Charge Device Model (per JESD22-C101)	IV, passes 2000 V

Table 4. Electrical Characteristics ($T_A = 25^\circ\text{C}$ unless otherwise noted)

Characteristic	Symbol	Min	Typ	Max	Unit
----------------	--------	-----	-----	-----	------

Off Characteristics (4)

Gate-Source Leakage Current ($V_{GS} = 5$ Vdc, $V_{DS} = 0$ Vdc)	I_{GSS}	—	—	1	μAdc
Drain-Source Breakdown Voltage ($V_{GS} = 0$ Vdc, $I_D = 10$ μAdc)	$V_{(BR)DSS}$	115	118	—	Vdc
Zero Gate Voltage Drain Leakage Current ($V_{DS} = 50$ Vdc, $V_{GS} = 0$ Vdc)	I_{DSS}	—	—	5	μAdc
Zero Gate Voltage Drain Leakage Current ($V_{DS} = 115$ Vdc, $V_{GS} = 0$ Vdc)	I_{DSS}	—	—	20	μAdc

On Characteristics

Gate Threshold Voltage (4) ($V_{DS} = 10$ Vdc, $I_D = 925$ μAdc)	$V_{GS(th)}$	1.3	2.1	2.3	Vdc
Gate Quiescent Voltage (5) ($V_{DD} = 50$ Vdc, $I_D = 1400$ mAdc, Measured in Functional Test)	$V_{GS(Q)}$	1.8	2.4	2.8	Vdc
Drain-Source On-Voltage (4) ($V_{GS} = 10$ Vdc, $I_D = 2.8$ Adc)	$V_{DS(on)}$	0.1	0.3	0.5	Vdc
Forward Transconductance ($V_{DS} = 10$ Vdc, $I_D = 17$ Adc)	g_{fs}	—	19.4	—	S

Dynamic Characteristics (4)

Reverse Transfer Capacitance (6) ($V_{DS} = 50$ Vdc \pm 30 mV(rms)ac @ 1 MHz, $V_{GS} = 0$ Vdc)	C_{rss}	—	1.62	—	pF
Output Capacitance (6) ($V_{DS} = 50$ Vdc \pm 30 mV(rms)ac @ 1 MHz, $V_{GS} = 0$ Vdc)	C_{oss}	—	71.2	—	pF
Input Capacitance (7) ($V_{DS} = 50$ Vdc, $V_{GS} = 0$ Vdc \pm 30 mV(rms)ac @ 1 MHz)	C_{iss}	—	452	—	pF

1. Continuous use at maximum temperature will affect MTTF.
2. MTTF calculator available at <http://www.nxp.com/RF/calculators>.
3. Refer to AN1955, *Thermal Measurement Methodology of RF Power Amplifiers*. Go to <http://www.nxp.com/RF> and search for AN1955.
4. Each side of device measured separately.
5. Measurement made with device in push-pull configuration.
6. Part internally input matched.
7. Die capacitance value without internal matching.

(continued)

Table 4. Electrical Characteristics ($T_A = 25^\circ\text{C}$ unless otherwise noted) (continued)

Characteristic	Symbol	Min	Typ	Max	Unit
Functional Tests ⁽¹⁾ (In NXP Narrowband Test Fixture, 50 ohm system) $V_{DD} = 50\text{ Vdc}$, $I_{DQ} = 1400\text{ mA}$, $P_{out} = 125\text{ W Avg.}$, $f = 860\text{ MHz}$, DVB-T (8k OFDM) Single Channel. ACPR measured in 7.61 MHz Signal Bandwidth @ $\pm 4\text{ MHz}$ Offset with an Integration Bandwidth of 4 kHz.					
Power Gain	G_{ps}	20.6	21.0	23.6	dB
Drain Efficiency	η_D	28.0	30.0	—	%
Adjacent Channel Power Ratio	ACPR	—	-61.0	-59.4	dBc
Input Return Loss	IRL	—	-12	-9	dB

Typical DVB-T (8k OFDM) Performance (In NXP Narrowband Test Fixture, 50 ohm system) $V_{DD} = 50\text{ Vdc}$, $I_{DQ} = 1400\text{ mA}$, $f = 860\text{ MHz}$, DVB-T (8k OFDM) Single Channel.

Output Peak-to-Average Ratio @ 0.01% Probability on CCDF, $P_{out} = 125\text{ W Avg.}$	PAR	—	7.8	—	dB
Load Mismatch VSWR 20:1 at all Phase Angles, 3 dB Overdrive from Rated P_{out} (125 W Avg.)	Ψ	No Degradation in Output Power			

Table 5. Ordering Information

Device	Tape and Reel Information	Package
MRFE8VP8600HR5	R5 Suffix = 50 Units, 56 mm Tape Width, 13-inch Reel	NI-1230H-4S
MRFE8VP8600HSR5		NI-1230S-4S

1. Measurement made with device in push-pull configuration.

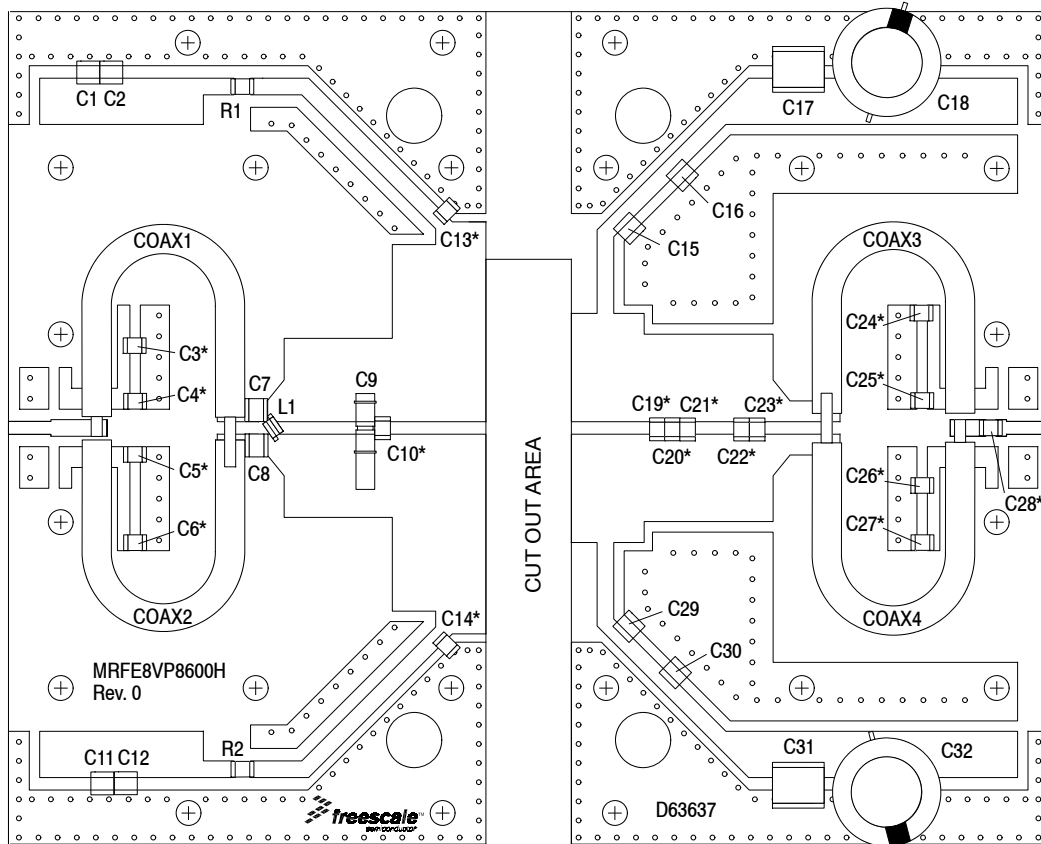

*C3, C4, C5, C6, C10, C13, C14, C19, C20, C21, C22, C23, C24, C25, C26, C27, and C28 are mounted vertically.

Figure 2. MRFE8VP8600H Test Circuit Component Layout — 860 MHz, DVB-T (8k OFDM)

Table 6. MRFE8VP8600H Test Circuit Component Designations and Values — 860 MHz, DVB-T (8k OFDM)

Part	Description	Part Number	Manufacturer
C1, C11	10 μ F Chip Capacitors	GRM32ER61H106KA12L	Murata
C2, C12	2.2 μ F Chip Capacitors	C3225X7R1H225K250AB	TDK
C3, C4, C5, C6	30 pF Chip Capacitors	ATC100B300JT500XT	ATC
C7, C8	24 pF Chip Capacitors	ATC100B240JT500XT	ATC
C9	0.8–8.0 pF Variable Capacitor	27291SL	Johanson Components
C10	12 pF Chip Capacitor	ATC100B120JT500XT	ATC
C13, C14	8.2 pF Chip Capacitors	ATC100B8R2CT500XT	ATC
C15, C29	2.2 μ F Chip Capacitors	C3225X7R2A225K230AB	TDK
C16, C25, C26, C28, C30	100 pF Chip Capacitors	ATC100B101JT500XT	ATC
C17, C31	4.7 μ F Chip Capacitors	C575X7R2A475K230KA	TDK
C18, C32	470 μ F, 63 V Electrolytic Capacitors	MCGPR63V477M13X26-RH	Multicomp
C19	7.5 pF Chip Capacitor	ATC100B7R5CT500XT	ATC
C20	3.3 pF Chip Capacitor	ATC100B3R3CT500XT	ATC
C21	3.0 pF Chip Capacitor	ATC100B3R0BT500XT	ATC
C22	3.9 pF Chip Capacitor	ATC100B3R9CT500XT	ATC
C23	5.1 pF Chip Capacitor	ATC100B5R1CT500XT	ATC
C24, C27	1000 pF Chip Capacitors	ATC100B102JT50XT	ATC
Coax1, 2	25 Ω Semi Rigid Coax, 2.0" Shield Length	UT-141C-25	Micro-Coax
Coax3, 4	25 Ω Semi Rigid Coax, 2.2" Shield Length	UT-141C-25	Micro-Coax
L1	2.5 nH, 1 Turn Inductor	A01TKLC	Coilcraft
R1, R2	10 Ω , 1/4 W Chip Resistors	CRCW120610R0JNEA	Vishay
PCB	Rogers RO4350B, 0.030", $\epsilon_r = 3.66$	D63637	MTL

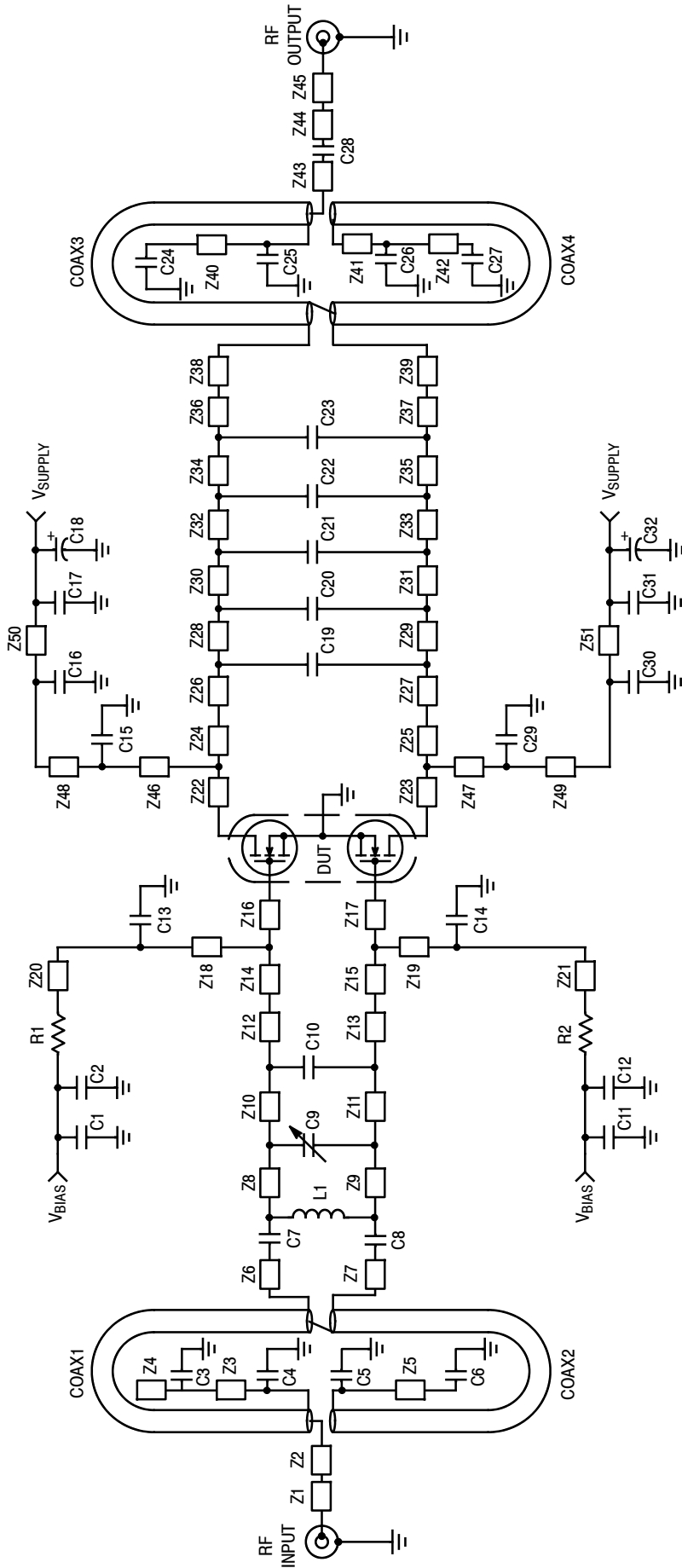

Figure 3. MRFE8VP8600H Test Circuit Schematic — 860 MHz DVB-T (8k OFDM)

Table 7. MRFE8VP8600H Test Circuit Schematic — 860 MHz DVB-T (8k OFDM)

Microstrip	Description
Z1	0.204" x 0.062" Microstrip
Z2	0.245" x 0.080" Microstrip
Z3, Z4	0.220" x 0.060" Microstrip
Z5	0.410" x 0.062" Microstrip
Z6, Z7	0.019" x 0.100" Microstrip
Z8, Z9	0.341" x 0.400" Microstrip
Z10, Z11	0.083" x 0.400" Microstrip
Z12, Z13	0.065" x 0.400" Microstrip
Z14, Z15	0.208" x 0.850" Microstrip
Z16, Z17	0.242" x 0.960" Microstrip

*Line length includes microstrip bends

Microstrip	Description
Z18, Z19	0.115" x 0.080" Microstrip
Z20*, Z21*	1.026" x 0.080" Microstrip
Z22, Z23	0.164" x 0.520" Microstrip
Z24, Z25	0.186" x 0.520" Microstrip
Z26, Z27	0.015" x 0.420" Microstrip
Z28, Z29	0.072" x 0.420" Microstrip
Z30, Z31	0.072" x 0.420" Microstrip
Z32, Z33	0.275" x 0.420" Microstrip
Z34, Z35	0.072" x 0.420" Microstrip
Z36, Z37	0.074" x 0.420" Microstrip

Microstrip	Description
Z38, Z39	0.211" x 0.100" Microstrip
Z40	0.389" x 0.060" Microstrip
Z41	0.155" x 0.060" Microstrip
Z42	0.280" x 0.060" Microstrip
Z43	0.070" x 0.080" Microstrip
Z44	0.018" x 0.080" Microstrip
Z45	0.204" x 0.062" Microstrip
Z46, Z47	0.358" x 0.080" Microstrip
Z48*, Z49*	0.297" x 0.080" Microstrip
Z50, Z51	0.371" x 0.080" Microstrip

TYPICAL CHARACTERISTICS — 860 MHz

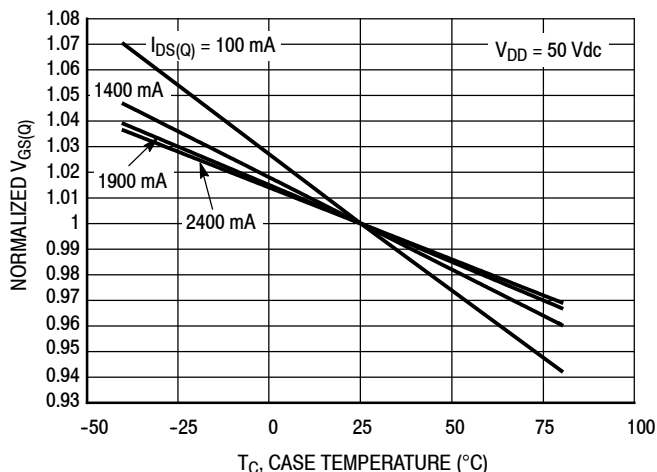

Figure 4. Normalized V_{GS} versus Quiescent Current and Case Temperature

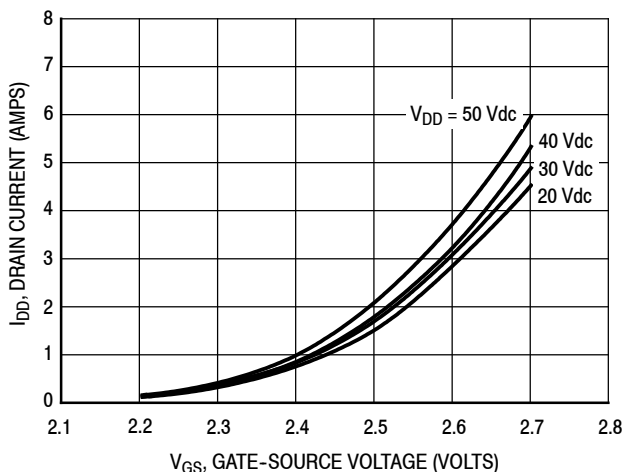
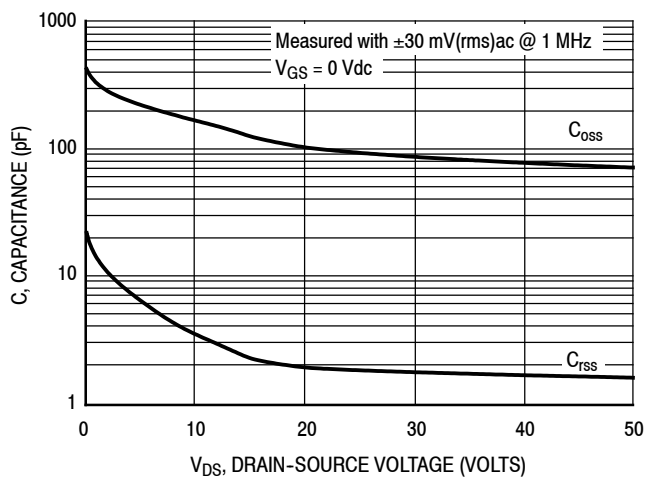

Figure 5. Drain Current versus Gate-Source Voltage



Note: Each side of device measured separately.

Figure 6. Capacitance versus Drain-Source Voltage

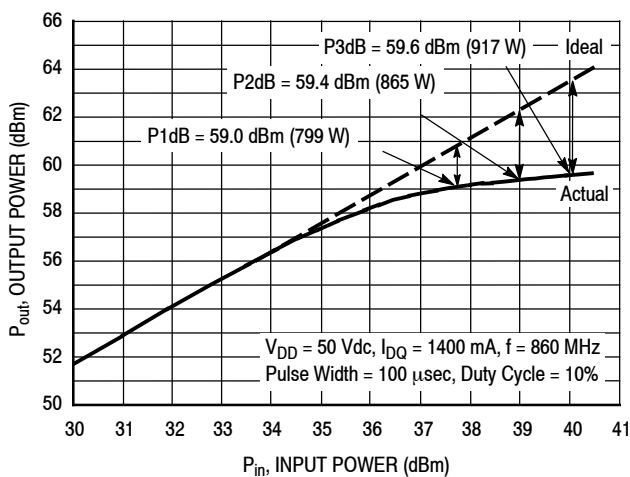

Figure 7. Pulse CW Output Power versus Input Power

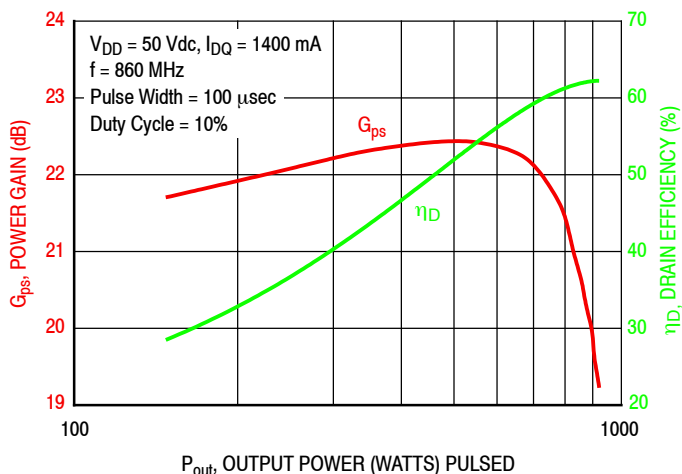

Figure 8. Pulse Power Gain and Drain Efficiency versus Output Power

TYPICAL CHARACTERISTICS — DVB-T (8k OFDM)

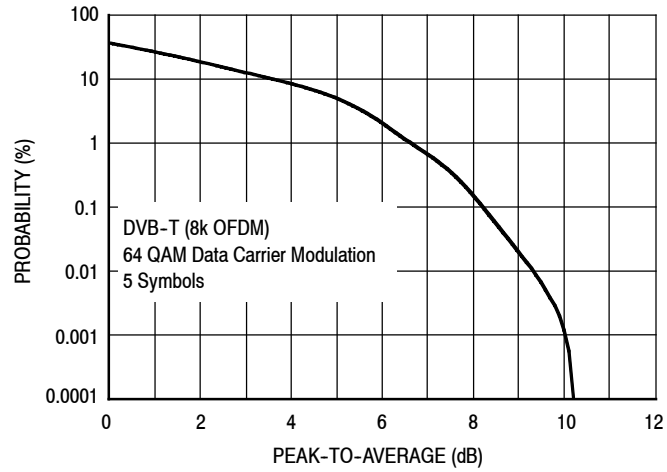

Figure 9. Source Peak-to-Average DVB-T (8k OFDM)

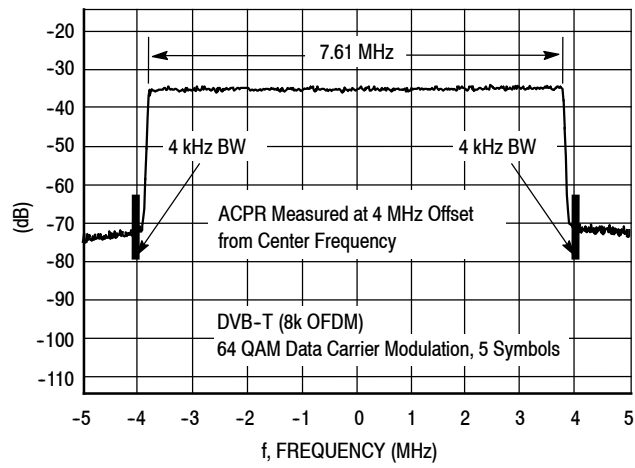
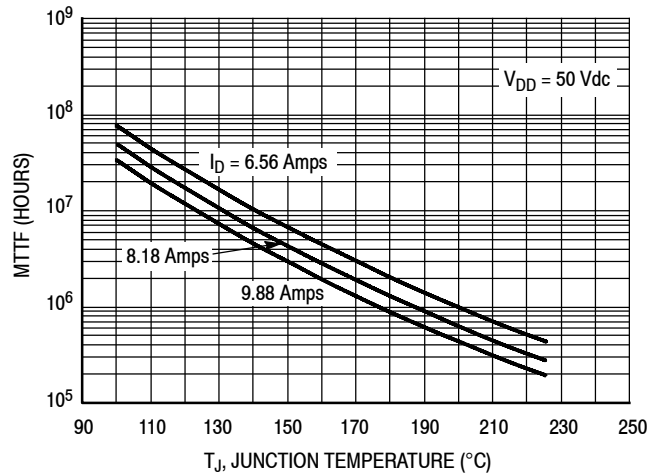

Figure 10. DVB-T (8k OFDM) Spectrum

TYPICAL CHARACTERISTICS



Note: MTTF value represents the total cumulative operating time under indicated test conditions.

MTTF calculator available at <http://www.nxp.com/RF/calculators>.

Figure 11. MTTF versus Junction Temperature - CW

f MHz	Z _{source} Ω	Z _{load} Ω
860	0.85 - j0.90	4.0 + j1.1

Z_{source} = Test circuit impedance as measured from gate to gate, balanced configuration.

Z_{load} = Test circuit impedance as measured from drain to drain, balanced configuration.

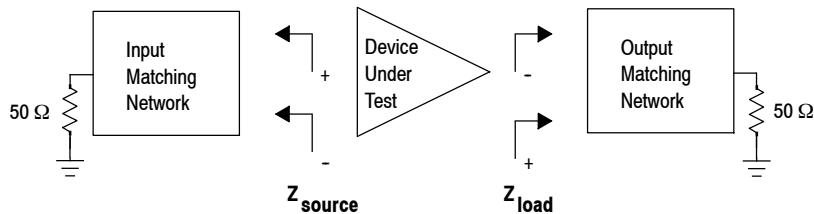
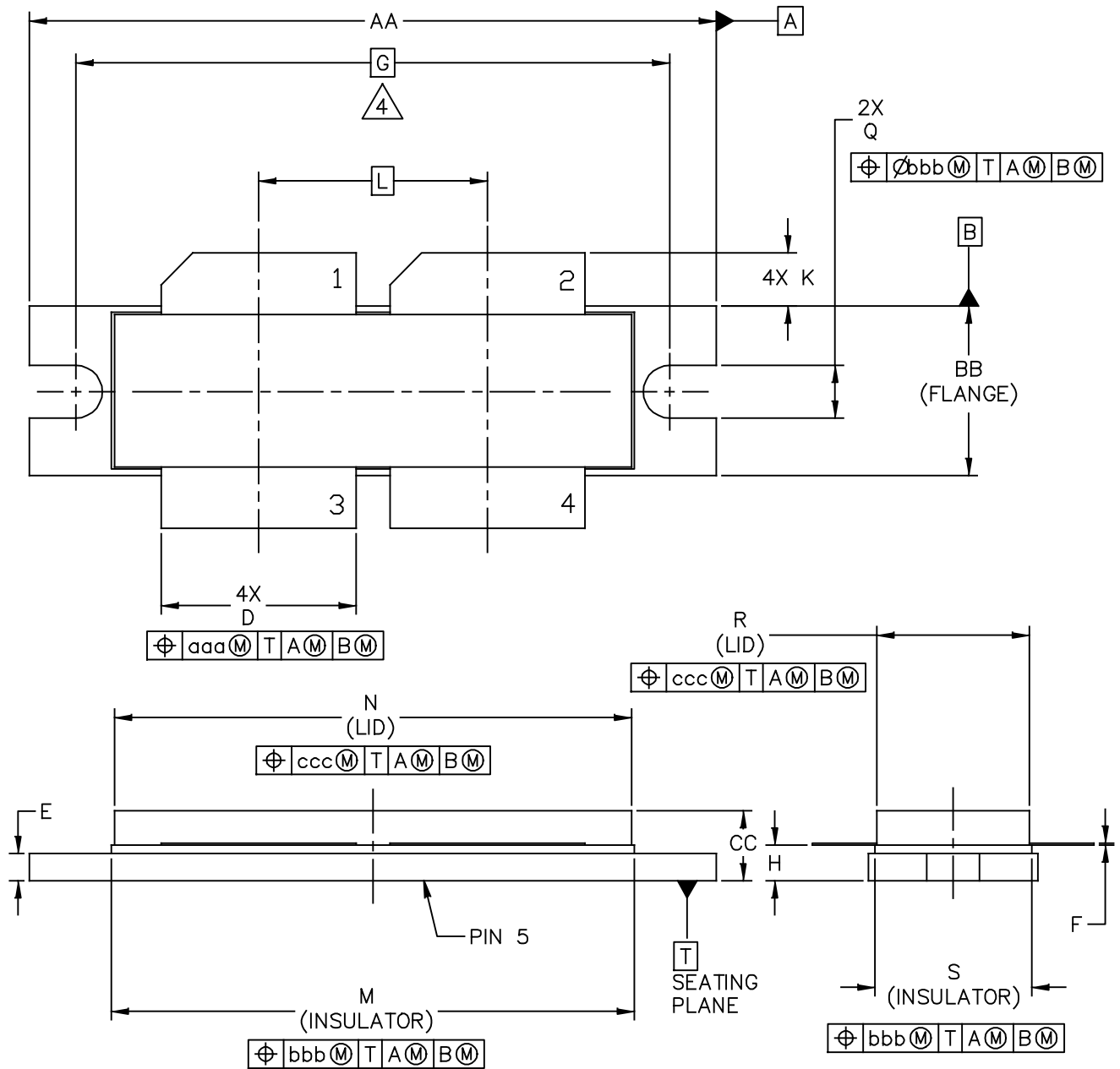

Figure 12. Series Equivalent Source and Load Impedance

PACKAGE DIMENSIONS



© NXP SEMICONDUCTORS N.V. ALL RIGHTS RESERVED	MECHANICAL OUTLINE	PRINT VERSION NOT TO SCALE
TITLE: NI-1230-4H	DOCUMENT NO: 98ASB16977C STANDARD: NON-JEDEC SOT1787-1	REV: G 03 MAR 2016

MRFE8VP8600H MRFE8VP8600HS

NOTES:

1. INTERPRET DIMENSIONS AND TOLERANCES PER ASME Y14.5M-1994.
2. CONTROLLING DIMENSION: INCH
3. DIMENSION H IS MEASURED .030 INCH (0.762 MM) AWAY FROM PACKAGE BODY.

4.  RECOMMENDED BOLT CENTER DIMENSION OF 1.52 INCH (38.61 MM) BASED ON M3 SCREW.

DIM	INCH		MILLIMETER		DIM	INCH		MILLIMETER	
	MIN	MAX	MIN	MAX		MIN	MAX	MIN	MAX
AA	1.615	1.625	41.02	41.28	N	1.218	1.242	30.94	31.55
BB	.395	.405	10.03	10.29	Q	.120	.130	3.05	3.30
CC	.170	.190	4.32	4.83	R	.355	.365	9.02	9.27
D	.455	.465	11.56	11.81	S	.365	.375	9.27	9.53
E	.062	.066	1.57	1.68					
F	.004	.007	0.10	0.18					
G	1.400 BSC		35.56 BSC		aaa	.013		0.33	
H	.082	.090	2.08	2.29	bbb	.010		0.25	
K	.117	.137	2.97	3.48	ccc	.020		0.51	
L	.540 BSC		13.72 BSC						
M	1.219	1.241	30.96	31.52					
© NXP SEMICONDUCTORS N.V. ALL RIGHTS RESERVED			MECHANICAL OUTLINE			PRINT VERSION NOT TO SCALE			
TITLE: NI-1230-4H					DOCUMENT NO: 98ASB16977C REV: G				
					STANDARD: NON-JEDEC				
					SOT1787-1			03 MAR 2016	

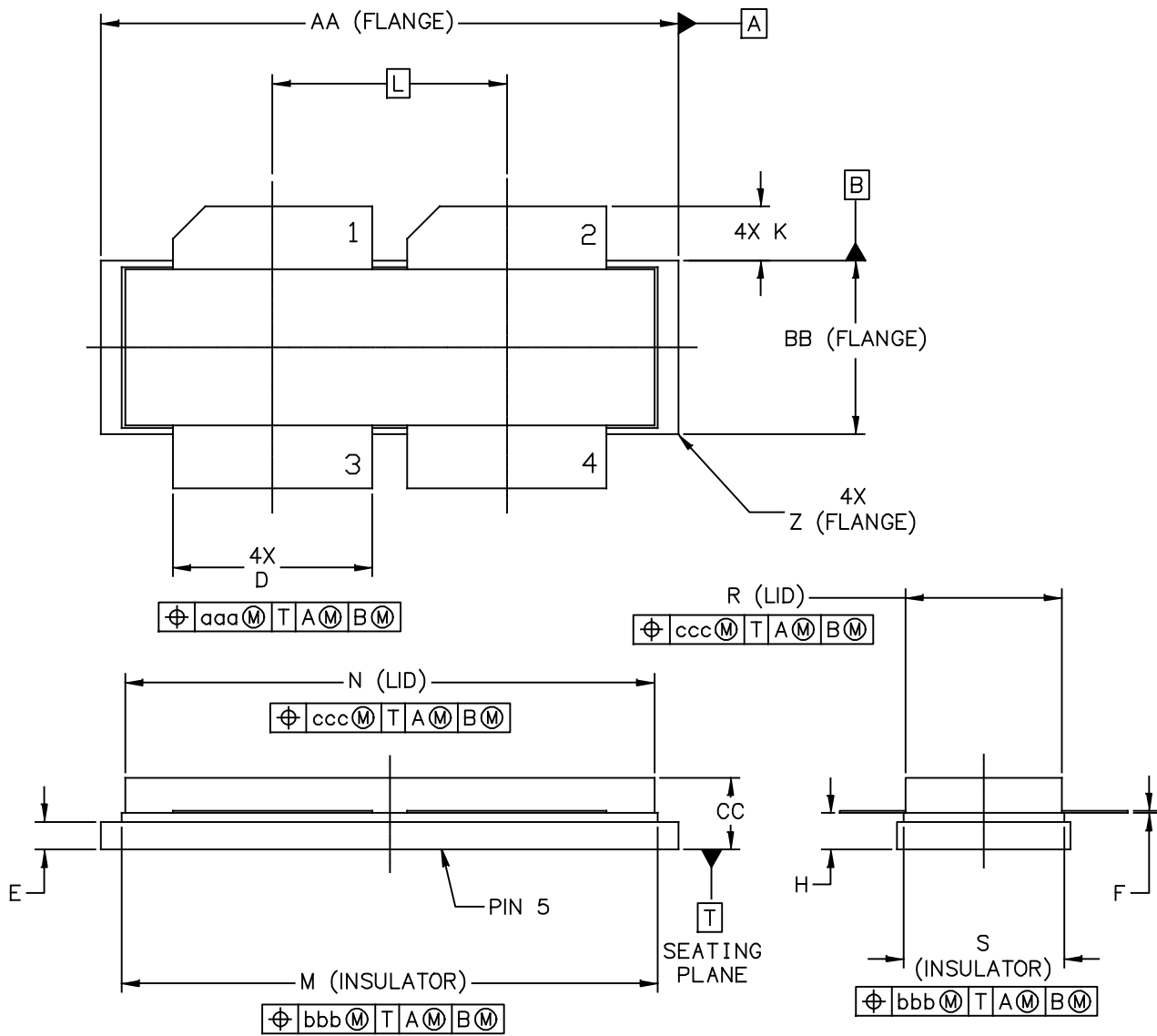

© NXP SEMICONDUCTORS N. V. ALL RIGHTS RESERVED	MECHANICAL OUTLINE	PRINT VERSION NOT TO SCALE
TITLE: NI-1230-4S	DOCUMENT NO: 98ARB18247C STANDARD: NON-JEDEC SOT1829-1	REV: H 19 FEB 2016

NOTES:

1. INTERPRET DIMENSIONS AND TOLERANCES PER ASME Y14.5M-1994.
2. CONTROLLING DIMENSION: INCH
3. DIMENSION H IS MEASURED .030 INCH (0.762 MM) AWAY FROM PACKAGE BODY

DIM	INCHES		MILLIMETERS		DIM	INCHES		MILLIMETERS	
	MIN	MAX	MIN	MAX		MIN	MAX	MIN	MAX
AA	1.265	1.275	32.13	32.39	R	.355	.365	9.02	9.27
BB	.395	.405	10.03	10.29	S	.365	.375	9.27	9.53
CC	.170	.190	4.32	4.83	Z	R.000	R.040	R0.00	R1.02
D	.455	.465	11.56	11.81					
E	.062	.066	1.57	1.68	aaa	.013		0.33	
F	.004	.007	0.10	0.18	bbb	.010		0.25	
H	.082	.090	2.08	2.29	ccc	.020		0.51	
K	.117	.137	2.97	3.48					
L	.540 BSC		13.72 BSC						
M	1.219	1.241	30.96	31.52					
N	1.218	1.242	30.94	31.55					
© NXP SEMICONDUCTORS N.V. ALL RIGHTS RESERVED			MECHANICAL OUTLINE			PRINT VERSION NOT TO SCALE			
TITLE: NI-1230-4S					DOCUMENT NO: 98ARB18247C		REV: H		
					STANDARD: NON-JEDEC				
					SOT1829-1		19 FEB 2016		

PRODUCT DOCUMENTATION, SOFTWARE AND TOOLS

Refer to the following resources to aid your design process.

Application Notes

- AN1908: Solder Reflow Attach Method for High Power RF Devices in Air Cavity Packages
- AN1955: Thermal Measurement Methodology of RF Power Amplifiers

Engineering Bulletins

- EB212: Using Data Sheet Impedances for RF LDMOS Devices

Software

- Electromigration MTTF Calculator
- RF High Power Model
- .s2p File

Development Tools

- Printed Circuit Boards

To Download Resources Specific to a Given Part Number:

1. Go to <http://www.nxp.com/RF>
2. Search by part number
3. Click part number link
4. Choose the desired resource from the drop down menu

REVISION HISTORY

The following table summarizes revisions to this document.

Revision	Date	Description
0	July 2015	<ul style="list-style-type: none">• Initial release of data sheet
1	Aug. 2017	<ul style="list-style-type: none">• Added part number MRFE8VP8600HS, pp. 1, 3• Added NI-1230S-4S package isometric, p. 1, and Mechanical Outline, pp. 11-12

How to Reach Us:

Home Page:
nxp.com

Web Support:
nxp.com/support

Information in this document is provided solely to enable system and software implementers to use NXP products. There are no express or implied copyright licenses granted hereunder to design or fabricate any integrated circuits based on the information in this document. NXP reserves the right to make changes without further notice to any products herein.

NXP makes no warranty, representation, or guarantee regarding the suitability of its products for any particular purpose, nor does NXP assume any liability arising out of the application or use of any product or circuit, and specifically disclaims any and all liability, including without limitation consequential or incidental damages. "Typical" parameters that may be provided in NXP data sheets and/or specifications can and do vary in different applications, and actual performance may vary over time. All operating parameters, including "typicals," must be validated for each customer application by customer's technical experts. NXP does not convey any license under its patent rights nor the rights of others. NXP sells products pursuant to standard terms and conditions of sale, which can be found at the following address: nxp.com/SalesTermsandConditions.

NXP, the NXP logo, Freescale, and the Freescale logo are trademarks of NXP B.V. All other product or service names are the property of their respective owners.
© 2017 NXP B.V.

