

NX5P2924B

Logic controlled high-side power switch

Rev. 1 — 24 February 2014

Product data sheet

1. General description

The NX5P2924B is a high-side load switch which features a low ON resistance N-channel MOSFET with controlled slew rate that supports 2.5 A of continuous current. Designed for operation from 0.8 V to 5.5 V, it is used in power domain isolation applications to reduce power dissipation and extend battery life. The enable logic includes integrated logic level translation making the device compatible with lower voltage processors and controllers. The NX5P2924B is ideal for portable, battery operated applications due to low ground current.

2. Features and benefits

- Wide supply voltage range from 0.8 V to 5.5 V
- Very low ON resistance:
 - ◆ 14 mΩ (typical) at a supply voltage of 1.2 V
 - ◆ 14 mΩ (typical) at a supply voltage of 1.8 V
- High noise immunity
- High current handling capability (2.5 A continuous current)
- Turn-on slew rate limiting
- ESD protection:
 - ◆ HBM JESD22-A114F Class 3A exceeds 4000 V
 - ◆ CDM AEC-Q100-011 revision B exceeds 1000 V
- Specified from -40 °C to +85 °C

3. Applications

- Cell phone
- Digital cameras and audio devices
- Portable and battery-powered equipment



4. Ordering information

Table 1. Ordering information

Type number	Package			Version
	Temperature range	Name	Description	
NX5P2924BUK	-40 °C to +85 °C	WLCSP6	wafer level chip-scale package; 6 bumps; 0.87 x 1.37 x 0.5 mm	NX5P2924B

5. Marking

Table 2. Marking codes

Type number	Marking code
NX5P2924BUK	4B

6. Functional diagram

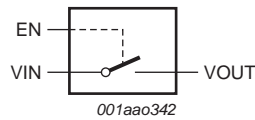

Fig 1. Logic symbol

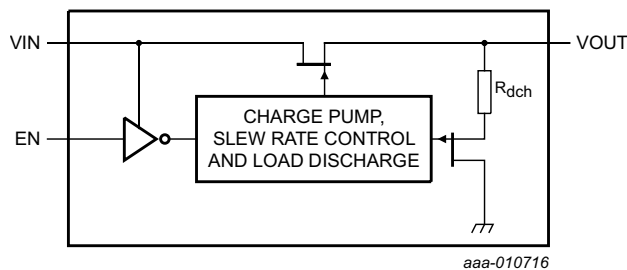
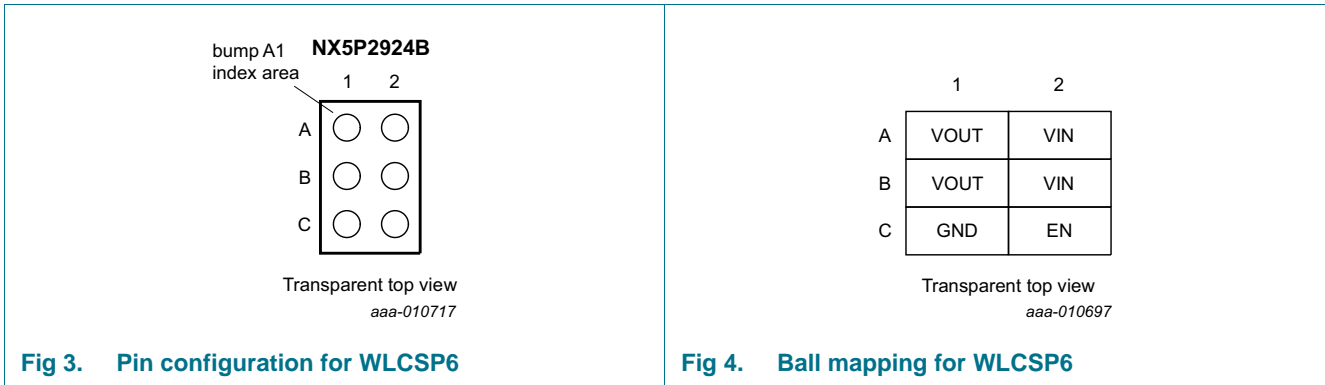

Fig 2. Logic diagram

7. Pinning information

7.1 Pinning



7.2 Pin description

Table 3. Pin description

Symbol	Pin	Description
VIN	A2, B2	input voltage
GND	C1	ground (0 V)
EN	C2	enable input (active HIGH)
VOUT	A1, B1	output voltage

8. Functional description

Table 4. Function table^[1]

Input EN	Switch
L	switch OFF
H	switch ON

[1] H = HIGH voltage level; L = LOW voltage level.

9. Limiting values

Table 5. Limiting values

In accordance with the Absolute Maximum Rating System (IEC 60134). Voltages are referenced to GND (ground = 0 V).

Symbol	Parameter	Conditions	Min	Max	Unit
V _I	input voltage	input EN	[1] -0.5	+6.0	V
		input VIN	[2] -0.5	+6.0	V
V _{SW}	switch voltage	output VOUT	[2] -0.5	V _{I(VIN)}	V
I _{IK}	input clamping current	input EN: V _{I(EN)} < -0.5 V	-50	-	mA
I _{SK}	switch clamping current	input VIN: V _{I(VIN)} < -0.5 V	-50	-	mA
		output VOUT: V _{O(VOUT)} < -0.5 V	-50	-	mA
		output VOUT: V _{O(VOUT)} > V _{I(VIN)} + 0.5 V	-	50	mA
I _{SW}	switch current	V _{SW} > -0.5 V	-	±2500	mA
T _{j(max)}	maximum junction temperature		-40	+125	°C
T _{stg}	storage temperature		-65	+150	°C
P _{tot}	total power dissipation		[3] -	470	mW

[1] The minimum input voltage rating may be exceeded if the input current rating is observed.

[2] The minimum and maximum switch voltage ratings may be exceeded if the switch clamping current rating is observed.

[3] The (absolute) maximum power dissipation depends on the junction temperature T_j. Higher power dissipation is allowed with lower ambient temperatures. The conditions to determine the specified values are T_{amb} = 85 °C and the use of a two layer PCB.

10. Recommended operating conditions

Table 6. Recommended operating conditions

Symbol	Parameter	Conditions	Min	Max	Unit
V _I	input voltage		0.8	5.5	V
T _{amb}	ambient temperature		-40	+85	°C

11. Thermal characteristics

Table 7. Thermal characteristics

Symbol	Parameter	Conditions	Typ	Unit
$R_{th(j-a)}$	thermal resistance from junction to ambient		[1] 139	K/W

[1] $R_{th(j-a)}$ is dependent upon board layout. To minimize $R_{th(j-a)}$, ensure that all pins have a solid connection to larger copper layer areas. In multi-layer PCBs, the second layer should be used to create a large heat spreader area below the device. Avoid using solder-stop varnish under the device.

12. Static characteristics

Table 8. Static characteristics

$V_{I(VIN)}$ = 1.0 V to 5.5 V, unless otherwise specified; Voltages are referenced to GND (ground = 0 V).

Symbol	Parameter	Conditions	$T_{amb} = 25\text{ °C}$			$T_{amb} = -40\text{ °C to }+85\text{ °C}$		Unit
			Min	Typ[1]	Max	Min	Max	
V_{IH}	HIGH-level input voltage	EN input; $V_{I(VIN)} = 0.8\text{ V}$	-	0.7	-	-	-	V
		EN input; $V_{I(VIN)} = 1.0\text{ V to }1.2\text{ V}$	0.9	-	-	0.9	-	V
		EN input; $V_{I(VIN)} = 1.2\text{ V to }2.5\text{ V}$	1.2	-	-	1.2	-	V
		EN input; $V_{I(VIN)} = 2.5\text{ V to }5.5\text{ V}$	1.2	-	-	1.2	-	V
V_{IL}	LOW-level input voltage	EN input; $V_{I(VIN)} = 0.8\text{ V}$	-	0.25	-	-	-	V
		EN input; $V_{I(VIN)} = 1.0\text{ V to }1.2\text{ V}$	-	-	0.3	-	0.3	V
		EN input; $V_{I(VIN)} = 1.2\text{ V to }2.5\text{ V}$	-	-	0.4	-	0.4	V
		EN input; $V_{I(VIN)} = 2.5\text{ V to }5.5\text{ V}$	-	-	0.6	-	0.6	V
I_I	input leakage current	EN input; $V_{I(EN)} = 0.9\text{ V to }5.5\text{ V}$	-	-	-	-	0.1	μA
R_{dch}	discharge resistance	VOUT output; $V_{I(VIN)} = 0.8\text{ V}$	-	4.00	-	-	-	k Ω
		VOUT output; $V_{I(VIN)} = 1.0\text{ V}$	-	1.40	-	-	-	k Ω
		VOUT output; $V_{I(VIN)} = 1.2\text{ V}$	-	1.30	-	-	-	k Ω
		VOUT output; $V_{I(VIN)} = 1.8\text{ V}$	-	1.27	1.50	-	-	k Ω
		VOUT output; $V_{I(VIN)} = 3.3\text{ V}$	-	1.25	1.50	-	-	k Ω
		VOUT output; $V_{I(VIN)} = 5.5\text{ V}$	-	1.25	1.50	-	-	k Ω

Table 8. Static characteristics ...continued $V_{I(VIN)} = 1.0\text{ V to }5.5\text{ V}$, unless otherwise specified; Voltages are referenced to GND (ground = 0 V). ...continued

Symbol	Parameter	Conditions	$T_{amb} = 25\text{ °C}$			$T_{amb} = -40\text{ °C to }+85\text{ °C}$		Unit
			Min	Typ ^[1]	Max	Min	Max	
$I_{(VIN)}$	supply current	VOUT open						
		EN = HIGH; $V_{I(VIN)} = 1.0\text{ V}$; see Figure 5 and Figure 6	-	25	-	-	35	μA
		EN = HIGH; $V_{I(VIN)} = 1.8\text{ V}$; see Figure 5 and Figure 6	-	30	-	-	50	μA
		EN = HIGH; $V_{I(VIN)} = 3.6\text{ V}$; see Figure 5 and Figure 6	-	45	-	-	65	μA
		EN = HIGH; $V_{I(VIN)} = 5.5\text{ V}$; see Figure 5 and Figure 6	-	75	-	-	105	μA
		EN = LOW; $V_{I(VIN)} = 1.0\text{ V}$; see Figure 7 and Figure 8	-	0.1	-	-	0.8	μA
		EN = LOW; $V_{I(VIN)} = 1.8\text{ V}$; see Figure 7 and Figure 8	-	0.1	-	-	1.0	μA
		EN = LOW; $V_{I(VIN)} = 3.6\text{ V}$; see Figure 7 and Figure 8	-	0.1	-	-	1.2	μA
$I_{S(OFF)}$	OFF-state leakage current	EN = LOW; $V_{I(VIN)} = 1.8\text{ V}$; $V_{I(VOUT)} = 0\text{ V}$; see Figure 9 and Figure 10	-	-0.5	-	-3.5	-	μA
		EN = LOW; $V_{I(VIN)} = 3.6\text{ V}$; $V_{I(VOUT)} = 0\text{ V}$; see Figure 9 and Figure 10	-	-0.5	-	-5.0	-	μA
		EN = LOW; $V_{I(VIN)} = 5.5\text{ V}$; $V_{I(VOUT)} = 0\text{ V}$; see Figure 9 and Figure 10	-	-0.5	-	-7.5	-	μA
C_I	input capacitance	EN	-	3	-	-	-	pF
$C_{S(ON)}$	ON-state capacitance	VIN; VOUT	-	-	0.5	-	0.5	nF

[1] All typical values are measured at $V_{I(VIN)} = 3.6\text{ V}$ and $T_{amb} = 25\text{ °C}$ unless otherwise specified.

12.1 Graphs

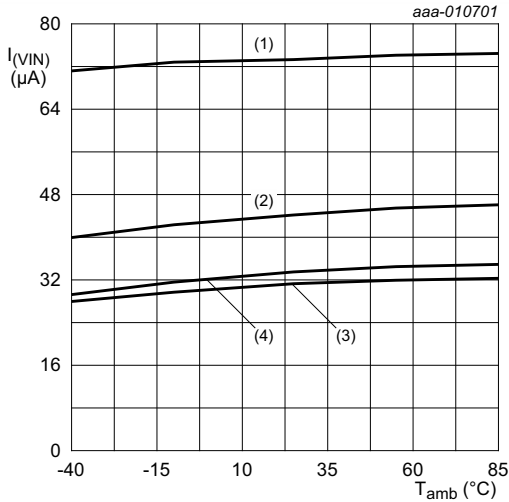

- $V_{I(EN)} = V_{I(VIN)}$
- (1) $V_{I(VIN)} = 5.5 \text{ V.}$
 - (2) $V_{I(VIN)} = 3.6 \text{ V.}$
 - (3) $V_{I(VIN)} = 1.8 \text{ V.}$
 - (4) $V_{I(VIN)} = 1.0 \text{ V.}$

Fig 5. Typical supply current versus temperature

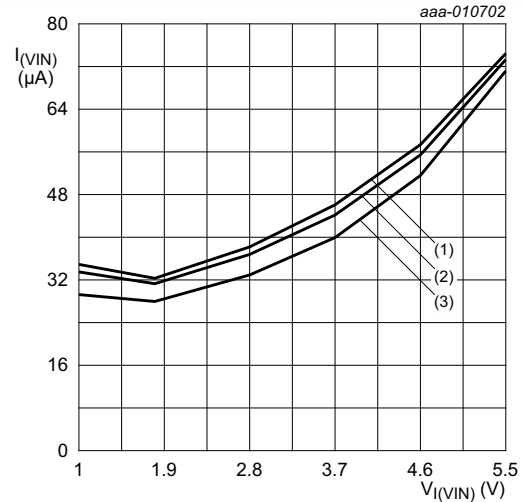

- $V_{I(EN)} = V_{I(VIN)}$
- (1) $T_{amb} = 85 \text{ }^\circ\text{C.}$
 - (2) $T_{amb} = 25 \text{ }^\circ\text{C.}$
 - (3) $T_{amb} = -40 \text{ }^\circ\text{C.}$

Fig 6. Typical supply current versus input voltage on pin VIN

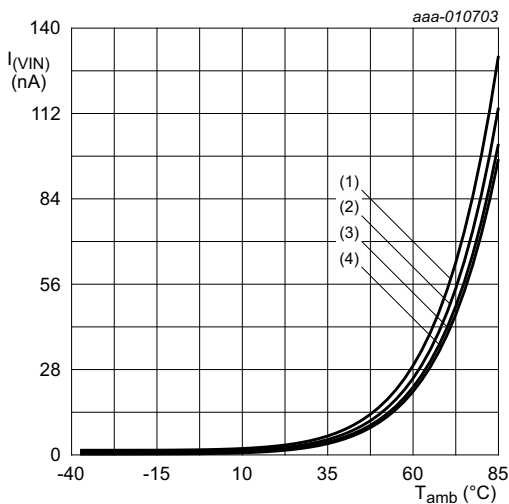

- $V_{I(EN)} = \text{GND.}$
- (1) $V_{I(VIN)} = 5.5 \text{ V.}$
 - (2) $V_{I(VIN)} = 3.6 \text{ V.}$
 - (3) $V_{I(VIN)} = 1.8 \text{ V.}$
 - (4) $V_{I(VIN)} = 1.0 \text{ V.}$

Fig 7. Typical supply current versus temperature

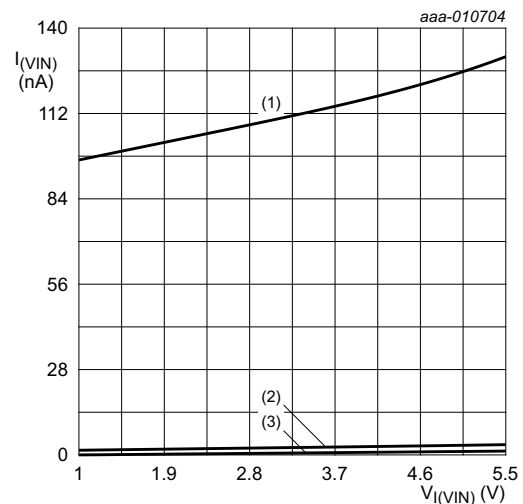

- $V_{I(EN)} = \text{GND.}$
- (1) $T_{amb} = 85 \text{ }^\circ\text{C.}$
 - (2) $T_{amb} = 25 \text{ }^\circ\text{C.}$
 - (3) $T_{amb} = -40 \text{ }^\circ\text{C.}$

Fig 8. Typical supply current versus input voltage on pin VIN

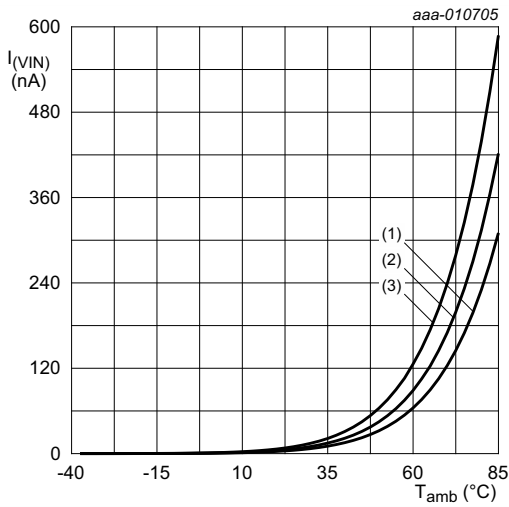

- (1) $V_{I(VIN)} = 1.8 \text{ V}$.
- (2) $V_{I(VIN)} = 3.6 \text{ V}$.
- (3) $V_{I(VIN)} = 5.5 \text{ V}$.

Fig 9. Typical OFF-state leakage current versus temperature

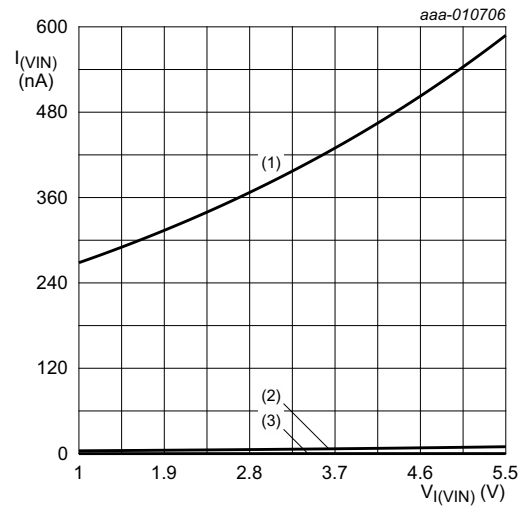

- (1) $T_{amb} = 85 \text{ °C}$.
- (2) $T_{amb} = 25 \text{ °C}$.
- (3) $T_{amb} = -40 \text{ °C}$.

Fig 10. Typical OFF-state leakage current versus input voltage on pin VIN

12.2 ON resistance

Table 9. ON resistance

At recommended operating conditions; voltages are referenced to GND (ground = 0 V)

Symbol	Parameter	Conditions	$T_{amb} = 25 \text{ °C}$			$T_{amb} = -40 \text{ °C to } +85 \text{ °C}$		Unit
			Min	Typ	Max	Min	Max	
R_{ON}	ON resistance	$V_{I(EN)} = 1.5 \text{ V}; I_{LOAD} = 200 \text{ mA};$ see Figure 11 , 12 and 13 $V_{I(VIN)} = 0.8 \text{ V to } 5.5 \text{ V}$	-	14	-	-	20	$m\Omega$

12.3 ON resistance test circuit and graphs

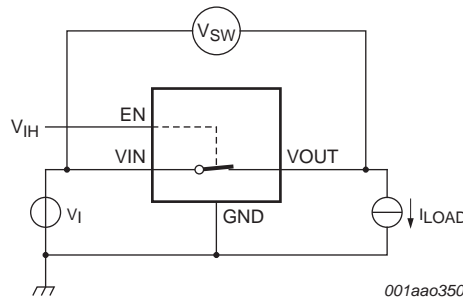

$$R_{ON} = V_{SW} / I_{LOAD}$$

Fig 11. Test circuit for measuring ON resistance

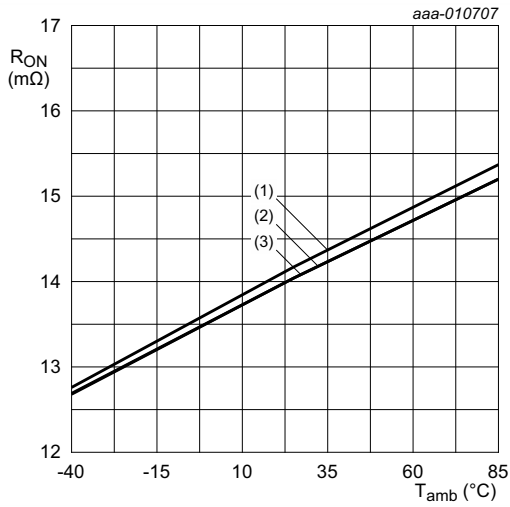

- (1) $V_{I(VIN)} = 1.0\text{ V}$.
- (2) $V_{I(VIN)} = 3.6\text{ V}$.
- (3) $V_{I(VIN)} = 5.5\text{ V}$.

Fig 12. ON resistance versus temperature

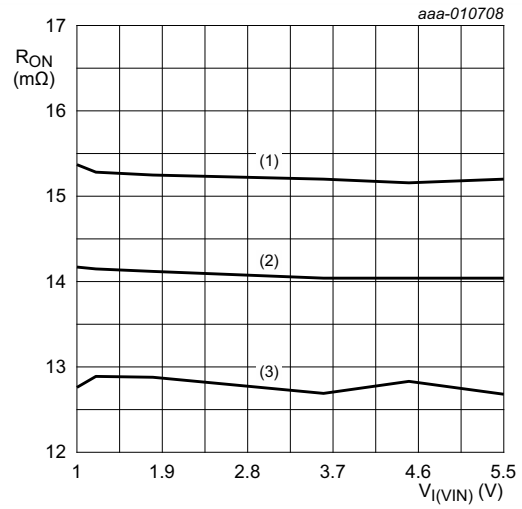

- (1) $T_{amb} = 85\text{ }^{\circ}C$.
- (2) $T_{amb} = 25\text{ }^{\circ}C$.
- (3) $T_{amb} = -40\text{ }^{\circ}C$.

Fig 13. ON resistance versus input voltage

13. Dynamic characteristics

Table 10. Dynamic characteristics

At recommended operating conditions; voltages are referenced to GND (ground = 0 V); for test circuit, see [Figure 15](#).

Symbol	Parameter	Conditions	T _{amb} = 25 °C			T _{amb} = -40 °C to +85 °C		Unit
			Min	Typ	Max	Min	Max	
t _{en}	enable time	EN to VOUT; see Figure 14 , 16 , 17 , 18 and 20						
		V _{I(VIN)} = 0.8 V	-	600	-	-	-	µs
		V _{I(VIN)} = 1.0 V	-	240	-	-	-	µs
		V _{I(VIN)} = 3.6 V	-	90	-	-	-	µs
t _{dis}	disable time	EN to VOUT; see Figure 14 , 19 and 21						
		V _{I(VIN)} = 0.8 V	-	210	-	-	-	µs
		V _{I(VIN)} = 1.0 V	-	20	-	-	-	µs
		V _{I(VIN)} = 3.6 V	-	5	-	-	-	µs
t _{on}	turn-on time	EN to VOUT; see Figure 14 , 16 , 17 , 18 and 20						
		V _{I(VIN)} = 0.8 V	-	1000	-	-	-	µs
		V _{I(VIN)} = 1.0 V	-	350	-	-	-	µs
		V _{I(VIN)} = 3.6 V	-	240	-	-	-	µs
t _{off}	turn-off time	EN to VOUT; see Figure 14 , 19 and 21						µs
		V _{I(VIN)} = 0.8 V	-	220.0	-	-	-	µs
		V _{I(VIN)} = 1.0 V	-	22.3	-	-	-	µs
		V _{I(VIN)} = 3.6 V	-	7.2	-	-	-	µs
t _{TLH}	LOW to HIGH output transition time	VOUT; see Figure 14						
		V _{I(VIN)} = 0.8 V	-	400	-	-	-	µs
		V _{I(VIN)} = 1.0 V	-	110	-	20	-	µs
		V _{I(VIN)} = 3.6 V	-	150	-	50	-	µs
t _{THL}	HIGH to LOW output transition time	VOUT; see Figure 14						
		V _{I(VIN)} = 0.8 V	-	10.0	-	-	-	µs
		V _{I(VIN)} = 1.0 V	-	2.3	-	-	-	µs
		V _{I(VIN)} = 3.6 V	-	2.2	-	-	-	µs
		V _{I(VIN)} = 5.5 V	-	2.0	-	-	-	µs

13.1 Waveforms, graphs and test circuit

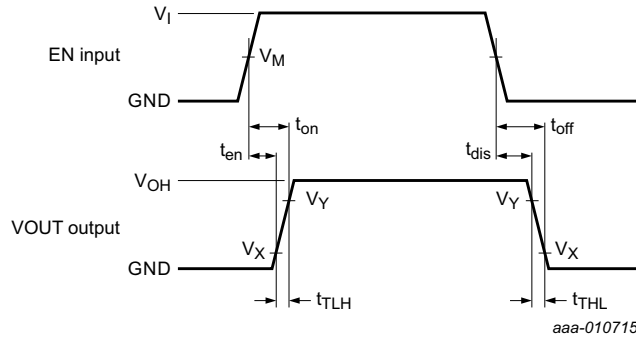

Measurement points are given in [Table 11](#).
 Logic level: V_{OH} is the typical output voltage that occurs with the output load.

Fig 14. Switching times

Table 11. Measurement points

Supply voltage	EN Input	Output	
$V_{I(VIN)}$	V_M	V_X	V_Y
1.0 V to 5.5 V	$0.5 \times V_{I(EN)}$	$0.1 \times V_{OH}$	$0.9 \times V_{OH}$

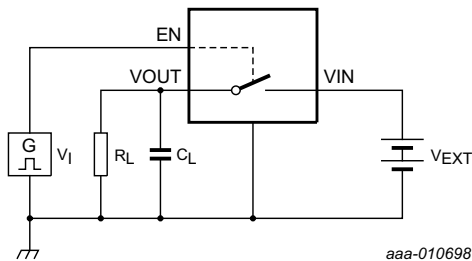

Test data is given in [Table 12](#).
 Definitions test circuit:
 R_L = Load resistance.
 C_L = Load capacitance including jig and probe capacitance.
 V_{EXT} = External voltage for measuring switching times.

Fig 15. Test circuit for measuring switching times

Table 12. Test data

Supply voltage	Input	Load	
V_{EXT}	$V_{I(EN)}$	C_L	R_L
1.0 V to 5.5 V	1.5 V	0.1 μ F	10 Ω

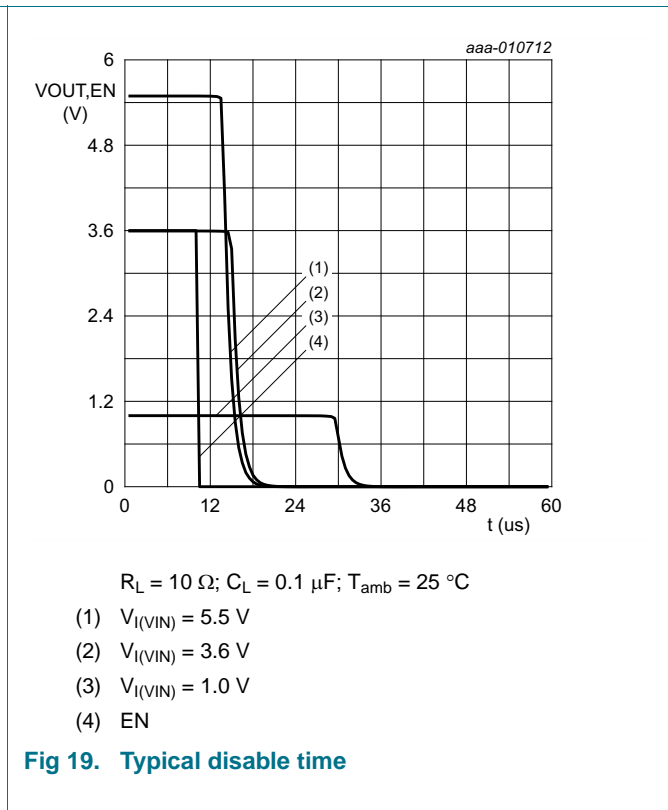
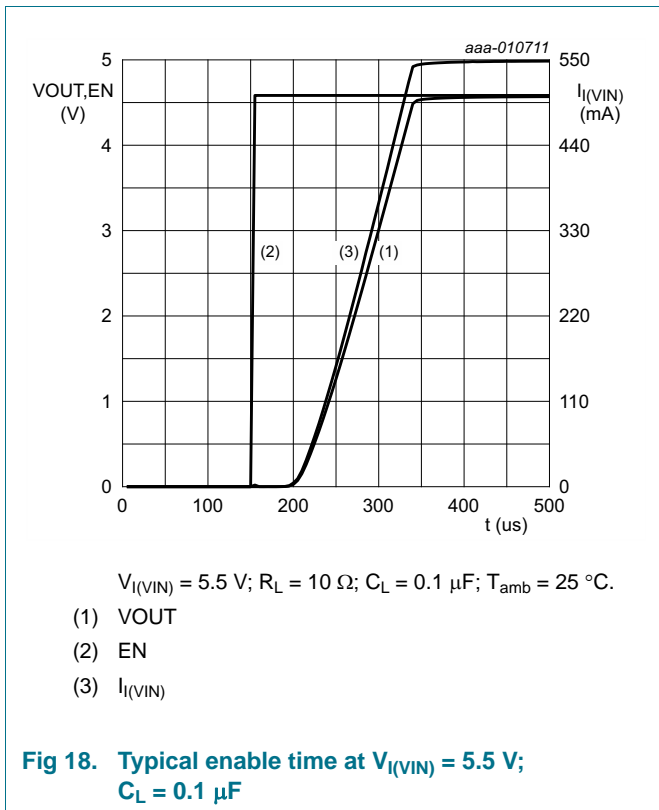
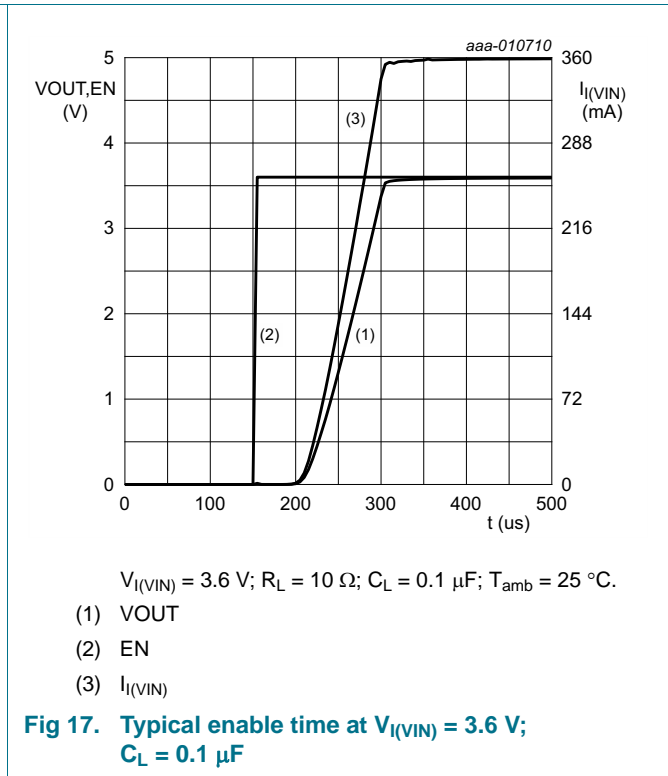
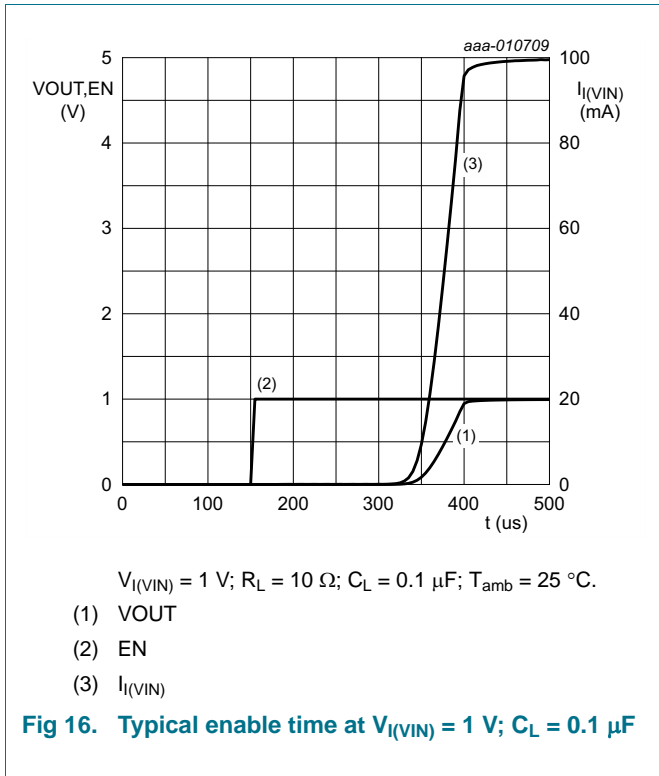

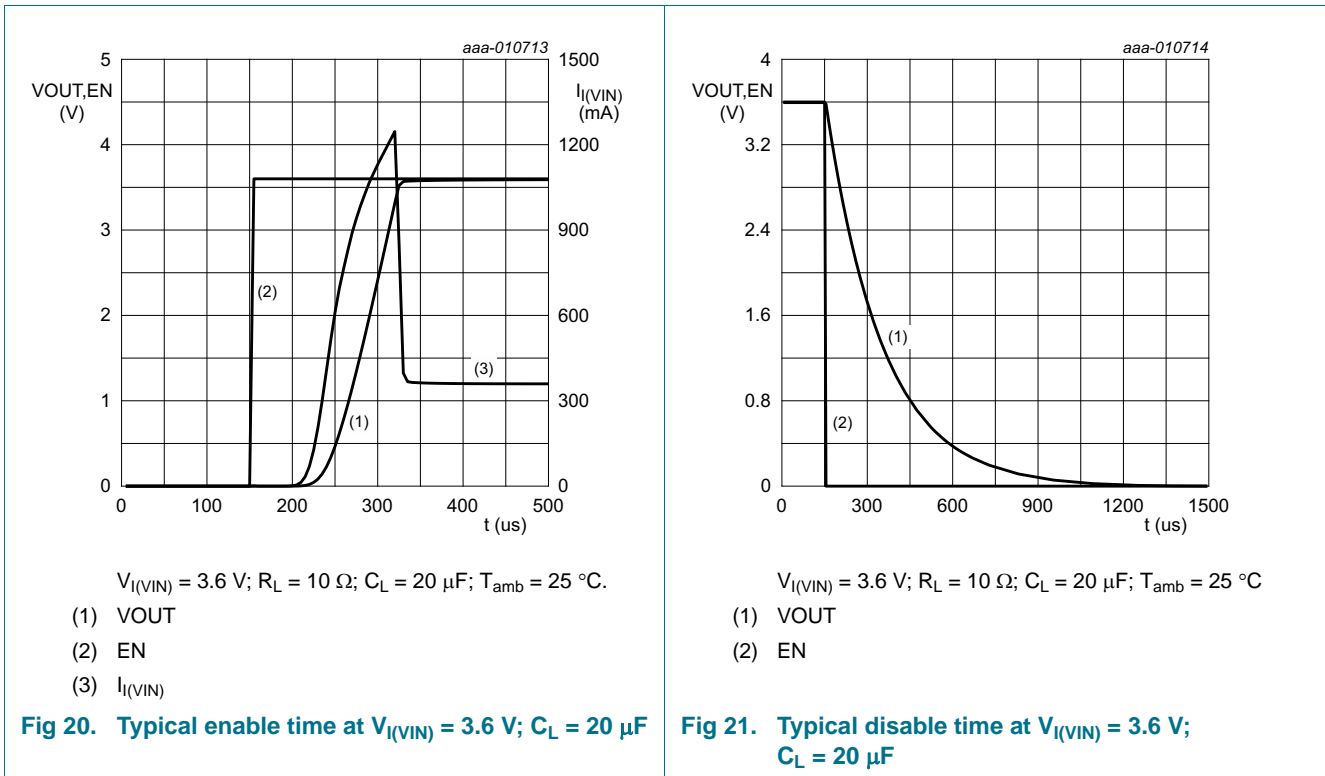

14. Package outline

WLCSP6: wafer level chip-scale package; 6 bumps; 0.87 x 1.37 x 0.50 mm

NX5P2924B

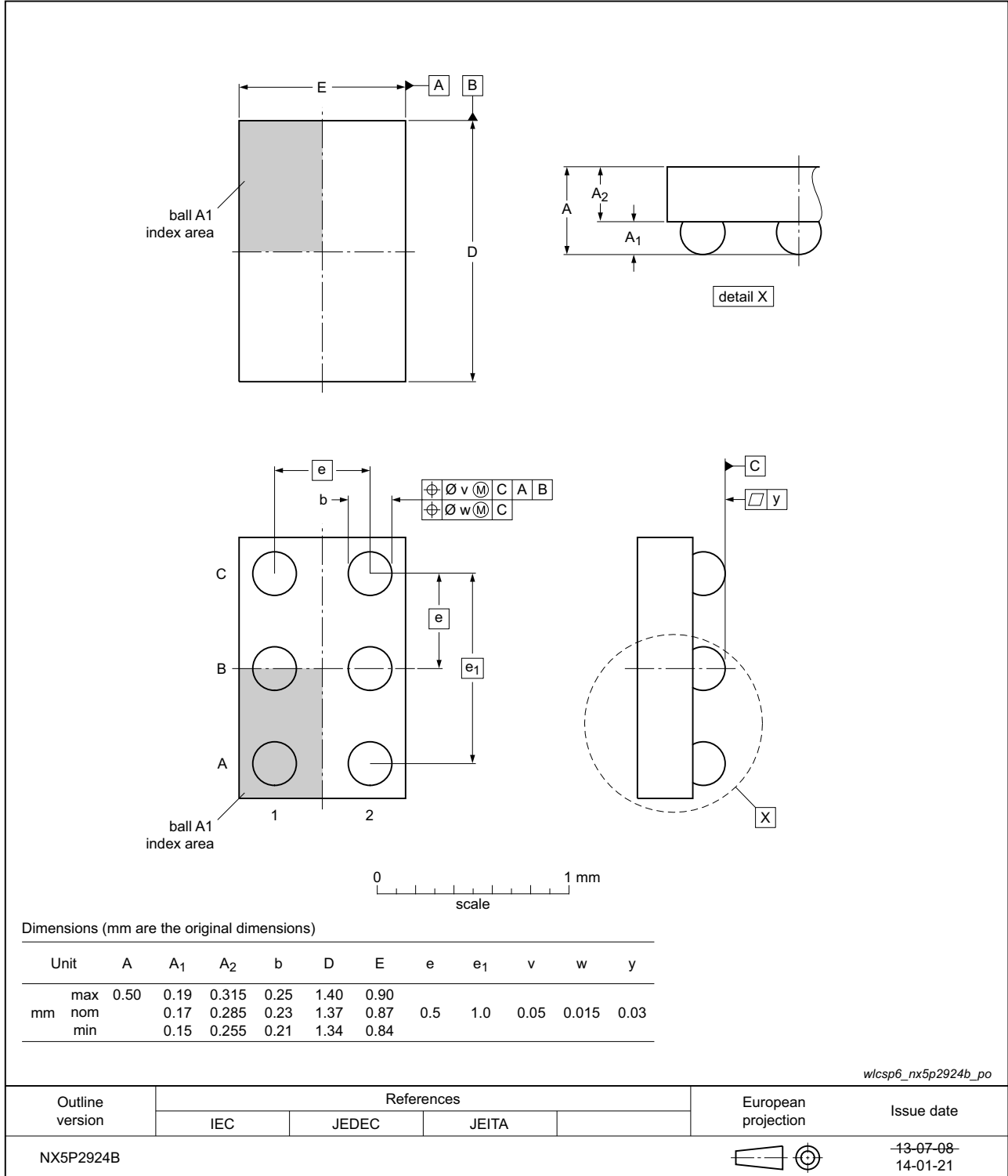

Fig 22. Package outline NX5P2924B

15. Abbreviations

Table 13. Abbreviations

Acronym	Description
CDM	Charged Device Model
DUT	Device Under Test
ESD	ElectroStatic Discharge
HBM	Human Body Model
IEC	International Electrotechnical Commission
MOSFET	Metal-Oxide Semiconductor Field Effect Transistor

16. Revision history

Table 14. Revision history

Document ID	Release date	Data sheet status	Change notice	Supersedes
NX5P2924B v.1	20140224	Product data sheet	-	-

17. Legal information

17.1 Data sheet status

Document status ^{[1][2]}	Product status ^[3]	Definition
Objective [short] data sheet	Development	This document contains data from the objective specification for product development.
Preliminary [short] data sheet	Qualification	This document contains data from the preliminary specification.
Product [short] data sheet	Production	This document contains the product specification.

[1] Please consult the most recently issued document before initiating or completing a design.

[2] The term 'short data sheet' is explained in section "Definitions".

[3] The product status of device(s) described in this document may have changed since this document was published and may differ in case of multiple devices. The latest product status information is available on the Internet at URL <http://www.nxp.com>.

17.2 Definitions

Draft — The document is a draft version only. The content is still under internal review and subject to formal approval, which may result in modifications or additions. NXP Semiconductors does not give any representations or warranties as to the accuracy or completeness of information included herein and shall have no liability for the consequences of use of such information.

Short data sheet — A short data sheet is an extract from a full data sheet with the same product type number(s) and title. A short data sheet is intended for quick reference only and should not be relied upon to contain detailed and full information. For detailed and full information see the relevant full data sheet, which is available on request via the local NXP Semiconductors sales office. In case of any inconsistency or conflict with the short data sheet, the full data sheet shall prevail.

Product specification — The information and data provided in a Product data sheet shall define the specification of the product as agreed between NXP Semiconductors and its customer, unless NXP Semiconductors and customer have explicitly agreed otherwise in writing. In no event however, shall an agreement be valid in which the NXP Semiconductors product is deemed to offer functions and qualities beyond those described in the Product data sheet.

17.3 Disclaimers

Limited warranty and liability — Information in this document is believed to be accurate and reliable. However, NXP Semiconductors does not give any representations or warranties, expressed or implied, as to the accuracy or completeness of such information and shall have no liability for the consequences of use of such information. NXP Semiconductors takes no responsibility for the content in this document if provided by an information source outside of NXP Semiconductors.

In no event shall NXP Semiconductors be liable for any indirect, incidental, punitive, special or consequential damages (including - without limitation - lost profits, lost savings, business interruption, costs related to the removal or replacement of any products or rework charges) whether or not such damages are based on tort (including negligence), warranty, breach of contract or any other legal theory.

Notwithstanding any damages that customer might incur for any reason whatsoever, NXP Semiconductors' aggregate and cumulative liability towards customer for the products described herein shall be limited in accordance with the *Terms and conditions of commercial sale* of NXP Semiconductors.

Right to make changes — NXP Semiconductors reserves the right to make changes to information published in this document, including without limitation specifications and product descriptions, at any time and without notice. This document supersedes and replaces all information supplied prior to the publication hereof.

Suitability for use — NXP Semiconductors products are not designed, authorized or warranted to be suitable for use in life support, life-critical or safety-critical systems or equipment, nor in applications where failure or malfunction of an NXP Semiconductors product can reasonably be expected to result in personal injury, death or severe property or environmental damage. NXP Semiconductors and its suppliers accept no liability for inclusion and/or use of NXP Semiconductors products in such equipment or applications and therefore such inclusion and/or use is at the customer's own risk.

Applications — Applications that are described herein for any of these products are for illustrative purposes only. NXP Semiconductors makes no representation or warranty that such applications will be suitable for the specified use without further testing or modification.

Customers are responsible for the design and operation of their applications and products using NXP Semiconductors products, and NXP Semiconductors accepts no liability for any assistance with applications or customer product design. It is customer's sole responsibility to determine whether the NXP Semiconductors product is suitable and fit for the customer's applications and products planned, as well as for the planned application and use of customer's third party customer(s). Customers should provide appropriate design and operating safeguards to minimize the risks associated with their applications and products.

NXP Semiconductors does not accept any liability related to any default, damage, costs or problem which is based on any weakness or default in the customer's applications or products, or the application or use by customer's third party customer(s). Customer is responsible for doing all necessary testing for the customer's applications and products using NXP Semiconductors products in order to avoid a default of the applications and the products or of the application or use by customer's third party customer(s). NXP does not accept any liability in this respect.

Limiting values — Stress above one or more limiting values (as defined in the Absolute Maximum Ratings System of IEC 60134) will cause permanent damage to the device. Limiting values are stress ratings only and (proper) operation of the device at these or any other conditions above those given in the Recommended operating conditions section (if present) or the Characteristics sections of this document is not warranted. Constant or repeated exposure to limiting values will permanently and irreversibly affect the quality and reliability of the device.

Terms and conditions of commercial sale — NXP Semiconductors products are sold subject to the general terms and conditions of commercial sale, as published at <http://www.nxp.com/profile/terms>, unless otherwise agreed in a valid written individual agreement. In case an individual agreement is concluded only the terms and conditions of the respective agreement shall apply. NXP Semiconductors hereby expressly objects to applying the customer's general terms and conditions with regard to the purchase of NXP Semiconductors products by customer.

No offer to sell or license — Nothing in this document may be interpreted or construed as an offer to sell products that is open for acceptance or the grant, conveyance or implication of any license under any copyrights, patents or other industrial or intellectual property rights.

Export control — This document as well as the item(s) described herein may be subject to export control regulations. Export might require a prior authorization from competent authorities.

Non-automotive qualified products — Unless this data sheet expressly states that this specific NXP Semiconductors product is automotive qualified, the product is not suitable for automotive use. It is neither qualified nor tested in accordance with automotive testing or application requirements. NXP Semiconductors accepts no liability for inclusion and/or use of non-automotive qualified products in automotive equipment or applications.

In the event that customer uses the product for design-in and use in automotive applications to automotive specifications and standards, customer (a) shall use the product without NXP Semiconductors' warranty of the product for such automotive applications, use and specifications, and (b) whenever customer uses the product for automotive applications beyond

NXP Semiconductors' specifications such use shall be solely at customer's own risk, and (c) customer fully indemnifies NXP Semiconductors for any liability, damages or failed product claims resulting from customer design and use of the product for automotive applications beyond NXP Semiconductors' standard warranty and NXP Semiconductors' product specifications.

Translations — A non-English (translated) version of a document is for reference only. The English version shall prevail in case of any discrepancy between the translated and English versions.

17.4 Trademarks

Notice: All referenced brands, product names, service names and trademarks are the property of their respective owners.

18. Contact information

For more information, please visit: <http://www.nxp.com>

For sales office addresses, please send an email to: salesaddresses@nxp.com

19. Contents

1	General description	1
2	Features and benefits	1
3	Applications	1
4	Ordering information	2
5	Marking	2
6	Functional diagram	2
7	Pinning information	3
7.1	Pinning	3
7.2	Pin description	3
8	Functional description	3
9	Limiting values	4
10	Recommended operating conditions	4
11	Thermal characteristics	5
12	Static characteristics	5
12.1	Graphs	7
12.2	ON resistance	8
12.3	ON resistance test circuit and graphs	8
13	Dynamic characteristics	10
13.1	Waveforms, graphs and test circuit	11
14	Package outline	14
15	Abbreviations	15
16	Revision history	15
17	Legal information	16
17.1	Data sheet status	16
17.2	Definitions	16
17.3	Disclaimers	16
17.4	Trademarks	17
18	Contact information	17
19	Contents	18

Please be aware that important notices concerning this document and the product(s) described herein, have been included in section 'Legal information'.

© NXP B.V. 2014.

All rights reserved.

For more information, please visit: <http://www.nxp.com>

For sales office addresses, please send an email to: salesaddresses@nxp.com

Date of release: 24 February 2014

Document identifier: NX5P2924B