

AFE5807/08EVM (Rev D) Evaluation Module

This document assists users in evaluating the AFE5807 and AFE5808 highly integrated analog front-end devices through the use of the AFE5807/08EVM Evaluation Module. Included are setup instructions, printed-circuit board art, bill of materials, and schematics.

Contents

1	Overview	2
2	Default Configuration	2
3	Software Installation and Operation	3
	3.1 GUI Installation (Mandatory)	3
	3.2 USB Interface Driver Installation	3
4	Test Setup	5
5	Power Up AFE5807/08	6
6	Launch AFE5807/08 GUI	6
7	Launch TSW1250 GUI	7
8	TEST AFE5807/08	8
	8.1 Step 1: Time Domain	8
	8.2 Step 2: Single Tone FFT	10
9	Hardware Setup, CW Mode	12
	9.1 Step 1: Switch to CW Mode.	12
	9.2 Step 2: Apply input and observe outputs.	13
	9.3 External Clock for CW Mode	14
10	External ADC Sampling Clock	16
11	External Vcntl	18
12	Board Configuration	20
	12.1 Input/Output, Power Supply, and USB	20
	12.2 CW Mode, ADC Clock	21
	12.3 Vcntl Control Input	22
	12.4 LEDs	23
	12.5 Miscellaneous Test Points	24
13	EVM Printed-Circuit Board Layouts and Schematics	25
14	Bill of Materials	31

List of Figures

1	AFE5807/08EVM Basic Configuration	3
2	HW Setup With Connection Between TSW1250EVM and AFE5807/08	5
3	User Interface: Single FFT Format	11
4	Setup for CW Mode	12
5	Switching From Default (ADC) Mode Panel to CW Mode Panel	13
6	CW Outputs	14
7	Relevant Capacitors for CW Mode, Top Side	15
8	Relevant Capacitors for CW Mode, Bottom Side	16
9	External ADC Sampling Clock Configuration	17
10	External Vcntl Configuration	19
11	I/O, PWR, and USB Connector	20

Windows is a trademark of Microsoft Corporation.

12	AFE5807/08EVM Jumper Locations	21
13	Vcntl	22
14	AFE5807/08EVM LED Location	23
15	AFE5807/08EVM Test Point Locations	24
16	Top Layer - Signal	25
17	Second Layer - Ground	26
18	Third Layer - Power	27
19	Fourth Layer - Signal	28
20	Fifth Layer - Ground	29
21	Bottom Layer - Signal	30

List of Tables

1	Configuration for Clock Capacitors	14
2	Input/Output, Power, and USB	20
3	CW Mode, ADC Clock	21
4	CW Mode and Vcntl	22
5	LED Indicators	23
6	Test Points	24
7	Bill of Materials	31

1 Overview

This document is intended to guide users step-by-step through the AFE5807/08EVM Evaluation Module (EVM) setup and test. The EVM is shipped with a default configuration from the manufacturer. With this configuration, the onboard CMOS clock is used for an analog-to-digital converter sampling clock; the onboard oscillator is used for CW mode operation. No external clock generator is required. Users need to provide the input signal for measurement from a signal generator.

Detail explanation regarding the jumpers, connectors, and test points appear in [Section 12](#). The graphical user interface (GUI) can be downloaded from the TI Web site.

2 Default Configuration

[Figure 1](#) shows the default configuration of the EVM from the factory. The accompanying list identifies the basic components on the EVM board.

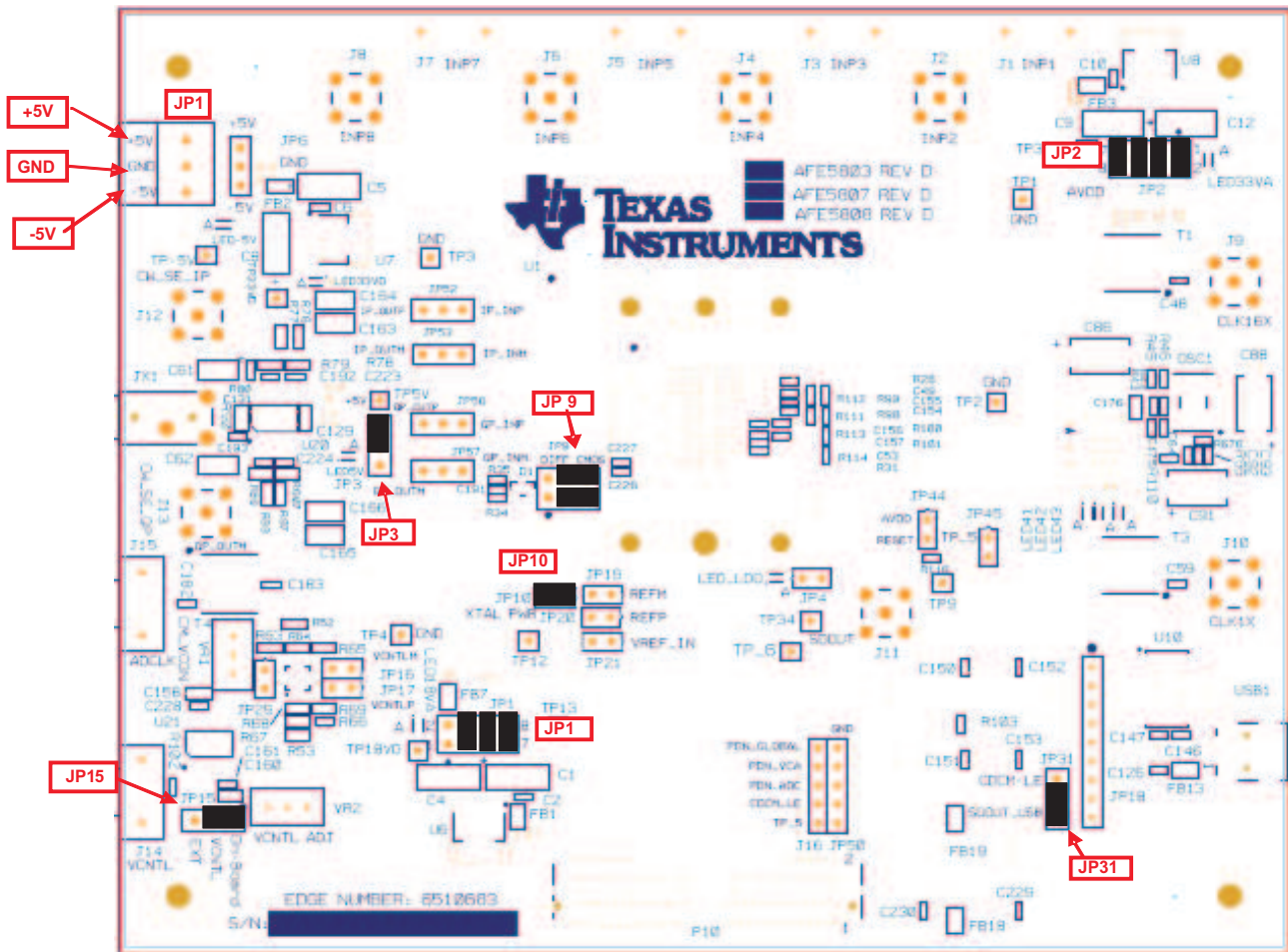

Figure 1. AFE5807/08EVM Basic Configuration

1. P1 – Power supplies connector.
2. JP1, JP2, and JP3 are set to enable 3.3-V, 1.8-V, and 5-V power supplies to device.
3. JP9: enables onboard CMOS clock.
4. JP10: Power supply for onboard CMOS clock oscillator.
5. JP15: Enables onboard VCNT.
6. JP31 always set as Figure 1.

3 Software Installation and Operation

The AFE5807/08EVM comes with a software installation compact disk (CD); run setup.exe to install the software.

3.1 GUI Installation (Mandatory)

Unzip the installer file in the CD. Run **setup.exe** to install the GUI.

3.2 USB Interface Driver Installation

- Connect the USB port of the EVM to your personal computer (PC).
- If the driver has not been installed, then the message "Window Found New Hardware" appears. As shown in the following illustration, the Wizard launches. Otherwise, skip this section, and go to [Section 4](#).

- Select "No, not this time" from the options. Press the Next button.



- Select "Install from a list or specific location (Advanced)" as shown in the following illustration, and then click "Next."

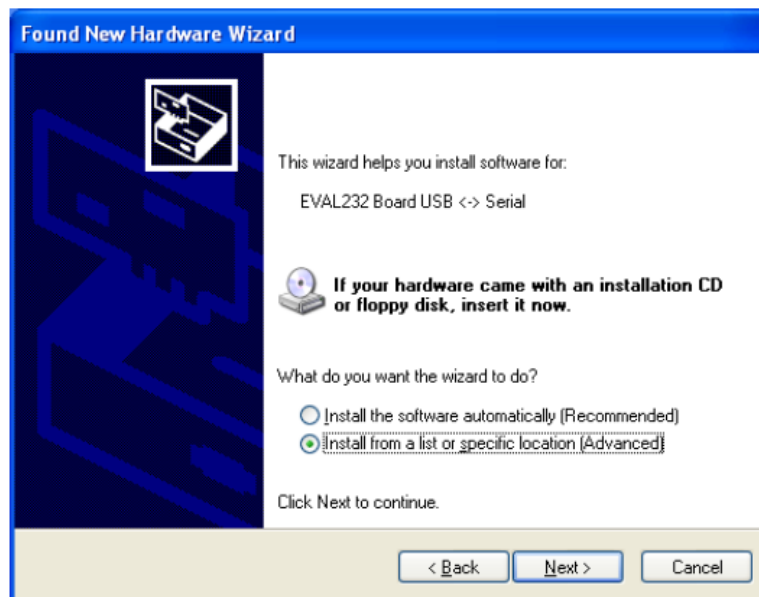

- Select "Search for the best driver in these locations," and enter the file path C:\Program Files\Texas Instruments\CDM 2.04.06 WHQL Certified in the combo-box, or browse to it by clicking the browse button. Once the file path has been entered in the box, click Next to proceed.
- If Windows™ XP is configured to warn when unsigned (non-WHQL certified) drivers are about to be installed, the following screen is displayed unless installing a Microsoft WHQL certified driver. Click on "Continue Anyway" to continue with the installation. If Windows XP is configured to ignore file signature warnings, no message appears.



4 Test Setup

Two EVMs are required to evaluate the AFE5807/08 device. The following illustration shows the exact setup of these two boards and external connectors. For the default configuration as shown in Figure 1, it is unnecessary to have an external sampling clock and external Vcntl supply. The onboard CMOS clock and onboard Vcntl are used.

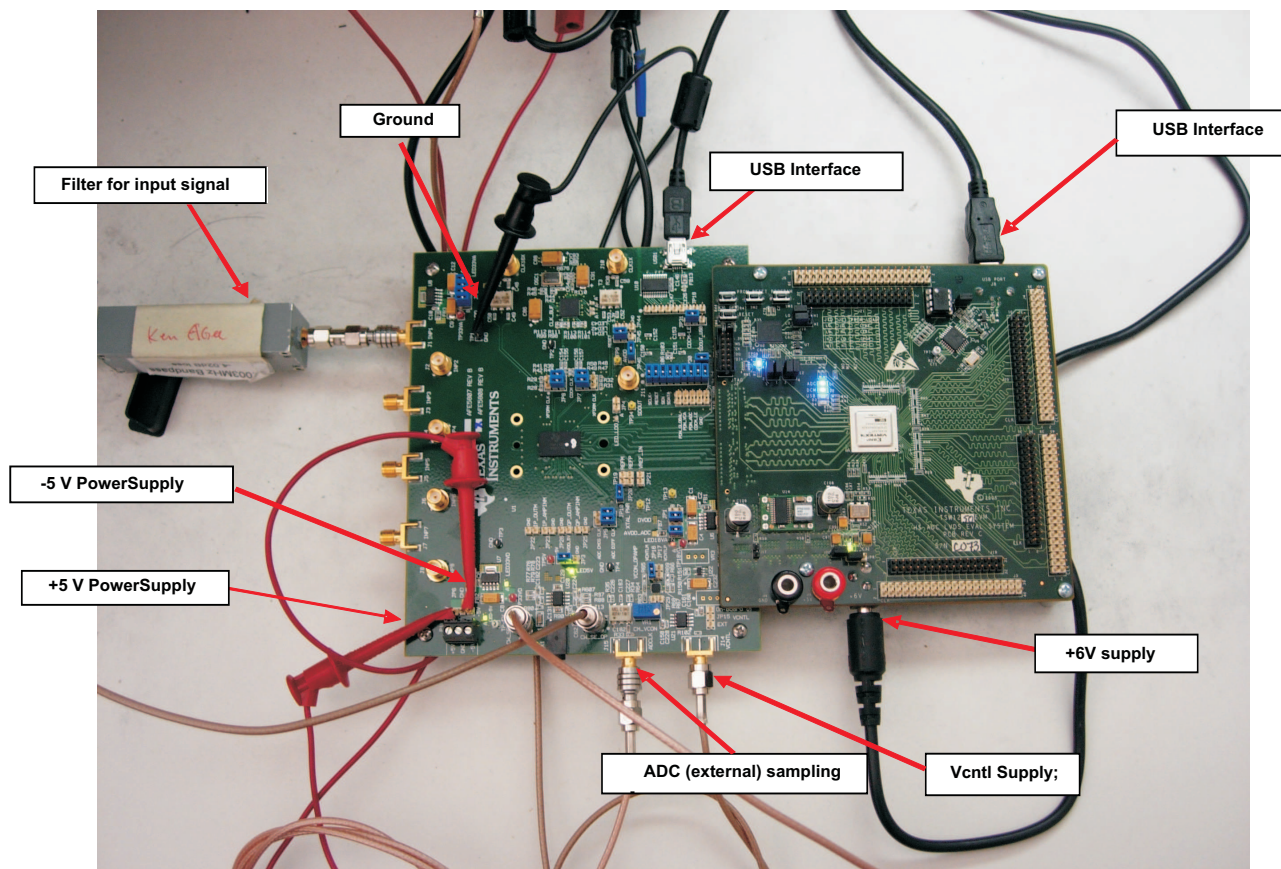
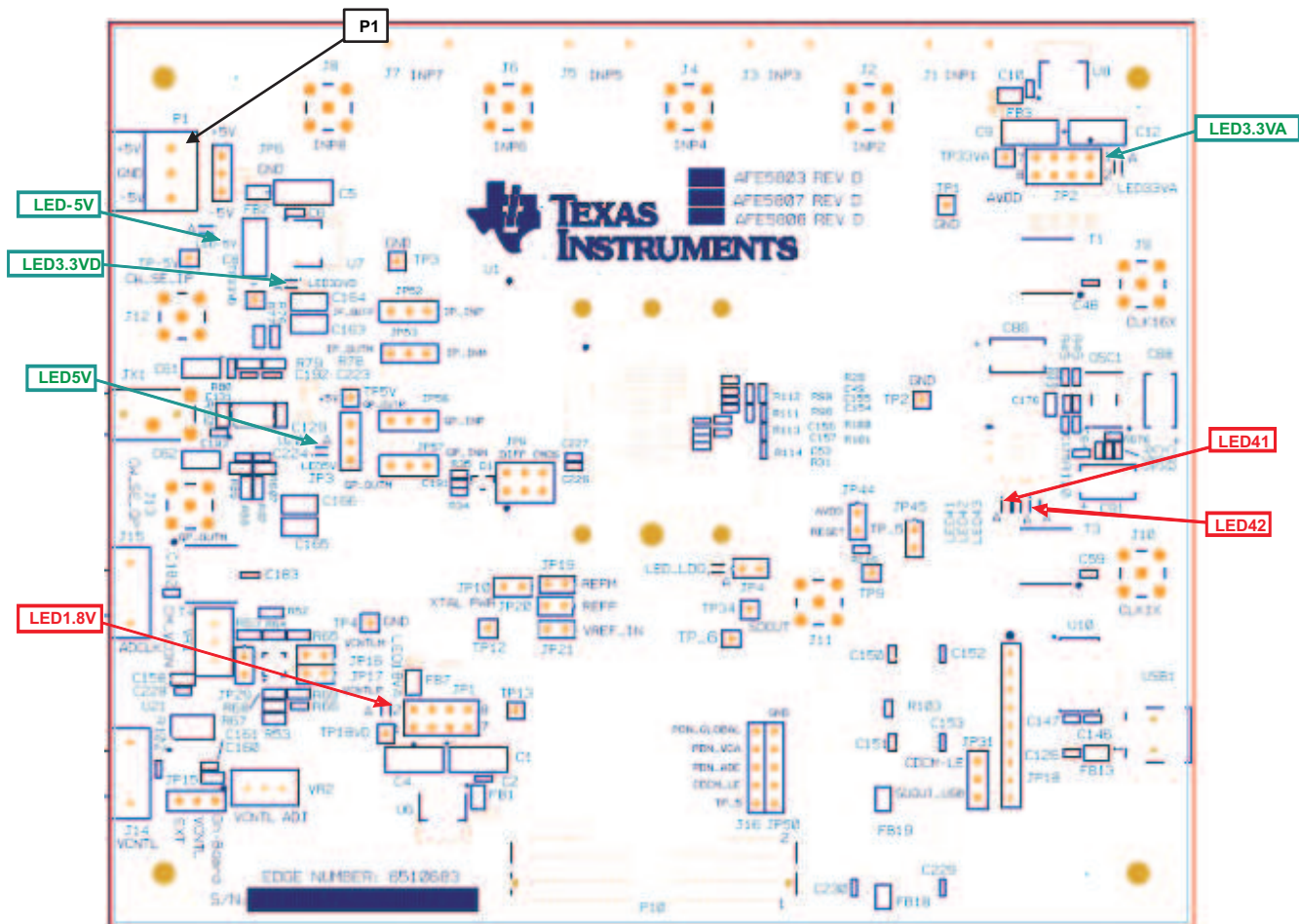

Figure 2. HW Setup With Connection Between TSW1250EVM and AFE5807/08

5 Power Up AFE5807/08

Power up the AFE5807/08EVM by applying +5 V and –5 V to the P1 connector. After power up is complete, four green LEDs and two red LEDs are turned on as shown in the following illustration.



6 Launch AFE5807/08 GUI

Launch the AFE5807/08 graphic user interface (GUI), which appears in the following illustration. After the GUI has completely launched, LED41 and LED42 go off and the rest of the LEDs remain on. The GUI automatically configures the default setup. Select the ADC page to observe the default condition.

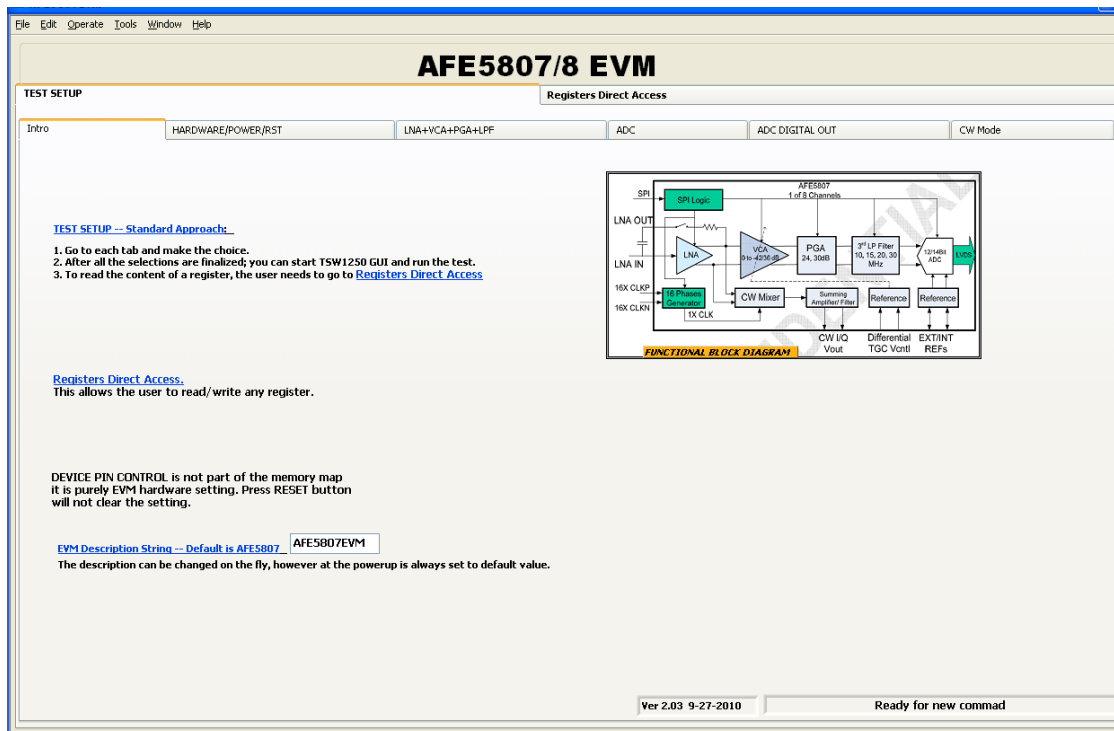

The following illustration shows the Default Condition on the ADC page.

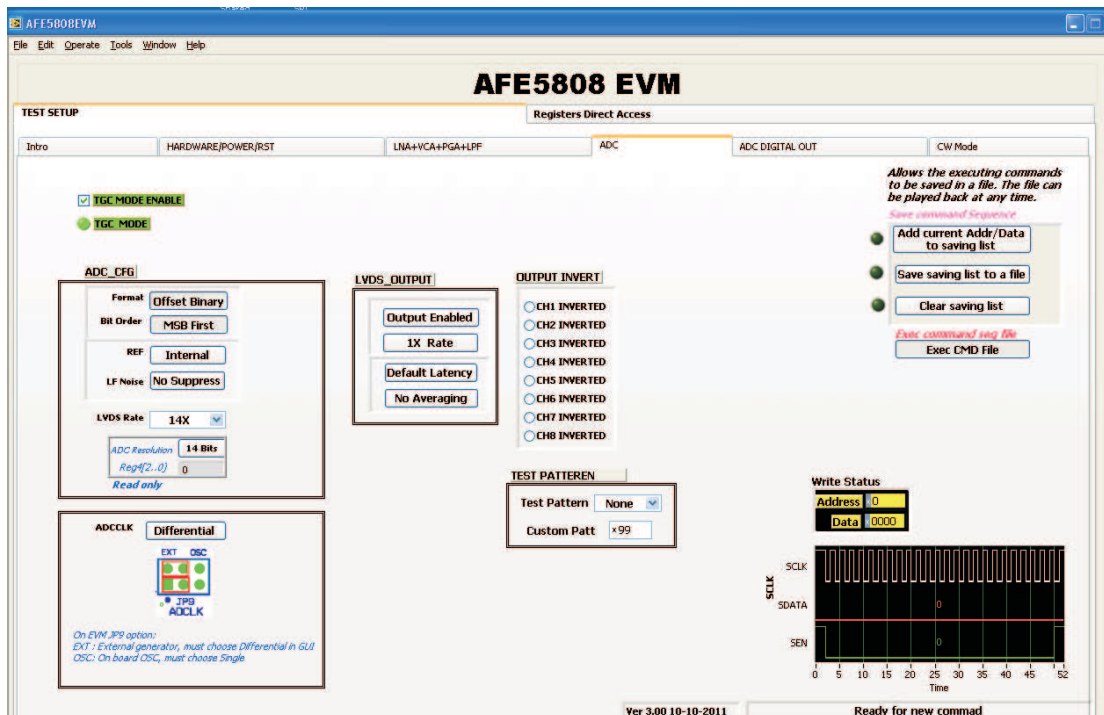

7 Launch TSW1250 GUI

Launch the TSW1250 GUI. The Message window displays the following message to indicate that the setup of the TSW1250EVM and AFE5807/08EVM is working properly. If a different message or an error message appears, contact TI FAE.

Select **AFE5807, 14 bits, MSB first** from the GUI.

ADC Sampling Rate is fixed at 40 MHz; this is the onboard CMOS clock frequency.

ADC Input Frequency – enter 2M, and the GUI calculates the real coherent frequency to 2.00439453M.

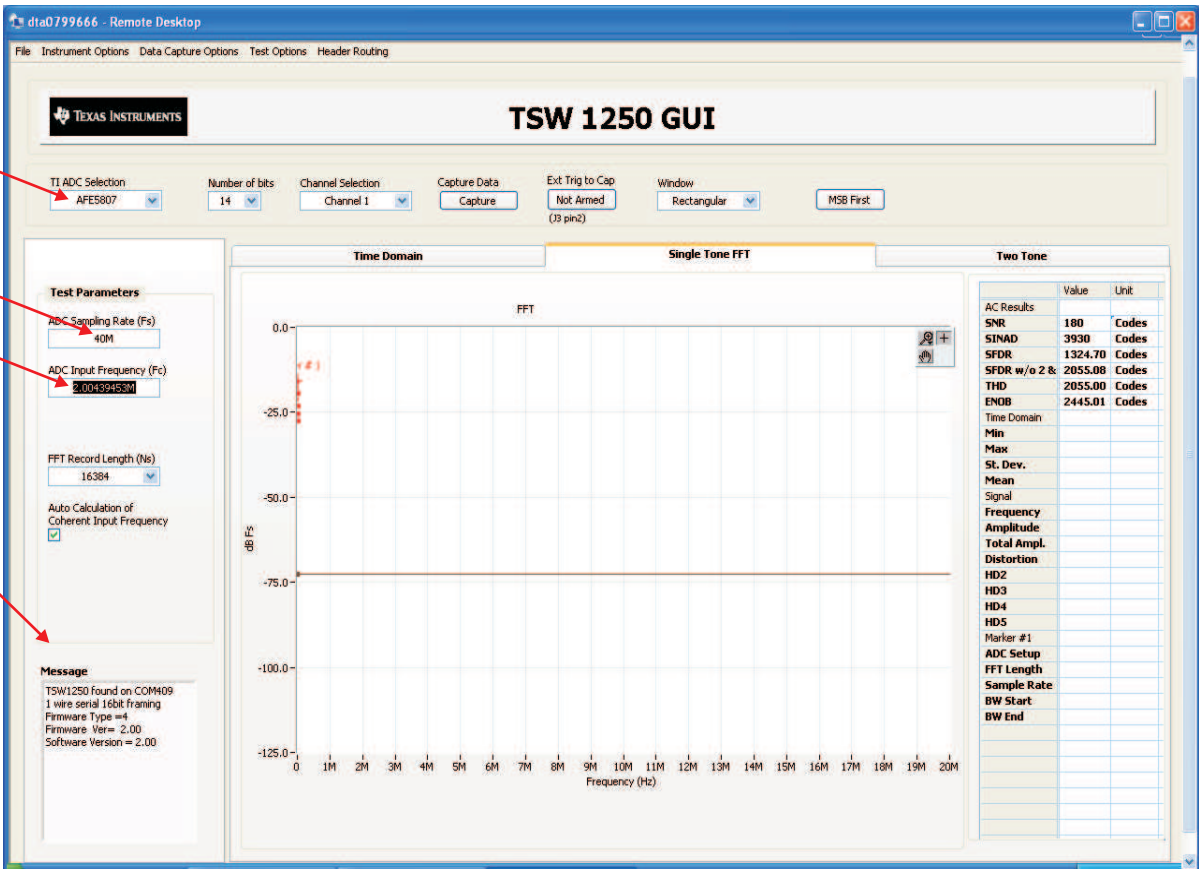

The screenshot shows the TSW 1250 GUI with the following settings and results:

- TI ADC Selection:** AFE5807
- Number of bits:** 14
- Channel Selection:** Channel 1
- Capture Data:** Capture
- Ext Trig to Cap:** Not Armed (39 pin2)
- Window:** Rectangular
- MSB First:** MSB First
- ADC Sampling Rate (Fs):** 40M
- ADC Input Frequency (Fc):** 2.00439453M
- FFT Record Length (Ns):** 16384
- Auto Calculation of Coherent Input Frequency:**
- Message:** TSW1250 found on COM409
1 wire serial 16bit framing
Firmware Type = 4
Firmware Ver = 2.00
Software Version = 2.00

The FFT plot shows a peak at approximately 2.00439453 MHz. The AC Results table is as follows:

AC Results	Value	Unit
SNR	180	Codes
SINAD	3930	Codes
SFDR	1324.70	Codes
SFDR w/o 2 &	2055.08	Codes
THD	2055.08	Codes
ENOB	2445.01	Codes

8 TEST AFE5807/08

8.1 Step 1: Time Domain

- Select the Time Domain page from the TSW1250 GUI.
- Uncheck **Overlay unwrap waveform**.

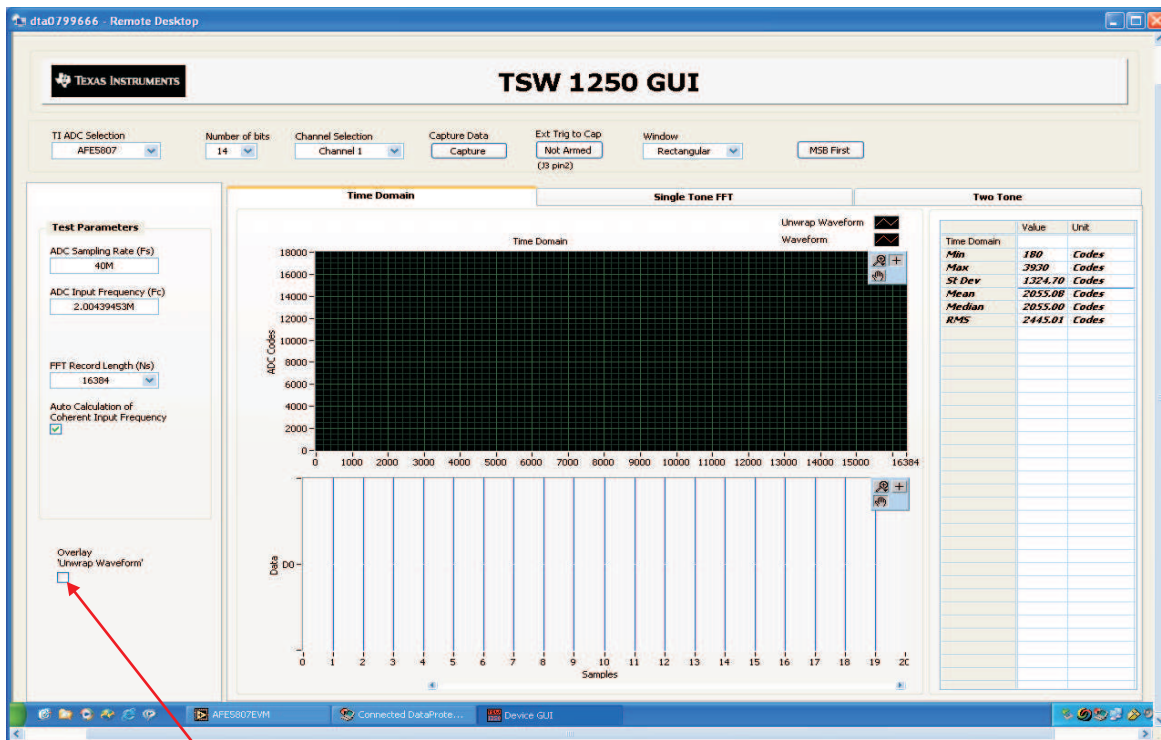

Overlay unwrap waveform

- From the AFE5808 GUI, go to the **ADC** page, and then select **Ramp**.

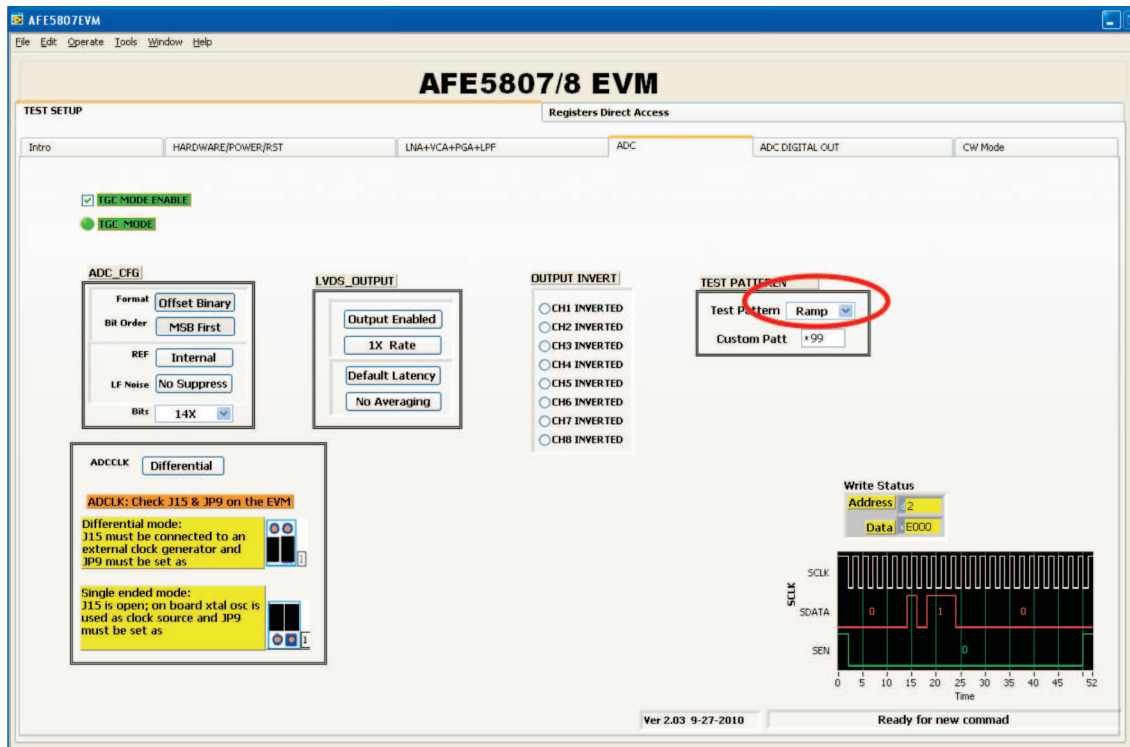

- Press the Capture button on the TSW1250 GUI. You will observe a ramping waveform on the TSW1250 GUI display area as shown in the following illustration.
- Repeat for Channel 2 and Channel 8.

- If each channel has the output as shown in the following illustration, proceed with the next step; otherwise, contact the TI FAE to troubleshoot the problem.
- On the AFE5808 GUI, change Test Pattern from **Ramp** to **None** for the next step.

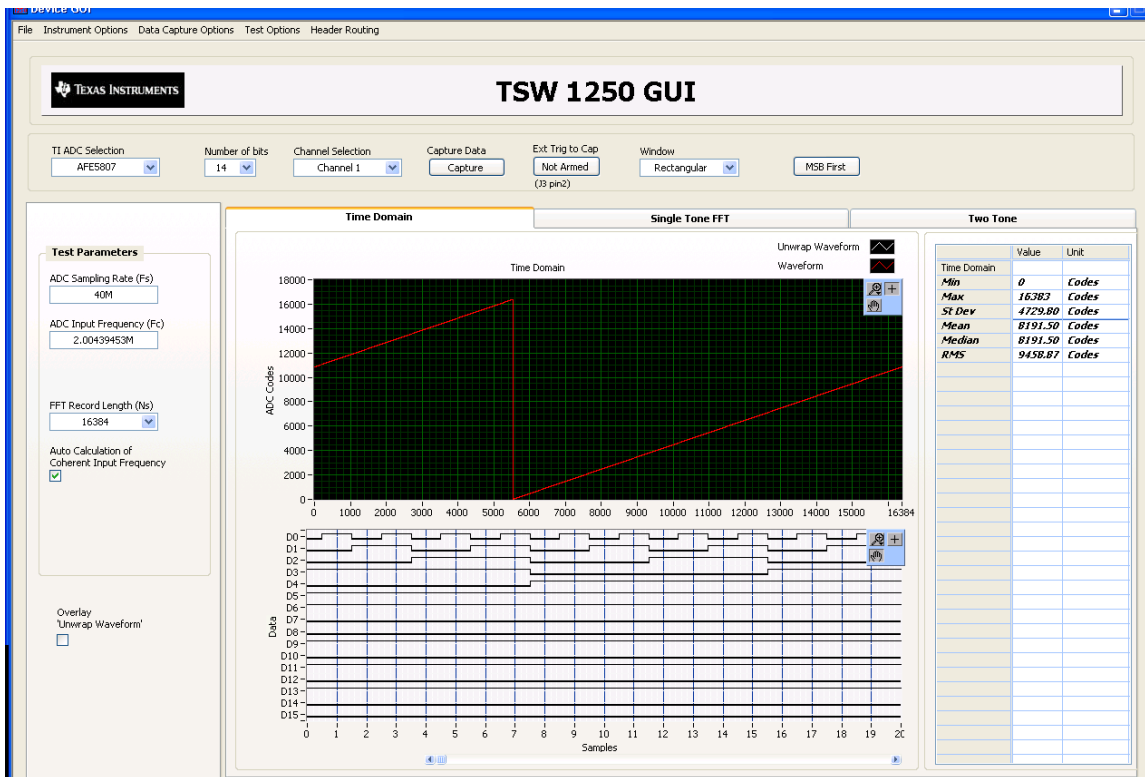

8.2 Step 2: Single Tone FFT

- Select the **Single Tone FFT** page at the TSW1250 GUI.
- Connect Channel 1 of the AFE5807EVM to a signal generator through an **LP filter**. If an LP filter is not present, the result will not be good.
- Set the amplitude of the signal generator to **-25dBm**.
- Set the frequency of the signal generator to **2.00439453M** to match the GUI.
- Change the window option to **Hanning**. This is because the input signal and the onboard CMOS clock are noncoherent.
- Press the Capture button to get the test result.
- Repeat for Channel 2 through Channel 8.

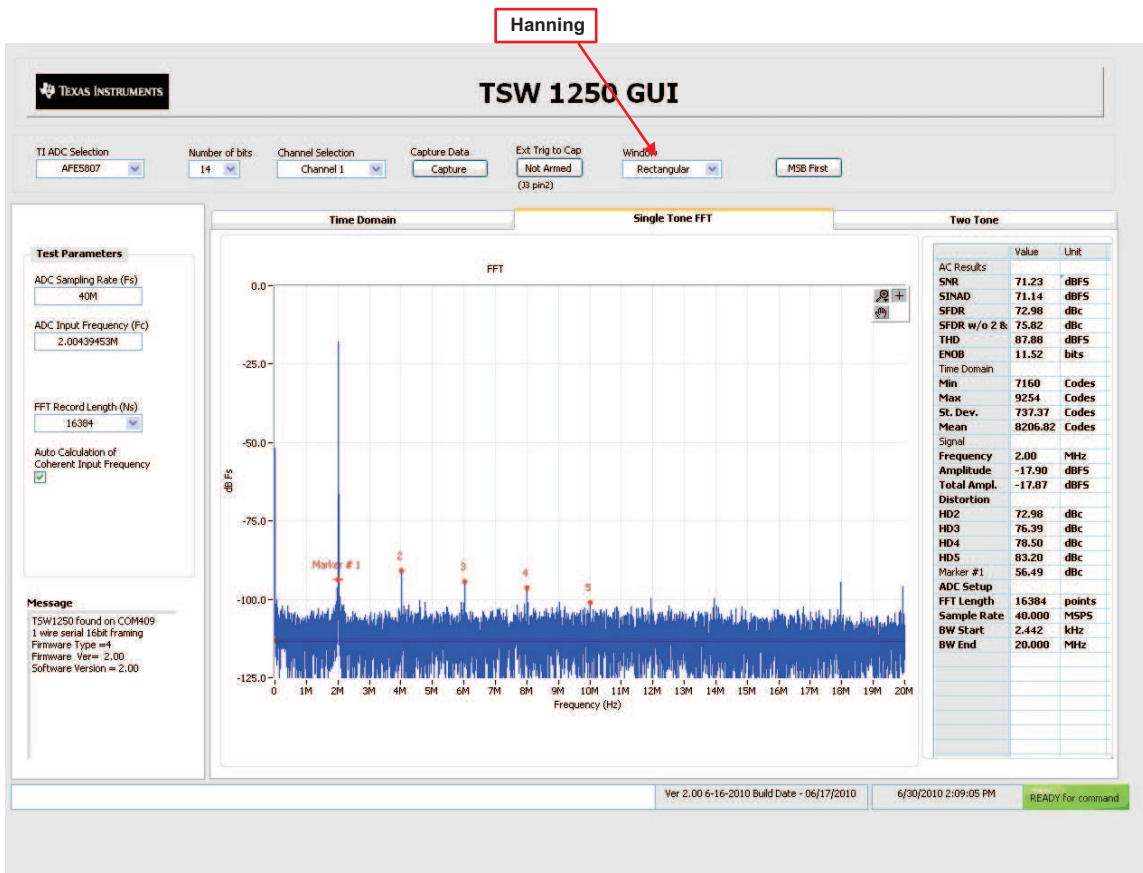

Figure 3. User Interface: Single FFT Format

9 Hardware Setup, CW Mode

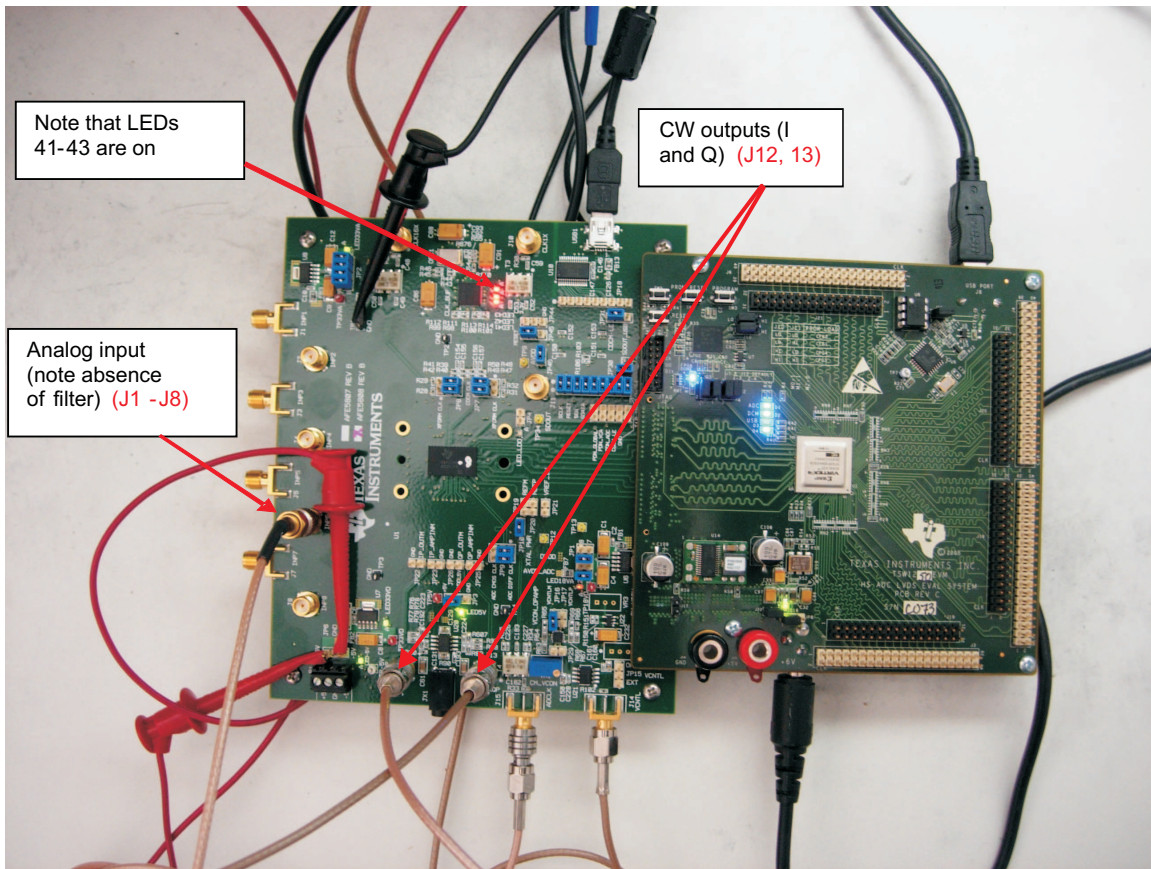

Figure 4. Setup for CW Mode

9.1 Step 1: Switch to CW Mode.

- Go to the **CW Mode** page.
- Check **CW Mode Enable**. The LED41, LED42, and LED43 on AFE5807/08EVM all illuminate.
- Select **500ohms** for the gain control feedback resistor.

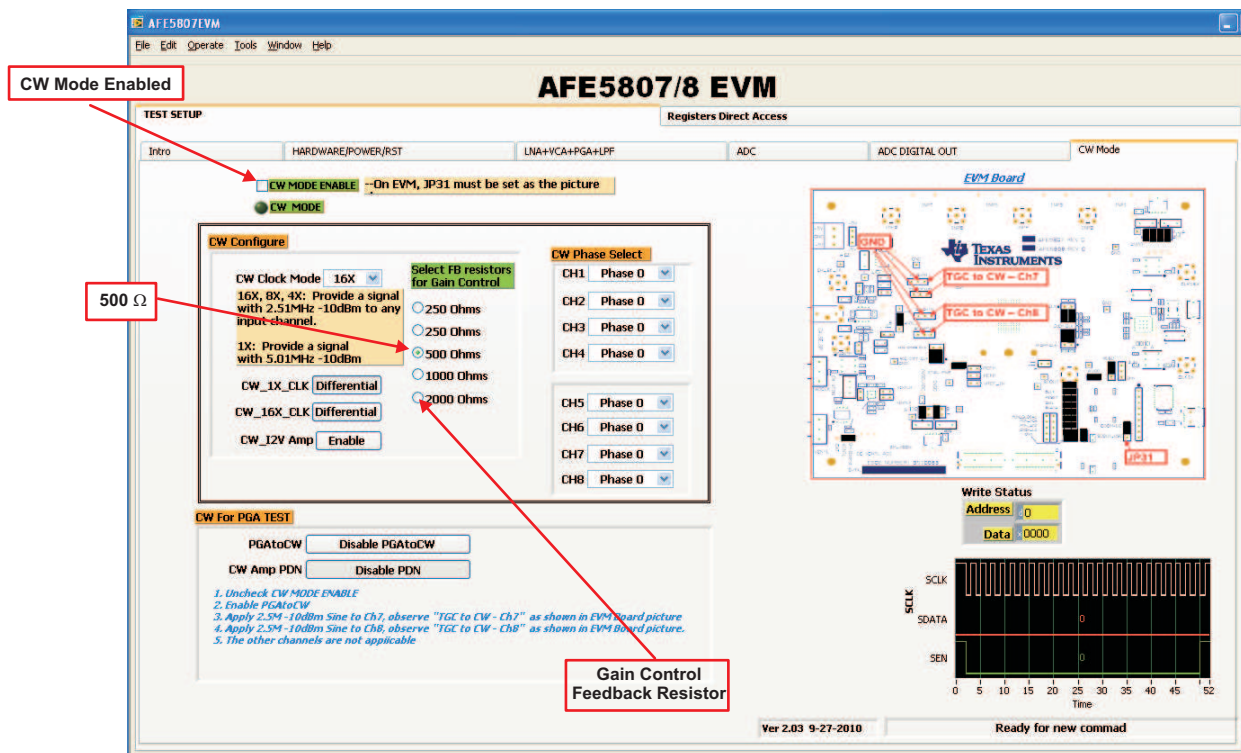

Figure 5. Switching From Default (ADC) Mode Panel to CW Mode Panel

9.2 Step 2: Apply input and observe outputs.

- Apply an analog signal (2.51 M, -10 dBm) to any analog input SMA.
- The CW outputs (J12, J13) display the frequency I and Q signals at 10 kHz as shown in Figure 6. The GUI Gain Control Feedback Resistor can be used to vary the amplitude of the outputs.

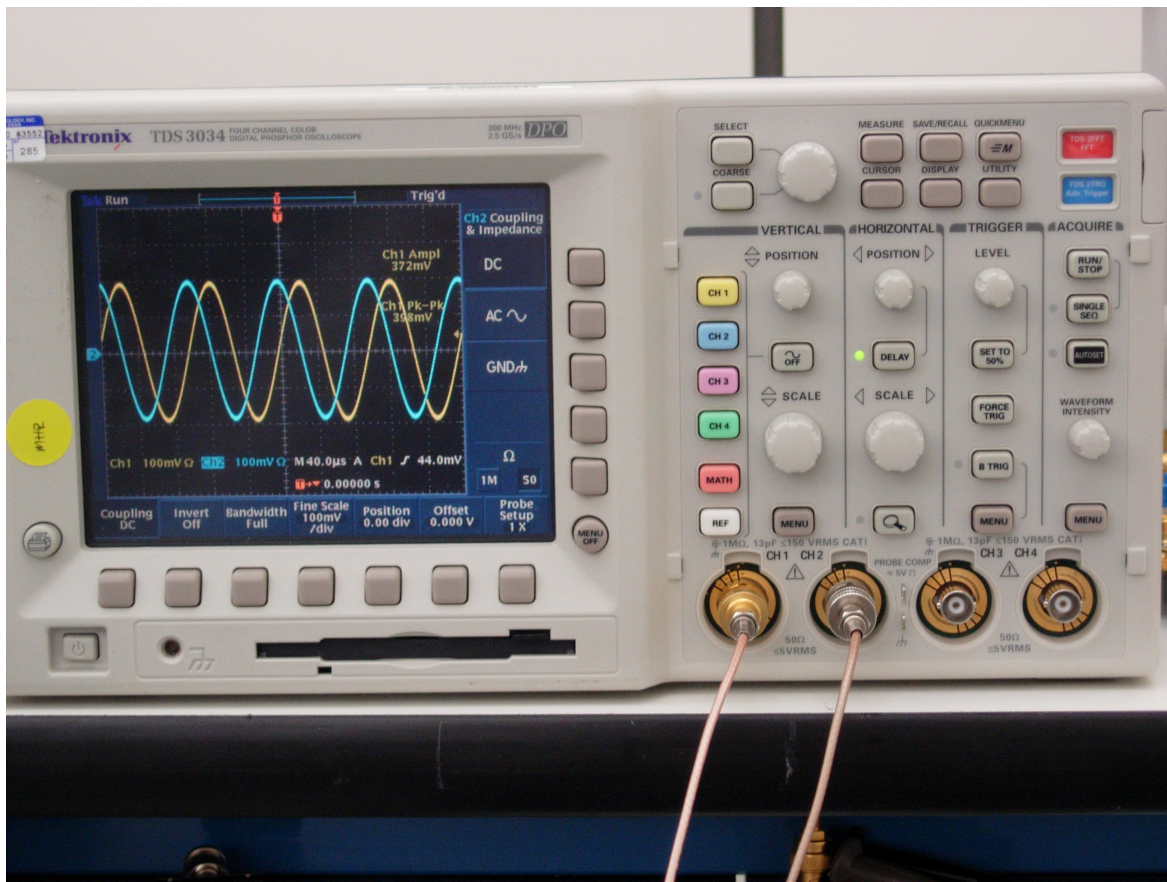

Figure 6. CW Outputs

9.3 External Clock for CW Mode

The CW mode clocks can be supplied from J9 (X16/X8/X4/X1) and J10 (X1) using external signal generators. The manufacture default setup uses ON BOARD CLOCK, with which C154, C155, C156, and C157 are installed. To switch to an external clock, these four capacitors must be uninstalled and capacitors C49,C50,C52, and C53 must be installed. The following table shows the configuration for these eight capacitors.

Table 1. Configuration for Clock Capacitors

Capacitor	Onboard Clock	External Clock	Comments
C49	Uninstalled	Installed	Top layer of the EVM
C50	Uninstalled	Installed	Bottom layer of the EVM
C52	Uninstalled	Installed	Bottom layer of the EVM
C53	Uninstalled	Installed	Top layer of the EVM
C154	Installed	Uninstalled	Top layer of the EVM
C155	Installed	Uninstalled	Top layer of the EVM
C156	Installed	Uninstalled	Top layer of the EVM
C157	Installed	Uninstalled	Top layer of the EVM

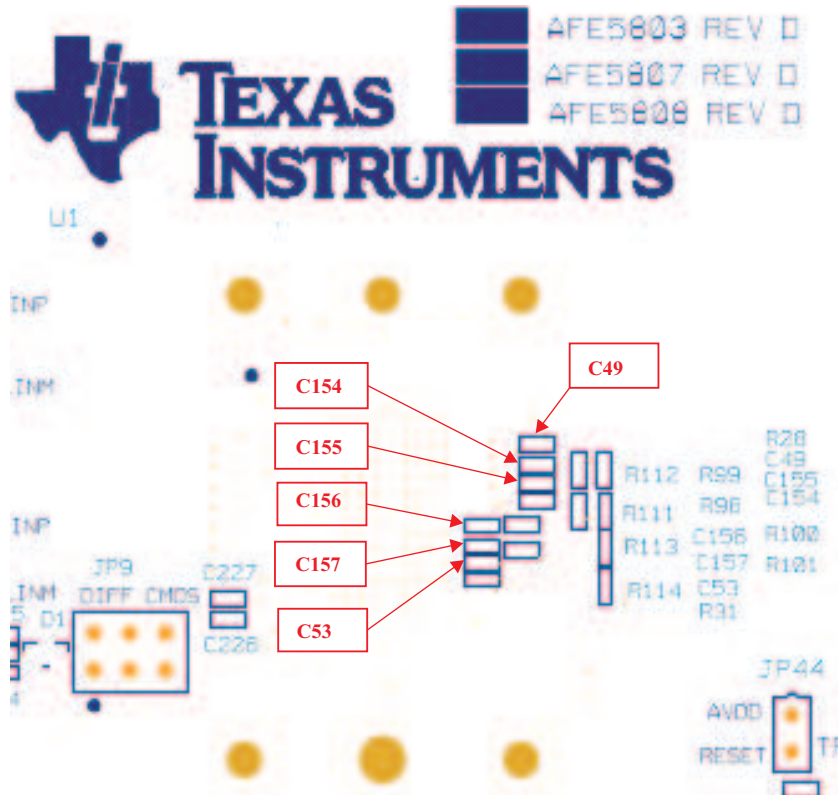

Figure 7. Relevant Capacitors for CW Mode, Top Side

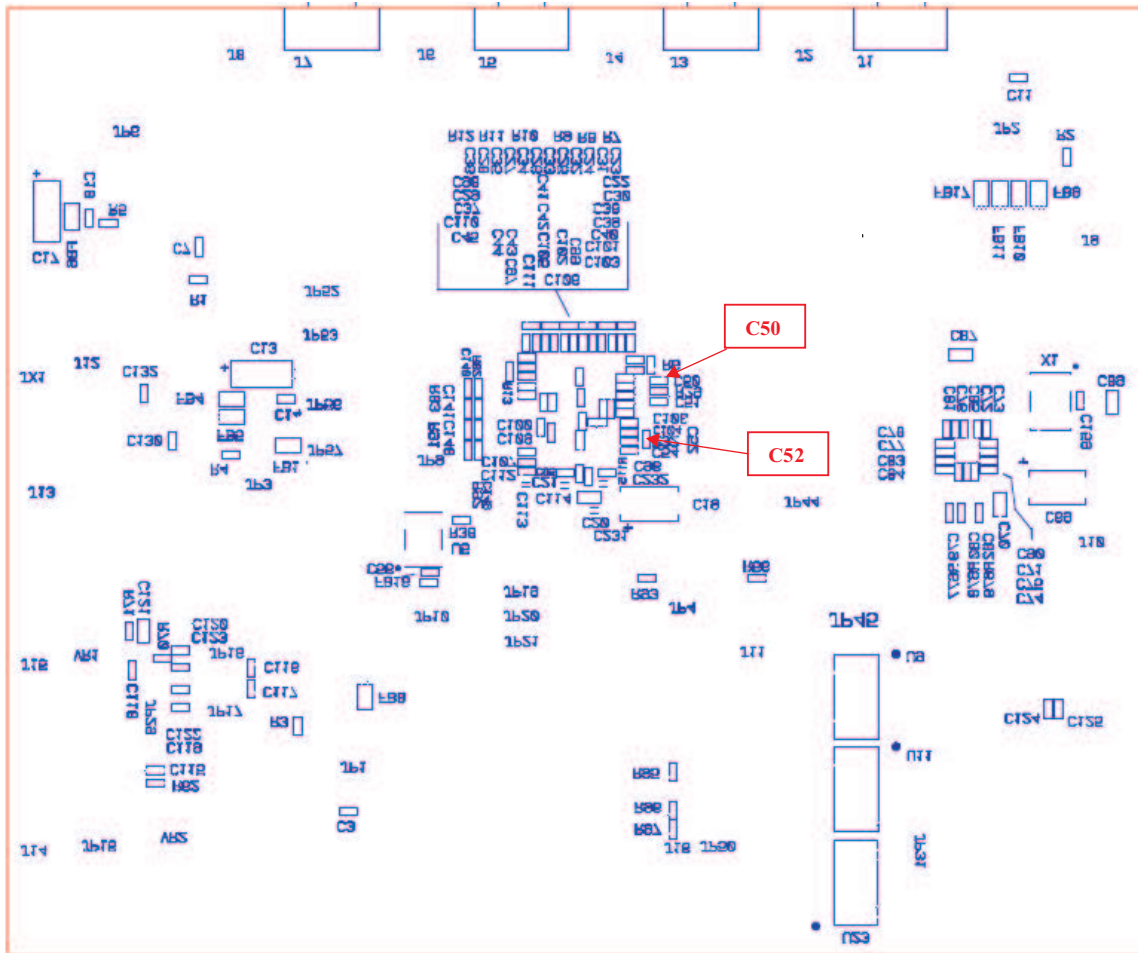

Figure 8. Relevant Capacitors for CW Mode, Bottom Side

10 External ADC Sampling Clock

To use the external clock generator to test the AFE5807/08, perform the following steps.

1. Reconfigure JP9 as shown in the following illustration. The rest of the jumpers remain the same.
2. Connect the external generator as shown in [Figure 9](#).
3. Set the generator output to 40 MHz, 13 dBm.

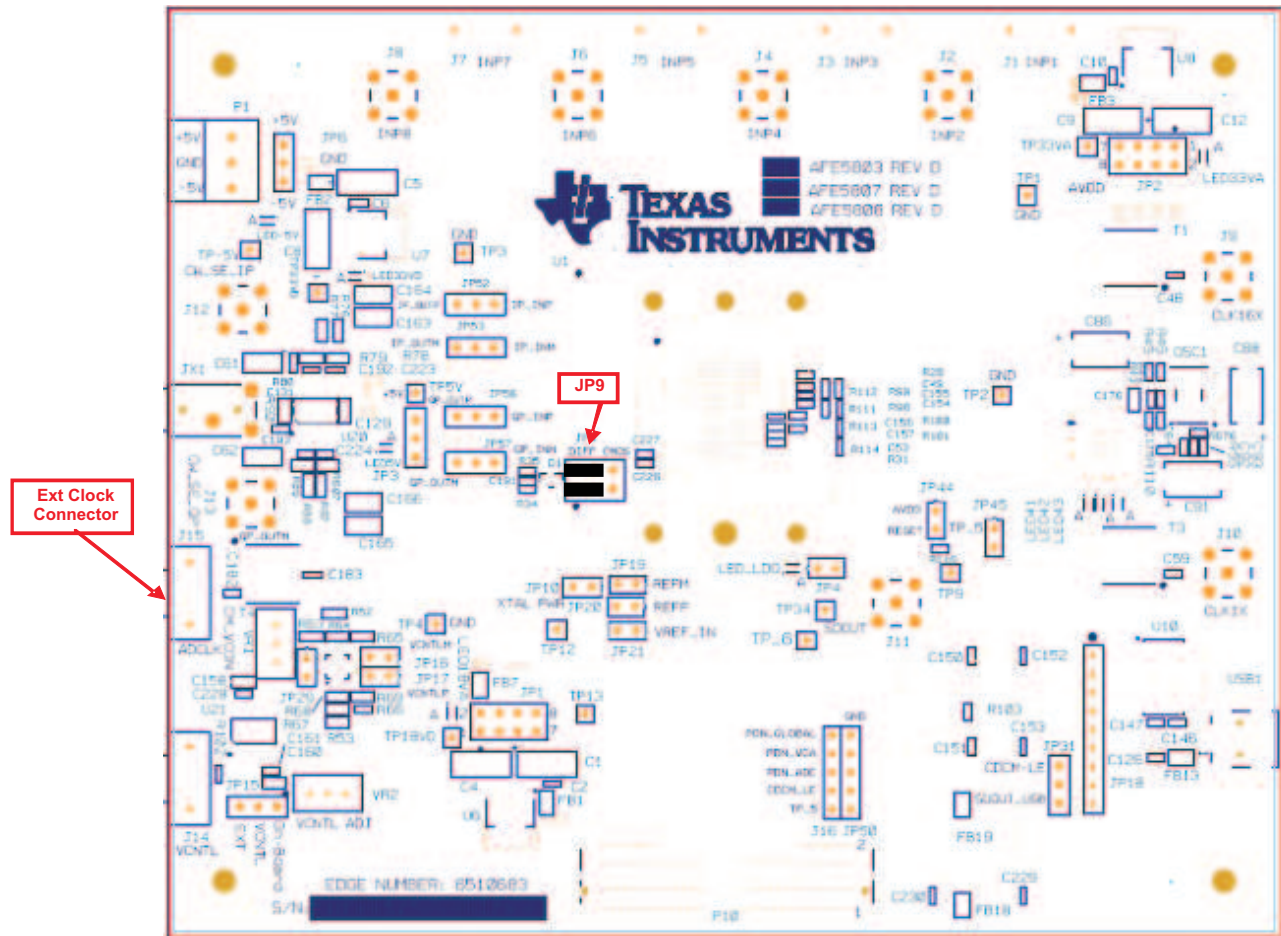
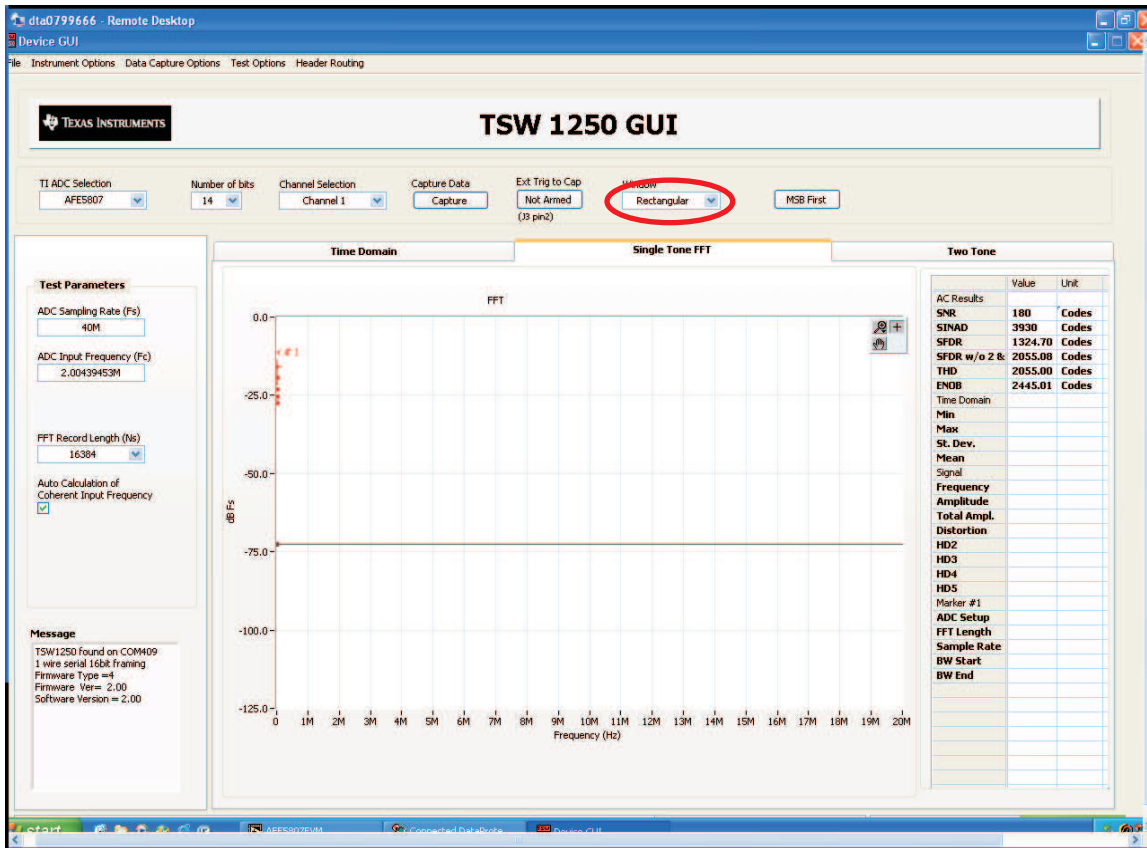

Figure 9. External ADC Sampling Clock Configuration

4. If the generators for the ADC clock and input signal are synchronous, then choose *Rectangular* as the Windowing option; otherwise, use *Hanning* or *Hamming*.



5. The test procedure is the same for the CMOS ADC clock.

11 External Vcntl

- JP15 needs to be reconfigured to short the leftmost two pins.
- A power supply is required to be connected as shown in [Figure 10](#).

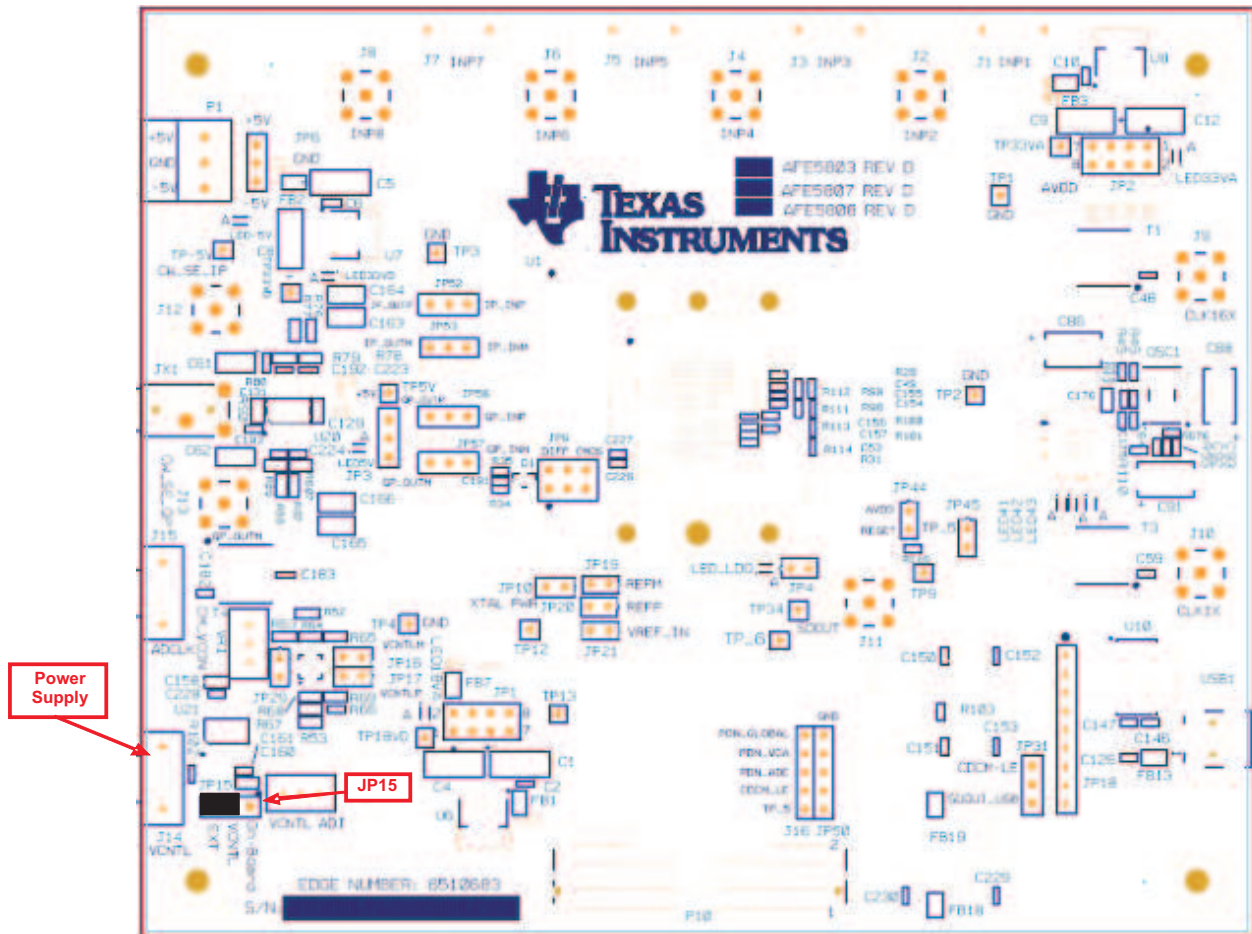

Figure 10. External Vcntl Configuration

12 Board Configuration

12.1 Input/Output, Power Supply, and USB

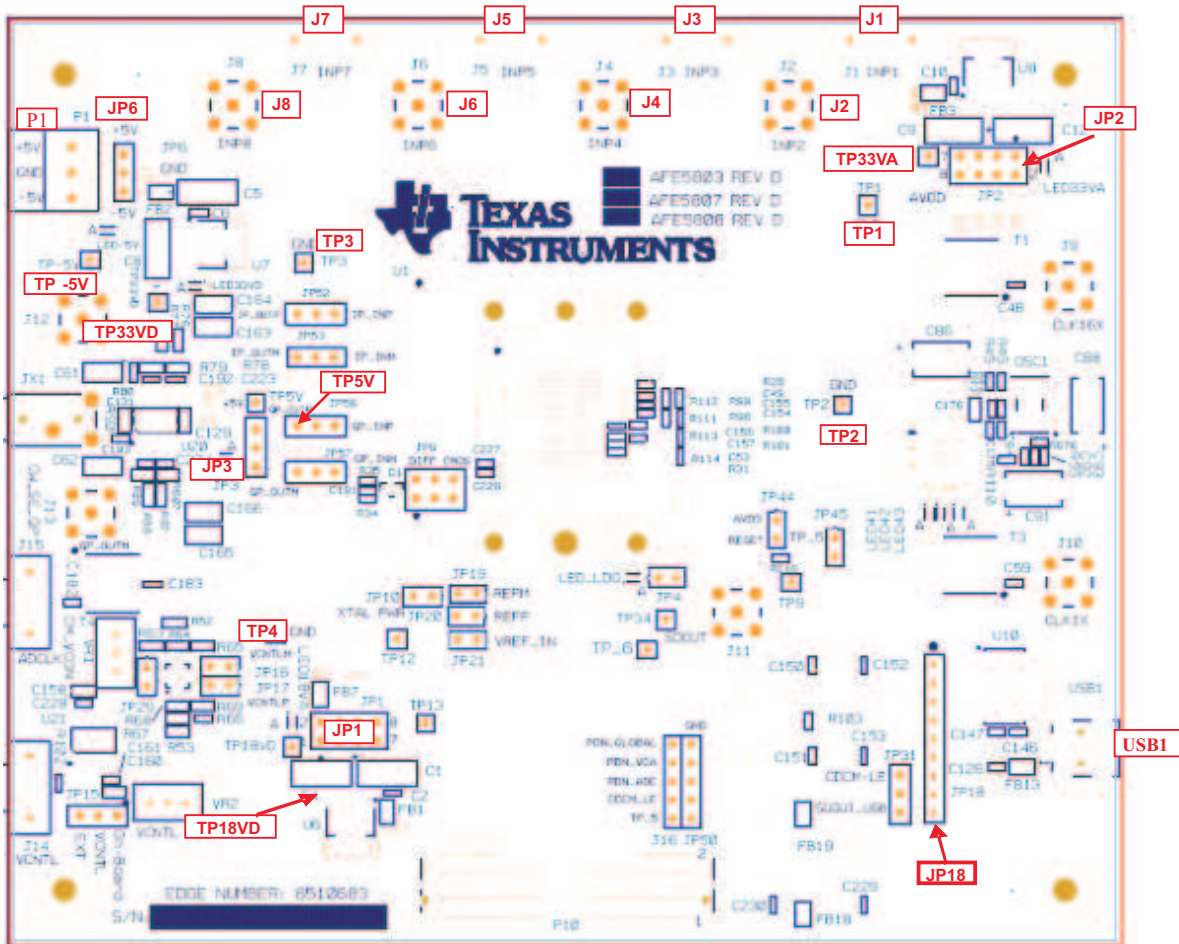

Figure 11. I/O, PWR, and USB Connector

Table 2. Input/Output, Power, and USB

Connector	Description
J1 through J8	Analog Input signals for Ch1 through Ch8. Connect to a signal generator. A bandpass filter must be applied between the generator and the SMA to get a better result. (See Figure 1 .)
P1/JP6	P1 is the +5-V and –5-V power supply connector. JP6 is the test point for +5-V/-5-V power supply.
JP3	Onboard 5-V enable. Set up as Figure 2 is a must to use onboard 5-V supply.
XP-5V	-5-V supply test point.
TP5V	+5-V supply test point.
JP1	Onboard +1.8-V enable. Set up as shown in Figure 2 ; required to use the onboard +1.8 V.
JP2	Onboard 3.3-VA enable. Set up as shown in Figure 2 ; required to use the onboard 3.3 V.
TP18VD	+1.8-VD supply test point.
TP33VD	+3.3-VD supply test point.
TP33VA	+3.3-VA supply test point.
TP1 through TP4	Ground test points.
USB1	USB interface connector
JP18	Test points for USB data bus: From pin 1 to pin 9 the signals are: D0, D4, D2, D1, D7, D5, D6, and D3

12.2 CW Mode, ADC Clock

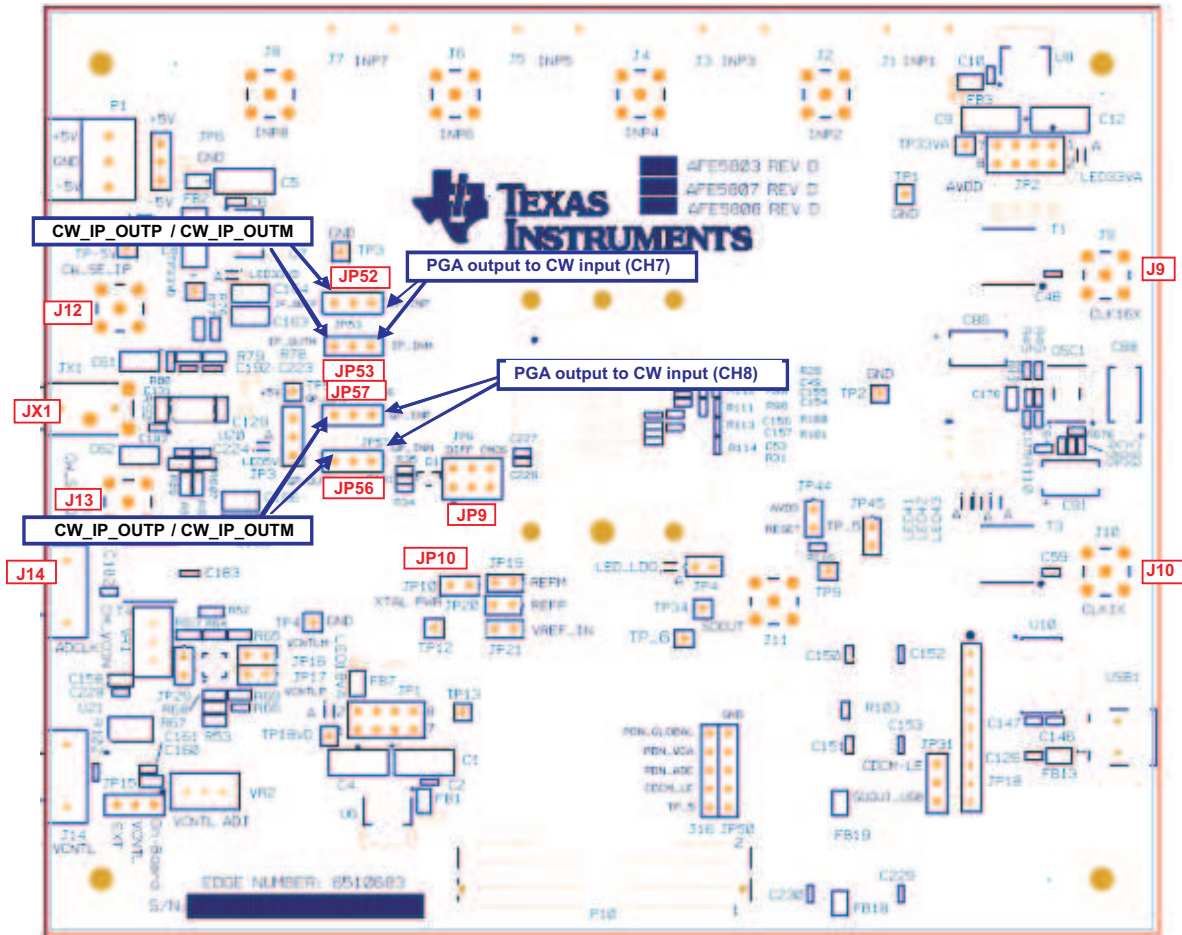

Figure 12. AFE5807/08EVM Jumper Locations

Table 3. CW Mode, ADC Clock

Clock Type	Reference Designator	Description
CW Mode	J9/J10	External CW Mode clock. The default is using onboard oscillator.
	J12 JP52/JP53	CW output for I-channel via an external operational amplifier. The EVM has converted the differential signal CW_IP_OUTP and CW_IP_OUTM into this single-ended output through an operational amplifier. To observe CW_IP_OUTP and CW_IP_OUTM before the external operational amplifier, the user can probe JP52 and JP53.
	J13 JP56/JP57	CW output for V-channel via an external operational amplifier. The EVM has converted the differential signal CW_VP_OUTP and CW_VP_OUTM into this single-ended output through an operational amplifier. To observe CW_VP_OUTP and CW_VP_OUTM before the external operational amplifier, the user can probe JP56 and JP57.
	JX1	This connector allows the user to see signals of J12 and J13 simultaneously.
ADC	JP9/JP10	JP9 selects on_board_ADC CMOS clock or external clock from J14. Default setup in Figure 4 uses onboard CMOS clock. Set it to the other side to use the external clock source.
		Short to power up onboard CMOS clock.
	J14	External ADC clock Input.

12.3 Vcntl Control Input

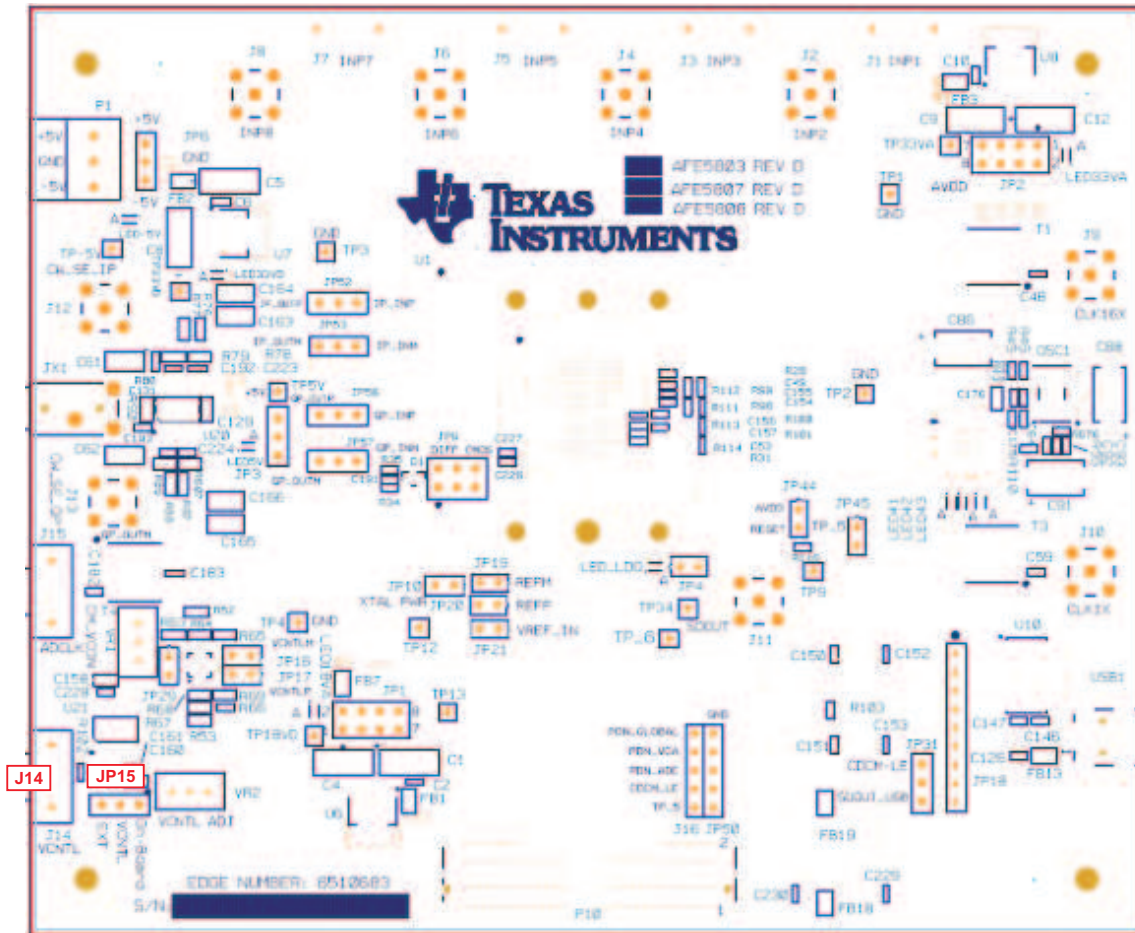

Figure 13. Vcntl

Table 4. CW Mode and Vcntl

Connector	Description
JP15	Choose onboard Vcntl or external Vcntl. The default setup uses onboard Vcntl.
J14	External Vcntl input. The range is from 0 V to 1.5 V.
VR2	Onboard Vcntl adjustment. Use JP15 pin 3 which has the text <i>On-Board</i> to monitor the Vcntl voltage level.

12.4 LEDs

The AFE5807/08EVM has seven LEDs. Their locations are shown in Figure 14. Their ON/OFF states demonstrate the normal operation of the power supplies and the PLL status of the clock buffer.

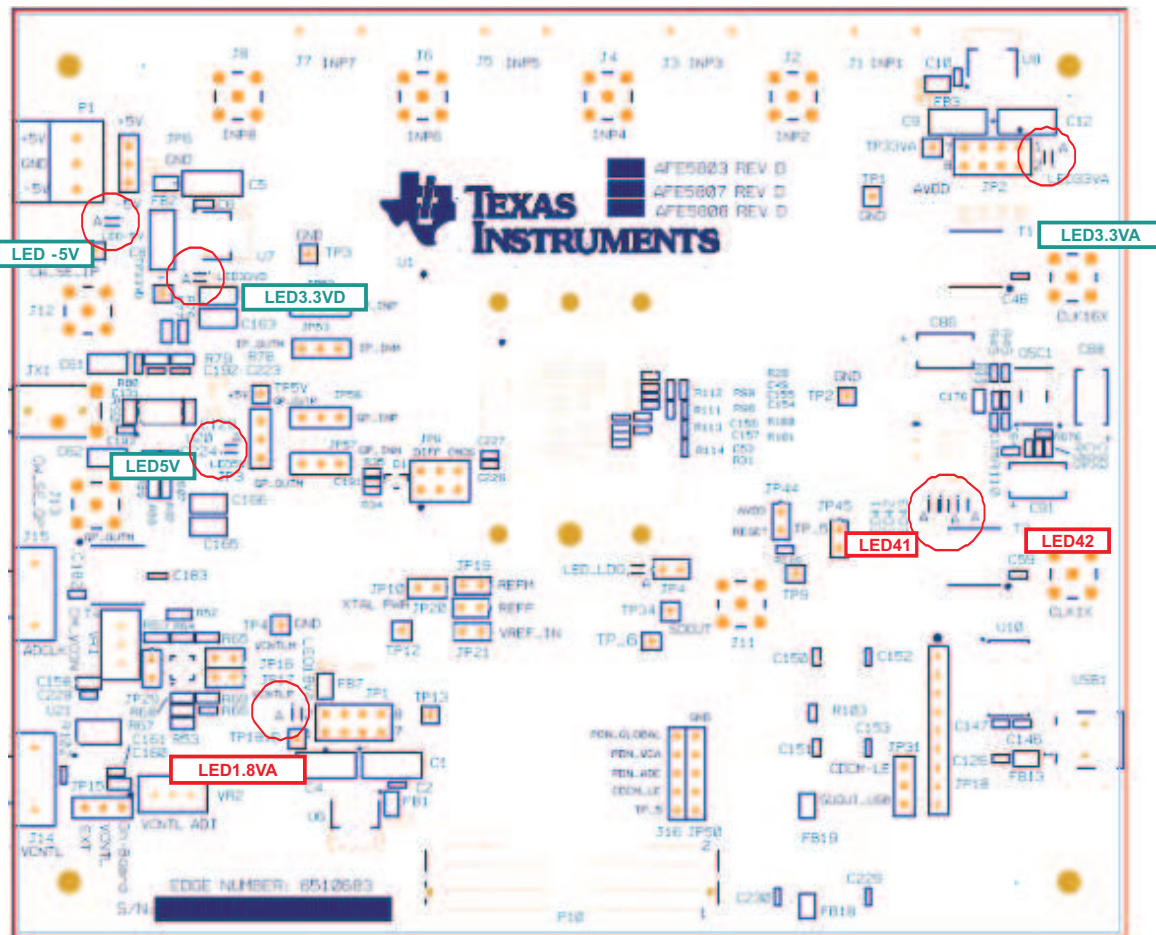

Figure 14. AFE5807/08EVM LED Location

Table 5. LED Indicators

Reference Designator	Power Supply	Color
LED-5V	-5 V	Green
LED5V	+5 V	Green
LED3.3VD	+3.3 VD	Orange
LED3.3VA	+3.3 VA	Green
LED1.8V	+1.8 VV	Green
LED41	Clock Buffer Status Indicator	Red
LED42		Red

12.5 Miscellaneous Test Points

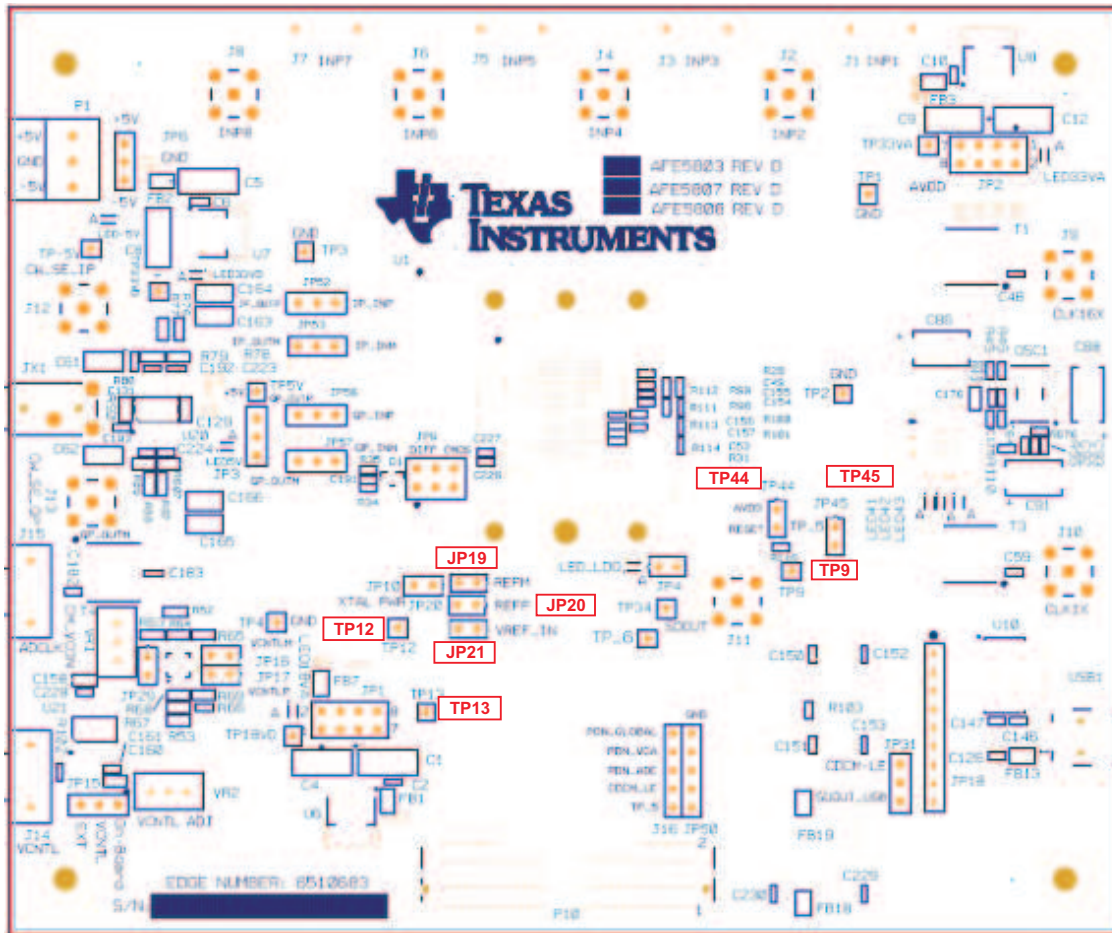

Figure 15. AFE5807/08EVM Test Point Locations

Table 6. Test Points

Reference Designator	Description
TP9, TP12, TP13, TP34	AFE5807/08 device test pin M8, L5, M5, and M9
JP19	REFM voltage input
JP31	SDOUT read enable
JP44	RESET input. Short to reset AFE5807.
JP45	TP_5 control enable
JP20	REFP voltage input
JP21	REF_IN voltage input

13 EVM Printed-Circuit Board Layouts and Schematics

The following illustrations show the six layers of the AFE5807/08EVM board.

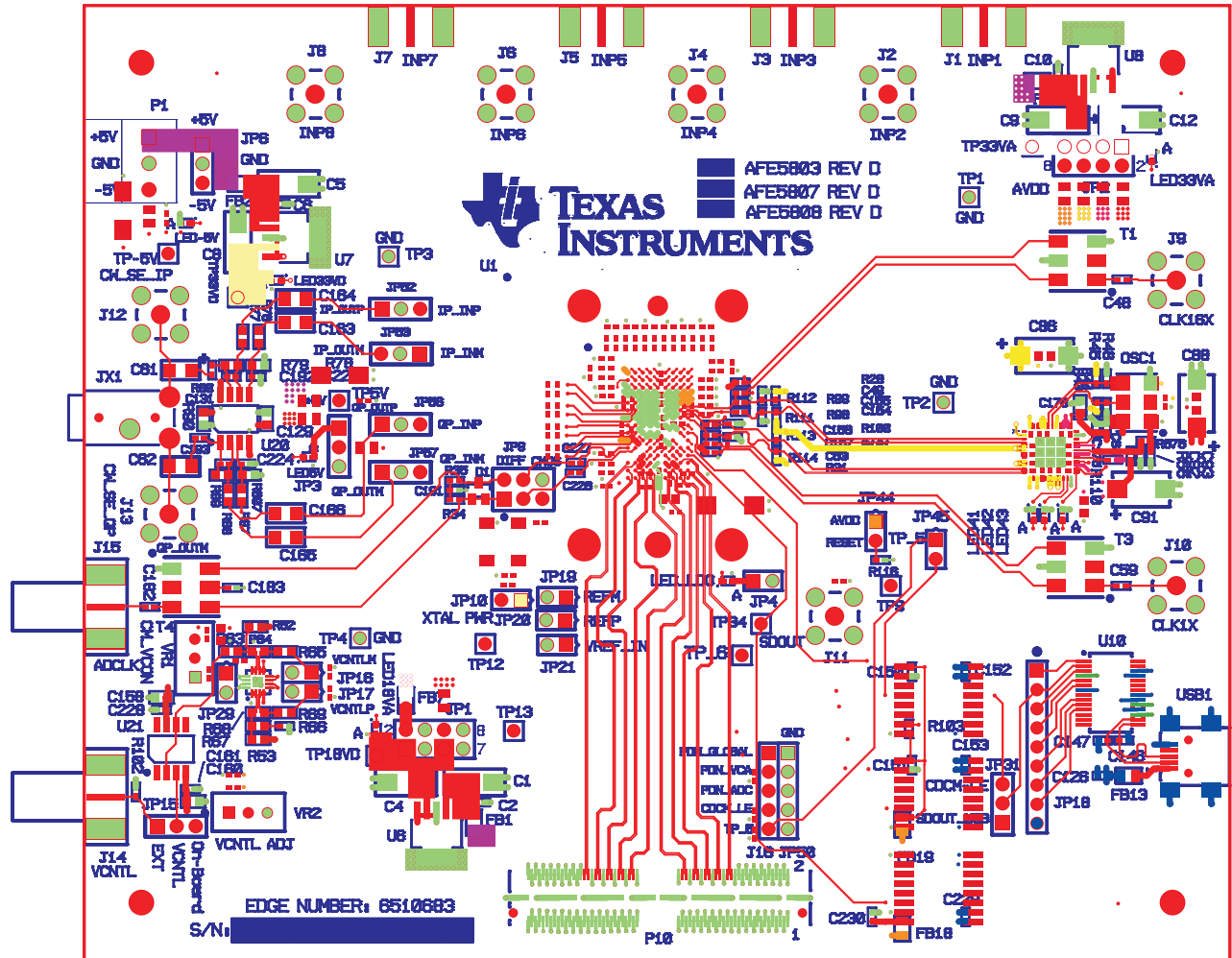

Figure 16. Top Layer - Signal

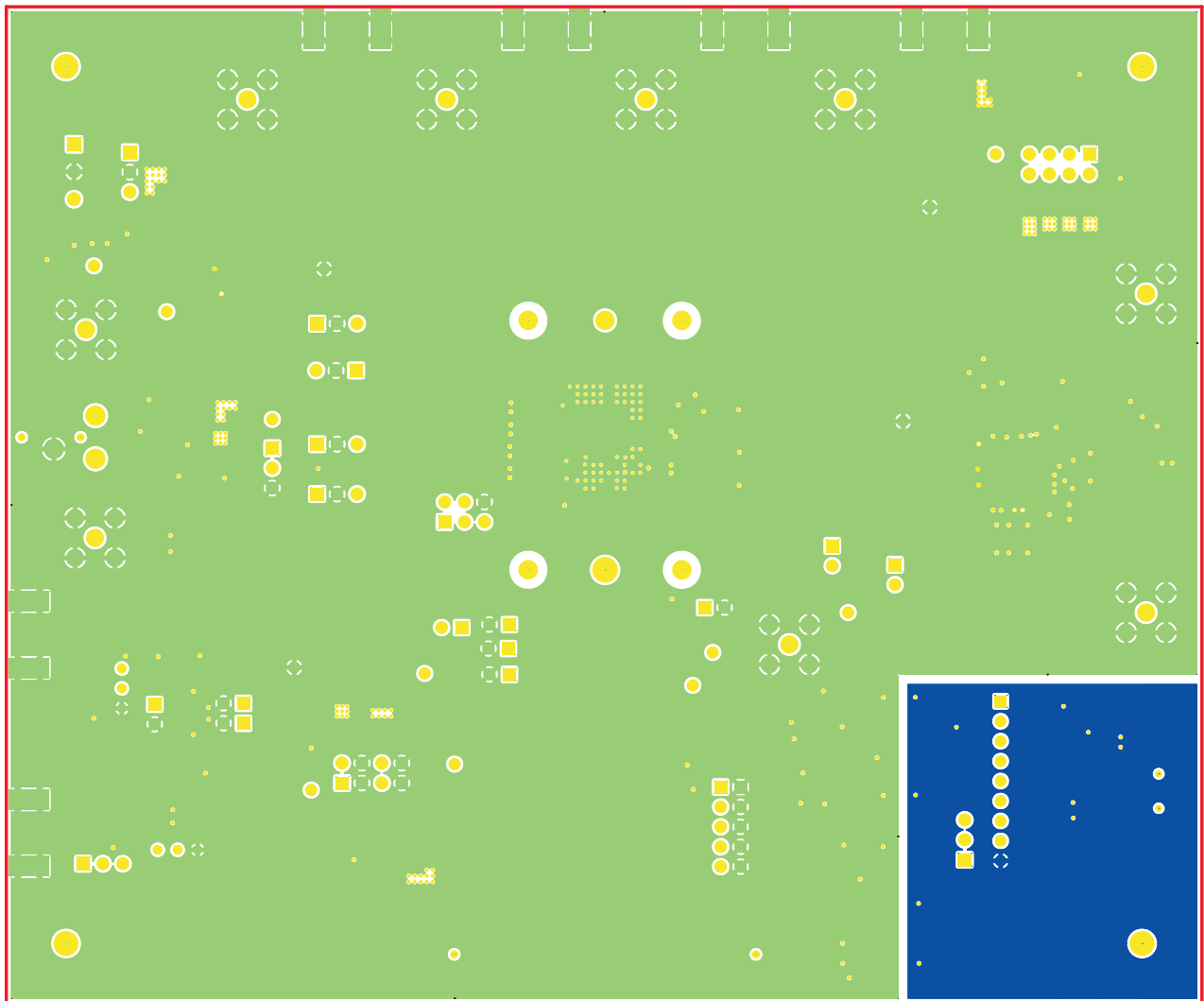

Figure 17. Second Layer - Ground

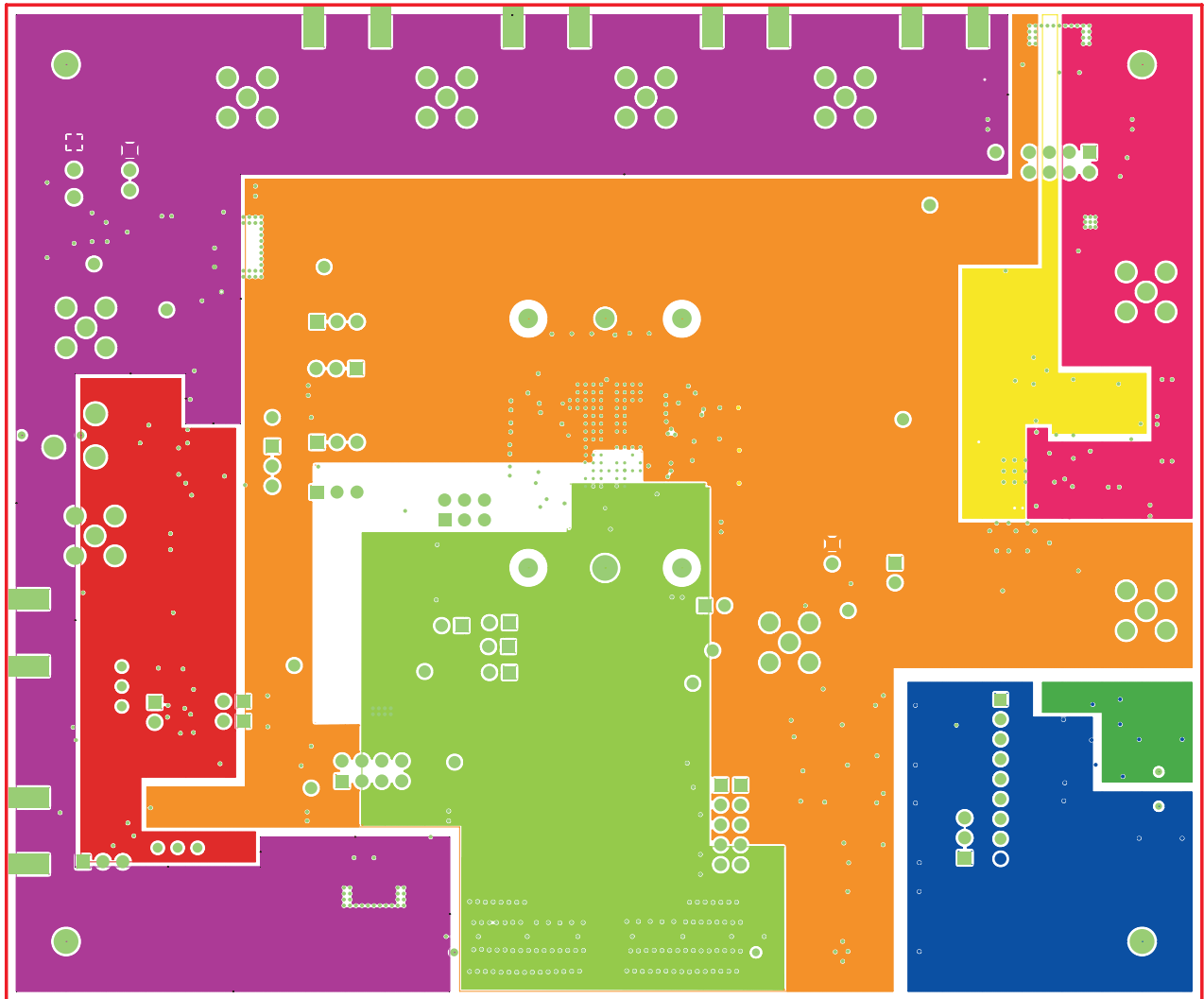

Figure 18. Third Layer - Power

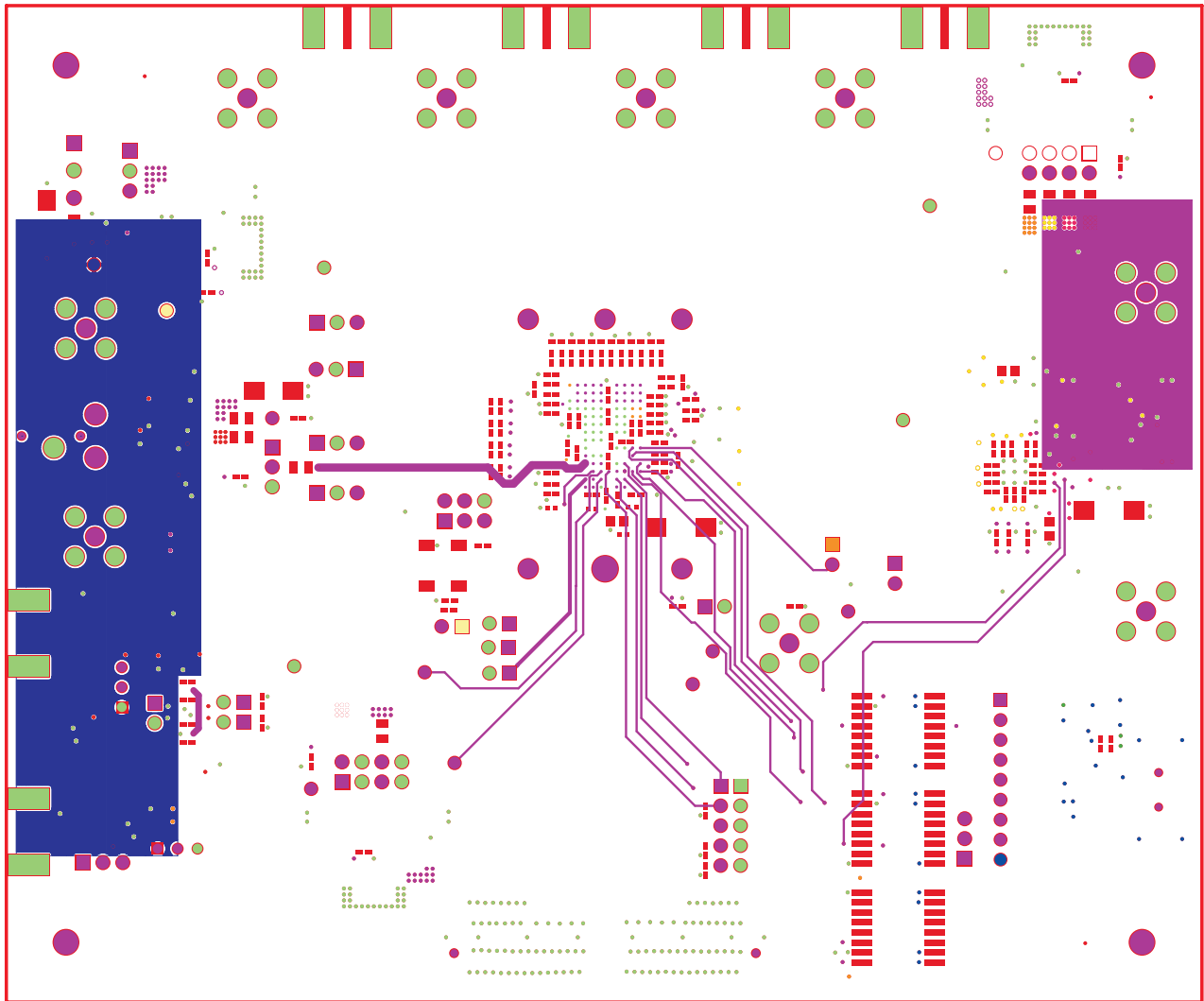

Figure 19. Fourth Layer - Signal

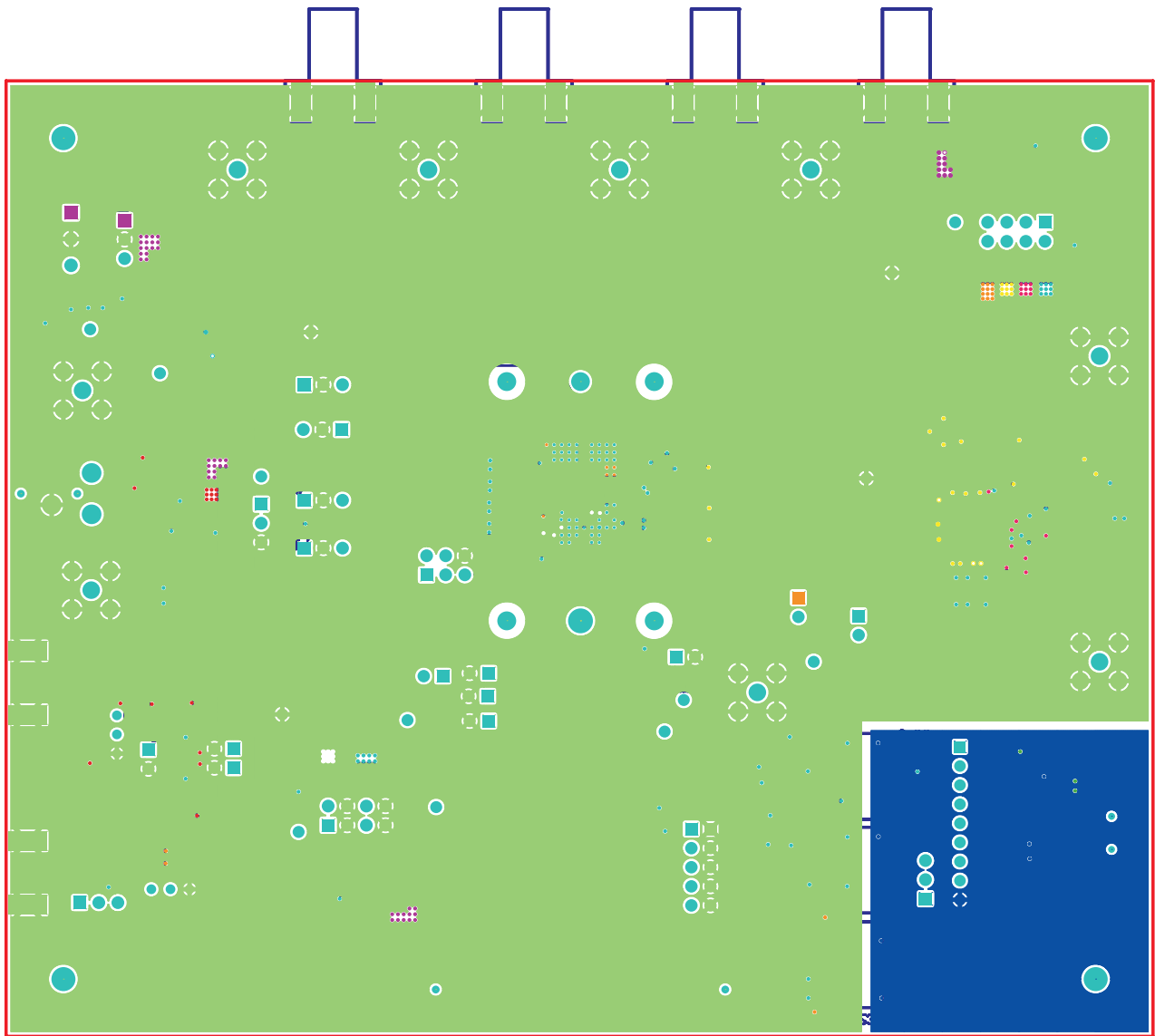

Figure 20. Fifth Layer - Ground

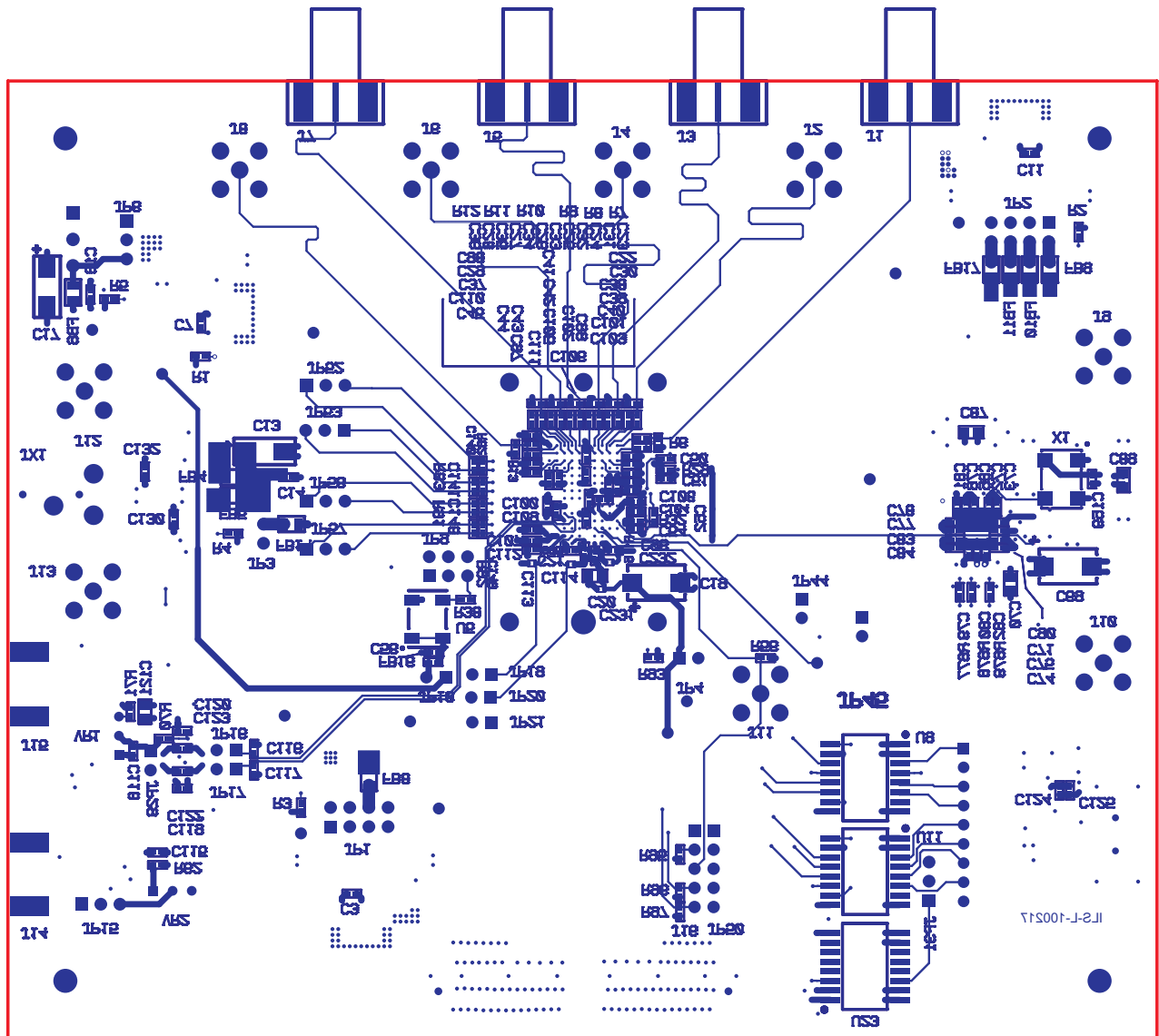

Figure 21. Bottom Layer - Signal

The schematic sheets are appended to the end of this document.

14 Bill of Materials

Table 7. Bill of Materials

QTY	MFG	MFG PART No.	REF DES	DESCRIPTION	VALUE OR FUNCTION
89	AVX	0402YC104KAT2A	C21, C22, C23, C24, C25, C26, C27, C28, C29, C30, C31, C32, C33, C34, C35, C36, C37, C48, C49, C50, C51, C52, C53, C54, C59, C64, C71, C72, C73, C74, C75, C76, C77, C78, C79, C80, C81, C82, C83, C84, C85, C90, C95, C96, C97, C98, C99, C100, C101, C102, C103, C104, C105, C106, C107, C108, C109, C112, C115, C116, C117, C118, C119, C120, C122, C123, C124, C125, C126, C130, C132, C150, C151, C152, C153, C154, C155, C156, C157, C159, C161, C182, C183, C191, C226, C227, C228, C229, C230	CAP,SMT,0402	CAPACITOR, SMT ,0402, CER, 16V, 10%, 0.1uF DO NOT INSTALL C49, C50, C116, C117, C52, C53
4	AVX	0402YC332KAT2A	C192, C193, C223, C224	CAP,SMT,0402	CAPACITOR, SMT, 0402, CER, 16V, 10%, 3300pF
9	KEMET	C0402C104K8PAC	C2, C3, C6, C7, C10, C11, C14, C18, C56	CAP,SMT,0402	CAPACITOR, SMT, 0402, CER, 0.1uF, 10V, 10%, X5R
4	ANY	C0402_PAD020X020_040LS(UN)	C113, C114, C231, C232	CAP,SMT,0402	CAP,0402, ALTERNAT FOOTPRINT, PAD 020x020, 040LS (Uninstalled Part)
8	PANASONIC	ECJ-0EB1C153K	C38, C39, C40, C41, C42, C43, C44, C45	CAP,SMT,0402	CAPACITOR, SMT, 0402, CERAMIC, 0.015uF, 16V, 10%, X7R
1	PANASONIC	ECJ-0EB1H102K	C175	CAP,SMT,0402	CAPACITOR, SMT, 0402, CER, 1000pF, 50V, 10%, X7R
4	PANASONIC	ECJ-0EB1H332K	C140, C141, C148, C149	CAP,SMT,0402	CAPACITOR, SMT, 0402, CER, 3300pF, 50V, 10%, X7R
2	PANASONIC	ECJ-0EC1H470J	C146, C147	CAP,SMT,0402	CAPACITOR, SMT, 0402, CER, 47pF, 50V, 5%, NPO
2	TAIYO YUDEN	LMK105F104ZV	C92, C93	CAP,SMT,0402	CAPACITOR, SMT, 0402, CERAMIC, 10V, Y5V, 0.1uF, 20% DO NOT INSTALL
2	PANASONIC	ECJ-0EB1A105M	C110, C111	CAP,SMT,0402	CAPACITOR, SMT, 0402, CERAMIC, 1.0uF, 10V, 20%, X5R
5	AVX	0603YD105KAT2A	C121, C129, C131, C158, C160	CAP,SMT,0603	CAPACITOR, SMT, 0603, CERAMIC, 1.0uF, 16V, 10%, X5R
4	PANASONIC	ECJ-1VB1C105K	C20, C70, C87, C89	CAP,SMT,0603	CAPACITOR, SMT, 0603, CERAMIC, 1.0uF, 16V, 10%, X5R
1	TAIYO YUDEN	JMK107BJ106MA-T	C176	CAP,SMT,0603	CAPACITOR, SMT, 0603, CERAMIC, 10uF, 6.3V, 20%,X5R
6	KEMET	C1206C226K8PAC	C61, C62, C163, C164, C165, C166	CAP,SMT,1206	CAPACITOR, SMT, 1206, CERAMIC, 22uF, 10V, 10%, X5R
5	VISHAY SPRAGE	293D226X9016D2T	C19, C69, C86, C88, C91	CAP,SMT,7343	CAP, TAN, SMT, 22uF, 16V, +/-10%, -55-85C DO NOT INSTALL C91
8	AVX	TPSC226K016R0375	C1, C4, C5, C8, C9, C12, C13, C17	CAPACITOR, SMT, TANT	10%, 16V, 22uF
1	ADVANCED CONNECTEK	MNE20-5K5P10	USB1	CONN,SMT,5P	MINI-AB USB OTG RECEPTACLE R/A SMT TYPE
6	EF JOHNSON	142-0721-891	J1, J3, J5, J7, J14, J15	CONN, THU, SMA JACK	SMA JACK END LAUNCH, 0.080 PCB THICK
9	AMPHENOL	901-144-8	J2, J4, J6, J8, J9, J10, J11, J12, J13	CONNECTOR, SMA	SMA COAX STRAIGHT PCB CURRENT P/N IS 901-144-8RFX
1	*YOKOWO SEMICONDUCTOR TEST	SB5549-0000-E-1(SP)	U1	CUSTOMER PROVIDE	HTSOCKET, SMT, 135P, BGA, 1mmLS, 022PAD (CUSTOMER PROVIDE)
1	INFINEON	BAT68-04(UN)	D1	DIODE,SMT,SOT23-3	SILICON SCHOTTKY DIODES, SMT, SOT23-3, DUAL, 8V, 130mA, 150mW (UNI)
1	MURATA	BLM15BD102SN1D	FB16	FERRITE BEAD,SMT,0402	FERRITE BEAD, SMT, 0402, 1K OHM, 200mA
16	STEWART	HI0805R800R-00	FB1, FB2, FB3, FB4, FB5, FB6, FB7, FB8, FB9, FB10, FB11, FB13, FB14, FB17, FB18, FB19	FERRITE BEAD,SMT,2P	FERRITE, SMT, 0805, 80 OHM @100MHz, 5A
1	MOLEX	39357-0003	P1	HEADER, THRU, 3P	HEADER, THRU, POWER, 3P, 3.5MM, EUROSTYLE
1	SAMTEC	QTH-060-01-L-D-A	P10	HEADER, SMT, 120P	HEADER, SMT, 120P, 0.5mm, FEM, 2BANK, RECEPTACLE, 168/198H
1	SAMTEC	TSW-103-07-G-D	JP9	HEADER, THU	HEADER, THU, 6P, 2X3, MALE, DUAL ROW, 100LS, 100TL
2	SAMTEC	TSW-104-07-G-D	JP1, JP2	HEADER, THU	HEADER, THU, 8P, 2X4, MALE, DUAL ROW, 100LS, 100TL
2	TYCO ELECTRONICS	4-103239-0X5	J16, JP50	HEADER,THU,5P	HEADER, 1X5, .1CTRS
1	SPC TECH	8431-1x9	JP18	HEADER,THU,9P	HEADER, THU, MALE, 0.1LS, 9P, 1X9, 335H, 120TL

Table 7. Bill of Materials (continued)

QTY	MFG	MFG PART No.	REF DES	DESCRIPTION	VALUE OR FUNCTION
10	TYCO ELECTRONICS	4-103239-0x2	JP4, JP10, JP16, JP17, JP19, JP20, JP21, JP29, JP44, JP45	HEADER, THU, JUMPER	MALE, 2PIN, .100CC MAKE FROM 4-103239-0x2
8	TYCO ELECTRONICS	4-103239-0x3	JP3, JP6, JP15, JP31, JP52, JP53, JP56, JP57	HEADER, THU, JUMPER	MAKE FROM 4-103239-0
1	TI	THS4520RGT	VCON_OPAMP	IC, SMT, QFN-16EP	WIDEBAND, LOW NOISE/DISTORTION FULLY DIFFERENTIAL AMPLIFIER
1	TEXAS INSTRUMENTS	CDCM7005RGZ	CLK_BUF	IC, SMT, QFN-48	3.3-V HIGH PERFORMANCE CLOCK SYNTHESIZER AND JITTER CLEANER
3	TI	ISO7240MDW	U9, U11, U23	IC, SMT, SOIC-16W	QUAD DIGITAL ISOLATORS
1	TI / BURR-BROWN	OPA211AID	U21	IC, SMT, SOIC-8	1.1nV/Hz NOISE LOW POWER PRECISION OPERATIONAL AMPLIFIER
1	TI	OPA2614ID	U20	IC, SMT, SOIC-8	DUAL HI GAIN BWIDTH HI OUTPUT CURRENT OPAMP WITH CURRENT LIMIT
1	TI	TPS79618DCQR	U6	IC, SMT, SOT223-6	ULTRALOW-NOISE HI PSRR FAST RF 1-A LDO LINEAR REGULATOR, 1.8V
2	TI	TPS79633DCQR	U7, U8	IC, SMT, SOT223-6	ULTRALOW-NOISE HI PSRR FAST RF 1-A LDO LINEAR REGULATOR, 3.3V
1	FUTURE TECHNOLOGY DEVICE INT.	FT245RL	U10	IC, SMT, SSOP-28	USB FIFO IC INCORPORATE FTDICHIP-ID SECURITY DONGLE
3	PANASONIC	LNJ208R82RA	LED41, LED42, LED43	LED, SMT, 0603	LED, SMT, 0603, ULTRA BRIGHT RED, 1.92V
5	PANASONIC	LNJ308G8PRA	LED-5V, LED33VA, LED33VD, LED5V, LED_LDO	LED, SMT, 0603	LED, SMT, 0603, PURE GREEN, 2.03V
1	PANASONIC	LNJ808R8ERA	LED18VA	LED, SMT, 0603	LED, SMT, 0603, ORANGE, 1.8V
1	CONNOR WINFIELD	CWX813-10.0M	X1	OSC, SMT, 4P	OSCILLATOR, SMT, 4P, 3.3V, +/-25ppm, -20-70C, 10.000 MHz
1	OSC, SMT, 4P	VCC1-B3B-40M000000	OSC1	OSC, SMT, 6P	OSCILLATOR, SMT, 3.3V40Mhz 5.0x7.5x1.8mm
1	ECS	ECS-3953M-400-BN	U5	OSCILLATOR, SMT, 4P	OSC,SMT, 3.3V, 50ppm, -40-85C, 5nS, 40.000 MHz
1	VENKEL	CR0402-16W-000T	R70	RES, SMT, 0402	RESISTOR, SMT, 0402,0 OHM, 1/16W, ZERO JUMPER
4	VISHAY	CRCW0402000Z(UN)	R95, R96, R97, R115	RES, SMT, 0402	(UNINSTALLED PART)
2	VISHAY	CRCW04021001F100	R103, R116	RES, SMT, 0402	RESISTOR, SMT, 0402, 1K, 1/16W, 1%, 100ppm
1	VISHAY	CRCW04021002F100	R62	RES, SMT, 0402	RESISTOR, SMT, 0402, 10K, 1/16W, 1%, 100ppm
2	VISHAY	CRCW04022002F100	R71, R110	RES, SMT, 0402	RESISTOR, SMT, 0402, 20K, 1/16W, 1%,100ppm
1	VISHAY	CRCW04024701F100	R55	RES, SMT, 0402	RESISTOR, SMT, 0402, 4.7K, 1/16W, 1%, 100ppm DO NOT INSTALL
3	VISHAY	CRCW04024990F100	R677, R678, R679	RES, SMT ,0402	RESISTOR, SMT, 0402, 499 OHM, 1/16W, 1%, 100ppm
1	VISHAY	CRCW04025110F100	R5	RES, SMT, 0402	RESISTOR, SMT, 0402, 511 OHM, 1/16W, 1%, 100ppm
1	PANASONIC	ERJ-2GE0R00X	R66	RES, SMT, 0402	RESISTOR/JUMPER, SMT, 0402, 0 OHM, 5%, 1/16W
1	PANASONIC	ERJ-2GEJ131	R45	RES, SMT, 0402	RESISTOR, SMT, 0402, THICK FILM, 5%, 1/16W, 130 DO NOT INSTALL ,R45
5	PANASONIC	ERJ-2GEJ131	R43, R111, R112, R113, R114	RES, SMT, 0402	RESISTOR, SMT, 0402, THICK FILM, 5%, 1/16W, 130 , R45
1	PANASONIC	ERJ-2GEJ161	R676	RES, SMT, 0402	RESISTOR, SMT, 0402, THICK FILM, 5%, 1/16W, 160 DO NOT INSTALL
4	PANASONIC	ERJ-2GEJ499	R82, R83, R91, R92	RES, SMT, 0402	RESISTOR, SMT, 0402, THICK FILM, 5%, 1/16W, 499 DO NOT INSTALL
8	PANASONIC	ERJ-2GEJ49R9(UN)	R6, R7, R8, R9, R10, R11, R12, R13	RES, SMT ,0402	(UNINSTALLED PART)
1	PANASONIC	ERJ-2GEJ820	R46	RES, SMT, 0402	RESISTOR, SMT, 0402, THICK FILM, 5%, 1/16W, 82 DO NOT INSTALL R46
5	PANASONIC	ERJ-2GEJ820	R44, R98, R99, R100, R101	RES, SMT, 0402	RESISTOR, SMT, 0402,THICK FILM, 5%, 1/16W, 82 R46
8	PANASONIC	ERJ-2RKF1000X	R4, R28, R29, R31, R32, R34, R35, R93	RES, SMT, 0402	RESISTOR, SMT, 0402, 100 OHM, 1%, 1/10W
3	PANASONIC	ERJ-2RKF3320X	R1, R2, R3	RES, SMT, 0402	RESISTOR, SMT, 0402, 332 OHM, 1%, 1/16W
5	PANASONIC	ERJ-2RKF49R9X	R38, R56, R80, R90, R102	RES, SMT, 0402	RESISTOR, SMT, 0402, 49.9 OHM, 1%, 1/16W
2	VISHAY	CRCW0603200F	R65, R69	RES, SMT, 0603	RESISTOR, SMT, 0603, 1%, 1/10W, 200 OHM
2	VISHAY	CRCW0603487F	R63, R67	RES, SMT, 0603	RESISTOR, SMT, 0603, 1%, 1/10W, 487 OHM
2	VISHAY	CRCW0603511F	R52, R53	RES, SMT, 0603	RESISTOR, SMT, 0603, 1%, 1/10W, 511 OHM
2	PANASONIC	ERJ-3GSYJ499	R64, R68	RES, SMT, 0603	RESISTOR, SMT, 0603, 1%, 1/10W, 499
8	VISHAY	TNPW06034990BT9	R76, R77, R78, R79, R87, R88, R89, R607	RES, SMT, 0603	RESISTOR, SMT, 0603, THIN FILM, 499 OHM 0.1%, 1/10W, 25ppm
1	KYCON	STX-3000	JX1	STEREO PHONE JACK, THU, 3 PIN	STEREO PHONE JACK, THU, 3 PIN, 3.5mm

Table 7. Bill of Materials (continued)

QTY	MFG	MFG PART No.	REF DES	DESCRIPTION	VALUE OR FUNCTION
5	KEYSTONE ELECTRONICS	5000	TP_6, TP18VD, TP33VA, TP33VD, TP5V	TESTPOINT, THU, 1P	TESTPOINT, THU, MINIATURE, 0.1LS, 120TL, RED
4	KEYSTONE ELECTRONICS	5001	TP1, TP2, TP3, TP4	TESTPOINT, THU, 1P	TESTPOINT, THU, MINIATURE, 0.1LS, 120TL, BLACK
1	KEYSTONE ELECTRONICS	5002	TP-5V	TESTPOINT, THU, 1P	TESTPOINT, THU, MINIATURE, 0.1LS, 120TL, WHITE
4	KEYSTONE ELECTRONICS	5004	TP9, TP12, TP13, TP34	TESTPOINT, THU, 1P	TESTPOINT, THU, MINIATURE, 0.1LS, 120TL, YELLOW
3	MINI-CIRCUITS	ADT4-1WT	T1, T3, T4	TRANSF, SMT, 6P	RF TRANSFORMER WIDEBAND, 2-775 MHz, 50 OHM
1	BOURNS	3296W-1-103	VR2	TRIMPOT, THU, 3P	TRIMPOT, THU, 10K, 10%, 0.5W, 100ppm, 25T
1	BOURNS	3296W-1-205	VR1	TRIMPOT, THU, 3P	TRIMPOT, THU, 2M, 10%, 0.5W, 100ppm, 25T
SPECIAL NOTES AND INSTRUCTIONS					

Evaluation Board/Kit Important Notice

Texas Instruments (TI) provides the enclosed product(s) under the following conditions:

This evaluation board/kit is intended for use for **ENGINEERING DEVELOPMENT, DEMONSTRATION, OR EVALUATION PURPOSES ONLY** and is not considered by TI to be a finished end-product fit for general consumer use. Persons handling the product(s) must have electronics training and observe good engineering practice standards. As such, the goods being provided are not intended to be complete in terms of required design-, marketing-, and/or manufacturing-related protective considerations, including product safety and environmental measures typically found in end products that incorporate such semiconductor components or circuit boards. This evaluation board/kit does not fall within the scope of the European Union directives regarding electromagnetic compatibility, restricted substances (RoHS), recycling (WEEE), FCC, CE or UL, and therefore may not meet the technical requirements of these directives or other related directives.

Should this evaluation board/kit not meet the specifications indicated in the User's Guide, the board/kit may be returned within 30 days from the date of delivery for a full refund. **THE FOREGOING WARRANTY IS THE EXCLUSIVE WARRANTY MADE BY SELLER TO BUYER AND IS IN LIEU OF ALL OTHER WARRANTIES, EXPRESSED, IMPLIED, OR STATUTORY, INCLUDING ANY WARRANTY OF MERCHANTABILITY OR FITNESS FOR ANY PARTICULAR PURPOSE.**

The user assumes all responsibility and liability for proper and safe handling of the goods. Further, the user indemnifies TI from all claims arising from the handling or use of the goods. Due to the open construction of the product, it is the user's responsibility to take any and all appropriate precautions with regard to electrostatic discharge.

EXCEPT TO THE EXTENT OF THE INDEMNITY SET FORTH ABOVE, NEITHER PARTY SHALL BE LIABLE TO THE OTHER FOR ANY INDIRECT, SPECIAL, INCIDENTAL, OR CONSEQUENTIAL DAMAGES.

TI currently deals with a variety of customers for products, and therefore our arrangement with the user **is not exclusive.**

TI assumes **no liability for applications assistance, customer product design, software performance, or infringement of patents or services described herein.**

Please read the User's Guide and, specifically, the Warnings and Restrictions notice in the User's Guide prior to handling the product. This notice contains important safety information about temperatures and voltages. For additional information on TI's environmental and/or safety programs, please contact the TI application engineer or visit www.ti.com/esh.

No license is granted under any patent right or other intellectual property right of TI covering or relating to any machine, process, or combination in which such TI products or services might be or are used.

FCC Warning

This evaluation board/kit is intended for use for **ENGINEERING DEVELOPMENT, DEMONSTRATION, OR EVALUATION PURPOSES ONLY** and is not considered by TI to be a finished end-product fit for general consumer use. It generates, uses, and can radiate radio frequency energy and has not been tested for compliance with the limits of computing devices pursuant to part 15 of FCC rules, which are designed to provide reasonable protection against radio frequency interference. Operation of this equipment in other environments may cause interference with radio communications, in which case the user at his own expense will be required to take whatever measures may be required to correct this interference.

EVM Warnings and Restrictions

It is important to operate this EVM within the input voltage range of -3 V to 6 V and the output voltage range of -3 V to 6 V .

Exceeding the specified input range may cause unexpected operation and/or irreversible damage to the EVM. If there are questions concerning the input range, please contact a TI field representative prior to connecting the input power.

Applying loads outside of the specified output range may result in unintended operation and/or possible permanent damage to the EVM. Please consult the EVM User's Guide prior to connecting any load to the EVM output. If there is uncertainty as to the load specification, please contact a TI field representative.

During normal operation, some circuit components may have case temperatures greater than 25° C. The EVM is designed to operate properly with certain components above 50° C as long as the input and output ranges are maintained. These components include but are not limited to linear regulators, switching transistors, pass transistors, and current sense resistors. These types of devices can be identified using the EVM schematic located in the EVM User's Guide. When placing measurement probes near these devices during operation, please be aware that these devices may be very warm to the touch.

Mailing Address: Texas Instruments, Post Office Box 655303, Dallas, Texas 75265
Copyright © 2011, Texas Instruments Incorporated

IMPORTANT NOTICE

Texas Instruments Incorporated and its subsidiaries (TI) reserve the right to make corrections, modifications, enhancements, improvements, and other changes to its products and services at any time and to discontinue any product or service without notice. Customers should obtain the latest relevant information before placing orders and should verify that such information is current and complete. All products are sold subject to TI's terms and conditions of sale supplied at the time of order acknowledgment.

TI warrants performance of its hardware products to the specifications applicable at the time of sale in accordance with TI's standard warranty. Testing and other quality control techniques are used to the extent TI deems necessary to support this warranty. Except where mandated by government requirements, testing of all parameters of each product is not necessarily performed.

TI assumes no liability for applications assistance or customer product design. Customers are responsible for their products and applications using TI components. To minimize the risks associated with customer products and applications, customers should provide adequate design and operating safeguards.

TI does not warrant or represent that any license, either express or implied, is granted under any TI patent right, copyright, mask work right, or other TI intellectual property right relating to any combination, machine, or process in which TI products or services are used. Information published by TI regarding third-party products or services does not constitute a license from TI to use such products or services or a warranty or endorsement thereof. Use of such information may require a license from a third party under the patents or other intellectual property of the third party, or a license from TI under the patents or other intellectual property of TI.

Reproduction of TI information in TI data books or data sheets is permissible only if reproduction is without alteration and is accompanied by all associated warranties, conditions, limitations, and notices. Reproduction of this information with alteration is an unfair and deceptive business practice. TI is not responsible or liable for such altered documentation. Information of third parties may be subject to additional restrictions.

Resale of TI products or services with statements different from or beyond the parameters stated by TI for that product or service voids all express and any implied warranties for the associated TI product or service and is an unfair and deceptive business practice. TI is not responsible or liable for any such statements.

TI products are not authorized for use in safety-critical applications (such as life support) where a failure of the TI product would reasonably be expected to cause severe personal injury or death, unless officers of the parties have executed an agreement specifically governing such use. Buyers represent that they have all necessary expertise in the safety and regulatory ramifications of their applications, and acknowledge and agree that they are solely responsible for all legal, regulatory and safety-related requirements concerning their products and any use of TI products in such safety-critical applications, notwithstanding any applications-related information or support that may be provided by TI. Further, Buyers must fully indemnify TI and its representatives against any damages arising out of the use of TI products in such safety-critical applications.

TI products are neither designed nor intended for use in military/aerospace applications or environments unless the TI products are specifically designated by TI as military-grade or "enhanced plastic." Only products designated by TI as military-grade meet military specifications. Buyers acknowledge and agree that any such use of TI products which TI has not designated as military-grade is solely at the Buyer's risk, and that they are solely responsible for compliance with all legal and regulatory requirements in connection with such use.

TI products are neither designed nor intended for use in automotive applications or environments unless the specific TI products are designated by TI as compliant with ISO/TS 16949 requirements. Buyers acknowledge and agree that, if they use any non-designated products in automotive applications, TI will not be responsible for any failure to meet such requirements.

Following are URLs where you can obtain information on other Texas Instruments products and application solutions:

Products

Audio	www.ti.com/audio
Amplifiers	amplifier.ti.com
Data Converters	dataconverter.ti.com
DLP® Products	www.dlp.com
DSP	dsp.ti.com
Clocks and Timers	www.ti.com/clocks
Interface	interface.ti.com
Logic	logic.ti.com
Power Mgmt	power.ti.com
Microcontrollers	microcontroller.ti.com
RFID	www.ti-rfid.com
OMAP Mobile Processors	www.ti.com/omap
Wireless Connectivity	www.ti.com/wirelessconnectivity

Applications

Communications and Telecom	www.ti.com/communications
Computers and Peripherals	www.ti.com/computers
Consumer Electronics	www.ti.com/consumer-apps
Energy and Lighting	www.ti.com/energy
Industrial	www.ti.com/industrial
Medical	www.ti.com/medical
Security	www.ti.com/security
Space, Avionics and Defense	www.ti.com/space-avionics-defense
Transportation and Automotive	www.ti.com/automotive
Video and Imaging	www.ti.com/video

TI E2E Community Home Page

e2e.ti.com

Mailing Address: Texas Instruments, Post Office Box 655303, Dallas, Texas 75265
Copyright © 2011, Texas Instruments Incorporated