

AMC1300 Precision, ± 250 -mV Input, Reinforced Isolated Amplifier

1 Features

- ± 250 -mV input voltage range optimized for current measurement using shunt resistors
- Fixed gain: 8.2
- Low DC errors:
 - AMC1300B:
 - Offset error: ± 0.2 mV (maximum)
 - Offset drift: ± 0.9 $\mu\text{V}/^\circ\text{C}$ (maximum)
 - Gain error: $\pm 0.3\%$ (maximum)
 - Gain drift: ± 30 ppm/ $^\circ\text{C}$ (maximum)
 - AMC1300:
 - Offset error: ± 2 mV (maximum)
 - Offset drift: ± 4 $\mu\text{V}/^\circ\text{C}$ (maximum)
 - Gain error: $\pm 1\%$ (maximum)
 - Gain drift: ± 50 ppm/ $^\circ\text{C}$ (typical)
 - Nonlinearity: 0.03% (maximum)
- 3.3-V operation on high-side (AMC1300B)
- High CMTI: 100 kV/ μs (minimum) (AMC1300B)
- Low EMI, meets CISPR-11 and CISPR-25 standards
- System-level diagnostic features
- Safety-related certifications:
 - 7071- V_{PK} reinforced isolation per DIN VDE V 0884-11: 2017-01
 - 5000- V_{RMS} isolation for 1 minute per UL1577

2 Applications

- Shunt-resistor-based current sensing in:
 - [Motor drives](#)
 - [Frequency inverters](#)
 - [Uninterruptible power supplies](#)

3 Description

The AMC1300 is a precision, isolated amplifier with an output separated from the input circuitry by an isolation barrier that is highly resistant to magnetic interference. This barrier is certified to provide reinforced galvanic isolation of up to 5 kV_{RMS} according to VDE V 0884-11 and UL1577. Used in conjunction with isolated power supplies, this isolated amplifier separates parts of the system that operate on different common-mode voltage levels and protects lower-voltage parts from damage.

The input of the AMC1300 is optimized for direct connection to shunt resistors or other low voltage-level signal sources. The excellent performance of the device supports accurate current control resulting in system-level power savings and, especially in motor control applications, lower torque ripple. The integrated common-mode overvoltage and missing high-side supply voltage detection features of the AMC1300 simplify system-level design and diagnostics.

The AMC1300 is offered with two performance grade options: the AMC1300B is specified over the extended industrial temperature range of -55°C to $+125^\circ\text{C}$, and the AMC1300 for operation at -40°C to $+125^\circ\text{C}$.

Device Information⁽¹⁾

PART NUMBER	PACKAGE	BODY SIZE (NOM)
AMC1300	SOIC (8)	5.85 mm × 7.50 mm

- (1) For all available packages, see the orderable addendum at the end of the data sheet.

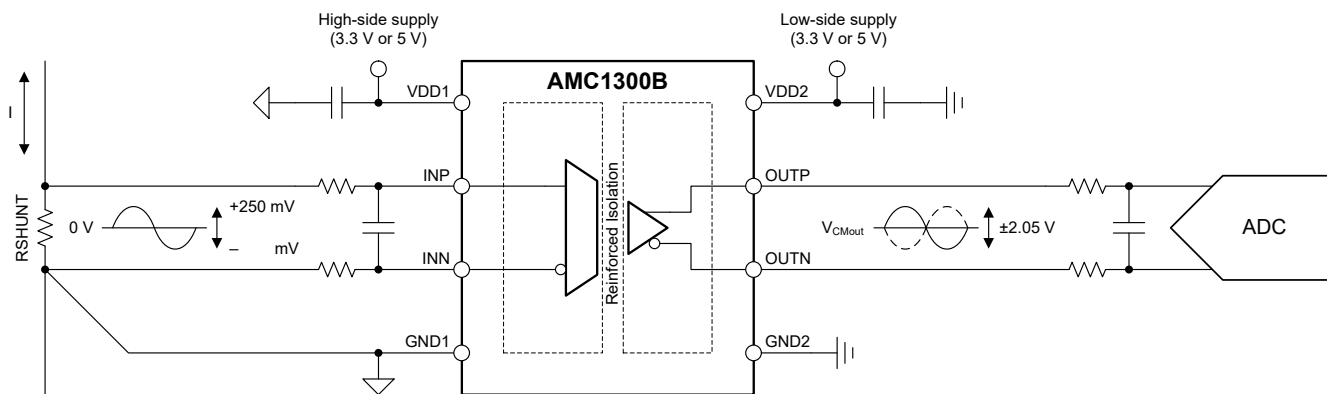

Simplified Schematic



Table of Contents

1 Features	1	8.1 Overview.....	20
2 Applications	1	8.2 Functional Block Diagram.....	20
3 Description	1	8.3 Feature Description.....	20
4 Revision History	2	8.4 Device Functional Modes.....	22
5 Device Comparison Table	3	9 Application and Implementation	23
6 Pin Configuration and Functions	4	9.1 Application Information.....	23
7 Specifications	5	9.2 Typical Application.....	23
7.1 Absolute Maximum Ratings	5	9.3 What To Do and What Not To Do.....	26
7.2 ESD Ratings	5	10 Power Supply Recommendations	27
7.3 Recommended Operating Conditions	5	11 Layout	28
7.4 Thermal Information	6	11.1 Layout Guidelines.....	28
7.5 Power Ratings	6	11.2 Layout Example.....	28
7.6 Insulation Specifications	7	12 Device and Documentation Support	29
7.7 Safety-Related Certifications	8	12.1 Documentation Support.....	29
7.8 Safety Limiting Values	8	12.2 Receiving Notification of Documentation Updates.....	29
7.9 Electrical Characteristics	9	12.3 Support Resources.....	29
7.10 Switching Characteristics	11	12.4 Trademarks.....	29
7.11 Timing Diagram.....	11	12.5 Electrostatic Discharge Caution.....	29
7.12 Insulation Characteristics Curves.....	12	12.6 Glossary.....	29
7.13 Typical Characteristics.....	13	13 Mechanical, Packaging, and Orderable Information	29
8 Detailed Description	20		

4 Revision History

NOTE: Page numbers for previous revisions may differ from page numbers in the current version.

Changes from Revision C (June 2021) to Revision D (May 2022)	Page
• Changed CDM ESD standard from JESD22-C101 to ANSI/ESDA/JEDEC JS-002	5
• Changed T_A (max) for AMC1300 from 105 °C to 125 °C.	5
• Updated VDE standard references is <i>Safety-Related Certifications</i> table.....	8

Changes from Revision B (April 2020) to Revision C (June 2021)	Page
• Changed <i>Features</i> section.....	1
• Changed several figures throughout document (editorial changes only).....	1
• Changed TCV_{OS} , TCE_G , and CMTI values in AMC1300B column of <i>Device Comparison Table</i>	3
• Changed C_{IO} from ~1 pF to ~1.5 pF.....	7
• Changed V_{CMov} hysteresis from 95 mV to 60 mV.....	9
• Changed TCV_{OS} (AMC1300B) from ± 3 to ± 0.9 $\mu V/^\circ C$ and typical value from ± 1 to ± 0.1 $\mu V/^\circ C$	9
• Changed TCE_G (AMC1300B) from ± 50 to ± 30 ppm/ $^\circ C$ and typical value from ± 15 to ± 5 ppm/ $^\circ C$	9
• Changed SNR (min), $f_{IN} = 1$ kHz from 80 dB to 81.5 dB.....	9
• Added $V_{CLIPout}$ specification.....	9
• Changed $V_{FAILSAFE}$ from * / -2.6 V / -2.5 V to -2.63 V / -2.57 V / -2.53 V (min / typ / max).....	9
• Changed output short-circuit current from ± 13 mA to 14 mA (sourcing or sinking).....	9
• Changed CMTI (AMC1300B) min from 75 to 100 kV/ μs and typ from 140 to 150 kV/ μs	9
• Changed $VDD1_{UV}$ from 1.75 V / 2.53 V / 2.7 V to 2.4 V / 2.6 V / 2.8 V (min / typ / max).....	9
• Changed <i>Analog Input</i> section.....	20
• Changed <i>Analog Output</i> section.....	22
• Changed <i>Detailed Design Procedure</i> section.....	24
• Added <i>Shunt Resistor Sizing</i> section.....	24
• Added <i>Input Filter Design</i> section.....	24
• Added <i>Differential to Single-Ended Output Conversion</i> section.....	25
• Changed <i>Application Curves</i> section.....	26
• Added layout recommendations to <i>What To Do and What Not To Do</i> section.....	26

5 Device Comparison Table

PARAMETER		AMC1300B	AMC1300
High-side supply voltage, VDD1		3.0 V to 5.5 V	4.5 V to 5.5 V
Specified ambient temperature, T _A		–55°C to +125°C	–40°C to +125°C
Input offset voltage, V _{OS}	4.5 V ≤ VDD1 ≤ 5.5 V	±0.2 mV	±2 mV
	3.0 V ≤ VDD1 ≤ 4.5 V		Not applicable
Input offset drift, TC _{VOS}		±0.9 μV/°C (max)	±4 μV/°C (max)
Gain error, E _G		±0.3%	±1%
Gain error drift, TCE _G		±5 ppm/°C (typ), ±30 ppm/°C (max)	±50 ppm/°C (typ)
Common-mode transient immunity, CMTI		100 kV/μs (min), 150 kV/μs (typ)	15 kV/μs (min), 30 kV/μs (typ)
Output bandwidth, BW		250 kHz (min), 310 kHz (typ)	170 kHz (min), 230 kHz (typ)
INP, INN to OUTP, OUTN signal delay (50% – 90%)		3 μs (max)	3.4 μs (max)

6 Pin Configuration and Functions

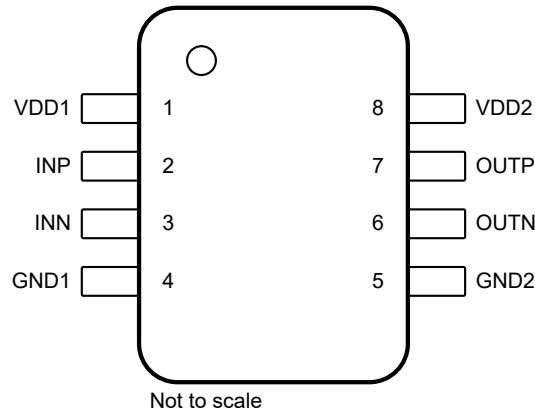

Figure 6-1. DWV Package, 8-Pin SOIC, Top View

Table 6-1. Pin Functions

PIN		TYPE	DESCRIPTION
NO.	NAME		
1	VDD1	High-side power	High-side power supply. ⁽¹⁾
2	INP	Analog input	Noninverting analog input. Either INP or INN must have a DC current path to GND1 to define the common-mode input voltage. ⁽²⁾
3	INN	Analog input	Inverting analog input. Either INP or INN must have a DC current path to GND1 to define the common-mode input voltage. ⁽²⁾
4	GND1	High-side ground	High-side analog ground.
5	GND2	Low-side ground	Low-side analog ground.
6	OUTN	Analog output	Inverting analog output.
7	OUTP	Analog output	Noninverting analog output.
8	VDD2	Low-side power	Low-side power supply. ⁽¹⁾

(1) See the [Power Supply Recommendations](#) section for power-supply decoupling recommendations.

(2) See the [Layout](#) section for details.

7 Specifications

7.1 Absolute Maximum Ratings

over operating ambient temperature range (unless otherwise noted)⁽¹⁾

		MIN	MAX	UNIT
Power-supply voltage	High-side VDD1 to GND1	-0.3	6.5	V
	Low-side VDD2 to GND2	-0.3	6.5	
Analog input voltage	INP, INN	GND1 – 6	VDD1 + 0.5	V
Output voltage	OUTP, OUTN	GND2 – 0.5	VDD2 + 0.5	V
Input current	Continuous, any pin except power-supply pins	-10	10	mA
Temperature	Junction, T _J		150	°C
	Storage, T _{stg}	-65	150	°C

- (1) Operation outside the *Absolute Maximum Ratings* may cause permanent device damage. Absolute Maximum Ratings do not imply functional operation of the device at these or any other conditions beyond those listed under *Recommended Operating Conditions*. If used outside the Recommended Operating Conditions but within the Absolute Maximum Ratings, the device may not be fully functional, and this may affect device reliability, functionality, performance, and shorten the device lifetime

7.2 ESD Ratings

			VALUE	UNIT
V _(ESD)	Electrostatic discharge	Human body model (HBM), per ANSI/ESDA/JEDEC JS-001 ⁽¹⁾	±2000	V
		Charged device model (CDM), per ANSI/ESDA/JEDEC JS-002 ⁽²⁾	±1000	

- (1) JEDEC document JEP155 states that 500-V HBM allows safe manufacturing with a standard ESD control process.
 (2) JEDEC document JEP157 states that 250-V CDM allows safe manufacturing with a standard ESD control process.

7.3 Recommended Operating Conditions

over operating ambient temperature range (unless otherwise noted)

			MIN	NOM	MAX	UNIT
POWER SUPPLY						
	High-side power supply	VDD1 to GND1, AMC1300	4.5	5	5.5	V
		VDD1 to GND1, AMC1300B	3	5	5.5	
	Low-side power supply	VDD2 to GND2	3	3.3	5.5	V
ANALOG INPUT						
V _{Clipping}	Differential input voltage before clipping output	V _{IN} = V _{INP} - V _{INN}	±320			mV
V _{FSR}	Specified linear differential full-scale voltage	V _{IN} = V _{INP} - V _{INN}	-250		250	mV
	Absolute common-mode input voltage ⁽¹⁾	(V _{INP} +V _{INN}) / 2 to GND1	-2		VDD1	V
V _{CM}	Operating common-mode input voltage	(V _{INP} +V _{INN}) / 2 to GND1	-0.16		VDD1 – 2.1	V
TEMPERATURE RANGE						
T _A	Specified ambient temperature	AMC1300	-40		125	°C
		AMC1300B	-55		125	°C

- (1) Steady-state voltage supported by the device in case of a system failure. See specified common-mode input voltage V_{CM} for normal operation. Observe analog input voltage range as specified in Absolute Maximum Ratings.

7.4 Thermal Information

THERMAL METRIC ⁽¹⁾		AMC1300x	UNIT
		DWV (SOIC)	
		8 PINS	
R _{θJA}	Junction-to-ambient thermal resistance	85.4	°C/W
R _{θJC(top)}	Junction-to-case (top) thermal resistance	26.8	°C/W
R _{θJB}	Junction-to-board thermal resistance	43.5	°C/W
Ψ _{JT}	Junction-to-top characterization parameter	4.8	°C/W
Ψ _{JB}	Junction-to-board characterization parameter	41.2	°C/W
R _{θJC(bot)}	Junction-to-case (bottom) thermal resistance	N/A	°C/W

(1) For more information about traditional and new thermal metrics, see the [Semiconductor and IC Package Thermal Metrics](#) application report.

7.5 Power Ratings

PARAMETER		TEST CONDITIONS	VALUE	UNIT
P _D	Maximum power dissipation (both sides)	VDD1 = VDD2 = 5.5 V	99	mW
		VDD1 = VDD2 = 3.6 V, AMC1300B only	57	
P _{D1}	Maximum power dissipation (high-side)	VDD1 = 5.5 V	54	mW
		VDD1 = 3.6 V, AMC1300B only	31	
P _{D2}	Maximum power dissipation (low-side)	VDD2 = 5.5 V	45	mW
		VDD2 = 3.6 V	26	

7.6 Insulation Specifications

over operating ambient temperature range (unless otherwise noted)

PARAMETER		TEST CONDITIONS	VALUE	UNIT
GENERAL				
CLR	External clearance ⁽¹⁾	Shortest terminal-to-terminal distance through air	≥ 8.5	mm
CPG	External Creepage ⁽¹⁾	Shortest terminal-to-terminal distance across the package surface	≥ 8.5	mm
DTI	Distance through the insulation	Minimum internal gap (internal clearance) of the double isolation (2 × 0.0105 mm)	≥ 0.021	mm
CTI	Comparative tracking index	DIN EN 60112 (VDE 0303-11); IEC 60112	≥ 600	V
	Material Group	According to IEC 60664-1	I	
	Overvoltage category	Rated mains voltage ≤ 600 V _{RMS}	I-IV	
		Rated mains voltage ≤ 1000 V _{RMS}	I-III	
DIN VDE 0884-11 (VDE V 0884-11): 2017-01				
V _{IORM}	Maximum repetitive peak isolation voltage	AC voltage (bipolar)	2121	V _{PK}
V _{IOWM}	Maximum isolation working voltage	AC voltage (sine wave); time-dependent dielectric breakdown (TDDb) test; see Figure 4	1500	V _{RMS}
		DC voltage	2121	V _{DC}
V _{IOTM}	Maximum transient isolation voltage	V _{TEST} = V _{IOTM} , t = 60 s (qualification test)	7071	V _{PK}
		V _{TEST} = V _{IOTM} , t = 1 s (100% production test)	8485	V _{PK}
V _{IOSM}	Maximum surge isolation voltage ⁽²⁾	Test method per IEC 60065, 1.2/50 μs waveform, V _{TEST} = 1.6 × V _{IOSM} = 12800 V _{PK} (qualification)	8000	V _{PK}
q _{pd}	Apparent charge ⁽³⁾	Method a: After I/O safety test subgroup 2/3, V _{ini} = V _{IOTM} , t _{ini} = 60 s; V _{pd(m)} = 1.2 × V _{IORM} = 2545 V _{PK} , t _m = 10 s	≤ 5	pC
		Method a: After environmental tests subgroup 1, V _{ini} = V _{IOTM} , t _{ini} = 60 s; V _{pd(m)} = 1.6 × V _{IORM} = 3394 V _{PK} , t _m = 10 s	≤ 5	
		Method b1: At routine test (100% production) and preconditioning (type test), V _{ini} = V _{IOTM} , t _{ini} = 1 s; V _{pd(m)} = 1.875 × V _{IORM} = 3977 V _{PK} , t _m = 1 s	≤ 5	
C _{IO}	Barrier capacitance, input to output ⁽⁴⁾	V _{IO} = 0.4 × sin (2 πft), f = 1 MHz	~1.5	pF
R _{IO}	Insulation resistance, input to output ⁽⁴⁾	V _{IO} = 500 V, T _A = 25°C	> 10 ¹²	Ω
		V _{IO} = 500 V, 100°C ≤ T _A ≤ 125°C	> 10 ¹¹	
		V _{IO} = 500 V at T _S = 150°C	> 10 ⁹	
	Pollution degree		2	
	Climatic category		55/125/21	
UL 1577				
V _{ISO}	Withstand isolation voltage	V _{TEST} = V _{ISO} = 5000 V _{RMS} , t = 60 s (qualification), V _{TEST} = 1.2 × V _{ISO} = 6000 V _{RMS} , t = 1 s (100% production)	5000	V _{RMS}

- (1) Creepage and clearance requirements should be applied according to the specific equipment isolation standards of an application. Care should be taken to maintain the creepage and clearance distance of a board design to ensure that the mounting pads of the isolator on the printed-circuit board do not reduce this distance. Creepage and clearance on a printed-circuit board become equal in certain cases. Techniques such as inserting grooves, ribs, or both on a printed-circuit board are used to help increase these specifications.
- (2) Testing is carried out in air or oil to determine the intrinsic surge immunity of the isolation barrier.
- (3) Apparent charge is electrical discharge caused by a partial discharge (pd).
- (4) All pins on each side of the barrier tied together creating a two-pin device.

7.7 Safety-Related Certifications

VDE	UL
Certified according to DIN VDE V 0884-11 (VDE V 0884-11): 2017-01, DIN EN 62368-1: 2016-05, EN 62368-1: 2014, and IEC 62368-1: 2014	Recognized under 1577 component recognition and CSA component acceptance NO 5 programs
Reinforced insulation	Single protection
Certificate number: 40040142	Certificate number: E181974

7.8 Safety Limiting Values

Safety limiting⁽¹⁾ intends to minimize potential damage to the isolation barrier upon failure of input or output circuitry. A failure of the I/O can allow low resistance to ground or the supply and, without current limiting, dissipate sufficient power to over-heat the die and damage the isolation barrier potentially leading to secondary system failures.

PARAMETER		TEST CONDITIONS	MIN	TYP	MAX	UNIT
I_S	Safety input, output, or supply current	$R_{\theta JA} = 85.4^\circ\text{C/W}$, $V_{DDX} = 5.5\text{ V}$, $T_J = 150^\circ\text{C}$, $T_A = 25^\circ\text{C}$			266	mA
I_S	Safety input, output, or supply current	$R_{\theta JA} = 85.4^\circ\text{C/W}$, $V_{DDX} = 3.6\text{ V}$, $T_J = 150^\circ\text{C}$, $T_A = 25^\circ\text{C}$			407	mA
P_S	Safety input, output, or total power	$R_{\theta JA} = 85.4^\circ\text{C/W}$, $T_J = 150^\circ\text{C}$, $T_A = 25^\circ\text{C}$			1464	mW
T_S	Maximum safety temperature				150	$^\circ\text{C}$

- (1) The maximum safety temperature, T_S , has the same value as the maximum junction temperature, T_J , specified for the device. The I_S and P_S parameters represent the safety current and safety power, respectively. Do not exceed the maximum limits of I_S and P_S . These limits vary with the ambient temperature, T_A .

The junction-to-air thermal resistance, $R_{\theta JA}$, in the Thermal Information table is that of a device installed on a high-K test board for leaded surface-mount packages. Use these equations to calculate the value for each parameter:

$T_J = T_A + R_{\theta JA} \times P$, where P is the power dissipated in the device.

$T_{J(\max)} = T_S = T_A + R_{\theta JA} \times P_S$, where $T_{J(\max)}$ is the maximum junction temperature.

$P_S = I_S \times V_{DD\max}$, where $V_{DD\max}$ is the maximum supply voltage for high-side and low-side.

7.9 Electrical Characteristics

minimum and maximum specifications of the AMC1300 apply from $T_A = -40^\circ\text{C}$ to $+105^\circ\text{C}$, $V_{DD1} = 4.5\text{ V}$ to 5.5 V , $V_{DD2} = 3.0\text{ V}$ to 5.5 V , $I_{NP} = -250\text{ mV}$ to $+250\text{ mV}$, and $I_{NN} = \text{GND1}$; minimum and maximum specifications of the AMC1300B apply from $T_A = -55^\circ\text{C}$ to $+125^\circ\text{C}$, $V_{DD1} = 3.0\text{ V}$ to 5.5 V , $V_{DD2} = 3.0\text{ V}$ to 5.5 V , $I_{NP} = -250\text{ mV}$ to $+250\text{ mV}$, and $I_{NN} = \text{GND1}$; typical specifications are at $T_A = 25^\circ\text{C}$, $V_{DD1} = 5\text{ V}$, and $V_{DD2} = 3.3\text{ V}$ (unless otherwise noted)

PARAMETER		TEST CONDITIONS	MIN	TYP	MAX	UNIT
ANALOG INPUT						
V_{CMov}	Common-mode overvoltage detection level	$(V_{INP} + V_{INN}) / 2$ to GND1	$V_{DD1} - 2$			V
	Hysteresis of common-mode overvoltage detection level		60			mV
V_{OS}	Input offset voltage ^{(1) (2)}	AMC1300, initial, at $T_A = 25^\circ\text{C}$, $V_{INP} = V_{INN} = \text{GND1}$	-2	± 0.01	2	mV
		AMC1300B, initial, at $T_A = 25^\circ\text{C}$, $V_{INP} = V_{INN} = \text{GND1}$, $4.5\text{ V} \leq V_{DD1} \leq 5.5\text{ V}$	-0.2	± 0.01	0.2	
		AMC1300B, initial, at $T_A = 25^\circ\text{C}$, $V_{INP} = V_{INN} = \text{GND1}$, $3.0\text{ V} \leq V_{DD1} \leq 5.5\text{ V}$	-0.2	± 0.01	0.2	
TCV_{OS}	Input offset drift ^{(1) (2) (4)}	AMC1300	-4	± 1.3	4	$\mu\text{V}/^\circ\text{C}$
		AMC1300B	-0.9	± 0.1	0.9	
CMRR	Common-mode rejection ratio	$f_{IN} = 0\text{ Hz}$, $V_{CM\ min} \leq V_{CM} \leq V_{CM\ max}$	-100			dB
		$f_{IN} = 10\text{ kHz}$, $V_{CM\ min} \leq V_{CM} \leq V_{CM\ max}$	-98			
R_{IN}	Single-ended input resistance	$I_{NN} = \text{GND1}$	19			k Ω
R_{IND}	Differential input resistance		22			
I_{IB}	Input bias current	$I_{NP} = I_{NN} = \text{GND1}$; $I_{IB} = (I_{IBP} + I_{IBN}) / 2$	-41	-30	-24	μA
I_{IO}	Input offset current	$I_{IO} = I_{IBP} - I_{IBN}$	± 5			nA
C_{IN}	Single-ended input capacitance	$I_{NN} = \text{GND1}$, $f_{IN} = 275\text{ kHz}$	2			pF
C_{IND}	Differential input capacitance	$f_{IN} = 275\text{ kHz}$	1			
ANALOG OUTPUT						
	Nominal gain		8.2			
E_G	Gain error ⁽¹⁾	AMC1300, initial, at $T_A = 25^\circ\text{C}$	-1%	0.4%	1%	
		AMC1300B, initial, at $T_A = 25^\circ\text{C}$	-0.3%	$\pm 0.05\%$	0.3%	
TCE_G	Gain error drift ^{(1) (5)}	AMC1300	± 50			ppm/ $^\circ\text{C}$
		AMC1300B	-30	± 5	30	
	Nonlinearity ⁽¹⁾		-0.03	± 0.01	0.03	%
THD	Total harmonic distortion ⁽³⁾	$f_{IN} = 10\text{ kHz}$	-85			dB
	Output noise	$I_{NP} = I_{NN} = \text{GND1}$, $f_{IN} = 0\text{ Hz}$, BW = 100 kHz brickwall filter	230			μV_{RMS}
SNR	Signal-to-noise ratio	$f_{IN} = 1\text{ kHz}$, BW = 10 kHz	81.5	85		dB
		$f_{IN} = 10\text{ kHz}$, BW = 100 kHz	72			
PSRR	Power-supply rejection ratio ⁽²⁾	PSRR vs V_{DD1} , at DC	-103			dB
		PSRR vs V_{DD1} , 100-mV and 10-kHz ripple	-96			
		PSRR vs V_{DD2} , at DC	-106			
		PSRR vs V_{DD2} , 100-mV and 10-kHz ripple	-86			
V_{CMout}	Common-mode output voltage		1.39	1.44	1.49	V
$V_{CLIPout}$	Clipping differential output voltage	$V_{OUT} = (V_{OUTP} - V_{OUTN})$; $ V_{IN} = V_{INP} - V_{INN} > V_{Clipping} $	-2.52	± 2.49	2.52	V
$V_{FAILSAFE}$	Failsafe differential output voltage	$V_{CM} \geq V_{CMov}$, or V_{DD1} missing	-2.63	-2.57	-2.53	V

7.9 Electrical Characteristics (continued)

minimum and maximum specifications of the AMC1300 apply from $T_A = -40^\circ\text{C}$ to $+105^\circ\text{C}$, $V_{DD1} = 4.5\text{ V}$ to 5.5 V , $V_{DD2} = 3.0\text{ V}$ to 5.5 V , $\text{INP} = -250\text{ mV}$ to $+250\text{ mV}$, and $\text{INN} = \text{GND1}$; minimum and maximum specifications of the AMC1300B apply from $T_A = -55^\circ\text{C}$ to $+125^\circ\text{C}$, $V_{DD1} = 3.0\text{ V}$ to 5.5 V , $V_{DD2} = 3.0\text{ V}$ to 5.5 V , $\text{INP} = -250\text{ mV}$ to $+250\text{ mV}$, and $\text{INN} = \text{GND1}$; typical specifications are at $T_A = 25^\circ\text{C}$, $V_{DD1} = 5\text{ V}$, and $V_{DD2} = 3.3\text{ V}$ (unless otherwise noted)

PARAMETER		TEST CONDITIONS	MIN	TYP	MAX	UNIT
BW _{OUT}	Output bandwidth	AMC1300	170	230		kHz
		AMC1300B	250	310		
R _{OUT}	Output resistance	On O _{UTP} or O _{UTN}		< 0.2		Ω
	Output short-circuit current	On O _{UTP} or O _{UTN} , sourcing or sinking, $\text{INN} = \text{INP} = \text{GND1}$, outputs shorted to either GND2 or VDD2		14		mA
CMTI	Common-mode transient immunity	$ \text{GND1} - \text{GND2} = 1\text{ kV}$, AMC1300	15	30		kV/μs
		$ \text{GND1} - \text{GND2} = 1\text{ kV}$, AMC1300B	100	150		
POWER SUPPLY						
VDD1 _{UV}	VDD1 undervoltage detection threshold voltage	VDD1 falling	2.4	2.6	2.8	V
IDD1	High-side supply current	AMC1300B only, $3.0\text{ V} \leq V_{DD1} \leq 3.6\text{ V}$		6.3	8.5	mA
		$4.5\text{ V} \leq V_{DD1} \leq 5.5\text{ V}$		7.2	9.8	
IDD2	Low-side supply current	$3.0\text{ V} \leq V_{DD2} \leq 3.6\text{ V}$		5.3	7.2	mA
		$4.5\text{ V} \leq V_{DD2} \leq 5.5\text{ V}$		5.9	8.1	

- (1) The typical value includes one standard deviation ("sigma") at nominal operating conditions.
- (2) This parameter is input referred.
- (3) THD is the ratio of the rms sum of the amplitudes of first five higher harmonics to the amplitude of the fundamental.
- (4) Offset error temperature drift is calculated using the box method, as described by the following equation:

$$TCV_{OS} = (Value_{MAX} - Value_{MIN}) / TempRange$$
- (5) Gain error temperature drift is calculated using the box method, as described by the following equation:

$$TCE_G (ppm) = (Value_{MAX} - Value_{MIN}) / (Value_{(T=25^\circ\text{C})} \times TempRange) \times 10^6$$

7.10 Switching Characteristics

over operating free-air temperature range (unless otherwise noted)

PARAMETER		TEST CONDITIONS	MIN	TYP	MAX	UNIT
t_r	Output signal rise time			1.3		μs
t_f	Output signal fall time			1.3		μs
	V_{INx} to V_{OUTx} signal delay (50% - 10%)	AMC1300, unfiltered output		1.5	2.2	μs
		AMC1300B, unfiltered output		1	1.5	
	V_{INx} to V_{OUTx} signal delay (50% - 50%)	AMC1300, unfiltered output		2	2.7	μs
		AMC1300B, unfiltered output		1.6	2.1	
	V_{INx} to V_{OUTx} signal delay (50% - 90%)	AMC1300, unfiltered output		2.7	3.4	μs
		AMC1300B, unfiltered output		2.5	3	
t_{AS}	Analog settling time	VDD1 step to 3.0 V with VDD2 \geq 3.0 V, to V_{OUTP} , V_{OUTN} valid, 0.1% settling		500		μs

7.11 Timing Diagram

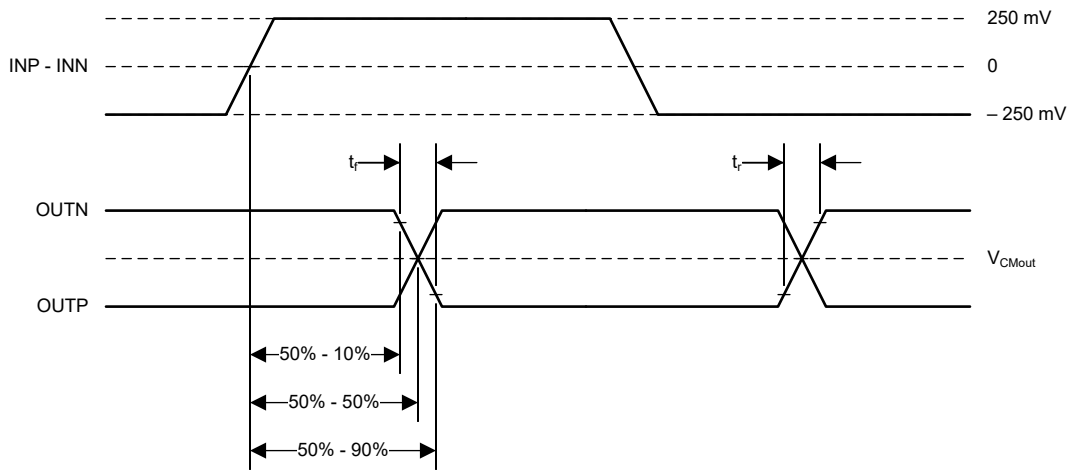

Figure 7-1. Rise, Fall, and Delay Time Waveforms

7.12 Insulation Characteristics Curves

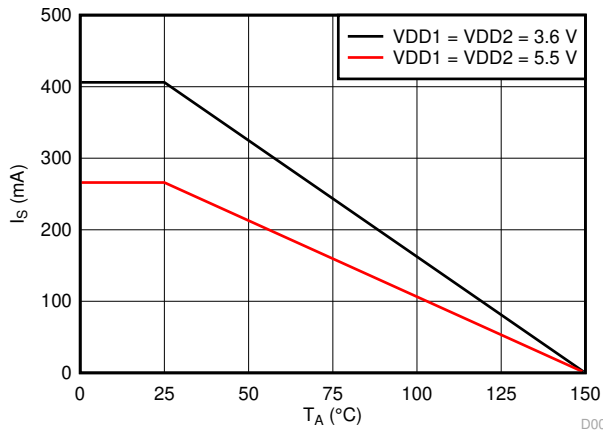

Figure 7-2. Thermal Derating Curve for Safety-Limiting Current per VDE

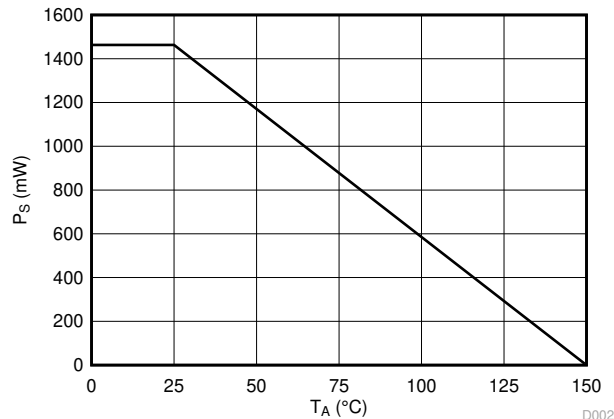
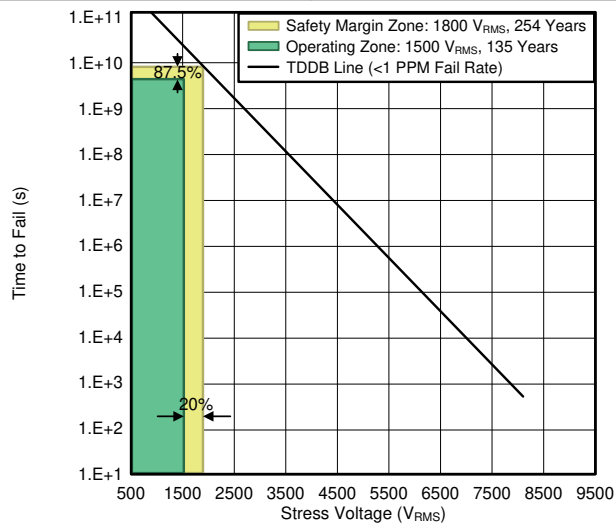

Figure 7-3. Thermal Derating Curve for Safety-Limiting Power per VDE



T_A up to 150°C, stress-voltage frequency = 60 Hz, isolation working voltage = 1500 V_{RMS} , operating lifetime = 135 year

Figure 7-4. Reinforced Isolation Capacitor Lifetime Projection

7.13 Typical Characteristics

at VDD1 = 5 V, VDD2 = 3.3 V, VINP = -250 mV to 250 mV, VINN = 0 V, and f_{IN} = 10 kHz (unless otherwise noted)

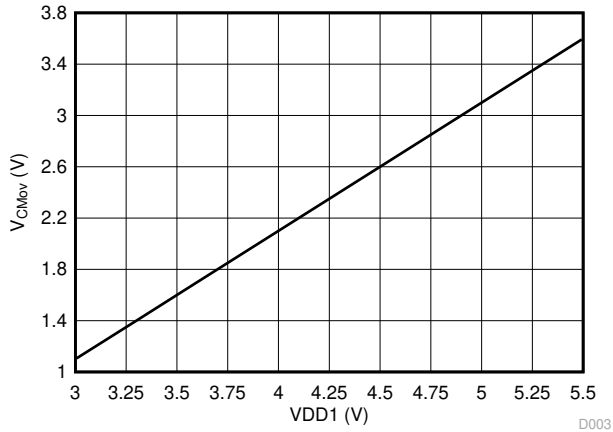

Figure 7-5. Common-Mode Overvoltage Detection Level vs High-Side Supply Voltage

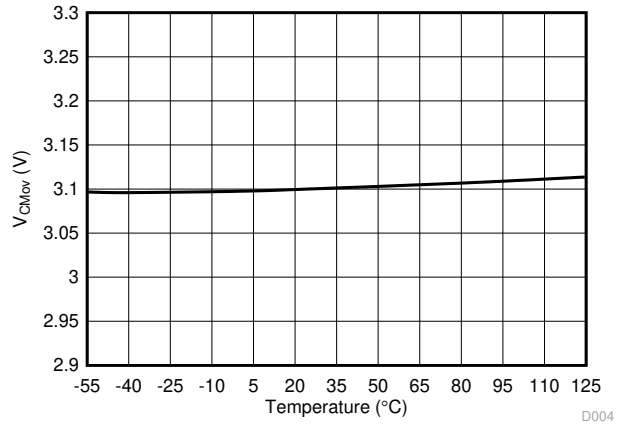
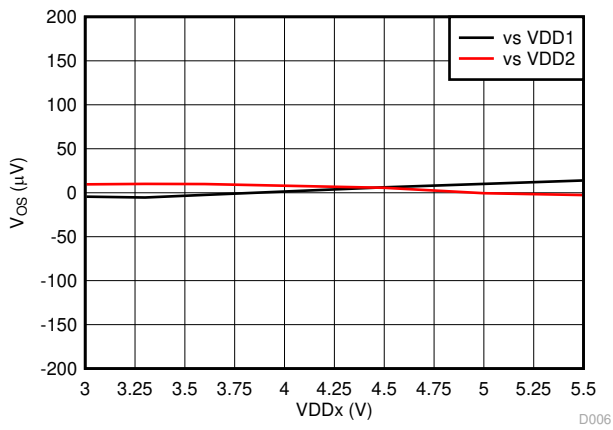
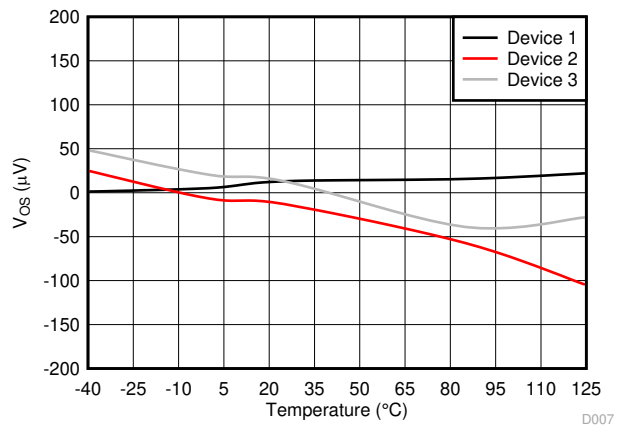

Figure 7-6. Common-Mode Overvoltage Detection Level vs Temperature



3 V ≤ VDD1 < 4.5 V for AMC1300B only

Figure 7-7. Input Offset Voltage vs Supply Voltage



AMC1300

Figure 7-8. Input Offset Voltage vs Temperature

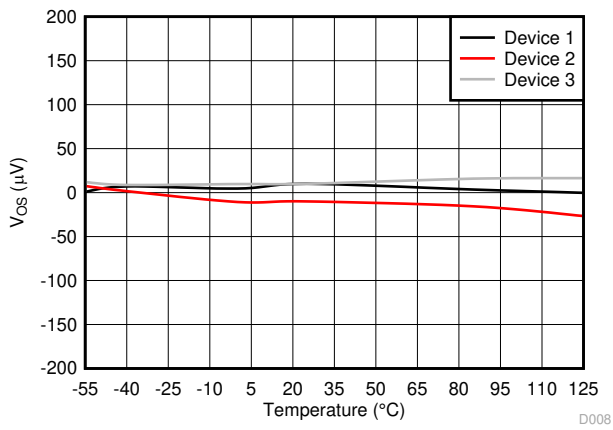

AMC1300B

Figure 7-9. Input Offset Voltage vs Temperature

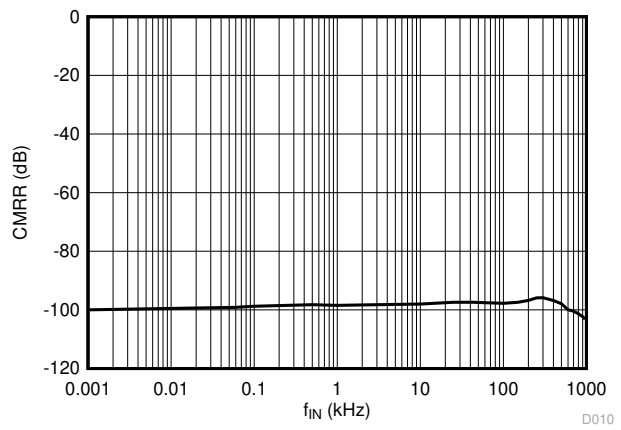

Figure 7-10. Common-Mode Rejection Ratio vs Input Frequency

7.13 Typical Characteristics (continued)

at VDD1 = 5 V, VDD2 = 3.3 V, VINP = -250 mV to 250 mV, VINN = 0 V, and $f_{IN} = 10$ kHz (unless otherwise noted)

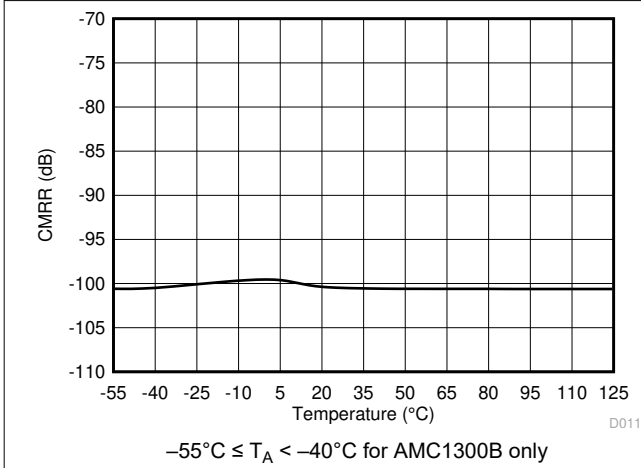

Figure 7-11. Common-Mode Rejection Ratio vs Temperature

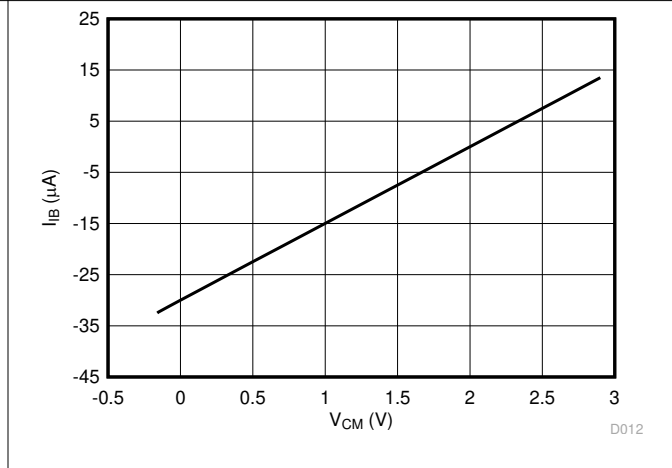

Figure 7-12. Input Bias Current vs Common-Mode Input Voltage

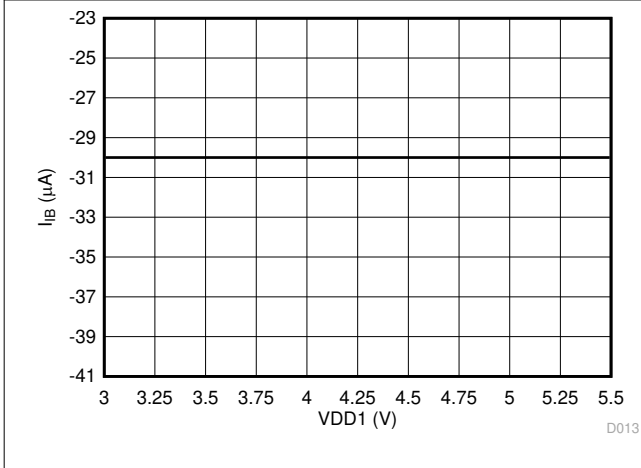

Figure 7-13. Input Bias Current vs High-Side Supply Voltage

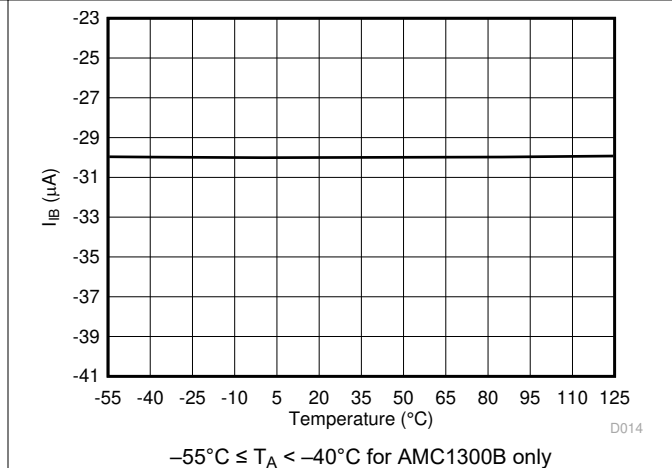

Figure 7-14. Input Bias Current vs Temperature

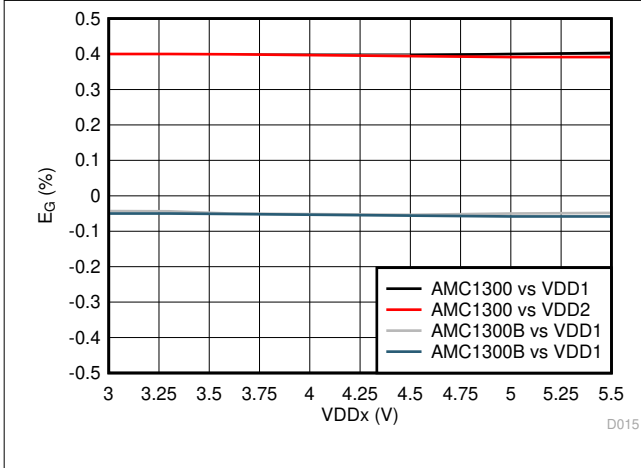

Figure 7-15. Gain Error vs Supply Voltage

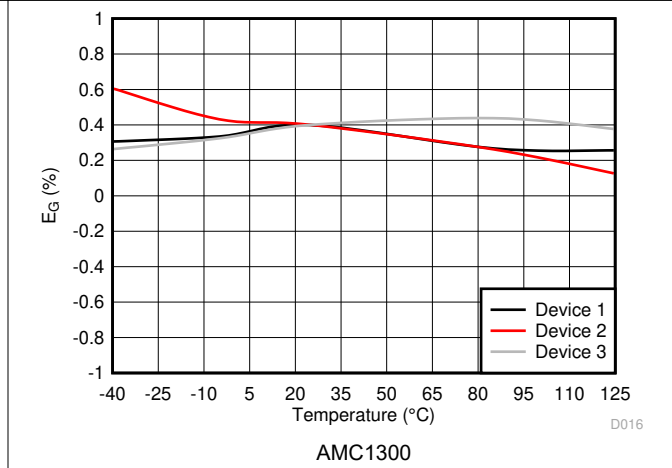

Figure 7-16. Gain Error vs Temperature

7.13 Typical Characteristics (continued)

at VDD1 = 5 V, VDD2 = 3.3 V, VINP = -250 mV to 250 mV, VINN = 0 V, and f_{IN} = 10 kHz (unless otherwise noted)

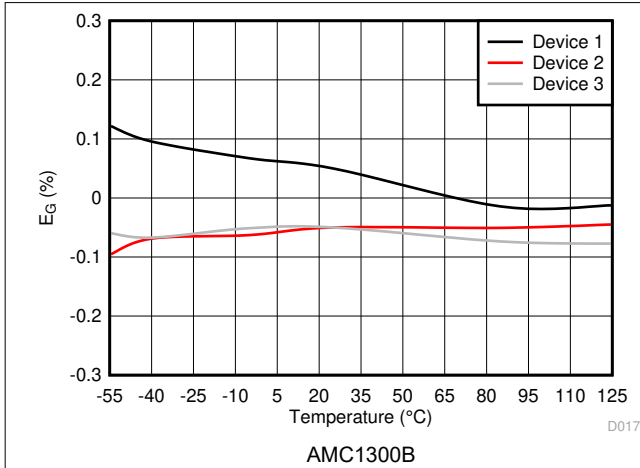

Figure 7-17. Gain Error vs Temperature

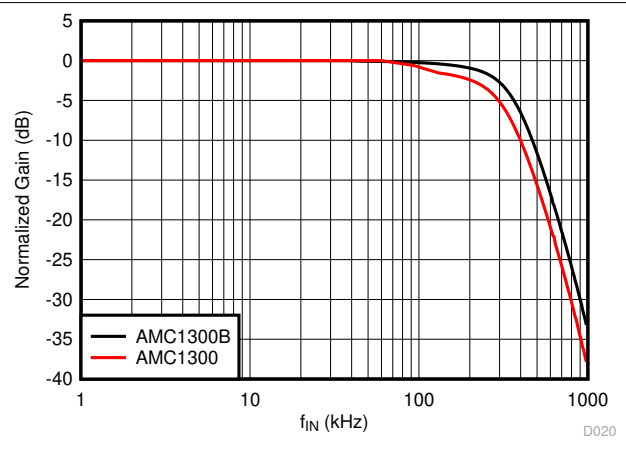

Figure 7-18. Normalized Gain vs Input Frequency

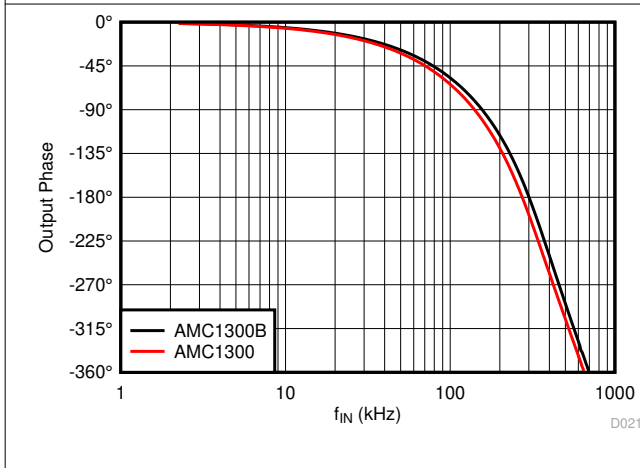

Figure 7-19. Output Phase vs Input Frequency

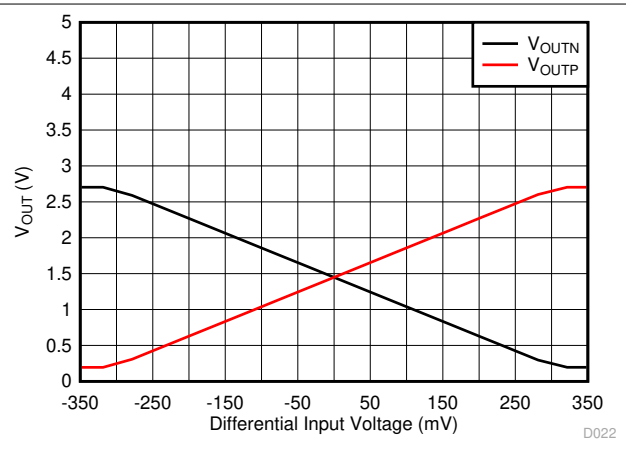

Figure 7-20. Output Voltage vs Input Voltage

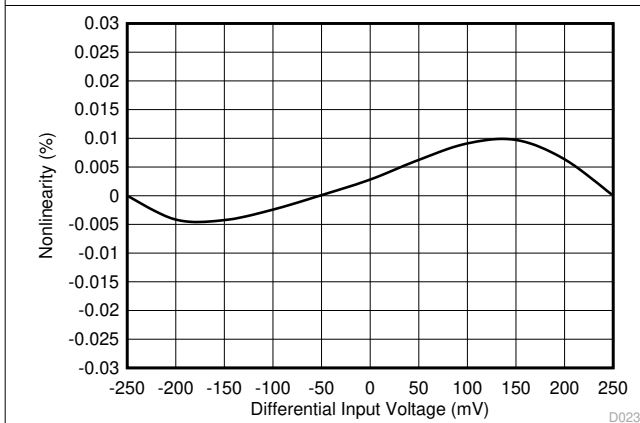

Figure 7-21. Nonlinearity vs Input Voltage

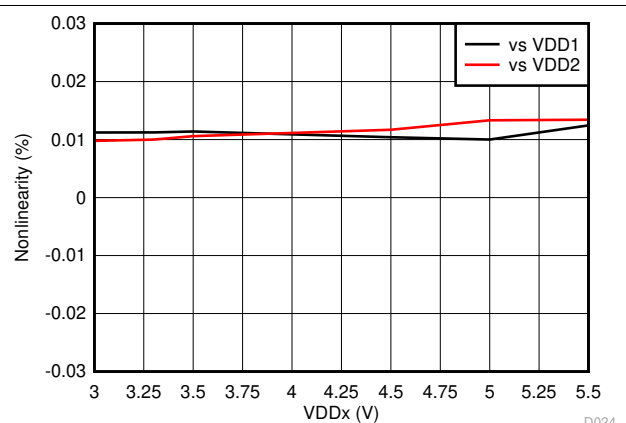
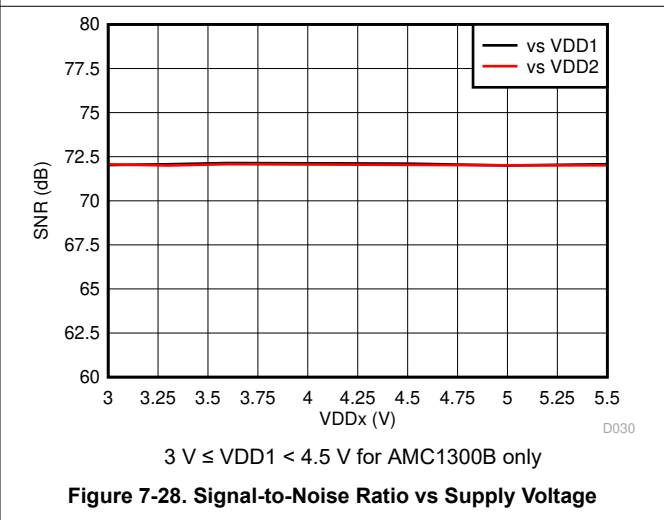
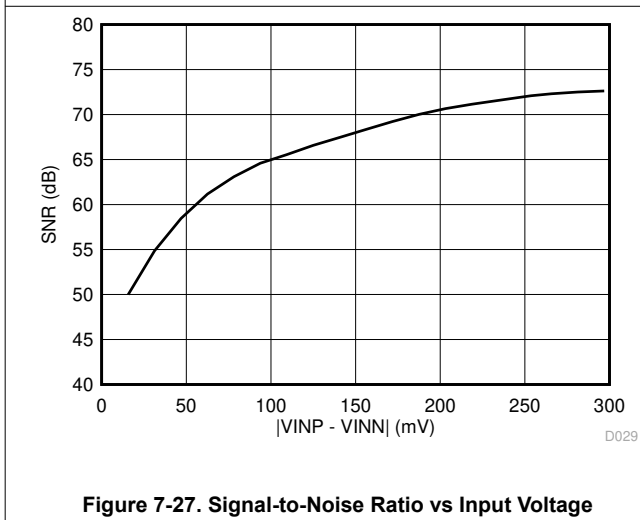
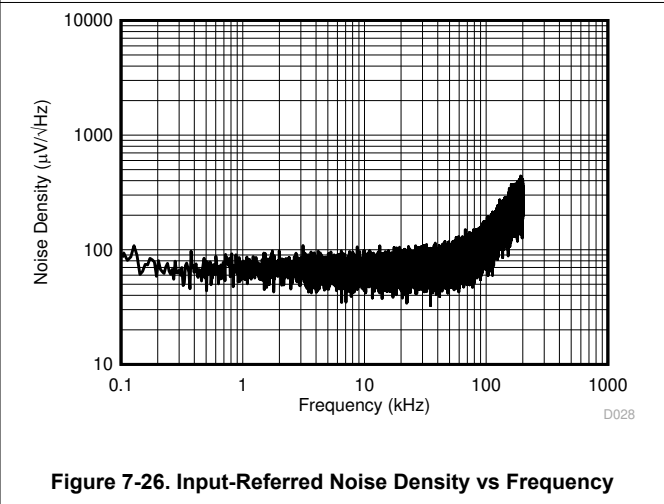
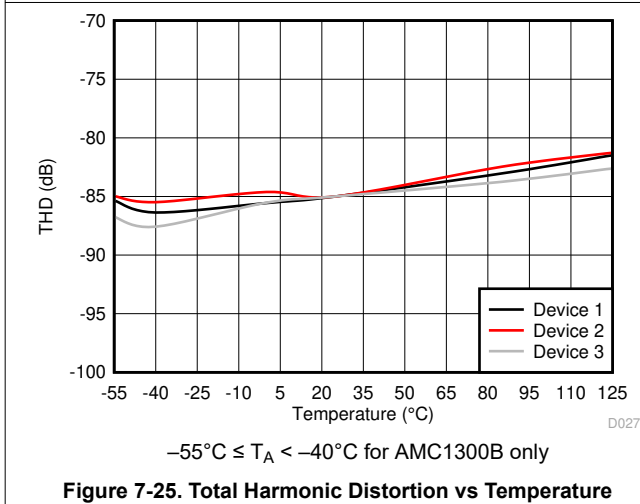
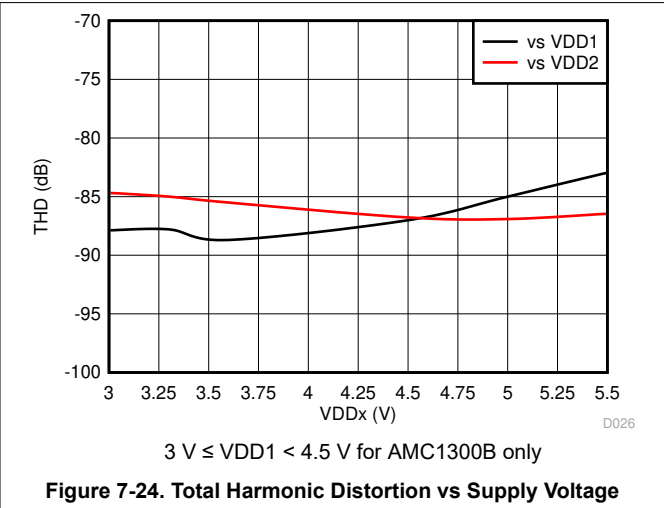
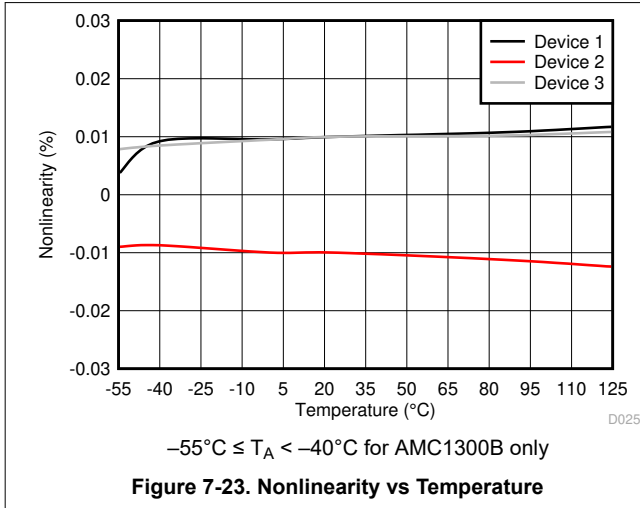

Figure 7-22. Nonlinearity vs Supply Voltage

7.13 Typical Characteristics (continued)

at VDD1 = 5 V, VDD2 = 3.3 V, VINP = -250 mV to 250 mV, VINN = 0 V, and $f_{IN} = 10$ kHz (unless otherwise noted)



7.13 Typical Characteristics (continued)

at VDD1 = 5 V, VDD2 = 3.3 V, VINP = -250 mV to 250 mV, VINN = 0 V, and $f_{IN} = 10$ kHz (unless otherwise noted)

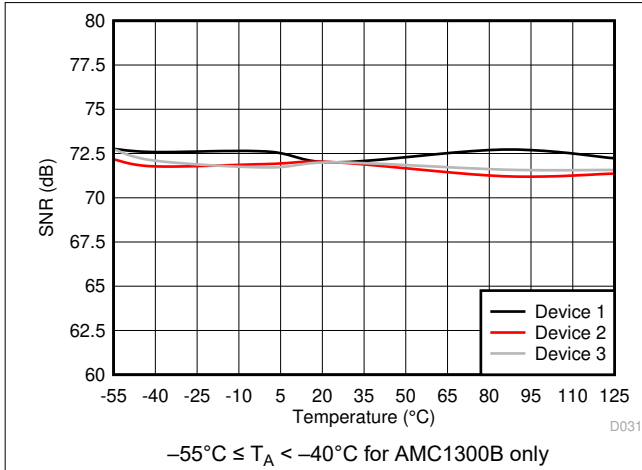

Figure 7-29. Signal-to-Noise Ratio vs Temperature

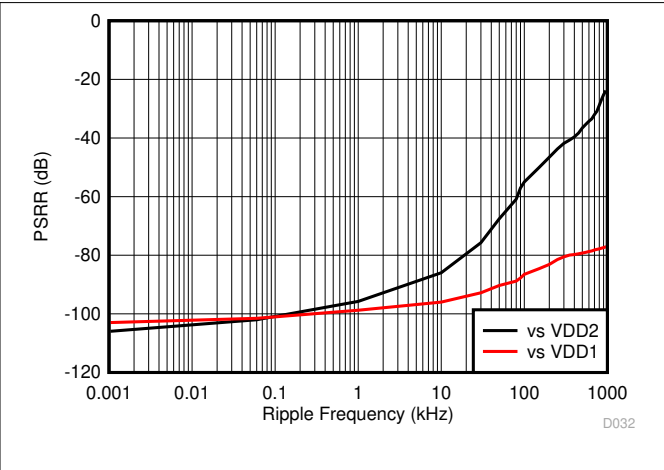

Figure 7-30. Power-Supply Rejection Ratio vs Ripple Frequency

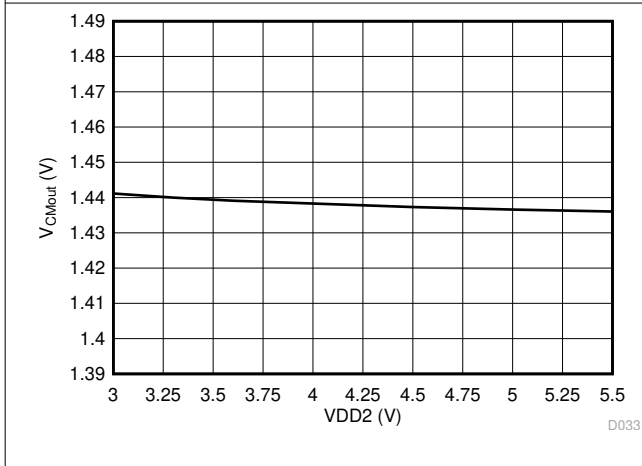

Figure 7-31. Output Common-Mode Voltage vs Low-Side Supply Voltage

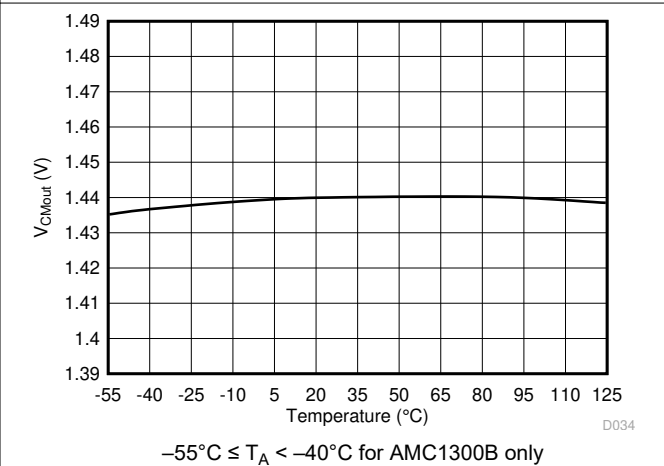

Figure 7-32. Output Common-Mode Voltage vs Temperature

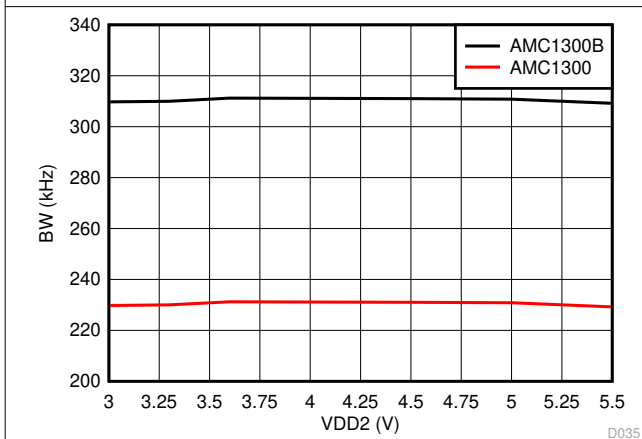

Figure 7-33. Output Bandwidth vs Low-Side Supply Voltage

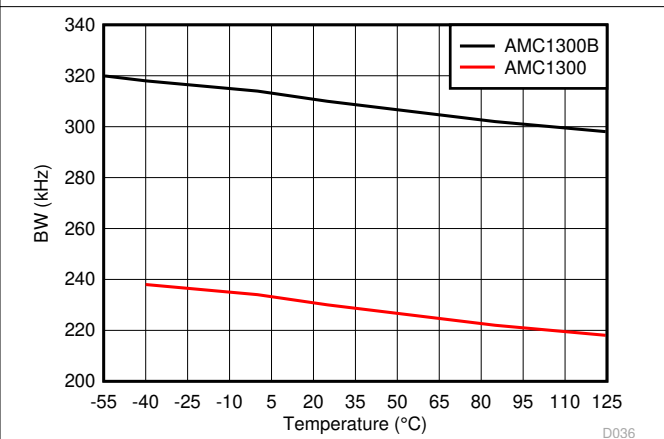
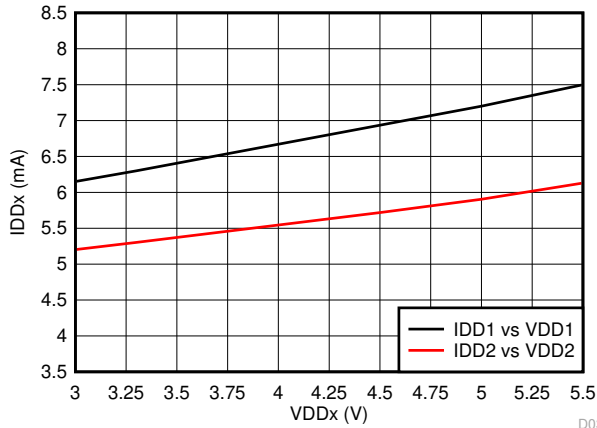

Figure 7-34. Output Bandwidth vs Temperature

7.13 Typical Characteristics (continued)

at VDD1 = 5 V, VDD2 = 3.3 V, VIN = -250 mV to 250 mV, VINN = 0 V, and f_{IN} = 10 kHz (unless otherwise noted)



3 V ≤ VDD1 < 4.5 V for AMC1300B only

Figure 7-35. Supply Current vs Supply Voltage

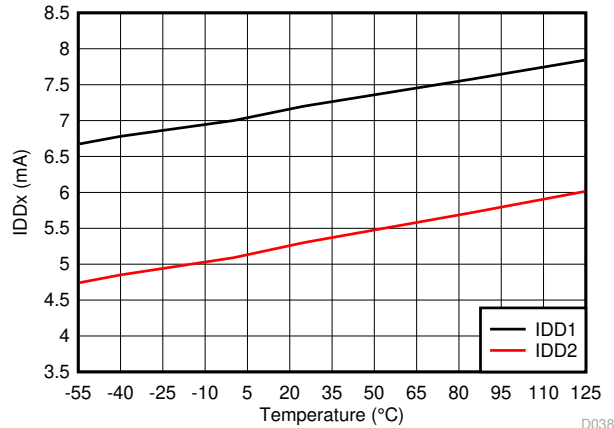

-55°C ≤ T_A < -40°C for AMC1300B only

Figure 7-36. Supply Current vs Temperature

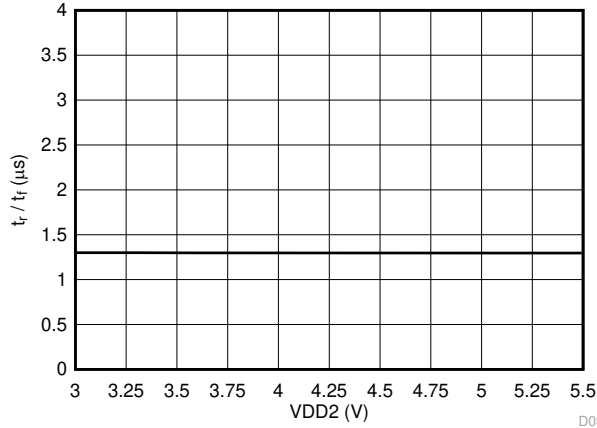
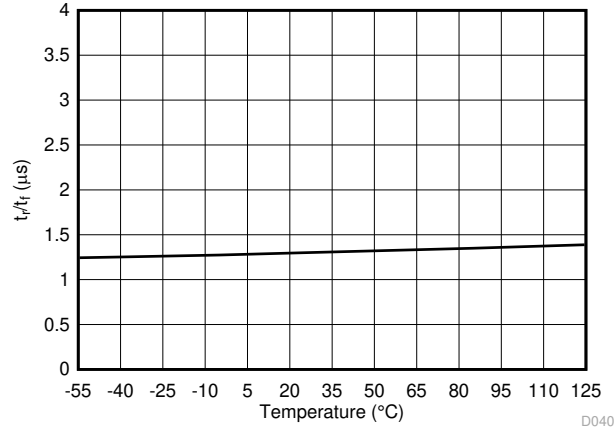
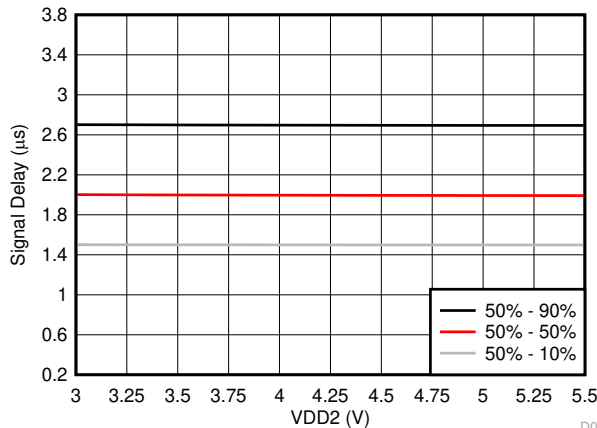

Figure 7-37. Output Rise and Fall Time vs Low-Side Supply



-55°C ≤ T_A < -40°C for AMC1300B only

Figure 7-38. Output Rise and Fall Time vs Temperature



AMC1300

Figure 7-39. V_{IN} to V_{OUT} Signal Delay vs Low-Side Supply Voltage

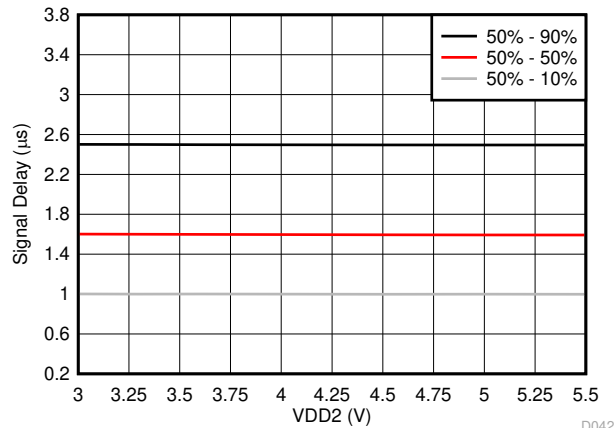

AMC1300B

Figure 7-40. V_{IN} to V_{OUT} Signal Delay vs Low-Side Supply Voltage

7.13 Typical Characteristics (continued)

at VDD1 = 5 V, VDD2 = 3.3 V, VINP = -250 mV to 250 mV, VINN = 0 V, and f_{IN} = 10 kHz (unless otherwise noted)

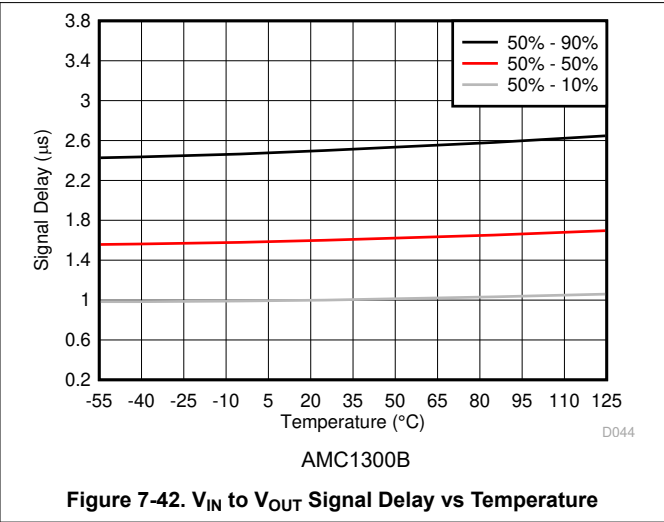
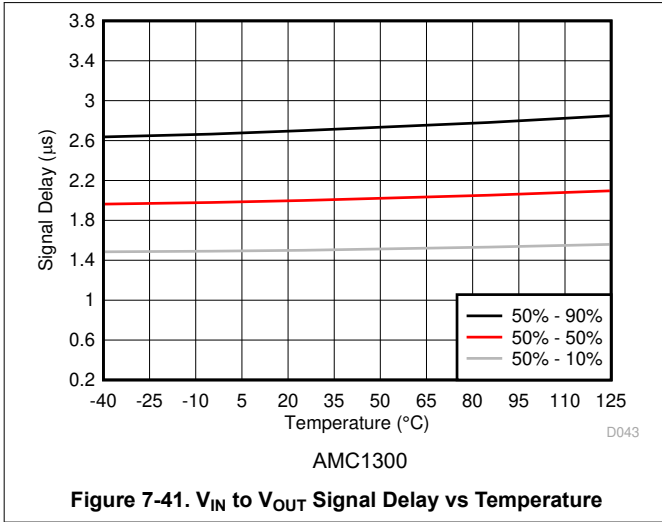

8 Detailed Description

8.1 Overview

The AMC1300 is a fully differential, precision, isolated amplifier. The input stage of the device consists of a fully differential amplifier that drives a second-order, delta-sigma ($\Delta\Sigma$) modulator. The modulator converts the analog input signal into a digital bitstream that is transferred across the isolation barrier that separates the high-side from the low-side. On the low-side, the received bitstream is processed by a fourth-order analog filter that outputs a differential signal at the OUP and OUTN pins that is proportional to the input signal.

The SiO₂-based, capacitive isolation barrier supports a high level of magnetic field immunity, as described in the [ISO72x Digital Isolator Magnetic-Field Immunity application report](#). The digital modulation used in the AMC1300 to transmit data across the isolation barrier, and the isolation barrier characteristics itself, result in high reliability and common-mode transient immunity.

8.2 Functional Block Diagram

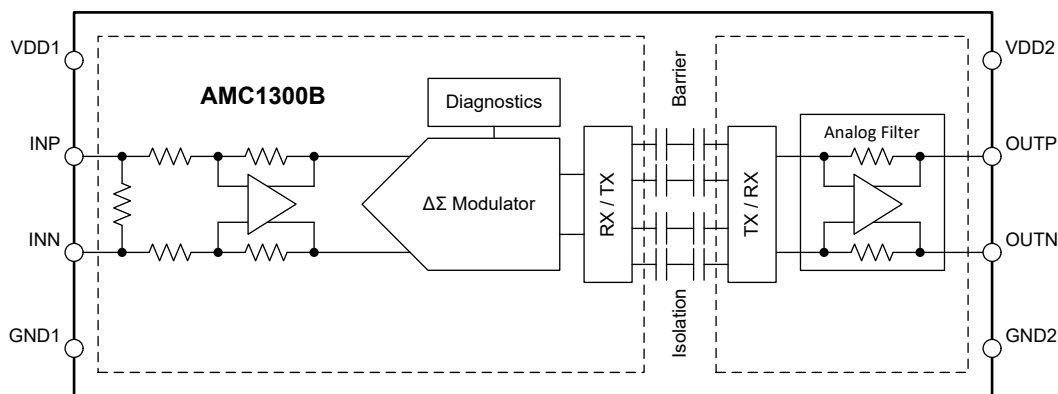

8.3 Feature Description

8.3.1 Analog Input

The differential amplifier input stage of the AMC1300 feeds a second-order, switched-capacitor, feed-forward $\Delta\Sigma$ modulator. The gain of the differential amplifier is set by internal precision resistors with a differential input impedance of R_{IND} . The modulator converts the analog input signal into a bitstream that is transferred across the isolation barrier, as described in the [Isolation Channel Signal Transmission](#) section.

There are two restrictions on the analog input signals INP and INN. First, if the input voltages V_{INP} or V_{INN} exceed the range specified in the [Absolute Maximum Ratings](#) table, the input currents must be limited to the absolute maximum value, because the electrostatic discharge (ESD) protection turns on. In addition, the linearity and parametric performance of the device are ensured only when the analog input voltage remains within the linear full-scale range (V_{FSR}) and within the common-mode input voltage range (V_{CM}) as specified in the [Recommended Operating Conditions](#) table.

8.3.2 Isolation Channel Signal Transmission

The AMC1300 uses an on-off keying (OOK) modulation scheme, as shown in [Figure 8-1](#), to transmit the modulator output bitstream across the SiO₂-based isolation barrier. The transmit driver (TX) shown in the [Functional Block Diagram](#) transmits an internally generated, high-frequency carrier across the isolation barrier to represent a digital *one* and does not send a signal to represent a digital *zero*. The nominal frequency of the carrier used inside the AMC1300 is 480 MHz.

The receiver (RX) on the other side of the isolation barrier recovers and demodulates the signal and provides the input to the fourth-order analog filter. The AMC1300 transmission channel is optimized to achieve the highest level of common-mode transient immunity (CMTI) and lowest level of radiated emissions caused by the high-frequency carrier and RX/TX buffer switching.

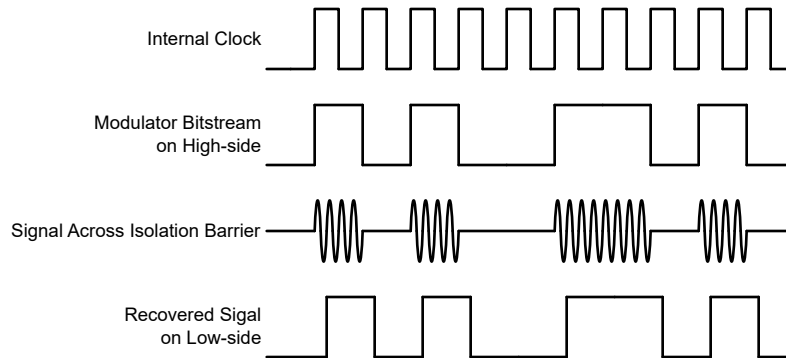

Figure 8-1. OOK-Based Modulation Scheme

8.3.3 Analog Output

The AMC1300 offers a differential analog output comprised of the OOUTP and OOUTN pins. For differential input voltages ($V_{INP} - V_{INN}$) in the range from -250 mV to $+250$ mV, the device provides a linear response with a nominal gain of 8.2. For example, for a differential input voltage of 250 mV, the differential output voltage ($V_{OOUTP} - V_{OOUTN}$) is 2.05 V. At zero input (INP shorted to INN), both pins output the same common-mode output voltage V_{CMout} , as specified in the [Electrical Characteristics](#) table. For absolute differential input voltages greater than 250 mV but less than 320 mV, the differential output voltage continues to increase in magnitude but with reduced linearity performance. The outputs saturate at a differential output voltage of $V_{CLIPout}$, as shown in [Figure 8-2](#), if the differential input voltage exceeds the $V_{Clipping}$ value.

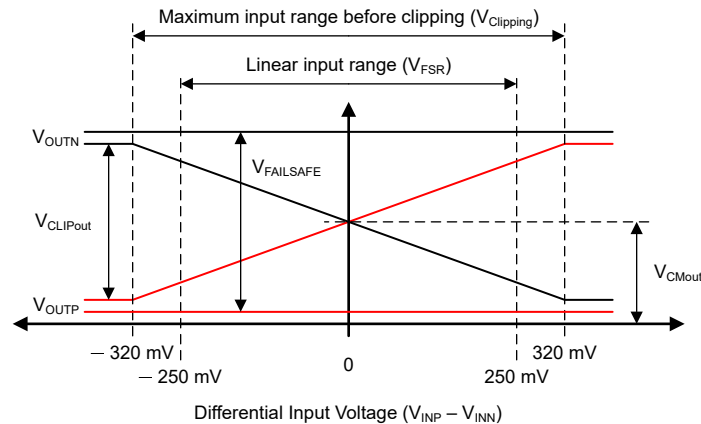

Figure 8-2. Output Behavior of the AMC1300

The AMC1300 offers a fail-safe feature that simplifies diagnostics on system level. [Figure 8-2](#) shows the fail-safe potential that is a negative differential output voltage that does not occur under normal operating conditions. The fail-safe output is active in two cases:

- When the high-side supply is missing or below the $V_{DD1_{UV}}$ threshold
- When the common-mode input voltage, that is $V_{CM} = (V_{INP} + V_{INN}) / 2$, exceeds the common-mode overvoltage detection level V_{CMov}

Use the maximum $V_{FAILSAFE}$ voltage specified in the [Electrical Characteristics](#) table as a reference value for fail-safe detection on system level.

8.4 Device Functional Modes

The AMC1300 is operational when the power supplies V_{DD1} and V_{DD2} are applied, as specified in the [Recommended Operating Conditions](#) table.

9 Application and Implementation

Note

Information in the following applications sections is not part of the TI component specification, and TI does not warrant its accuracy or completeness. TI's customers are responsible for determining suitability of components for their purposes, as well as validating and testing their design implementation to confirm system functionality.

9.1 Application Information

The low analog input voltage range, excellent accuracy, and low temperature drift make the AMC1300 a high-performance solution for industrial applications where shunt-based current sensing in the presence of high common-mode voltage levels is required.

9.2 Typical Application

The AMC1300 is ideally suited for shunt-based current sensing applications where accurate current monitoring is required in the presence of high common-mode voltages.

Figure 9-1 shows the AMC1300 in a typical application. The load current flowing through an external shunt resistor RSHUNT produces a voltage drop that is sensed by the AMC1300. The AMC1300 digitizes the analog input signal on the high-side, transfers the data across the isolation barrier to the low-side, reconstructs the analog signal, and presents that signal as a differential voltage on the output pins.

The differential input, differential output, and the high common-mode transient immunity (CMTI) of the AMC1300 ensure reliable and accurate operation even in high-noise environments.

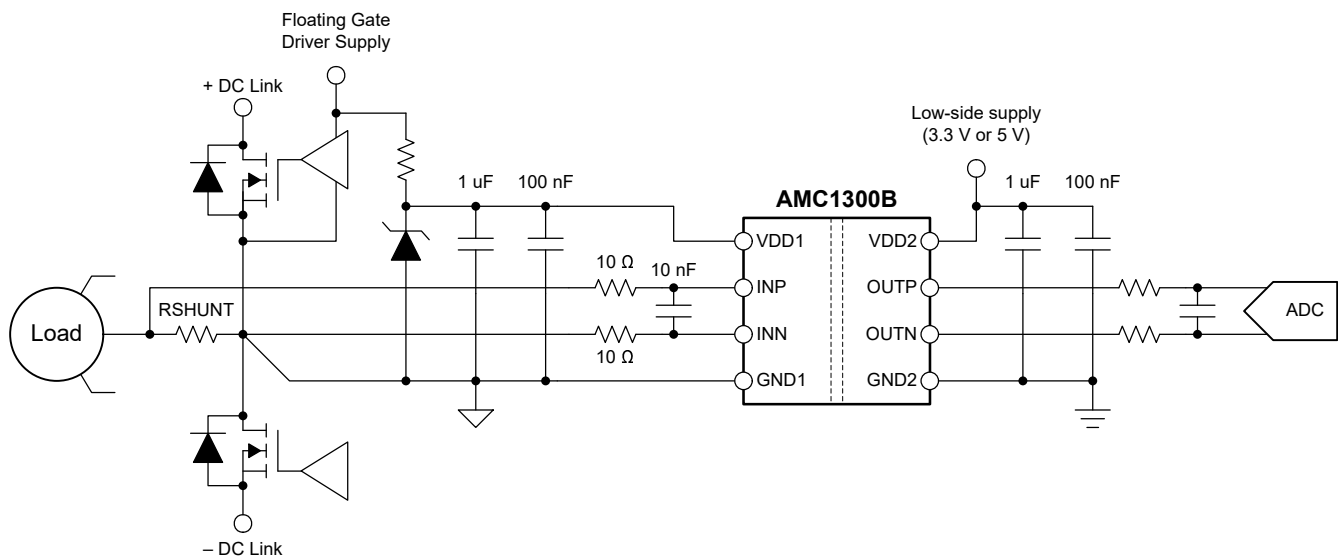

Figure 9-1. Using the AMC1300 for Current Sensing in a Typical Application

9.2.1 Design Requirements

Table 9-1 lists the parameters for this typical application.

Table 9-1. Design Requirements

PARAMETER	VALUE
High-side supply voltage	3.3 V or 5 V
Low-side supply voltage	3.3 V or 5 V
Voltage drop across RSHUNT for a linear response	± 250 mV (maximum)
Signal delay (50% VIN to 90% OUTP, OUTN)	3 μs (maximum)

9.2.2 Detailed Design Procedure

In Figure 9-1, the high-side power supply (VDD1) for the AMC1300 is derived from the floating power supply of the upper gate driver.

The floating ground reference (GND1) is derived from the end of the shunt resistor that is connected to the negative input of the AMC1300 (INN). If a four-pin shunt is used, the inputs of the AMC1300 are connected to the inner leads and GND1 is connected to the outer lead on the INN-side of the shunt. To minimize offset and improve accuracy, route the ground connection as a separate trace that connects directly to the shunt resistor rather than shorting GND1 to INN directly at the input to the device.

9.2.2.1 Shunt Resistor Sizing

Use Ohm's Law to calculate the voltage drop across the shunt resistor (V_{SHUNT}) for the desired measured current: $V_{SHUNT} = I \times R_{SHUNT}$.

Consider the following two restrictions when selecting the value of the shunt resistor, R_{SHUNT} :

- The voltage drop caused by the nominal current range must not exceed the recommended differential input voltage range for a linear response: $|V_{SHUNT}| \leq |V_{FSR}|$
- The voltage drop caused by the maximum allowed overcurrent must not exceed the input voltage that causes a clipping output: $|V_{SHUNT}| \leq |V_{Clipping}|$

9.2.2.2 Input Filter Design

TI recommends placing an RC filter in front of the isolated amplifier to improve signal-to-noise performance of the signal path. Design the input filter such that:

- The cutoff frequency of the filter is at least one order of magnitude lower than the sampling frequency (20 MHz) of the $\Delta\Sigma$ modulator
- The input bias current does not generate significant voltage drop across the DC impedance of the input filter
- The impedances measured from the analog inputs are equal

For most applications, the structure shown in Figure 9-2 achieves excellent performance.

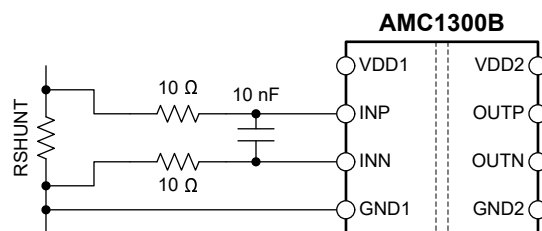

Figure 9-2. Differential Input Filter

9.2.2.3 Differential-to-Single-Ended Output Conversion

Figure 9-3 shows an example of a TLV6001-based signal conversion and filter circuit for systems using single-ended-input ADCs to convert the analog output voltage into digital. With $R1 = R2 = R3 = R4$, the output voltage equals $(V_{OUTP} - V_{OUTN}) + V_{REF}$. Tailor the bandwidth of this filter stage to the bandwidth requirement of the system. For most applications, $R1 = R2 = R3 = R4 = 3.3\text{ k}\Omega$ and $C1 = C2 = 330\text{ pF}$ yields good performance.

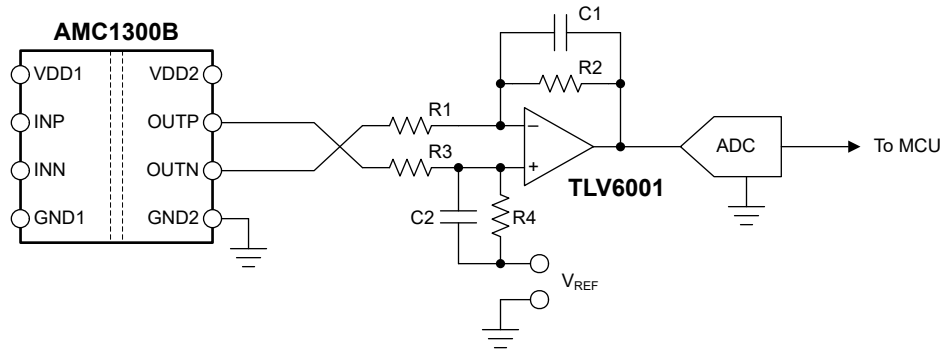

Figure 9-3. Connecting the AMC1300 Output to a Single-Ended Input ADC

For more information on the general procedure to design the filtering and driving stages of SAR ADCs, see the [18-Bit, 1MSPS Data Acquisition Block \(DAQ\) Optimized for Lowest Distortion and Noise](#) and [18-Bit Data Acquisition Block \(DAQ\) Optimized for Lowest Power](#) reference guides, available for download at www.ti.com.

9.2.3 Application Curves

One important aspect of power-stage design is the effective detection of an overcurrent condition to protect the switching devices and passive components from damage. To power off the system quickly in the event of an overcurrent condition, a low delay caused by the isolated amplifier is required. Figure 9-4 shows the typical full-scale step response of the AMC1300.

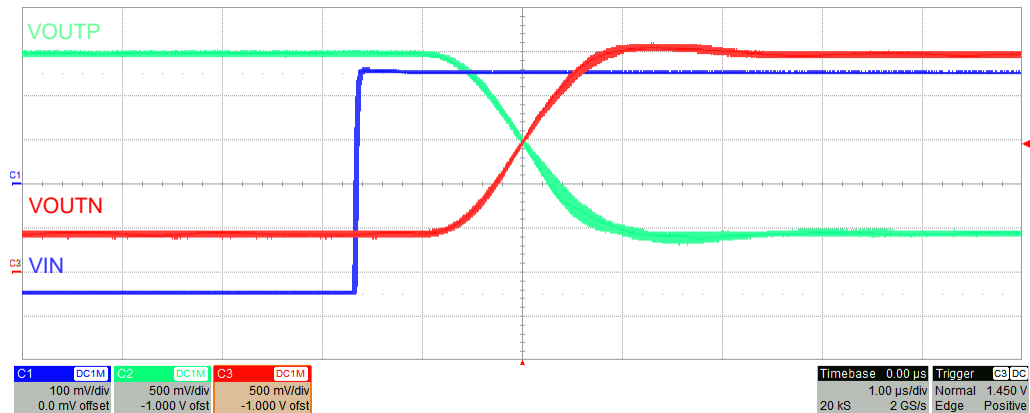

Figure 9-4. Step Response of the AMC1300

9.3 What To Do and What Not To Do

Do not leave the inputs of the AMC1300 unconnected (floating) when the device is powered up. If the device inputs are left floating, the input bias current may drive the inputs to a positive value that exceeds the operating common-mode input voltage and the device outputs the fail-safe voltage as described in the [Analog Output](#) section.

Connect the high-side ground (GND1) to INN, either by a hard short or through a resistive path. A DC current path between INN and GND1 is required to define the input common-mode voltage. Do not exceed the input common-mode range specified in the [Recommended Operating Conditions](#) table. For best accuracy, route the ground connection as a separate trace that connects directly to the shunt resistor rather than shorting GND1 to INN directly at the input to the device. See the [Layout](#) section for more details.

10 Power Supply Recommendations

The AMC1300 does not require any specific power up sequencing. The high-side power-supply (VDD1) is decoupled with a low-ESR, 100-nF capacitor (C1) parallel to a low-ESR, 1- μ F capacitor (C2). The low-side power supply (VDD2) is equally decoupled with a low-ESR, 100-nF capacitor (C3) parallel to a low-ESR, 1- μ F capacitor (C4). Place all four capacitors (C1, C2, C3, and C4) as close to the device as possible.

The ground reference for the high-side (GND1) is derived from the end of the shunt resistor, which is connected to the negative input (INN) of the device. For best DC accuracy, use a separate trace (as shown in Figure 10-1) to make this connection instead of shorting GND1 to INN directly at the device input. If a four-terminal shunt is used, the device inputs are connected to the inner leads and GND1 is connected to the outer lead on the INN-side of the shunt.

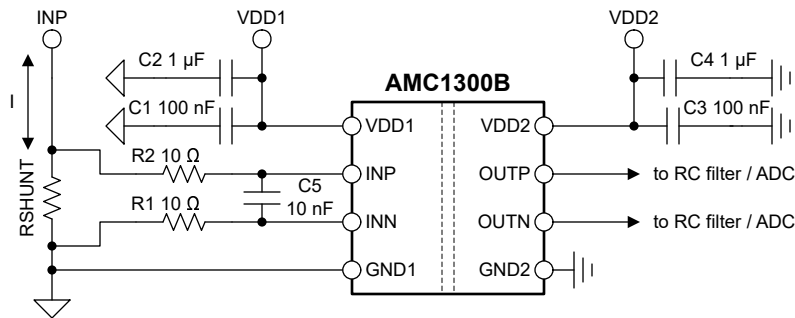

Figure 10-1. Decoupling of the AMC1300

Capacitors must provide adequate effective capacitance under the applicable DC bias conditions they experience in the application. Multilayer ceramic capacitors (MLCCs) typically exhibit only a fraction of their nominal capacitance under real-world conditions and this factor must be taken into consideration when selecting these capacitors. This problem is especially acute in low-profile capacitors, in which the dielectric field strength is higher than in taller components. Reputable capacitor manufacturers provide capacitance versus DC bias curves that greatly simplify component selection.

11 Layout

11.1 Layout Guidelines

Figure 11-1 shows a layout recommendation with the critical placement of the decoupling capacitors (as close as possible to the AMC1300 supply pins) and placement of the other components required by the device. For best performance, place the shunt resistor close to the INP and INN inputs of the AMC1300 and keep the layout of both connections symmetrical.

11.2 Layout Example

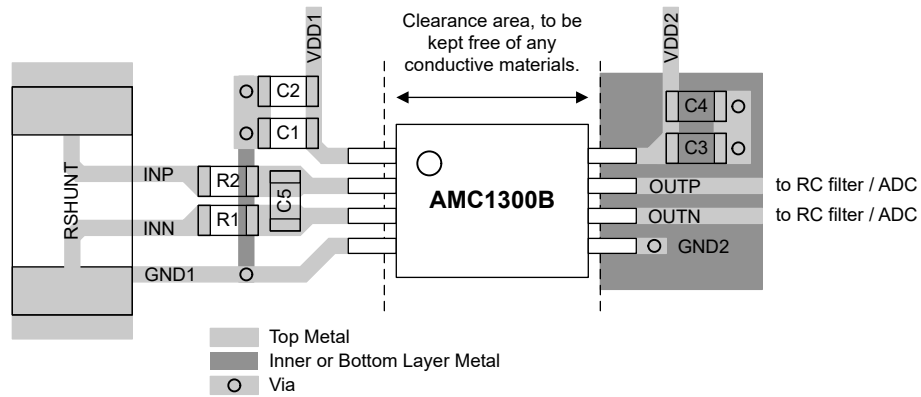

Figure 11-1. Recommended Layout of the AMC1300

12 Device and Documentation Support

12.1 Documentation Support

12.1.1 Related Documentation

For related documentation, see the following:

- Texas Instruments, [Isolation Glossary application report](#)
- Texas Instruments, [Semiconductor and IC Package Thermal Metrics application report](#)
- Texas Instruments, [ISO72x Digital Isolator Magnetic-Field Immunity application report](#)
- Texas Instruments, [TLV600x Low-Power, Rail-to-Rail In/Out, 1-MHz Operational Amplifier for Cost-Sensitive Systems data sheet](#)
- Texas Instruments, [18-Bit, 1-MSPS Data Acquisition Block \(DAQ\) Optimized for Lowest Distortion and Noise reference guide](#)
- Texas Instruments, [18-Bit, 1-MSPS Data Acquisition Block \(DAQ\) Optimized for Lowest Power reference guide](#)
- Texas Instruments, [Isolated Amplifier Voltage Sensing Excel Calculator design tool](#)

12.2 Receiving Notification of Documentation Updates

To receive notification of documentation updates, navigate to the device product folder on [ti.com](#). Click on *Subscribe to updates* to register and receive a weekly digest of any product information that has changed. For change details, review the revision history included in any revised document.

12.3 Support Resources

[TI E2E™ support forums](#) are an engineer's go-to source for fast, verified answers and design help — straight from the experts. Search existing answers or ask your own question to get the quick design help you need.

Linked content is provided "AS IS" by the respective contributors. They do not constitute TI specifications and do not necessarily reflect TI's views; see TI's [Terms of Use](#).

12.4 Trademarks

TI E2E™ is a trademark of Texas Instruments.
All trademarks are the property of their respective owners.

12.5 Electrostatic Discharge Caution



This integrated circuit can be damaged by ESD. Texas Instruments recommends that all integrated circuits be handled with appropriate precautions. Failure to observe proper handling and installation procedures can cause damage.

ESD damage can range from subtle performance degradation to complete device failure. Precision integrated circuits may be more susceptible to damage because very small parametric changes could cause the device not to meet its published specifications.

12.6 Glossary

[TI Glossary](#) This glossary lists and explains terms, acronyms, and definitions.

13 Mechanical, Packaging, and Orderable Information

The following pages include mechanical, packaging, and orderable information. This information is the most current data available for the designated devices. This data is subject to change without notice and revision of this document. For browser-based versions of this data sheet, refer to the left-hand navigation.

PACKAGING INFORMATION

Orderable Device	Status (1)	Package Type	Package Drawing	Pins	Package Qty	Eco Plan (2)	Lead finish/ Ball material (6)	MSL Peak Temp (3)	Op Temp (°C)	Device Marking (4/5)	Samples
AMC1300BDWV	ACTIVE	SOIC	DWV	8	64	RoHS & Green	NIPDAU	Level-3-260C-168 HR	-55 to 125	AMC1300B	Samples
AMC1300BDWVR	ACTIVE	SOIC	DWV	8	1000	RoHS & Green	NIPDAU	Level-3-260C-168 HR	-55 to 125	AMC1300B	Samples
AMC1300DWV	ACTIVE	SOIC	DWV	8	64	RoHS & Green	NIPDAU	Level-3-260C-168 HR	-40 to 125	AMC1300	Samples
AMC1300DWVR	ACTIVE	SOIC	DWV	8	1000	RoHS & Green	NIPDAU	Level-3-260C-168 HR	-40 to 125	AMC1300	Samples

(1) The marketing status values are defined as follows:

ACTIVE: Product device recommended for new designs.

LIFEBUY: TI has announced that the device will be discontinued, and a lifetime-buy period is in effect.

NRND: Not recommended for new designs. Device is in production to support existing customers, but TI does not recommend using this part in a new design.

PREVIEW: Device has been announced but is not in production. Samples may or may not be available.

OBSOLETE: TI has discontinued the production of the device.

(2) **RoHS:** TI defines "RoHS" to mean semiconductor products that are compliant with the current EU RoHS requirements for all 10 RoHS substances, including the requirement that RoHS substance do not exceed 0.1% by weight in homogeneous materials. Where designed to be soldered at high temperatures, "RoHS" products are suitable for use in specified lead-free processes. TI may reference these types of products as "Pb-Free".

RoHS Exempt: TI defines "RoHS Exempt" to mean products that contain lead but are compliant with EU RoHS pursuant to a specific EU RoHS exemption.

Green: TI defines "Green" to mean the content of Chlorine (Cl) and Bromine (Br) based flame retardants meet JS709B low halogen requirements of <=1000ppm threshold. Antimony trioxide based flame retardants must also meet the <=1000ppm threshold requirement.

(3) MSL, Peak Temp. - The Moisture Sensitivity Level rating according to the JEDEC industry standard classifications, and peak solder temperature.

(4) There may be additional marking, which relates to the logo, the lot trace code information, or the environmental category on the device.

(5) Multiple Device Markings will be inside parentheses. Only one Device Marking contained in parentheses and separated by a "-" will appear on a device. If a line is indented then it is a continuation of the previous line and the two combined represent the entire Device Marking for that device.

(6) Lead finish/Ball material - Orderable Devices may have multiple material finish options. Finish options are separated by a vertical ruled line. Lead finish/Ball material values may wrap to two lines if the finish value exceeds the maximum column width.

Important Information and Disclaimer:The information provided on this page represents TI's knowledge and belief as of the date that it is provided. TI bases its knowledge and belief on information provided by third parties, and makes no representation or warranty as to the accuracy of such information. Efforts are underway to better integrate information from third parties. TI has taken and

continues to take reasonable steps to provide representative and accurate information but may not have conducted destructive testing or chemical analysis on incoming materials and chemicals. TI and TI suppliers consider certain information to be proprietary, and thus CAS numbers and other limited information may not be available for release.

In no event shall TI's liability arising out of such information exceed the total purchase price of the TI part(s) at issue in this document sold by TI to Customer on an annual basis.

TAPE AND REEL INFORMATION

QUADRANT ASSIGNMENTS FOR PIN 1 ORIENTATION IN TAPE

*All dimensions are nominal

Device	Package Type	Package Drawing	Pins	SPQ	Reel Diameter (mm)	Reel Width W1 (mm)	A0 (mm)	B0 (mm)	K0 (mm)	P1 (mm)	W (mm)	Pin1 Quadrant
AMC1300BDWVR	SOIC	DWV	8	1000	330.0	16.4	12.05	6.15	3.3	16.0	16.0	Q1
AMC1300DWVR	SOIC	DWV	8	1000	330.0	16.4	12.05	6.15	3.3	16.0	16.0	Q1

TAPE AND REEL BOX DIMENSIONS

*All dimensions are nominal

Device	Package Type	Package Drawing	Pins	SPQ	Length (mm)	Width (mm)	Height (mm)
AMC1300BDWVR	SOIC	DWV	8	1000	350.0	350.0	43.0
AMC1300DWVR	SOIC	DWV	8	1000	350.0	350.0	43.0

TUBE

*All dimensions are nominal

Device	Package Name	Package Type	Pins	SPQ	L (mm)	W (mm)	T (μm)	B (mm)
AMC1300BDWV	DWV	SOIC	8	64	505.46	13.94	4826	6.6
AMC1300DWV	DWV	SOIC	8	64	505.46	13.94	4826	6.6



DWV0008A

SOIC - 2.8 mm max height

SOIC

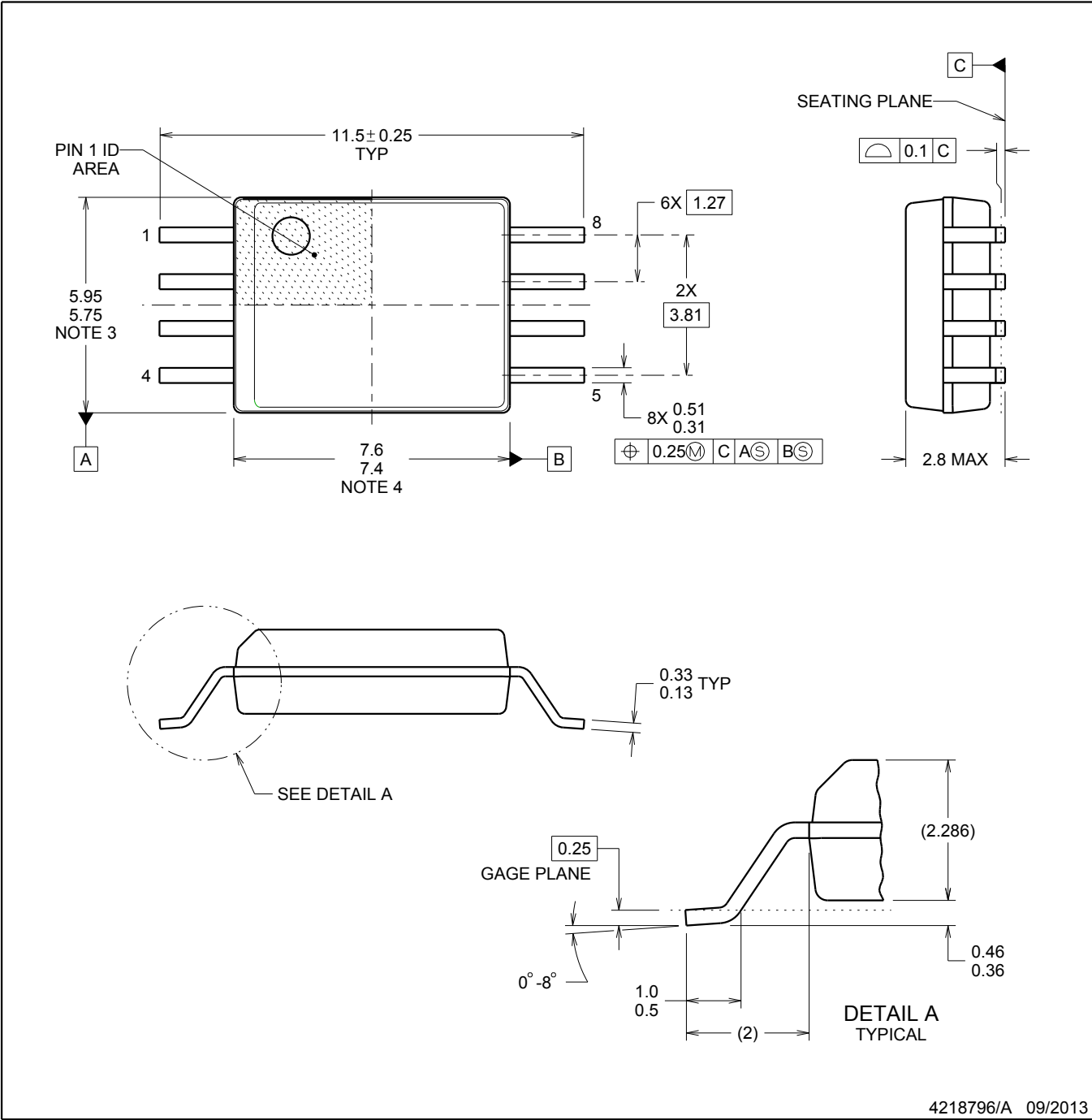

4218796/A 09/2013

NOTES:

1. All linear dimensions are in millimeters. Dimensions in parenthesis are for reference only. Dimensioning and tolerancing per ASME Y14.5M.
2. This drawing is subject to change without notice.
3. This dimension does not include mold flash, protrusions, or gate burrs. Mold flash, protrusions, or gate burrs shall not exceed 0.15 mm, per side.
4. This dimension does not include interlead flash. Interlead flash shall not exceed 0.25 mm, per side.

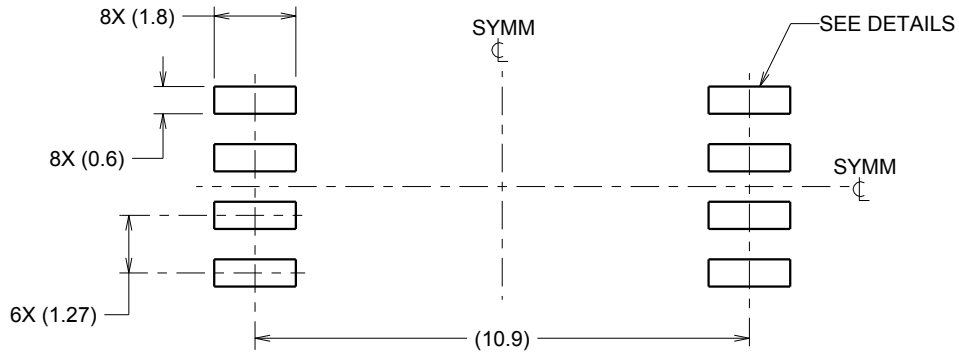

LAND PATTERN EXAMPLE
9.1 mm NOMINAL CLEARANCE/CREEPAGE
SCALE:6X

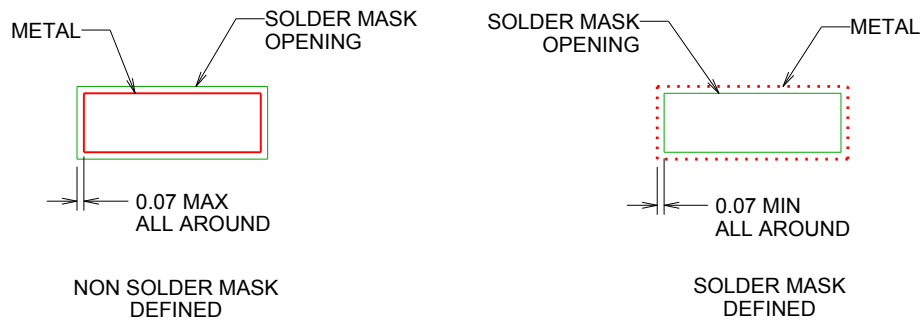

SOLDER MASK DETAILS

4218796/A 09/2013

NOTES: (continued)

- 5. Publication IPC-7351 may have alternate designs.
- 6. Solder mask tolerances between and around signal pads can vary based on board fabrication site.

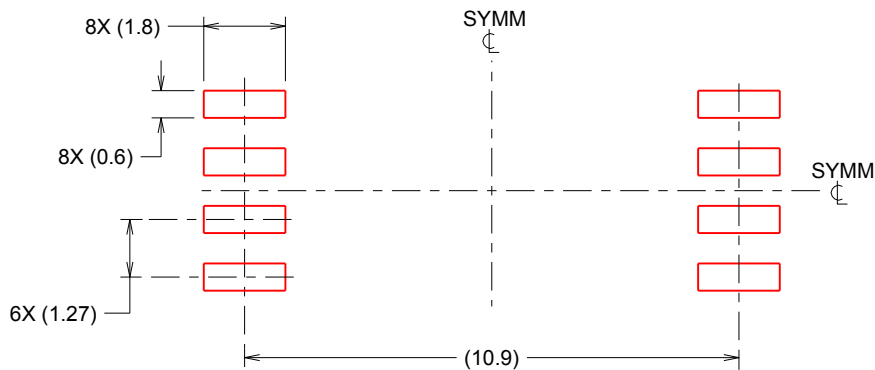

SOLDER PASTE EXAMPLE
 BASED ON 0.125 mm THICK STENCIL
 SCALE:6X

4218796/A 09/2013

NOTES: (continued)

- 7. Laser cutting apertures with trapezoidal walls and rounded corners may offer better paste release. IPC-7525 may have alternate design recommendations.
- 8. Board assembly site may have different recommendations for stencil design.

IMPORTANT NOTICE AND DISCLAIMER

TI PROVIDES TECHNICAL AND RELIABILITY DATA (INCLUDING DATA SHEETS), DESIGN RESOURCES (INCLUDING REFERENCE DESIGNS), APPLICATION OR OTHER DESIGN ADVICE, WEB TOOLS, SAFETY INFORMATION, AND OTHER RESOURCES "AS IS" AND WITH ALL FAULTS, AND DISCLAIMS ALL WARRANTIES, EXPRESS AND IMPLIED, INCLUDING WITHOUT LIMITATION ANY IMPLIED WARRANTIES OF MERCHANTABILITY, FITNESS FOR A PARTICULAR PURPOSE OR NON-INFRINGEMENT OF THIRD PARTY INTELLECTUAL PROPERTY RIGHTS.

These resources are intended for skilled developers designing with TI products. You are solely responsible for (1) selecting the appropriate TI products for your application, (2) designing, validating and testing your application, and (3) ensuring your application meets applicable standards, and any other safety, security, regulatory or other requirements.

These resources are subject to change without notice. TI grants you permission to use these resources only for development of an application that uses the TI products described in the resource. Other reproduction and display of these resources is prohibited. No license is granted to any other TI intellectual property right or to any third party intellectual property right. TI disclaims responsibility for, and you will fully indemnify TI and its representatives against, any claims, damages, costs, losses, and liabilities arising out of your use of these resources.

TI's products are provided subject to [TI's Terms of Sale](#) or other applicable terms available either on ti.com or provided in conjunction with such TI products. TI's provision of these resources does not expand or otherwise alter TI's applicable warranties or warranty disclaimers for TI products.

TI objects to and rejects any additional or different terms you may have proposed.

Mailing Address: Texas Instruments, Post Office Box 655303, Dallas, Texas 75265
Copyright © 2022, Texas Instruments Incorporated