

EM1402 Evaluation Module

This user's guide describes the general features, theory of operation, hardware setup, and use of the EM1402EVM. Throughout this user's guide, the abbreviations *EVM*, *EM1402EVM*, and the term *evaluation module* are synonymous with the *EM1402 Evaluation Module*, unless otherwise noted. This EVM is an evaluation board of the *Active Balance* chipset for use in large format Lithium-ion batteries that provides monitoring, balancing, and communications.

Contents

1	EM1402 Evaluation Module	2
2	General Description	3
	2.1 Key Features	3
	2.2 Key Electrical Parameters	3
3	Theory of Operation	4
	3.1 Single Board	6
	3.2 Stacked Systems	6
4	Hardware Setup	6
	4.1 Connectors	6
5	EM1402EVM Quick Start Guide	10
	5.1 Before You Begin	10
	5.2 Hardware Setup	11
	5.3 Connecting the Evaluation Modules	11
	5.4 Software	12
6	Physical Dimensions	13
	6.1 Board Dimensions	13
	6.2 Board Mounting	13

List of Figures

1	System Stack Diagram	4
2	Tyco Electronics 175785-1 (Reference Image Only)	6
3	Molex 22-12-4062 (Reference Image Only)	7
4	Tyco Electronics 43045-1601 (Reference Image Only)	8
5	Tyco Electronics 1452625-1 (Reference Image Only)	9
6	System Block Diagram	11
7	Dimension Drawing	13

List of Tables

1	Connector Information	6
2	Pin Description	6
3	Connector Information	7
4	Pin Description	7
5	Connector Information	8
6	Pin Description	8
7	Connector Information	9
8	Pin Description	9
9	Connections Between EVMs	11

Trademarks

LaunchPad, Code Composer Studio are trademarks of Texas Instruments. All other trademarks are the property of their respective owners.

1 EM1402 Evaluation Module

General Texas Instruments High Voltage Evaluation (TI HV EVM) User Safety Guidelines



WARNING

Warning: To minimize risk of fire hazard, always verify and follow any specific safety instructions and application considerations related to the batteries being used in conjunction with this EVM.

Always follow TI's set-up and application instructions, including use of all interface components within their recommended electrical rated voltage and power limits. Always use electrical safety precautions to help ensure your personal safety and the safety of those working around you. Contact TI's Product Information Center <http://support/ti.com> for further information.

Save all warnings and instructions for future reference.

Failure to follow warnings and instructions may result in personal injury, property damage, or death due to electrical shock and/or burn hazards.

The term TI HV EVM refers to an electronic device typically provided as an open framed, unenclosed printed-circuit-board assembly. It is intended strictly for use in development laboratory environments, solely for qualified professional users having training, expertise, and knowledge of electrical safety risks in development and application of high-voltage electrical circuits. Any other use or application are strictly prohibited by Texas Instruments. If you are not suitably qualified, you should immediately stop from further use of the HV EVM.

1. **Work Area Safety:**

1. Keep work area clean and orderly.
2. Qualified observer(s) must be present any time circuits are energized.
3. Effective barriers and signage must be present in the area where the TI HV EVM and its interface electronics are energized, indicating operation of accessible high voltages may be present, for the purpose of protecting inadvertent access.
4. All interface circuits, power supplies, evaluation modules, instruments, meters, scopes and other related apparatus used in a development environment exceeding 50 V_{RMS} or 75 VDC must be electrically located within a protected Emergency Power Off (EPO) protected power strip.
5. Use a stable and non-conductive work surface.
6. Use adequately insulated clamps and wires to attach measurement probes and instruments. No freehand testing whenever possible.

2. **Electrical Safety:** As a precautionary measure, it is always a good engineering practice to assume that the entire EVM may have fully accessible and active high voltages.

1. De-energize the TI HV EVM and all its inputs, outputs, and electrical loads before performing any electrical or other diagnostic measurements. Revalidate that TI HV EVM power has been safely de-energized.
2. With the EVM confirmed de-energized, proceed with required electrical circuit configurations, wiring, measurement equipment hook-ups and other application needs, while still assuming the EVM circuit and measuring instruments are electrically live.
3. Once EVM readiness is complete, energize the EVM as intended.

WARNING: while the EVM is energized, never touch the EVM or its electrical circuits as they could be at high voltages capable of causing electrical shock hazard.

3. Personal Safety:

1. Wear personal protective equipment, for example, latex gloves or safety glasses with side shields or protect EVM in an adequate lucent plastic box with interlocks from accidental touch.

4. Limitation for Safe Use:

1. EVMs are not to be used as all or part of a production unit.

2 General Description

The Texas Instruments *EM1402EVM Battery Management System* (BMS) is an evaluation board of the *Active Balance* chipset for use in large format Lithium-ion batteries that provides monitoring, balancing, and communications. With precise and robust active balancing, the *Active Balance* BMS is capable of bi-directional power transfer at each cell. Each EM1402EVM can manage 6 to 16 cells (70-V max) for Li-ion battery applications. The EM1402EVM modules can be stacked up to 1300 V. The system provides fast cell balancing, diagnostics, and module to controller communication. Independent protection circuitry is also provided.

The EM1402EVM is equipped with precision measurement and synchronous communication to enable a master controller to perform *State of Charge* (SOC) and *State of Health* (SOH) estimation. Highly accurate cell voltages and a fast sampling time for the entire battery pack allows more efficient operation of battery modules and more accurate SOC and SOH calculations. The user will be able to extend the available capacity of the battery and will benefit from longer pack lifetimes versus passive or dissipative balancing systems.

The EM1402EVM is equipped with smart diagnostic systems. These systems monitor fault events such as undervoltage, overvoltage, and overtemperature. The system is also capable of pack temperature and cell temperature sensing. The fault flagging systems help protect the battery module and alert the user of potential problems.

2.1 Key Features

This EVM includes the following features:

- Active bi-directional cell balancing
- Multi-cell charge and discharge capability
- Isolated communications (5 kV)
- Flexible architecture for up to 16 cells
- UART interface
- High accuracy cell voltage measurement
- Diagnostics

2.2 Key Electrical Parameters

The following table identifies the key electrical parameters:

Maximum battery pack voltage	1300 V
Maximum operating voltage	70 V
Minimum operating voltage	12 V
Maximum cell open circuit voltage	5V
Ambient temperature	-40 °C to 85 °C
Nominal operating temperature	-20 °C to 60 °C
Cell balancing current	up to +/- 5 A

3 Theory of Operation

Figure 1 shows the system stack diagram.

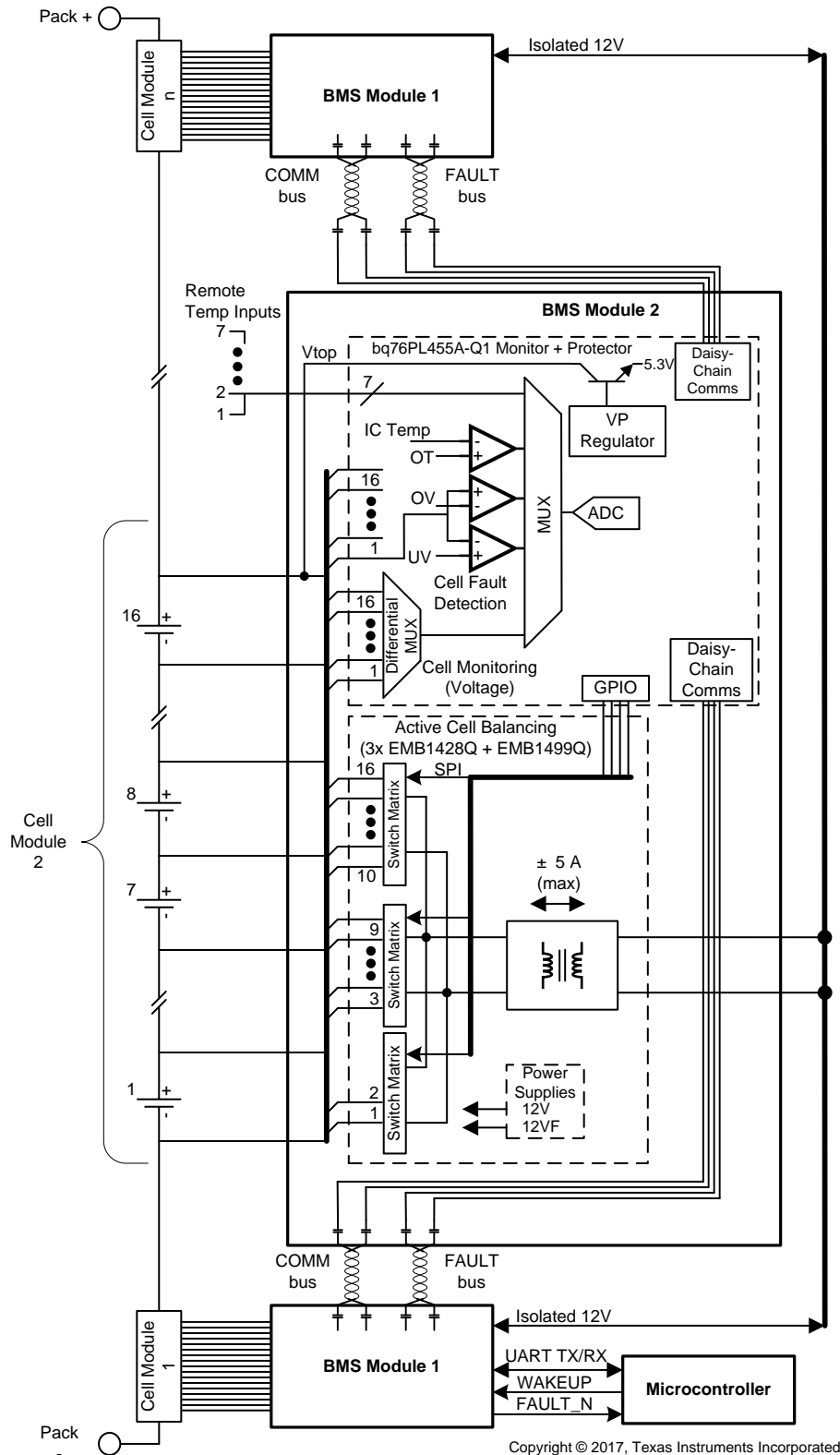

Figure 1. System Stack Diagram

The BMS system is designed to prolong the useful life of Lithium-ion cells in battery packs through active balancing. The battery pack is broken into a series of modules, each of which contains up to 16 cells. This system will monitor voltages of individual battery cells and transfer charge from the module stack to an under-charged cell or take charge from an over-charged cell and transfer it to the module stack. The BMS allows battery powered electric machines to use smaller battery packs and use fewer charging cycles to perform the same amount of work. It also improves the overall lifetime of Li-ion battery packs by preventing under- and overvoltage damage from occurring.

The BMS system has three main sub-systems, as shown in [Figure 1](#):

- Cell voltage monitoring circuitry
- Cell fault detection
- Active cell balancing engine

The cell-monitoring architecture is based on the bq76PL455A-Q1 (16 cell monitor and protection). Each EMB1428Q is designed to control access to up to 7 cells of a typical 16-cell battery module; the full 16-cell module utilizes three EMB1428Q and one to three EMB1499Q ICs. The EM1402EVM is designed with one EMB1499Q IC to allow simultaneous charge and discharge of a single cell (of the up to 16 cells attached) at up to 5 A.

All commands and data are communicated with a host via either a UART or daisy-chain communication connection. The EM1402 will not do anything without being first commanded from the host. The EM1402 can support a host PC or microcontroller (via the UART connection header) or a daisy-chain interface from a bq76PL455A-Q1 implemented as a communication bridge. The EMB1428Q is controlled via an SPI interface implemented on the bq76PL455A-Q1 GPIO.

The EM1402EVM has three EMB1428Q devices sharing control of a single EMB1499Q bi-directional DC-DC converter. The EM1402EVM has connected the cells the EMB1428Q devices as follows:

- EMB1428Q 1 (U2) : cells 1 and 2
- EMB1428Q 2 (U3) : cells 3 to 9
- EMB1428Q 3 (U4) : cells 10 to 16

The typical flow is for the host to go through the following sequence:

1. Wakeup the EM1402 board by sending a WAKEUP pulse when using the UART interface, or sending a WAKE tone when using the EM1402 in a stack of other EM1402 boards for a large battery pack or a bq76PL455A-Q1 configured as a bridge. Initialize the bq76PL455A-Q1 to be ready for use.
2. Send a sample command to the bq76PL455A-Q1 to read the cell measurement results.
3. The host will use the cell measurement data to calculate an average and determine the highest or lowest cells and determine the *one* cell that should be charged or discharged.
4. Send commands to the bq76PL455A-Q1 to initialize the EMB1428Q communication interface on the bq76PL455A-Q1 GPIO.
5. Send commands to the bq76PL455A-Q1 to initialize the SN74AHC595Q I/O expander to enable the chip select for the 8-bit DAC on the EM1402EVM.
6. Send commands to the bq76PL455A-Q1 to initialize the 8-bit DAC on the EM1402EVM which is used to set the charge or discharge current level (an input to EMB1499Q).
7. Send commands to the bq76PL455A-Q1 to initialize the SN74AHC595Q I/O expander to enable the chip select for the EMB1428Q connected to the target cell (determined in step 3).
8. Send commands to the bq76PL455A-Q1 to send the start command to the EMB1428Q to charge or discharge the target cell.
9. When charge or discharge is to be stopped, send commands to the bq76PL455A-Q1 to send the stop command to the EMB1428Q to stop the charge or discharge of the target cell.
 - If no stop command is sent, the EMB1499Q has a built-in timeout of 8 seconds, after which time the charge or discharge will be stopped automatically.
 - If a longer amount of charge or discharge time is needed, the host will need to send a stop command, followed by a start command at least every <8 seconds.
10. The host can then decide to repeat the process (back to step 2) or send commands to shutdown the EM1402EVM and return later.

3.1 Single Board

As a single board the BMS can actively balance up to 16 cells up to 70 V of total voltage. Communication to the EM1402EVM is handled by the daisy-chain communications bus from another bq76PL455A-Q1 or the UART host interface.

3.2 Stacked Systems

The BMS boards may be stacked up to 1300 V. Communication to the EM1402EVM is handled by the daisy-chain communications bus from another bq76PL455A-Q1.

4 Hardware Setup

4.1 Connectors

4.1.1 Battery Connector

The battery cell connections are made from connector J1. Cell voltage measurements and balancing currents use these connections. Short unused channels to the top cell connection in the wiring harness to support less than 16 cells.

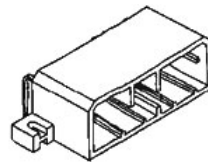

Figure 2. Tyco Electronics 175785-1 (Reference Image Only)

Table 1. Connector Information

Designator	Manufacturer	Part Number	Mating Connector
J1	Tyco Electronics	Manufacturer: 175785-1 Digi-Key: 175785-1-ND	Manufacturer: 174952-1 Digi-Key: 1-174952-1-ND Contacts: Manufacturer: 175027-6 (16-20 AWG) Digi-Key: 175027-6-ND

Table 2. Pin Description

		
Pin	Name	Comments
1	BAT16	Positive terminal of BAT16
2	BAT13	Positive terminal of BAT13, negative terminal of BAT14.
3	BAT12	Positive terminal of BAT12, negative terminal of BAT13.
4	BAT11	Positive terminal of BAT11, negative terminal of BAT12.
5	BAT10	Positive terminal of BAT10, negative terminal of BAT11.
6	BAT5	Positive terminal of BAT5, negative terminal of BAT6.
7	BAT4	Positive terminal of BAT4, negative terminal of BAT5.
8	BAT3	Positive terminal of BAT3, negative terminal of BAT4.
9	BAT0	Negative terminal of BAT1. Local ground for module.

Table 2. Pin Description (continued)

10	BAT15	Positive terminal of BAT16, negative terminal of BAT16.
11	BAT0	Negative terminal of BAT1. Local ground for module.
12	BAT14	Positive terminal of BAT14, negative terminal of BAT15.
13	NC	Not connected
14	BAT9	Positive terminal of BAT9, negative terminal of BAT10.
15	BAT8	Positive terminal of BAT8, negative terminal of BAT9.
16	BAT7	Positive terminal of BAT7, negative terminal of BAT8.
17	BAT6	Positive terminal of BAT6, negative terminal of BAT7.
18	BAT1	Positive terminal of BAT1, negative terminal of BAT2.
19	BAT16	Positive terminal of BAT16
20	BAT2	Positive terminal of BAT2, negative terminal of BAT3.

4.1.2 Host Interface

The 6-pin J3 - Serial connector is used to connect the bq76PL455EVM to a PC running the GUI or to a host controller. Signals at the J3 - Serial connector are 5-V TTL signals. Texas Instruments recommends using FTDI's USB-to-TTL serial converter cable to allow connection with a PC's USB port. The recommended cable is available from FTDI (<http://www.ftdichip.com>), and the appropriate part number for the 1.8-meter cable is TTL-232R-5V.

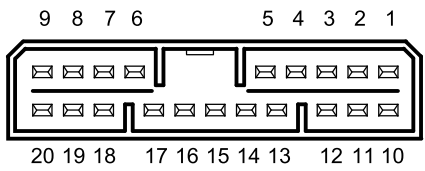
Figure 3. Molex 22-12-4062 (Reference Image Only)
Table 3. Connector Information

Designator	Manufacturer	Part Number	Mating Connector
J3	Molex	Manufacturer: 22-12-4062	Manufacturer: 22-01-2061 Digi-Key: WM1579-ND Contacts: Manufacturer: 08-55-0101 (22-30 AWG) Digi-Key: WM2312CT-ND

Table 4. Pin Description

Pin	Name	Mating Cable Color
1	Ground	Black
2	$\overline{\text{FAULT}}$ signal from bq76PL455A-Q1	Black
3	5-V input from PC	Red
4	RX from PC to bq76PL455A-Q1	Orange
5	TX from bq76PL455A-Q1 to PC	Yellow
6	$\overline{\text{WAKE}}$ signal from PC	Green

4.1.3 Thermistor Inputs

There are 7 thermistor connections. The board provides a 20-kΩ pullup to 3.3 V.

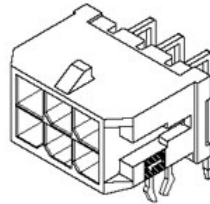
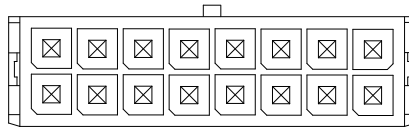

Figure 4. Tyco Electronics 43045-1601 (Reference Image Only)

Table 5. Connector Information

Designator	Manufacturer	Part Number	Mating Connector
TEMP_SENSE	Tyco Electronics	Manufacturer: 43045-1601	Manufacturer: 43025-1600 Digi-Key: WM2490-ND Contacts: Manufacturer: 43030-0012 (22-30 AWG) Digi-Key: WM2779CT-ND

Table 6. Pin Description



Pin	Name	Comments
1	GND	Ground
2	GND	Ground
3	GND	Ground
4	GND	Ground
5	GND	Ground
6	GND	Ground
7	GND	Ground
8	GND	Ground
9	AUX0	Thermistor 1 connection (on-board 20-kΩ pullup to 3.3 V)
10	AUX1	Thermistor 2 connection (on-board 20-kΩ pullup to 3.3 V)
11	AUX2	Thermistor 3 connection (on-board 20-kΩ pullup to 3.3 V)
12	AUX3	Thermistor 4 connection (on-board 20-kΩ pullup to 3.3 V)
13	AUX4	Thermistor 5 connection (on-board 20-kΩ pullup to 3.3 V)
14	AUX5	Thermistor 6 connection (on-board 20-kΩ pullup to 3.3 V)
15	AUX6	Thermistor 7 connection (on-board 20-kΩ pullup to 3.3 V)
16	NC	Not connected

4.1.4 External Isolated Balance Source

This connector provides the isolated supply that all EM1402EVM boards will balance cells to and from.

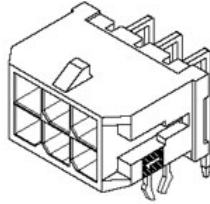

Figure 5. Tyco Electronics 1452625-1 (Reference Image Only)

Table 7. Connector Information

Designator	Manufacturer	Part Number	Mating connector
P2	Molex	Manufacturer: 43045-0222	Manufacturer: 43025-0200 Contacts: Manufacturer: 43030-0003 (20-24 AWG)

Table 8. Pin Description

Pin	Name	Comments
1	12V	Positive external isolated balance source input (shared with all other EM1402EVM modules, but isolated from all cells)
2	GND	GND of external isolated balance source input

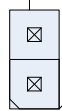

5 EM1402EVM Quick Start Guide

5.1 Before You Begin

The following warnings and cautions are noted for the safety of anyone using or working close to the bq76920 EVM. Observe all safety precautions.



Caution Do not leave EVM powered when unattended.



Danger High Voltage The EM1402EVM is not rated as a high voltage EVM, has smaller clearances than normally used on high voltage boards and does not have an isolation boundary. If you apply high voltage to this board, all terminals should be considered high voltage.

Electric shock is possible when connecting the board to live wire. The board should be handled with care by a professional.

For safety, use of isolated test equipment with overvoltage and overcurrent protection is highly recommended.

CAUTION

The circuit module has signal traces, components, and component leads on the bottom of the board. This may result in exposed voltages, hot surfaces, or sharp edges. Do not reach under the board during operation.

CAUTION

The circuit module may be damaged by overtemperature. To avoid damage, monitor the temperature during evaluation and provide cooling, as needed, for your system environment.

CAUTION

Some power supplies can be damaged by application of external voltages. If using more than 1 power supply, check your equipment requirements and use blocking diodes or other isolation techniques, as needed, to prevent damage to your equipment.

CAUTION

The communication interface is not isolated on the EVM. Be sure no ground potential exists between the computer and the EVM. Also be aware that the computer will be referenced to the Battery- potential of the EVM.

5.2 Hardware Setup

The system is implemented using the TMS570LS LaunchPad™ board (TMS570LS0432 MCU) and the EM1402EVM.

The part numbers of the evaluation modules are LAUNCHXL-TMS57004 and EM1402EVM. These boards are available from the TI eStore (<https://estore.ti.com/>) or from your local TI sales representative. For more details and information related to these evaluation modules (EVMs), see the specific EVM user's guide.

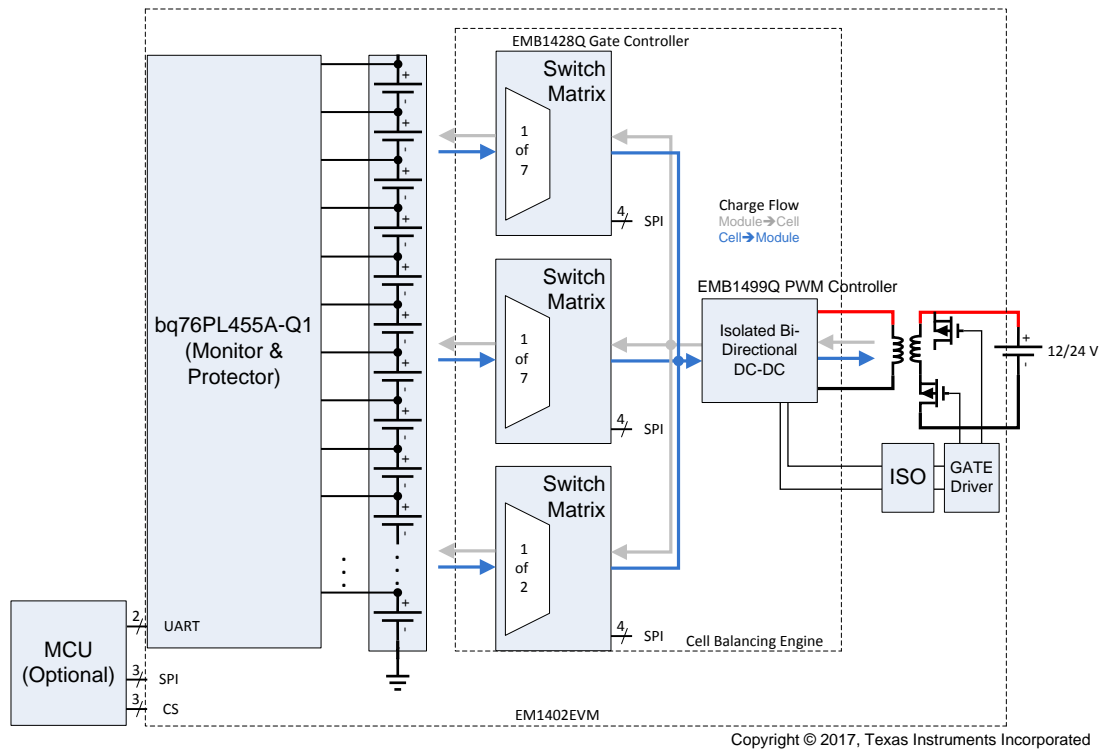

Figure 6. System Block Diagram

5.3 Connecting the Evaluation Modules

The EVMs are connected using a standard wire jumper; Figure 6 shows the connections between the two EVMs. By default, the TMS570 LaunchPad is powered by the USB port on the host computer and the EM1402EVM is powered by a 3.3-V regulator on the TMS570 LaunchPad board.

Table 9. Connections Between EVMs

Connection Name	EM1402EVM	TMS570 LaunchPad
TX	J3 pin 5	J1 pin 3 (SC11_RX)
RX	J3 pin 4	J1 pin 4 (SC11_TX)
nWAKE	J3 pin 6	J2 pin 3 (GIOA0)
nFAULT	J3 pin 2	J2 pin 4 (GIOA1)
VIO	J3 pin 3	J1 pin 1 (+3V3)
GND	J3 pin 1	J2 pin 1 (DGND)

5.4 Software

The software provides command API and drivers that implement the examples provided in *bq76PL455A-Q1 Software Design Reference* (SLVA617). There are comments in the source code that explain the section in the bq76PL455A-Q1 Software Design Reference document the example refers to.

The example code only provides a control interface to the bq76PL455A-Q1 and does not provide any other communications interface to the outside world. The customer is expected to develop their own communication implementation. Examples of communications interfaces available to the TMS570 are SPI, CAN, or UART.

This firmware provided with this application note provides source code examples of the command sequences described in the *bq76PL455A-Q1 Software Design Reference* (SLVA617).

Download sample application code and other information associated with this application report from [tidcci7](#).

Importing a project into *Code Composer Studio*™

1. Launch the provided file: *EM1402EVM Example Code 0.1 Installer.exe* and extract files to the default path provided (C:\ti\EM1402EVM Example Code 0.1).
2. Launch *Code Composer Studio* (CCS):
Start → **Programs** → **Texas Instruments** → **Code Composer Studio v7** → **Code Composer Studio v7**
3. When it launches, CCS requests a workspace is selected, choose "C:\myWorkspace". Once CCS loads, go to:
File → **Import** → **Code Composer Studio** → **Existing CCS Eclipse Projects**
4. In Select search-directory, browse to the folder:
C:\ti\EM1402EVM Example Code 0.1
5. In Discovered projects: Check EM1402EVM Example Code

6 Physical Dimensions

6.1 Board Dimensions

Board dimensions: 5.5 in x 3.75 in

Board height:

- Top - Tallest component (Battery Connector) is 0.64 in (16.3 mm) above PCB.
- Bottom - Tallest component (cell input RC filter cap) is 0.054 in (1.4 mm) above PCB.

6.2 Board Mounting

Figure 7 illustrates the EVM dimension drawing.

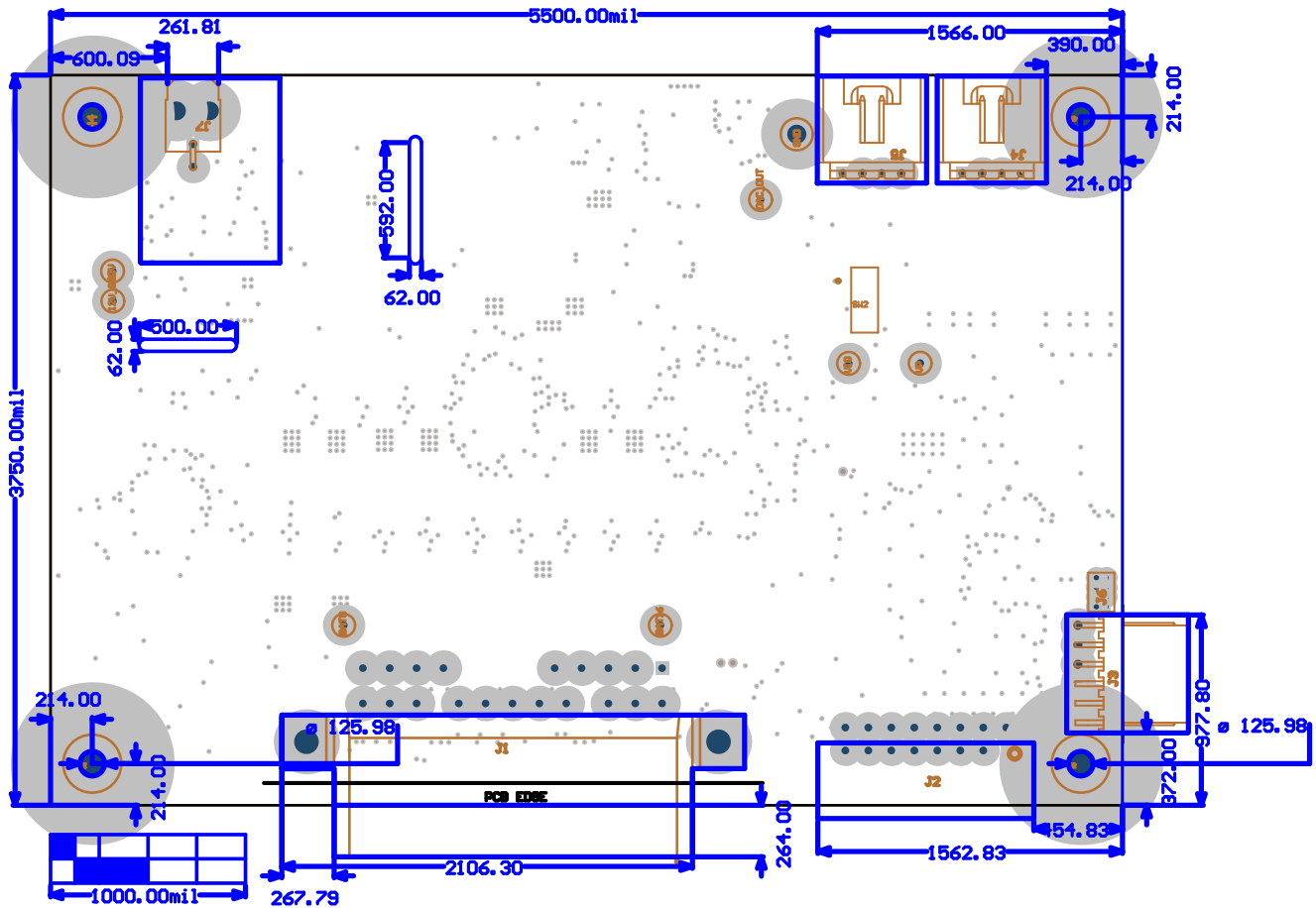

Figure 7. Dimension Drawing

IMPORTANT NOTICE FOR TI DESIGN INFORMATION AND RESOURCES

Texas Instruments Incorporated ("TI") technical, application or other design advice, services or information, including, but not limited to, reference designs and materials relating to evaluation modules, (collectively, "TI Resources") are intended to assist designers who are developing applications that incorporate TI products; by downloading, accessing or using any particular TI Resource in any way, you (individually or, if you are acting on behalf of a company, your company) agree to use it solely for this purpose and subject to the terms of this Notice.

TI's provision of TI Resources does not expand or otherwise alter TI's applicable published warranties or warranty disclaimers for TI products, and no additional obligations or liabilities arise from TI providing such TI Resources. TI reserves the right to make corrections, enhancements, improvements and other changes to its TI Resources.

You understand and agree that you remain responsible for using your independent analysis, evaluation and judgment in designing your applications and that you have full and exclusive responsibility to assure the safety of your applications and compliance of your applications (and of all TI products used in or for your applications) with all applicable regulations, laws and other applicable requirements. You represent that, with respect to your applications, you have all the necessary expertise to create and implement safeguards that (1) anticipate dangerous consequences of failures, (2) monitor failures and their consequences, and (3) lessen the likelihood of failures that might cause harm and take appropriate actions. You agree that prior to using or distributing any applications that include TI products, you will thoroughly test such applications and the functionality of such TI products as used in such applications. TI has not conducted any testing other than that specifically described in the published documentation for a particular TI Resource.

You are authorized to use, copy and modify any individual TI Resource only in connection with the development of applications that include the TI product(s) identified in such TI Resource. NO OTHER LICENSE, EXPRESS OR IMPLIED, BY ESTOPPEL OR OTHERWISE TO ANY OTHER TI INTELLECTUAL PROPERTY RIGHT, AND NO LICENSE TO ANY TECHNOLOGY OR INTELLECTUAL PROPERTY RIGHT OF TI OR ANY THIRD PARTY IS GRANTED HEREIN, including but not limited to any patent right, copyright, mask work right, or other intellectual property right relating to any combination, machine, or process in which TI products or services are used. Information regarding or referencing third-party products or services does not constitute a license to use such products or services, or a warranty or endorsement thereof. Use of TI Resources may require a license from a third party under the patents or other intellectual property of the third party, or a license from TI under the patents or other intellectual property of TI.

TI RESOURCES ARE PROVIDED "AS IS" AND WITH ALL FAULTS. TI DISCLAIMS ALL OTHER WARRANTIES OR REPRESENTATIONS, EXPRESS OR IMPLIED, REGARDING TI RESOURCES OR USE THEREOF, INCLUDING BUT NOT LIMITED TO ACCURACY OR COMPLETENESS, TITLE, ANY EPIDEMIC FAILURE WARRANTY AND ANY IMPLIED WARRANTIES OF MERCHANTABILITY, FITNESS FOR A PARTICULAR PURPOSE, AND NON-INFRINGEMENT OF ANY THIRD PARTY INTELLECTUAL PROPERTY RIGHTS.

TI SHALL NOT BE LIABLE FOR AND SHALL NOT DEFEND OR INDEMNIFY YOU AGAINST ANY CLAIM, INCLUDING BUT NOT LIMITED TO ANY INFRINGEMENT CLAIM THAT RELATES TO OR IS BASED ON ANY COMBINATION OF PRODUCTS EVEN IF DESCRIBED IN TI RESOURCES OR OTHERWISE. IN NO EVENT SHALL TI BE LIABLE FOR ANY ACTUAL, DIRECT, SPECIAL, COLLATERAL, INDIRECT, PUNITIVE, INCIDENTAL, CONSEQUENTIAL OR EXEMPLARY DAMAGES IN CONNECTION WITH OR ARISING OUT OF TI RESOURCES OR USE THEREOF, AND REGARDLESS OF WHETHER TI HAS BEEN ADVISED OF THE POSSIBILITY OF SUCH DAMAGES.

You agree to fully indemnify TI and its representatives against any damages, costs, losses, and/or liabilities arising out of your non-compliance with the terms and provisions of this Notice.

This Notice applies to TI Resources. Additional terms apply to the use and purchase of certain types of materials, TI products and services. These include; without limitation, TI's standard terms for semiconductor products (<http://www.ti.com/sc/docs/stdterms.htm>), [evaluation modules](#), and [samples](http://www.ti.com/sc/docs/sampterm.htm) (<http://www.ti.com/sc/docs/sampterm.htm>).

Mailing Address: Texas Instruments, Post Office Box 655303, Dallas, Texas 75265
Copyright © 2018, Texas Instruments Incorporated