

# Using the CC1200 Under ARIB STD T108

Torstein Ermesjø

## ABSTRACT

This application report outlines the expected performance when operating CC1200 under ARIB T108 in the 920 MHz frequency band. It is assumed that you are familiar with CC1200 and ARIB T108 regulatory limits. Lab measurements show that CC1200 meets ARIB T108 requirements.

Project collateral and source code discussed in this document can be downloaded from the following URL: <http://www.ti.com/lit/zip/swra445>.

## Contents

|            |   |    |
|------------|---|----|
| 1          | Introduction .....                                | 2  |
| 2          | Overview of ARIB STD T108.....                    | 3  |
| 3          | TX Conducted Measurements: CC1200EM 868-930 ..... | 8  |
| 4          | RX Conducted Measurements: CC1200EM 868-930 ..... | 19 |
| 5          | RX Conducted Measurements: CC1200EM 920.....      | 29 |
| 6          | TX Conducted Measurements: CC1200 920 IPC.....    | 30 |
| 7          | RX Conducted Measurements: CC1200EM 920 IPC ..... | 39 |
| 8          | References .....                                  | 40 |
| Appendix A | EM Schematics .....                               | 41 |

## List of Figures

|    |  |    |
|----|--|----|
| 1  | Detector: Max Hold .....                           | 7  |
| 2  | Detector: RMS.....                                 | 7  |
| 3  | Channel Plan for 920 MHz Band Radio Equipment..... | 8  |
| 4  | Spurious Emission 40 MHz - 710 MHz .....           | 11 |
| 5  | Spurious Emission 710 MHz - 900 MHz .....          | 12 |
| 6  | Spurious Emission 900 MHz - 915 MHz .....          | 13 |
| 7  | Spurious Emission 915 MHz - 920.4 MHz .....        | 14 |
| 8  | Spurious Emission 920.8 MHz - 930 MHz .....        | 15 |
| 9  | Spurious Emission 930 MHz - 1000 MHz .....         | 16 |
| 10 | Spurious Emission 1000 MHz - 1215 MHz .....        | 17 |
| 11 | Spurious Emission Above 1215 MHz.....              | 18 |
| 12 | Spurious Emission 40 MHz - 710 MHz .....           | 22 |
| 13 | Spurious Emission 710 MHz - 900 MHz .....          | 23 |
| 14 | Spurious Emission 900 MHz - 915 MHz .....          | 24 |
| 15 | Spurious Emission 915 MHz - 920.4 MHz .....        | 25 |
| 16 | Spurious Emission 920.8 MHz - 930 MHz .....        | 26 |
| 17 | Spurious Emission 930 MHz - 1000 MHz.....          | 27 |
| 18 | Spurious Emission 1000 MHz - 1215 MHz .....        | 28 |
| 19 | Spurious Emission Above 1215 MHz.....              | 29 |
| 20 | Spurious Emission 40 MHz - 710 MHz .....           | 32 |
| 21 | Spurious Emission 710 MHz - 900 MHz .....          | 33 |

All trademarks are the property of their respective owners.

|    |   |    |
|----|---|----|
| 22 | Spurious Emission 900 MHz - 915 MHz .....   | 34 |
| 23 | Spurious Emission 915 MHz - 920.4 MHz ..... | 35 |
| 24 | Spurious Emission 920.8 MHz - 930 MHz ..... | 36 |
| 25 | Spurious Emission 930 MHz - 1000 MHz .....  | 37 |
| 26 | Spurious Emission 1000 MHz - 1215 MHz ..... | 38 |
| 27 | Spurious Emission Above 1215 MHz .....      | 39 |

### List of Tables

|    |  |    |
|----|--|----|
| 1  | TX Summary CC1200EM 868 930 .....  | 3  |
| 2  | TX Summary CC1200EM 920 .....  | 3  |
| 3  | TX Summary CC1200EM 920 .....  | 3  |
| 4  | Key Parameters and Functionality .....                                   | 4  |
| 5  | Permissible Values for Unwanted Emission Intensity (antenna input) ..... | 4  |
| 6  | Limit on Secondary Radiated Emissions, and so forth at Receiver .....    | 4  |
| 7  | Key Parameters and Functionality .....                                   | 5  |
| 8  | Unit Channel Bandwidth .....   | 5  |
| 9  | Permissible Values for Unwanted Emission Intensity (antenna input) ..... | 6  |
| 10 | Limit on Secondary Radiated Emissions, and so Forth at Receiver .....    | 6  |
| 11 | Output Power +13 dBm .....   | 9  |
| 12 | Output Power 0 dBm .....   | 9  |
| 13 | ACP Mask 1 Results .....   | 10 |
| 14 | ACP Mask 2 Results .....   | 10 |
| 15 | ACP Mask 3 Results .....   | 10 |
| 16 | ACP Mask 4 Results .....   | 11 |
| 17 | Sensitivity .....  | 19 |
| 18 | Output Power +13 dBm .....   | 19 |
| 19 | Output Power 0 dBm .....   | 19 |
| 20 | ACP Mask 1 Results .....   | 20 |
| 21 | ACP Mask 2 Results .....   | 20 |
| 22 | ACP Mask 3 Results .....   | 21 |
| 23 | ACP Mask 4 Results .....   | 21 |
| 24 | Sensitivity .....  | 29 |
| 25 | Output Power +13 dBm .....   | 30 |
| 26 | Output Power 0 dBm .....   | 30 |
| 27 | ACP Mask 1 Results .....   | 31 |
| 28 | ACP Mask 2 Results .....   | 31 |
| 29 | ACP Mask 3 Results .....   | 31 |
| 30 | ACP Mask 3 Results .....   | 32 |
| 31 | Sensitivity .....  | 39 |
| 32 | CC1200 EM Rev 1.2.2 920 MHz IPC .....                                    | 43 |

## 1 Introduction

Three different evaluation modules (EM) are used in this document:

- CC1200EM 868-930: <http://www.ti.com/tool/cc1200emk-868-930>
- CC1200 920: An extension of the 868-930 EM where extra bandpass filtering is added around 800 MHz
- CC1200 IPC 920: Murata has developed an IPC for the 920 MHz T-108 band with extra bandpass filtering integrated

**Table 1. TX Summary CC1200EM 868 930**

| Frequency                 | Measured [dBm] | Specification [dBm] | Margin [dBm] |
|---------------------------|----------------|---------------------|--------------|
| f <= 710 MHz              | -57            | -36                 | 21           |
| 710 MHz < f <= 900 MHz    | -57            | -55                 | 2            |
| 900 MHz < f <= 915 MHz    | -57            | -55                 | 2            |
| 915 MHz < f <= 930 MHz    | -39            | -36                 | 3            |
| 930 MHz < f <= 1000 MHz   | -58            | -55                 | 3            |
| 1000 MHz < f <= 1,215 MHz | -58            | -45                 | 13           |
| 1,215 MHz < f             | -40            | -30                 | 10           |

**Table 2. TX Summary CC1200EM 920**

| Frequency                 | Measured [dBm] | Specification [dBm] | Margin [dBm] |
|---------------------------|----------------|---------------------|--------------|
| f <= 710 MHz              | -61            | -36                 | 25           |
| 710 MHz < f <= 900 MHz    | -57            | -55                 | 2            |
| 900 MHz < f <= 915 MHz    | -57            | -55                 | 2            |
| 915 MHz < f <= 930 MHz    | -38            | -36                 | 2            |
| 930 MHz < f <= 1000 MHz   | -57            | -55                 | 2            |
| 1000 MHz < f <= 1,215 MHz | -45            | -45                 | 10           |
| 1,215 MHz < f             | -40            | -30                 | 10           |

**Table 3. TX Summary CC1200EM 920**

| Frequency                 | Measured [dBm] | Specification [dBm] | Margin [dBm] |
|---------------------------|----------------|---------------------|--------------|
| f <= 710 MHz              | -58            | -36                 | 22           |
| 710 MHz < f <= 900 MHz    | -57            | -55                 | 2            |
| 900 MHz < f <= 915 MHz    | -57            | -55                 | 2            |
| 915 MHz < f <= 930 MHz    | -40            | -36                 | 4            |
| 930 MHz < f <= 1000 MHz   | -57            | -55                 | 2            |
| 1000 MHz < f <= 1,215 MHz | -58            | -45                 | 13           |
| 1,215 MHz < f             | -33            | -30                 | 3            |

## 2 Overview of ARIB STD T108

The radio equipment defined in this standard utilizes the frequency band from 915 MHz to 930 MHz. The ARIB STD-T108 defines two different types of possible categories of application:

- Convenience Radio Stations
- Low-Power Radio Stations

The main differences between the possible categories are output power and which band frequency is used. The following sections give a short description of the two categories.

## 2.1 Convenience Radio Stations

The contents of communication are primarily the signals for telemetry, telecontrol and data transmission system. The key parameters are listed in [Table 4](#).

**Table 4. Key Parameters and Functionality**

| Item                |                   | Parameters and Functionality   |
|---------------------|-------------------|--|
| Frequency Band      |                   | 920.5 MHz - 923.5 MHz  |
| Transmission Power  |                   | <250 mW  |
| Transmission Method | Contents          | Data Signal  |
|                     | Modulation System | Not specified  |
| Antenna Gain        |                   | 3 dBi or less (absolute gain). However, in case EIRP is less than the value of 3 dBi plus 250 mW of antenna power, it is allowed to fill in the gap by the antenna gain. |

A radio channel consists of up to five consecutive unit radio channels with center frequency between 920.6 MHz and 923.4 MHz, with 200 kHz separation and 200 kHz bandwidth. The permitted occupied bandwidth is (200xn) kHz or less where *n* is the number of unit radio channels. The frequency tolerance should be within 20 ppm.

Two masks are defined for adjacent channel power: one for the 920.5 MHz – 922.3 MHz band and one for 922.3 MHz - 923.5 MHz band.

[Table 5](#) describes permitted unwanted emissions.

**Table 5. Permissible Values for Unwanted Emission Intensity (antenna input)**

| Frequency Band  | Spurious Emission Strength (average power) | Reference Bandwidth |
|---|--|---------------------|
| $f \leq 710$ MHz  | -36 dBm                                    | 100 kHz             |
| 710 MHz < $f \leq 900$ MHz  | -55 dBm                                    | 1 MHz               |
| 900 MHz < $f \leq 915$ MHz  | -55 dBm                                    | 100 kHz             |
| 915 MHz < $f \leq 920.3$ MHz  | -36 dBm                                    | 100 kHz             |
| 920.3 MHz < $f \leq 924.3$ MHz<br>(except for $ f-f_c  \leq (200+100x)n$ kHz) | -55 dBm                                    | 100 kHz             |
| 924.3 MHz < $f \leq 930$ MHz  | -36 dBm                                    | 100 kHz             |
| 930 MHz < $f \leq 1000$ MHz   | -55 dBm                                    | 100 kHz             |
| 1000MHz < $f \leq 1,215$ MHz  | -45 dBm                                    | 1 MHz               |
| 1,215 MHz < $f$   | -30 dBm                                    | 1 MHz               |

[Table 6](#) describes secondary radiated emission limits.

**Table 6. Limit on Secondary Radiated Emissions, and so forth at Receiver**

| Frequency Band              | Limit on Secondary Radiated Emissions, and so Forth (antenna input) | Reference Bandwidth |
|-----------------------------|---|---------------------|
| $f \leq 710$ MHz            | -54 dBm   | 100 kHz             |
| 710 MHz < $f \leq 900$ MHz  | -55 dBm   | 1 MHz               |
| 900 MHz < $f \leq 915$ MHz  | -55 dBm   | 100 kHz             |
| 915 MHz < $f \leq 930$ MHz  | -54 dBm   | 100 kHz             |
| 930 MHz < $f \leq 1000$ MHz | -55 dBm   | 100 kHz             |
| 1000 MHz < $f$              | -47 dBm   | 1 MHz               |

## 2.2 Low-Power Radio Stations

The contents of communication are primarily the signals for telemetry, telecontrol and data transmission system. The key parameters are listed in [Table 7](#).

**Table 7. Key Parameters and Functionality**

| Item                |                   | Parameters and Functionality  |
|---------------------|-------------------|---|
| Frequency Band      |                   | 915.9 MHz - 916.9 MHz<br>920.5 MHz - 929.7 MHz  |
| Transmission Power  |                   | <20 mW (13 dBm) for 920.5 MHz - 928.15 MHz<br><1 mW (0 dBm) for 916.0 MHz - 916.8 MHz and 928.15 MHz - 929.65 MHz   |
| Transmission Method | Contents          | Data Signal   |
|                     | Modulation System | Not specified   |
| Antenna Gain        |                   | 3 dBi or less (absolute gain). However, in case EIRP is less than the value of 3 dBi plus 1 mW or 20 mW of antenna power, it is allowed to fill in the gap by the antenna gain. |

A radio channel consists of up to five consecutive unit radio channels. A unit channel is 100 kHz or 200 kHz wide depending on the frequency band.

**Table 8. Unit Channel Bandwidth**

| Center Frequency      | Unit Channel Separation/Bandwidth |
|-----------------------|-----------------------------------|
| 916.0 MHz-916.8 MHz   | 200 kHz                           |
| 920.6 MHz-928.0 MHz   | 200 kHz                           |
| 928.15 MHz-929.65 MHz | 100 kHz                           |

The permitted occupied bandwidth is  $(200 \times n)$  kHz or less where  $n$  is the number of unit radio channels except for when the center frequency is from 928.15 MHz to 929.65 MHz where the maximum bandwidth is  $(100 \times n)$  kHz. The frequency tolerance should be within 20 ppm.

For adjacent channel power five masks are defined:

- From 915.9 MHz to 916.9 MHz
- From 920.5 MHz to 922.3 MHz
- From 922.3 MHz to 928.1 MHz (For transmission power <0 dBm)
- From 922.3 MHz to 928.1 MHz (For transmission power between 0 dBm and 13 dBm)
- From 928.1 MHz to 929.7 MHz

Table 9 describes permitted unwanted emissions.

**Table 9. Permissible Values for Unwanted Emission Intensity (antenna input)**

| Frequency Band   | Spurious Emission Strength (average power) | Reference Bandwidth |
|--|--|---------------------|
| $f \leq 710$ MHz   | -36 dBm                                    | 100 kHz             |
| 710 MHz < $f \leq 900$ MHz   | -55 dBm                                    | 1 MHz               |
| 900 MHz < $f \leq 915$ MHz   | -55 dBm                                    | 100 kHz             |
| 915 MHz < $f \leq 930$ MHz*<br>(Except for $ f-f_c  \leq (200 + 100 \times n)$ kHz if bandwidth of unit radio channel is 200 kHz, except for $ f-f_c  \leq (100 + 50 \times n)$ kHz if bandwidth of unit radio channel is 100 kHz.<br>Except for $ f-f_c  \leq (100 + 100 \times n)$ kHz if frequency band is 915.9 MHz <= $f \leq 916.9$ MHz and 920.5 MHz <= 922.3 MHz. Where $n$ is a number of unit radio channels constituting the radio channel and is an integer from 1 to 5) | -36 dBm                                    | 100 kHz             |
| 930 MHz < $f \leq 1000$ MHz  | -55 dBm                                    | 100 kHz             |
| 1000 MHz < $f \leq 1,215$ MHz  | -45 dBm                                    | 1 MHz               |
| 1,215 MHz < $f$  | -30 dBm                                    | 1 MHz               |

Table 10 describes secondary radiated emission limits.

**Table 10. Limit on Secondary Radiated Emissions, and so Forth at Receiver**

| Frequency Band              | Limit on Secondary Radiated Emissions, and so Forth (antenna input) | Reference Bandwidth |
|-----------------------------|---|---------------------|
| $f \leq 710$ MHz            | -54 dBm   | 100 kHz             |
| 710 MHz < $f \leq 900$ MHz  | -55 dBm   | 1 MHz               |
| 900 MHz < $f \leq 915$ MHz  | -55 dBm   | 100 kHz             |
| 915 MHz < $f \leq 930$ MHz  | -54 dBm   | 100 kHz             |
| 930 MHz < $f \leq 1000$ MHz | -55 dBm   | 100 kHz             |
| 1000 MHz < $f$              | -47 dBm   | 1 MHz               |

### 2.3 Spectrum Analyzer Setup

Section 2.4 under “Test Item: The intensity of Spurious Emission or unwanted emission” in TELEC-T245 outlines the procedure of the measurement operation. First, a sweep using max hold should be performed with the RBW setting defined for the defined frequency ranges. If the measured amplitude is above the limit 0 Hz span has to be used and a single sweep should be performed for all frequencies that exceed the standard value to find the average value of the spurious emission. Using a spectrum analyzer, this is equivalent to using the rms detector. Figure 1 and Figure 2 show the difference between using max hold and rms.

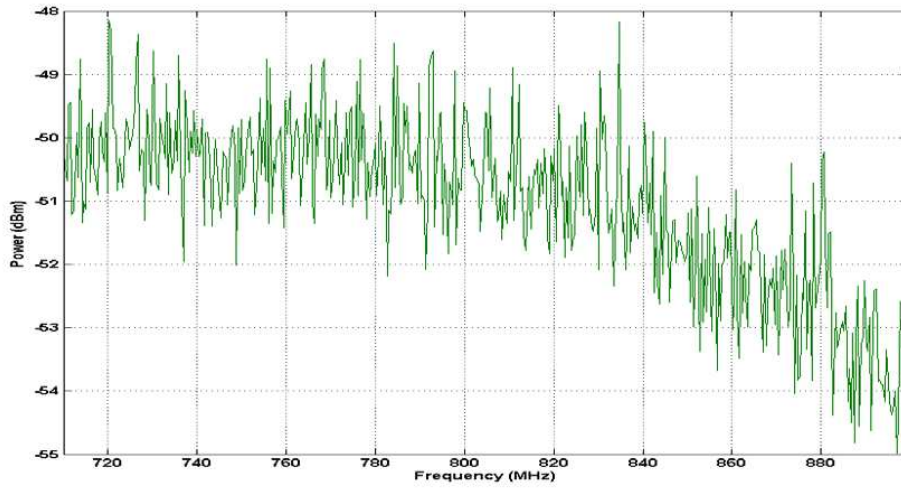

**Figure 1. Detector: Max Hold**

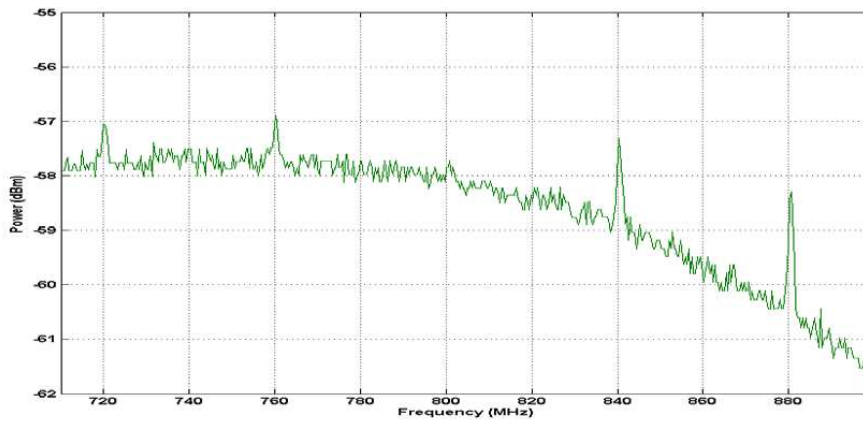

**Figure 2. Detector: RMS**

## 2.4 Channel Plan for 920 MHz Band Radio Equipment

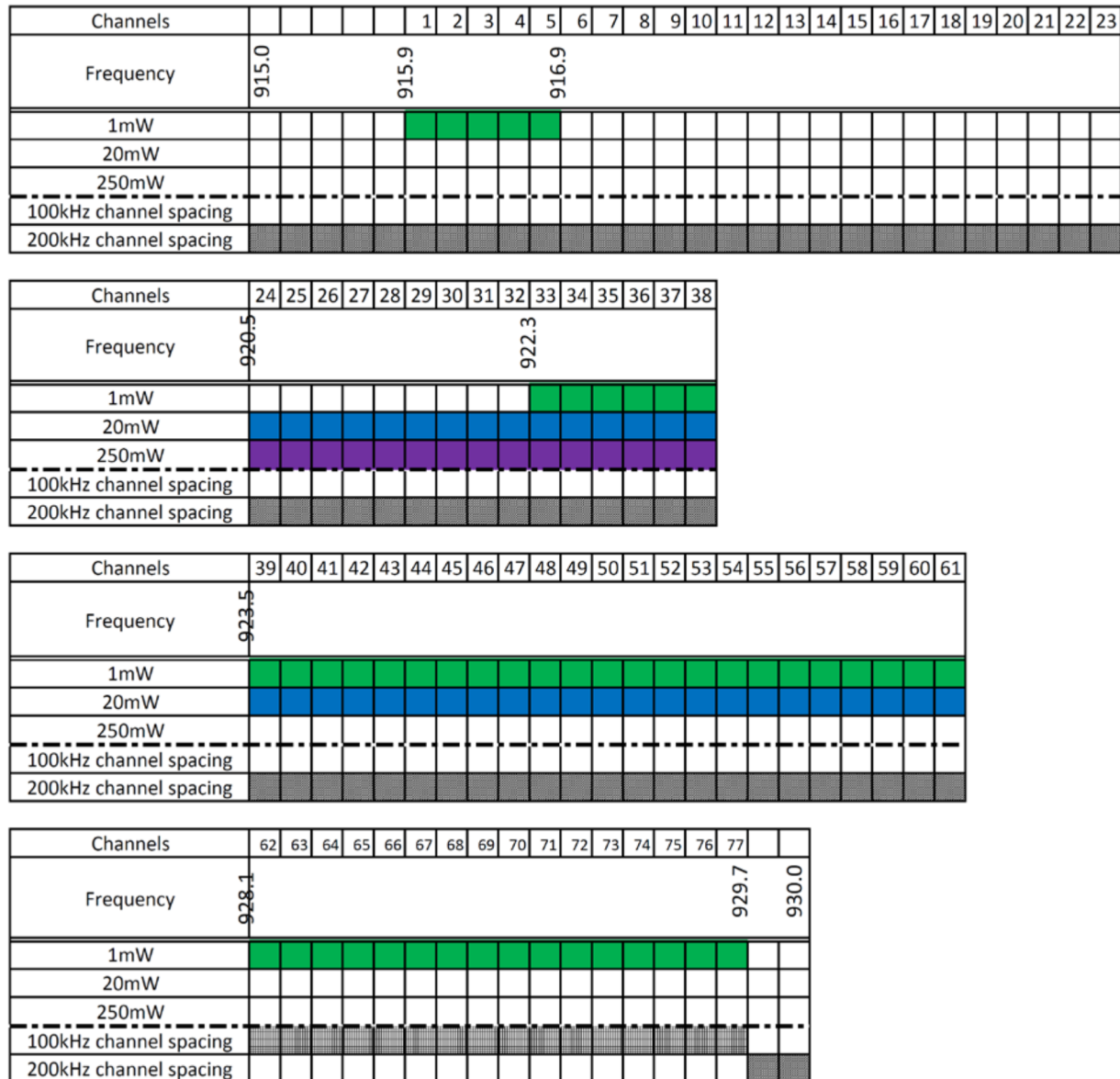

Figure 3. Channel Plan for 920 MHz Band Radio Equipment

### 3 TX Conducted Measurements: CC1200EM 868-930

The TX conducted measurements are measured according to the “low-power radio station” standard referenced in [Section 2.2](#).

#### 3.1 Output Power

Dependent on frequency band the maximum output power is 1 mW (0 dBm) or 20 mW (+13 dBm). To achieve +13 dBm with this evaluation module the bias current in the PA is increased by setting PA\_CFG3 = 0x02.



**Table 11. Output Power +13 dBm**

| Setting [PA_CFG1] | Output Power [dBm] |
|-------------------|--------------------|
| F                 | 14.0               |
| 7E                | 13.8               |
| 7D                | 13.4               |
| 7C                | 13.1               |
| 7B                | 12.8               |

For 0 dBm, nominal PA bias current is used.

**Table 12. Output Power 0 dBm**

| Setting [PA_CFG1] | Output Power [dBm] |
|-------------------|--------------------|
| 68                | 0.9                |
| 67                | 0.4                |
| 66                | 0                  |
| 65                | -0.6               |
| 64                | -1.0               |

The following register settings are used for the measurements in this section:

- +13 dBm
  - PA\_CFG1 = 0x7C
  - PA\_CFG3 = 0x02
  - FS\_DIG1 = 0x04
  - FS\_DIG0 = 0x55
- 0 dBm
  - PA\_CFG1 = 0x66

### 3.2 Occupied Bandwidth (OBW)

The permitted occupied bandwidth is defined as 99% of the power within  $n \times$  Unit Channel bandwidth where the Unit Channel Bandwidth is 100 kHz or 200 kHz depending on the sub frequency band and  $n$  is the number of Unity Channels. The OBW is dependent on the modulation.

- 50 kbps, 25 kHz deviation (2GFSK): OBW = 83 kHz
- 100 kbps, 50 kHz deviation (2GFSK): OBW = 171 kHz

### 3.3 ACP

The Adjacent Channel leakage power requirements are divided into four different masks dependent on the frequency. The measurements are done with the stated data rate and unit channels:

- 50 kbps, 25 kHz deviation (2GFSK)
- 100 kbps, 50 kHz deviation (2GFSK)

### 3.3.1 ACP Mask 1

**Table 13. ACP Mask 1 Results**

| Frequency                  | 915.9 MHz – 916.8 MHz. Max 0 dBm |                |                            |
|----------------------------|----------------------------------|----------------|----------------------------|
| Specification              | Required [dBm]                   | Measured [dBm] |                            |
| <b>Power @channel edge</b> | -20                              | -40            | @50 kbps, unit ch num 1    |
|                            |                                  | -12            | @100 kbps, unit ch num 1   |
|                            |                                  | -43            | @100 kbps, unit ch num 1,2 |
| <b>ACP</b>                 | <-26                             | -49            | @50 kbps, unit ch num 1    |
|                            |                                  | -29            | @100 kbps, unit ch num 1   |
|                            |                                  | -50            | @100 kbps, unit ch num 1,2 |

To comply with the power at the channel edge, requirement 2 unit channels have to be used if the data rate is 100 kbps.

### 3.3.2 ACP Mask 2

**Table 14. ACP Mask 2 Results**

| Frequency                  | 920.5 MHz – 922.3 MHz. Max +13 dBm |                |                              |
|----------------------------|------------------------------------|----------------|------------------------------|
| Specification              | Required [dBm]                     | Measured [dBm] |                              |
| <b>Power @channel edge</b> | -7                                 | -30            | @50 kbps, unit ch num 24     |
|                            |                                    | -4             | @100 kbps, unit ch num 24    |
|                            |                                    | -31            | @100 kbps, unit ch num 24,25 |
| <b>ACP</b>                 | <-15                               | -36            | @50 kbps, unit ch num 24     |
|                            |                                    | -17            | @100 kbps, unit ch num 24    |
|                            |                                    | -39            | @100 kbps, unit ch num 24,25 |

The ACP limit changes to < -26 dBm if the output power is less than 0 dBm. The ACP mask 2 measurements were performed using +13 dBm output power in this application report.

To comply with the power at the channel edge requirement 2 unit channels have to be used if the data rate is 100 kbps.

### 3.3.3 ACP Mask 3

**Table 15. ACP Mask 3 Results**

| Frequency                            | 922.3 MHz – 928.1 MHz |                |                              |
|--------------------------------------|-----------------------|----------------|------------------------------|
| Specification                        | Required [dBm]        | Measured [dBm] |                              |
| <b>ACP (output power &lt; 0 dBm)</b> | <-26                  | -49            | @50 kbps, unit ch num 33     |
|                                      |                       | -29            | @100 kbps, unit ch num 33    |
|                                      |                       | -49            | @100 kbps, unit ch num 33,34 |
| <b>ACP 13 dBm)</b>                   | <-15                  | -36            | @50 kbps, unit ch num 33     |
|                                      |                       | -16            | @100 kbps, unit ch num 33    |
|                                      |                       | -49            | @100 kbps, unit ch num 33,34 |

**3.3.4 ACP Mask 4**

**Table 16. ACP Mask 4 Results**

|                      |                                  |                |  |
|----------------------|----------------------------------|----------------|--|
| <b>Frequency</b>     | 928.1 MHz – 929.7 MHz. Max 0 dBm |                |  |
| <b>Specification</b> | Required [dBm]                   | Measured [dBm] |  |
| <b>ACP</b>           | <-26                             | -30<br>-49     | @50 kbps, unit ch num 62<br>@100 kbps, unit ch num 62,63 |

**3.4 Unwanted Emission Intensity**

The allowed levels for spurious emissions are described in [Table 9](#).

**3.4.1 Spurious Emission 40 MHz – 710 MHz**

The allowed level of spurious emissions within the 40 MHz -710 MHz frequency band is specified as less than -36 dBm in any 100 kHz bandwidth. The channel center frequency selected for this measurement is 920.6 MHz. The measured spurious emissions within this frequency band are shown in [Figure 4](#).

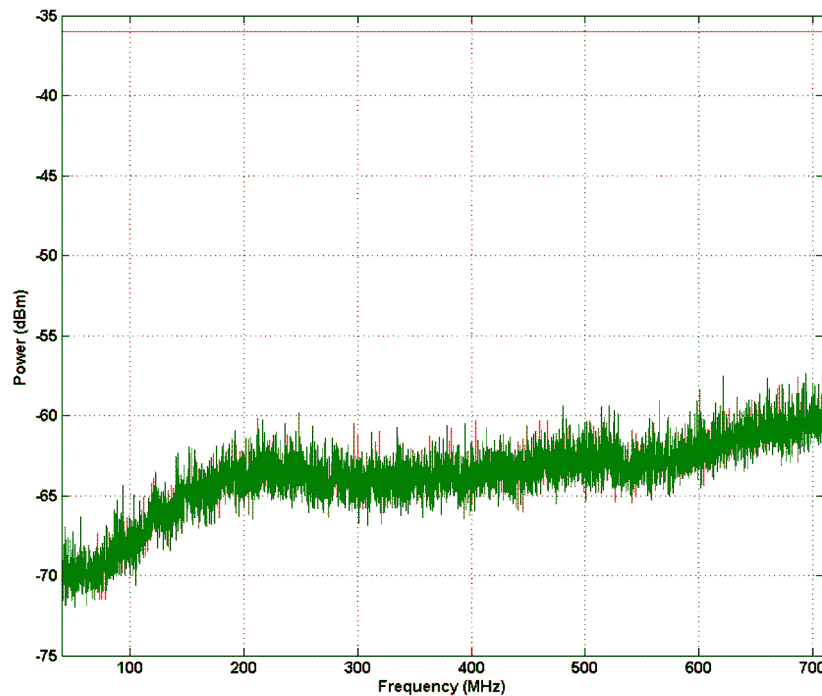
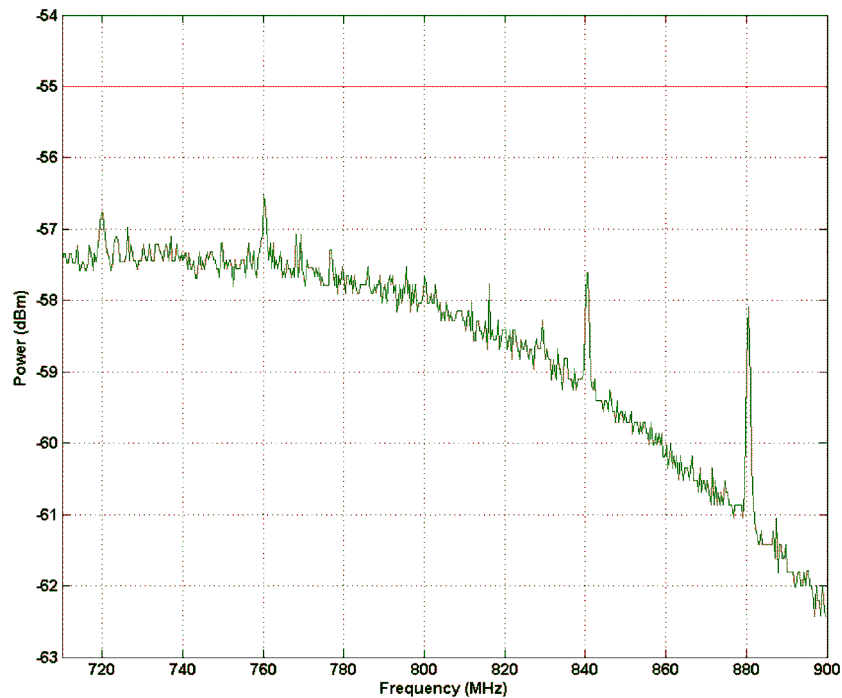

**Figure 4. Spurious Emission 40 MHz - 710 MHz**

|           |                              |
|-----------|------------------------------|
| Limit:    | -36 dBm/100 kHz              |
| Measured: | -57 dBm (max over 6 samples) |
| Margin:   | 21 dB (Pass)                 |

### 3.4.2 Spurious Emission 710 MHz – 900 MHz

The allowed level of spurious emissions within the 710 MHz - 900 MHz frequency band is specified as less than -55 dBm in any 1 MHz bandwidth. The channel center frequency selected for this measurement is 920.6 MHz. The measured spurious emissions within this frequency band are shown in [Figure 5](#).

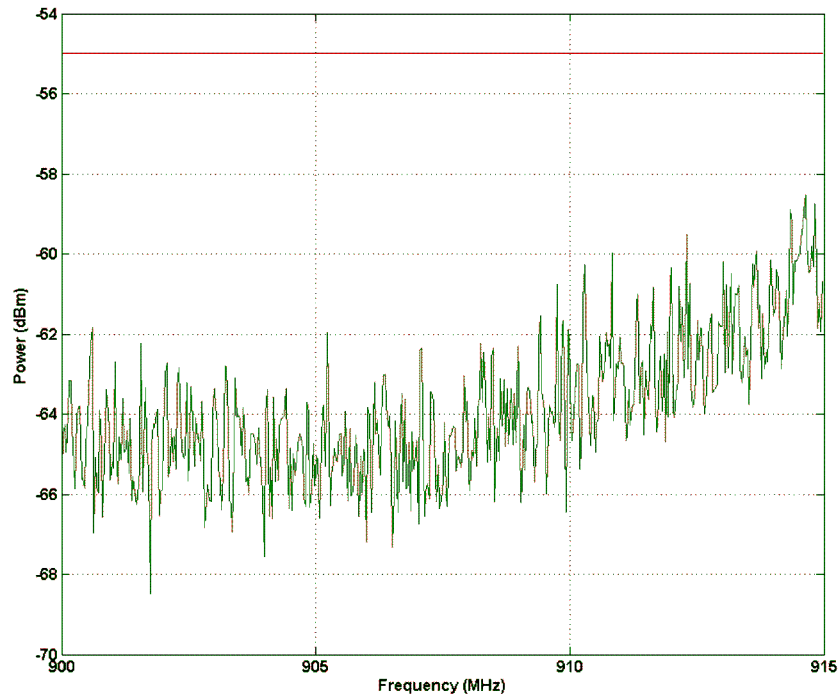

**Figure 5. Spurious Emission 710 MHz - 900 MHz**

|           |                              |
|-----------|------------------------------|
| Limit:    | -55 dBm/1 MHz                |
| Measured: | -56.5 dBm (max of 6 samples) |
| Margin:   | 1.5 dB (Pass)                |

### 3.4.3 Spurious Emission 900 MHz – 915 MHz

The allowed level of spurious emissions within the 900 MHz - 915 MHz frequency band is specified as less than -55 dBm in any 100 kHz bandwidth. The channel center frequency selected for this measurement is 920.6 MHz. The measured spurious emissions within this frequency band are shown in Figure 6.



**Figure 6. Spurious Emission 900 MHz - 915 MHz**

|           |                              |
|-----------|------------------------------|
| Limit:    | -55 dBm/100 kHz              |
| Measured: | -57 dBm (max over 6 samples) |
| Margin:   | 2 dB (Pass)                  |

### 3.4.4 Spurious Emission 915 MHz - 930 MHz

The allowed level of spurious emissions within the 915 MHz -930 MHz frequency band is specified as less than -36 dBm in any 100 kHz bandwidth <sup>(1)</sup>.

The measurement method that should be used is outlined in TELEC-T245. According to 2(5) in TELEC-T245 the frequency band between 915 MHz and 930 MHz should be measured with a RBW equal to 3 kHz <sup>(2)</sup> with max peak detector with a single sweep. The result of this measurement is shown in Figure 7 and Figure 8. If the measured amplitude of spurious emission using single sweep exceeds the standard the spurious emission should be calculated according to TELEC-T245 in Chapter 4 (7) to (16):

- Measure the total average power ( $P_b$ )
- Measure the average power in the used unit channel(s) ( $P_c$ ) in watts
- Measure the average power of the spurious emission for all frequencies that exceed the limit in watts. ( $P_s$ )
- Calculate the unwanted emission power as  $(P_s/P_c)*P_b$

<sup>(1)</sup> Except for  $|f-f_c| > (200+100x_n)$  kHz for unit channel bandwidth 200 kHz and  $|f-f_c| < (100+50x_n)$  kHz for 100 kHz unit channel bandwidth  
For 915.9 MHz  $< f < 916.9$  MHz and 920.5 MHz  $< f < 922.3$  MHz: Except  $|f-f_c| < (100+100x_n)$  kHz.

<sup>(2)</sup> The limit is then adjusted by  $10*\log_{10}(100 \text{ kHz}/3 \text{ kHz})$ .

A Matlab script was developed to simplify the calculation.

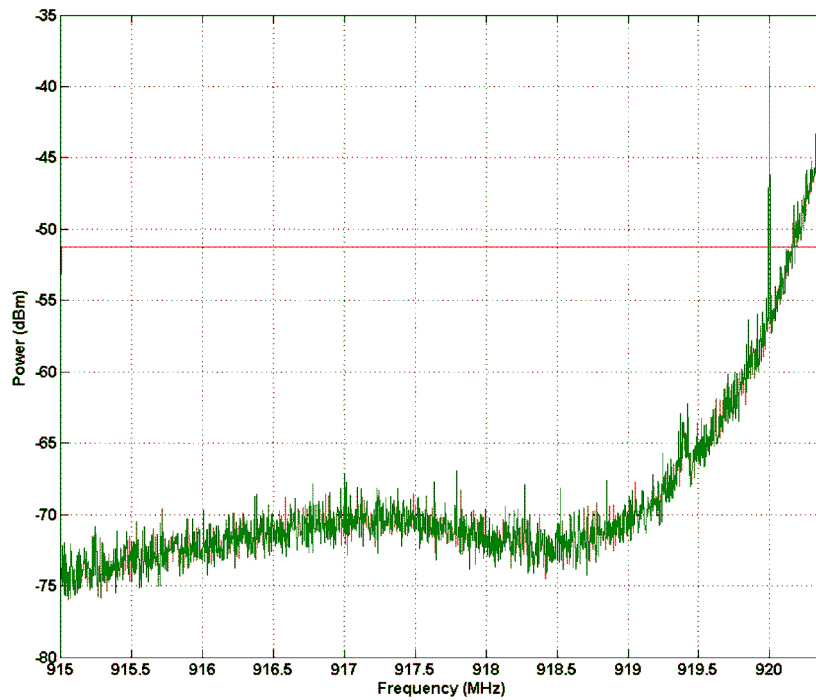

**Figure 7. Spurious Emission 915 MHz - 920.4 MHz**

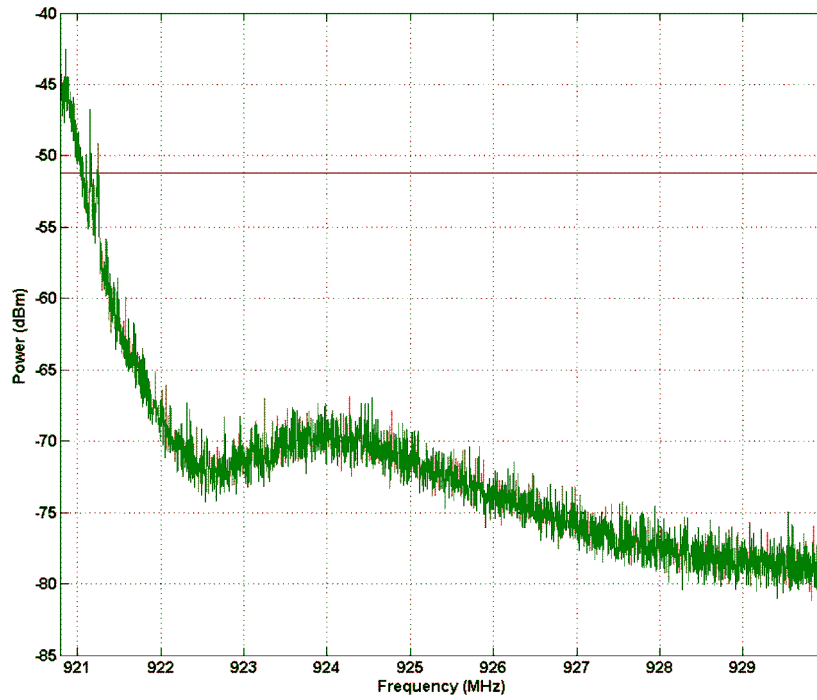

**Figure 8. Spurious Emission 920.8 MHz - 930 MHz**

|           |                        |
|-----------|------------------------|
| Limit:    | -36 dBm/100 kHz        |
| Measured: | -39 dBm <sup>(1)</sup> |
| Margin:   | 3 dB (Pass)            |

<sup>(1)</sup> Measured using the Matlab script.

### 3.4.5 Spurious Emission 930 MHz - 1000 MHz

The allowed level of spurious emissions within the 930 MHz - 1000 MHz frequency band is specified as less than -55 dBm in any 100 kHz bandwidth. The channel center frequency selected for this measurement is 920.6 MHz. The measured spurious emissions within this frequency band are shown in Figure 9.

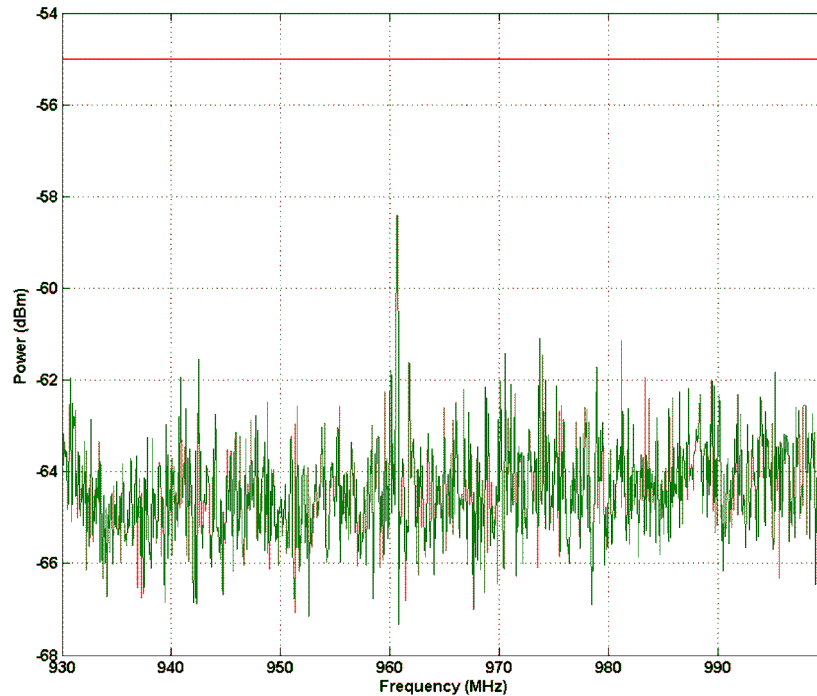

**Figure 9. Spurious Emission 930 MHz - 1000 MHz**

|           |                              |
|-----------|------------------------------|
| Limit:    | -55 dBm/100 kHz              |
| Measured: | -58 dBm (max over 6 samples) |
| Margin:   | 3 dB (Pass)                  |



### 3.4.6 Spurious Emission 1000 MHz - 1215 MHz

The allowed level of spurious emissions within the 1000 MHz -1215 MHz frequency band is specified as less than -45 dBm in any 1 MHz bandwidth. The channel center frequency selected for this measurement is 920.6 MHz. The measured spurious emissions within this frequency band are shown in [Figure 10](#).

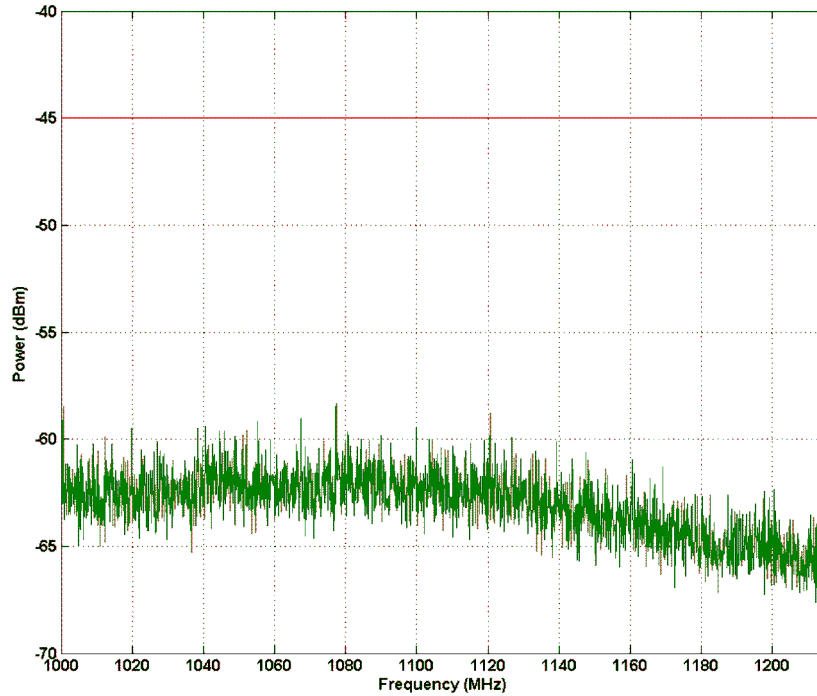
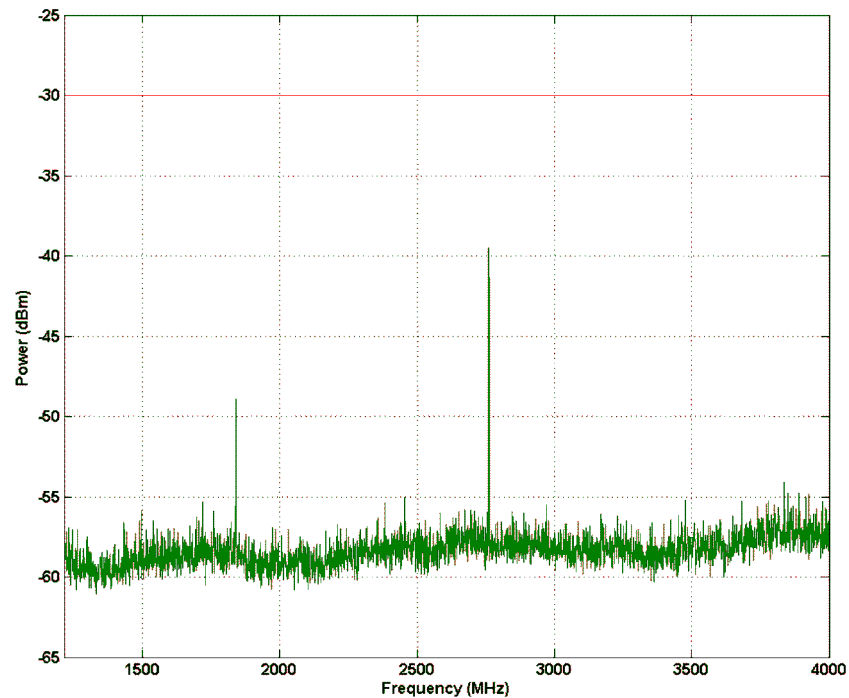

**Figure 10. Spurious Emission 1000 MHz - 1215 MHz**

|           |                              |
|-----------|------------------------------|
| Limit:    | -45 dBm/1 MHz                |
| Measured: | -58 dBm (max over 6 samples) |
| Margin:   | 13 dB (Pass)                 |

### 3.4.7 Spurious Emission 1215 MHz ->

The allowed level of spurious emissions above 1215 MHz frequency is specified as less than -30 dBm in any 1 MHz bandwidth. The channel center frequency selected for this measurement is 920.6 MHz. The measured spurious emissions within this frequency band are shown in [Figure 11](#).



**Figure 11. Spurious Emission Above 1215 MHz**

|           |                              |
|-----------|------------------------------|
| Limit:    | -30 dBm/1 MHz                |
| Measured: | -40 dBm (max over 6 samples) |
| Margin:   | 10 dB (Pass)                 |

#### 4 RX Conducted Measurements: CC1200EM 868-930

Sensitivity is measured with the following settings:

- 50 kbps, 25 kHz deviation (2GFSK), RX BW 100 kHz
- 100 kbps, 50 kHz deviation (2GFSK), RX BW 200 kHz

**Table 17. Sensitivity**

| Data Rate | Sensitivity [dBm] |
|-----------|-------------------|
| 50 kbps   | -108              |
| 100 kbps  | -106              |

#### TX Conducted Measurements: CC1200EM 920

The TX conducted measurements are measured according to the “low-power radio station” part of the standard.

##### 4.1 Output Power

Dependent on frequency band the maximum output power is 1 mW (0 dBm) or 20 mW (+13 dBm). To achieve +13 dBm with this EM, the bias current in the PA is increased by setting PA\_CFG3=0x02.

**Table 18. Output Power +13 dBm**

| Setting [PA_CFG1] | Output Power [dBm] |
|-------------------|--------------------|
| 7F                | 14.0               |
| 7E                | 13.7               |
| 7D                | 13.2               |
| 7C                | 12.6               |
| 7B                | 12.1               |

For 0 dBm nominal PA bias current is used.

**Table 19. Output Power 0 dBm**

| Setting [PA_CFG1] | Output Power [dBm] |
|-------------------|--------------------|
| 6E                | 0.8                |
| 6D                | 0.3                |
| 6C                | -0.2               |
| 6B                | -0.7               |
| 6A                | -1.3               |

The following register settings are used for the measurements in this section:

- +13 dBm:
  - PA\_CFG1 = 0x7D
  - PA\_CFG3 = 0x02
  - FS\_DIG1 = 0x04
  - FS\_DIG0 = 0x55
- 0 dBm:
  - PA\_CFG1 = 0x66

## 4.2 Occupied Bandwidth (OBW)

The permitted occupied bandwidth is defined as 99% of the power within  $n$  Unit Channel bandwidth where the Unit Channel Bandwidth is 100 kHz or 200 kHz depending on the sub frequency band and  $n$  is the number of Unity Channels. The OBW is dependent on the modulation.

- 50 kbps, 25 kHz deviation (2GFSK): OBW = 84 kHz
- 100 kbps, 50 kHz deviation (2GFSK): OBW = 166 kHz

## 4.3 ACP

The Adjacent Channel leakage power requirements are divided into four different masks dependent on the frequency. The measurements are done with the stated data rate and unit channels.

- 50 kbps, 25 kHz deviation (2GFSK)
- 100 kbps, 50 kHz deviation (2GFSK)

### 4.3.1 ACP Mask 1

**Table 20. ACP Mask 1 Results**

| Frequency                  | 915.9 MHz – 916.8 MHz. Max 0 dBm |                |                            |
|----------------------------|----------------------------------|----------------|----------------------------|
| Specification              | Required [dBm]                   | Measured [dBm] |                            |
| <b>Power @channel edge</b> | -20                              | -44            | @50 kbps, unit ch num 1    |
|                            |                                  | -13            | @100 kbps, unit ch num 1   |
|                            |                                  | -46            | @100 kbps, unit ch num 1,2 |
| <b>ACP</b>                 | <-26                             | -51            | @50 kbps, unit ch num 1    |
|                            |                                  | -30            | @100 kbps, unit ch num 1   |
|                            |                                  | -53            | @100 kbps, unit ch num 1,2 |

To comply with the power at the channel edge requirement 2 unit channels have to be used if the data rate is 100 kbps.

### 4.3.2 ACP Mask 2

**Table 21. ACP Mask 2 Results**

| Frequency                  | 920.5 MHz – 922.3 MHz. Max +13 dBm |                |                              |
|----------------------------|------------------------------------|----------------|------------------------------|
| Specification              | Required [dBm]                     | Measured [dBm] |                              |
| <b>Power @channel edge</b> | -7                                 | -27            | @50 kbps, unit ch num 24     |
|                            |                                    | 0              | @100 kbps, unit ch num 24    |
|                            |                                    | -29            | @100 kbps, unit ch num 24,25 |
| <b>ACP</b>                 | <-15                               | -36            | @50 kbps, unit ch num 24     |
|                            |                                    | -16            | @100 kbps, unit ch num 24    |
|                            |                                    | -39            | @100 kbps, unit ch num 24,25 |

The ACP limit change to < -26 dBm if the output power is less than 0dBm. For measurements for this mask only 13 dBm output power is used.

To comply with the power at the channel edge requirement 2 unit channels have to be used if the data rate is 100 kbps.

### 4.3.3 ACP Mask 3

**Table 22. ACP Mask 3 Results**

| Frequency                  | 922.3 MHz – 928.1 MHz |                   |   |
|----------------------------|-----------------------|-------------------|---|
| Specification              | Required [dBm]        | Measured [dBm]    |   |
| <b>Power @channel edge</b> | -26                   | -51<br>-30<br>-49 | @50 kbps, unit ch num 33<br>@100 kbps, unit ch num 33<br>@100 kbps, unit ch num 33,34 |
| <b>ACP</b>                 | <-15                  | -37<br>-16<br>-39 | @50 kbps, unit ch num 33<br>@100 kbps, unit ch num 33<br>@100 kbps, unit ch num 33,34 |

### 4.3.4 ACP Mask 4

**Table 23. ACP Mask 4 Results**

| Frequency     | 928.1 MHz – 929.7 MHz. Max 0 dBm |                |  |
|---------------|----------------------------------|----------------|--|
| Specification | Required [dBm]                   | Measured [dBm] |  |
| <b>ACP</b>    | <-26                             | -30<br>-50     | @50 kbps, unit ch num 62<br>@100 kbps, unit ch num 62,63 |

## 4.4 Unwanted Emission Intensity

The allowed levels for spurious emissions are described in [Table 9](#).

### 4.4.1 Spurious Emission 40 MHz – 710 MHz

The allowed level of spurious emissions within the 40 MHz -710 MHz frequency band is specified as less than -36 dBm in any 100 kHz bandwidth. The channel center frequency selected for this measurement is 920.6 MHz. The measured spurious emissions within this frequency band are shown in [Figure 12](#).

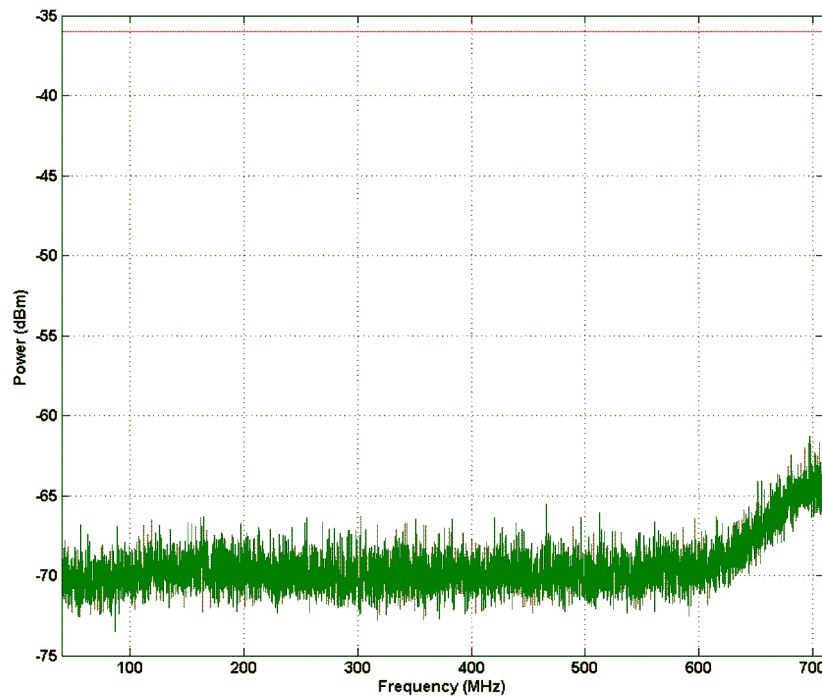
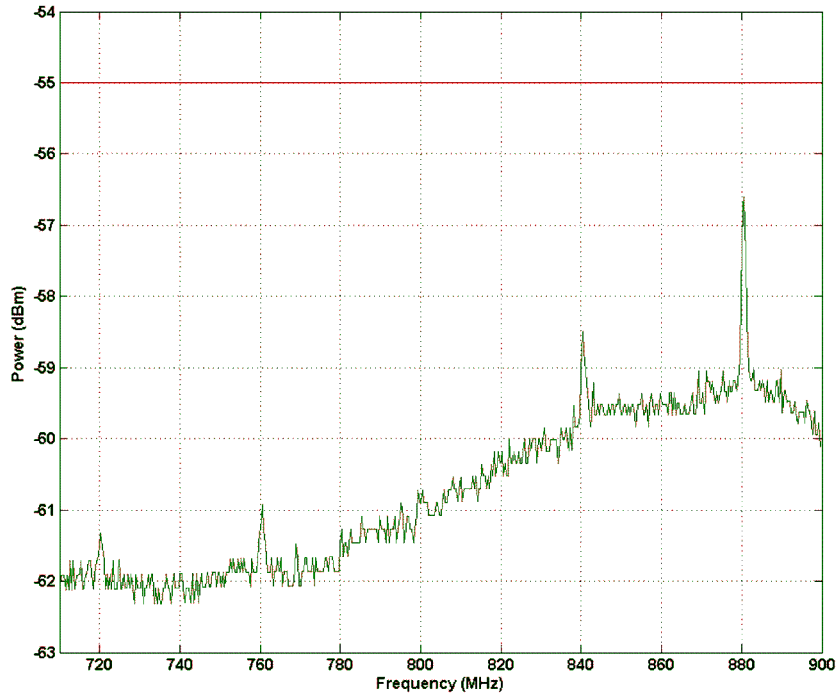

**Figure 12. Spurious Emission 40 MHz - 710 MHz**

|           |                              |
|-----------|------------------------------|
| Limit:    | -36 dBm/100 kHz              |
| Measured: | -61 dBm (max over 6 samples) |
| Margin:   | 25 dB (Pass)                 |

#### 4.4.2 Spurious Emission 710 MHz – 900 MHz

The allowed level of spurious emissions within the 710 MHz - 900 MHz frequency band is specified as less than -55 dBm in any 1 MHz bandwidth. The channel center frequency selected for this measurement is 920.6 MHz. The measured spurious emissions within this frequency band are shown in [Figure 13](#).

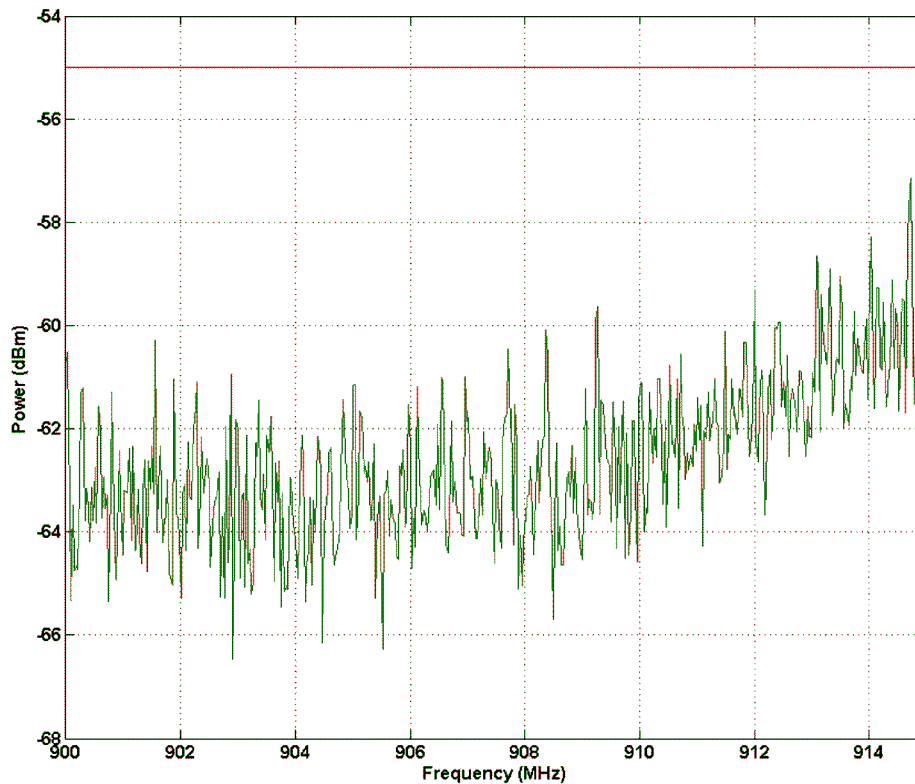

**Figure 13. Spurious Emission 710 MHz - 900 MHz**

|           |                                |
|-----------|--------------------------------|
| Limit:    | -55 dBm/1 MHz                  |
| Measured: | -56.5 dBm (max over 6 samples) |
| Margin:   | 1.5 dB (Pass)                  |

#### 4.4.3 Spurious Emission 900 MHz – 915 MHz

The allowed level of spurious emissions within the 900 MHz - 915 MHz frequency band is specified as less than -55 dBm in any 100 kHz bandwidth. The channel center frequency selected for this measurement is 920.6 MHz. The measured spurious emissions within this frequency band are shown in [Figure 14](#).



**Figure 14. Spurious Emission 900 MHz - 915 MHz**

|           |                              |
|-----------|------------------------------|
| Limit:    | -55 dBm/100 kHz              |
| Measured: | -57 dBm (max over 6 samples) |
| Margin:   | 2 dB (Pass)                  |



#### 4.4.4 Spurious Emission 915 MHz - 930 MHz

The allowed level of spurious emissions within the 915 MHz -930 MHz frequency band is specified as less than -36dBm in any 100 kHz bandwidth <sup>(1)</sup>.

The measurement method that should be used is outlined in TELEC-T245. According to 2(5) in TELEC-T245, the frequency band between 915 MHz and 930 MHz should be measured with a RBW equal to 3 kHz <sup>(2)</sup> with max peak detector with a single sweep. The result of this measurement is shown in [Figure 15](#) and [Figure 16](#). If the measured amplitude of spurious emission using single sweep exceeds the standard, the spurious emission should be calculated according to TELEC-T245 Chapter 4 (7) to (16):

- Measure the total average power (Pb)
- Measure the average power in the used unit channel(s) (Pc) in watts
- Measure the average power of the spurious emission for all frequencies that exceed the limit in watts. (Ps)
- Calculate the unwanted emission power as (Ps/Pc)\*Pb

A Matlab script was developed to simplify the calculation.

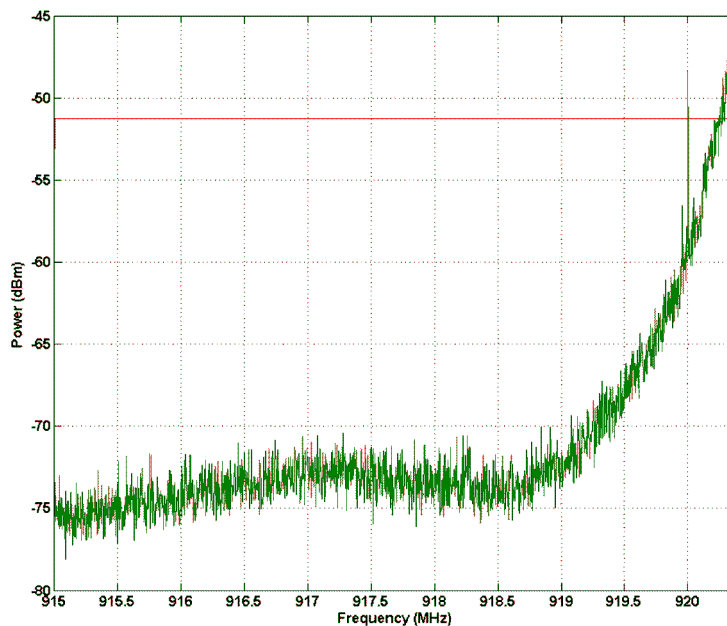

**Figure 15. Spurious Emission 915 MHz - 920.4 MHz**

<sup>(1)</sup> Except for  $|f-f_c| > (200+100x_n)$  kHz for unit channel bandwidth 200 kHz and  $|f-f_c| < (100+50x_n)$  kHz for 100 kHz unit channel bandwidth. For 915.9 MHz  $< f < 916.9$  MHz and 920.5 MHz  $< f < 922.3$  MHz: Except  $|f-f_c| < (100+100x_n)$  kHz.

<sup>(2)</sup> The limit is then adjusted by  $10 \cdot \log_{10}(100 \text{ kHz}/3 \text{ kHz})$ .

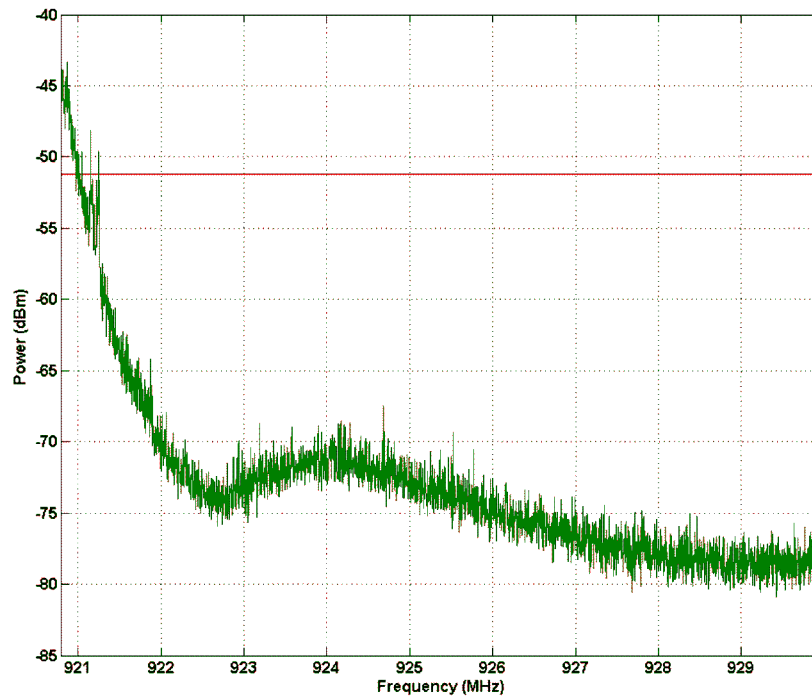
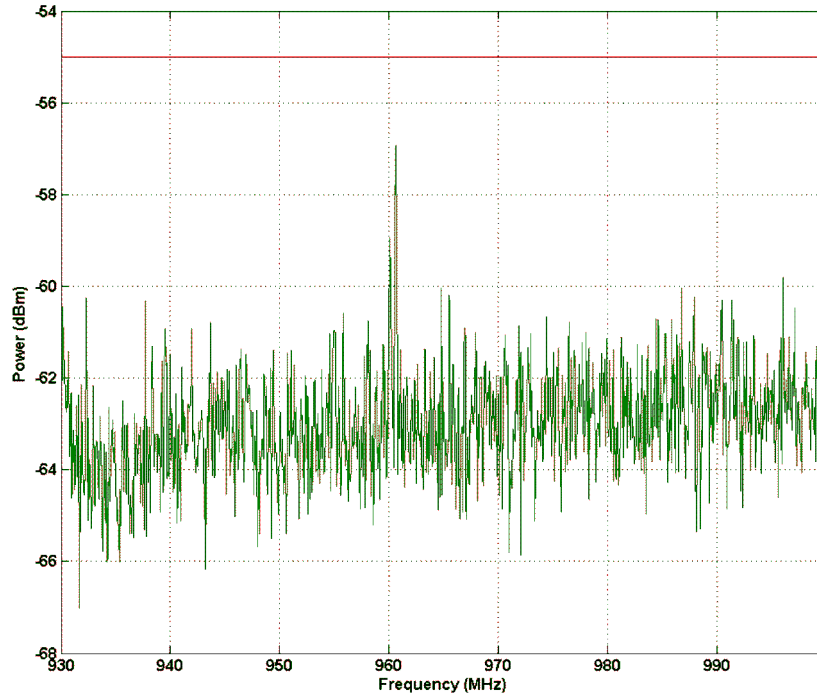

**Figure 16. Spurious Emission 920.8 MHz - 930 MHz**

|           |                 |
|-----------|-----------------|
| Limit:    | -36 dBm/100 kHz |
| Measured: | -38 dBm         |
| Margin:   | 2 dB (Pass)     |

#### 4.4.5 Spurious Emission 930 MHz - 1000 MHz

The allowed level of spurious emissions within the 930 MHz - 1000 MHz frequency band is specified as less than -55 dBm in any 100 kHz bandwidth. The channel center frequency selected for this measurement is 920.6 MHz. The measured spurious emissions within this frequency band are shown in Figure 17.

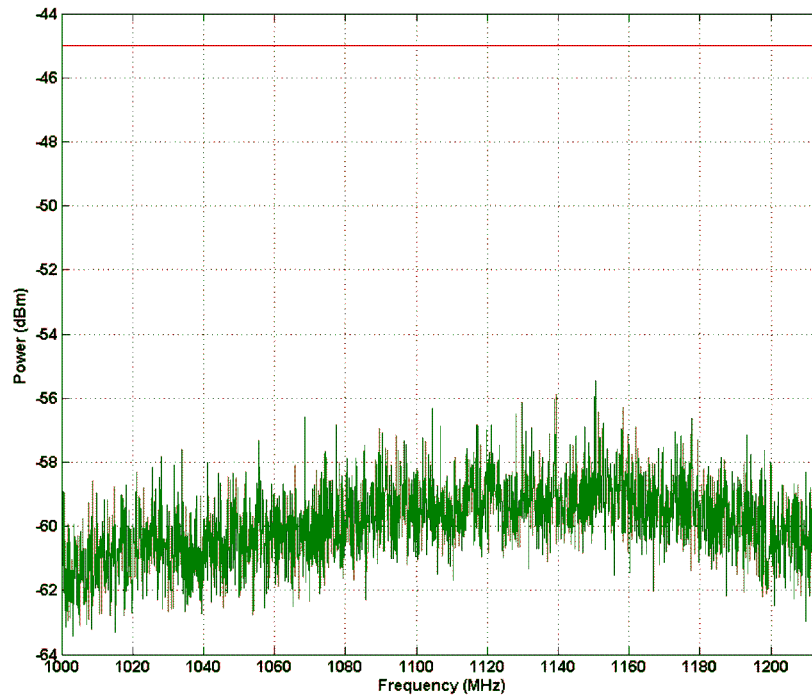

**Figure 17. Spurious Emission 930 MHz - 1000 MHz**

|           |                              |
|-----------|------------------------------|
| Limit:    | -55 dBm/100 kHz              |
| Measured: | -57 dBm (max over 6 samples) |
| Margin:   | 2 dB (Pass)                  |

#### 4.4.6 Spurious Emission 1000 MHz - 1215 MHz

The allowed level of spurious emissions within the 1000 MHz -1215 MHz frequency band is specified as less than -45 dBm in any 1 MHz bandwidth. The channel center frequency selected for this measurement is 920.6 MHz. The measured spurious emissions within this frequency band are shown in [Figure 18](#).

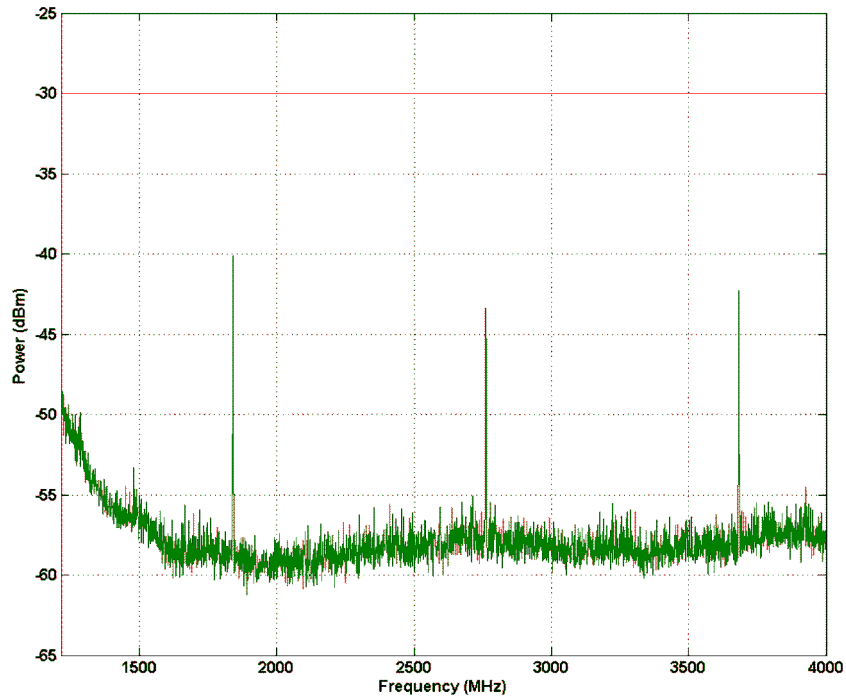

**Figure 18. Spurious Emission 1000 MHz - 1215 MHz**

|           |                              |
|-----------|------------------------------|
| Limit:    | -45 dBm/1 MHz                |
| Measured: | -55 dBm (max over 6 samples) |
| Margin:   | 10 dB (Pass)                 |

**4.4.7 Spurious Emission 1215 MHz ->**

The allowed level of spurious emissions above 1215 MHz frequency is specified as less than -30 dBm in any 1 MHz bandwidth. The channel center frequency selected for this measurement is 920.6 MHz. The measured spurious emissions within this frequency band are shown in [Figure 19](#).



**Figure 19. Spurious Emission Above 1215 MHz**

|           |                              |
|-----------|------------------------------|
| Limit:    | -30 dBm/1 MHz                |
| Measured: | -40 dBm (max over 6 samples) |
| Margin:   | 10 dB (Pass)                 |

**5 RX Conducted Measurements: CC1200EM 920**

Sensitivity is measured with the following settings:

- 50 kbps, 25 kHz deviation (2GFSK), RX BW 100 kHz
- 100 kbps, 50 kHz deviation (2GFSK), RX BW 200 kHz

**Table 24. Sensitivity**

| Data Rate | Sensitivity [dBm] |
|-----------|-------------------|
| 50 kbps   | -107              |
| 100 kbps  | -104              |

## 6 TX Conducted Measurements: CC1200 920 IPC

The TX conducted measurements are measured according to the “low-power radio station” standard referenced in [Section 2](#).

### 6.1 Output Power

Dependent on frequency band, the maximum output power is 1 mW (0 dBm) or 20 mW (+13 dBm). To achieve +13 dBm with this EM, the bias current in the PA is increased by setting PA\_CFG3 = 0x02.

**Table 25. Output Power +13 dBm**

| Setting [PA_CFG1] | Output Power [dBm] |
|-------------------|--------------------|
| 7F                | 13.3               |
| 7E                | 13.1               |
| 7D                | 12.9               |
| 7C                | 12.6               |
| 7B                | 12.4               |

For 0 dBm, nominal PA bias current is used.

**Table 26. Output Power 0 dBm**

| Setting [PA_CFG1] | Output Power [dBm] |
|-------------------|--------------------|
| 68                | 0.7                |
| 67                | 0.2                |
| 66                | -0.2               |
| 65                | -0.8               |
| 64                | -1.3               |

The following register settings are used for the measurements in this section:

- +13 dBm:
  - PA\_CFG1 = 0x7E
  - PA\_CFG3 = 0x02
  - FS\_DIG1 = 0x04
  - FS\_DIG0 = 0x55
- 0 dBm:
  - PA\_CFG1 = 0x67

### 6.2 Occupied Bandwidth (OBW)

The permitted occupied bandwidth is defined as 99% of the power within  $n \times$  Unit Channel bandwidth where the Unit Channel Bandwidth is 100 kHz or 200 kHz depending on the sub frequency band and  $n$  is the number of Unity Channels. The OBW is dependent on the modulation.

- 50 kbps, 25 kHz deviation (2GFSK): OBW = 84 kHz
- 100 kbps, 50 kHz deviation (2GFSK): OBW = 170 kHz

### 6.3 ACP

The Adjacent Channel leakage power requirements are divided into four different masks dependent on the frequency. The measurements are done with the stated data rate and unit channels.

- 50 kbps, 25 kHz deviation (2GFSK)
- 100 kbps, 50 kHz deviation (2GFSK)

### 6.3.1 ACP Mask 1

**Table 27. ACP Mask 1 Results**

| Frequency                  | 915.9 MHz – 916.8 MHz. Max 0 dBm |                |                            |
|----------------------------|----------------------------------|----------------|----------------------------|
| Specification              | Required [dBm]                   | Measured [dBm] |                            |
| <b>Power @channel edge</b> | -20                              | -52            | @50 kbps, unit ch num 1    |
|                            |                                  | -20            | @100 kbps, unit ch num 1   |
|                            |                                  | -50            | @100 kbps, unit ch num 1,2 |
| <b>ACP</b>                 | <-26                             | -48            | @50 kbps, unit ch num 1    |
|                            |                                  | -30            | @100 kbps, unit ch num 1   |
|                            |                                  | -50            | @100 kbps, unit ch num 1,2 |

To comply with the power at the channel edge, requirement 2 unit channels have to be used if the data rate is 100 kbps.

### 6.3.2 ACP Mask 2

**Table 28. ACP Mask 2 Results**

| Frequency                  | 920.5 MHz – 922.3 MHz. Max 13 dBm |                |                              |
|----------------------------|-----------------------------------|----------------|------------------------------|
| Specification              | Required [dBm]                    | Measured [dBm] |                              |
| <b>Power @channel edge</b> | -7                                | -37            | @50 kbps, unit ch num 24     |
|                            |                                   | -8             | @100 kbps, unit ch num 24    |
|                            |                                   | -39            | @100 kbps, unit ch num 24,25 |
| <b>ACP</b>                 | <-15                              | -35            | @50 kbps, unit ch num 24     |
|                            |                                   | -16            | @100 kbps, unit ch num 24    |
|                            |                                   | -37            | @100 kbps, unit ch num 24,25 |

The ACP limit change to < -26 dBm if the output power is less than 0dBm. For measurements for this mask, only 13 dBm output power is used.

To comply with the power at the channel edge requirement, 2 unit channels have to be used if the data rate is 100 kbps.

### 6.3.3 ACP Mask 3

**Table 29. ACP Mask 3 Results**

| Frequency                  | 922.3 MHz – 928.1 MHz |                |                              |
|----------------------------|-----------------------|----------------|------------------------------|
| Specification              | Required [dBm]        | Measured [dBm] |                              |
| <b>Power @channel edge</b> | <-26                  | -48            | @50 kbps, unit ch num 33     |
|                            |                       | -16            | @100 kbps, unit ch num 33    |
|                            |                       | -50            | @100 kbps, unit ch num 33,36 |
| <b>ACP</b>                 | <-15                  | -35            | @50 kbps, unit ch num 33     |
|                            |                       | -16            | @100 kbps, unit ch num 33    |
|                            |                       | -37            | @100 kbps, unit ch num 33,36 |

### 6.3.4 ACP Mask 4

**Table 30. ACP Mask 3 Results**

|                      |                                  |                |  |
|----------------------|----------------------------------|----------------|--|
| <b>Frequency</b>     | 928.1 MHz – 929.7 MHz. Max 0 dBm |                |  |
| <b>Specification</b> | Required [dBm]                   | Measured [dBm] |  |
| <b>ACP</b>           | <-26                             | -29<br>-52     | @50 kbps, unit ch num 62<br>@100 kbps, unit ch num 62,63 |

## 6.4 Unwanted Emission Intensity

The allowed levels for spurious emissions are described in [Table 9](#).

### 6.4.1 Spurious Emission 40 MHz – 710 MHz

The allowed level of spurious emissions within the 40 MHz -710 MHz frequency band is specified as less than -36 dBm in any 100 kHz bandwidth. The channel center frequency selected for this measurement is 920.6 MHz. The measured spurious emissions within this frequency band are shown in [Figure 20](#).

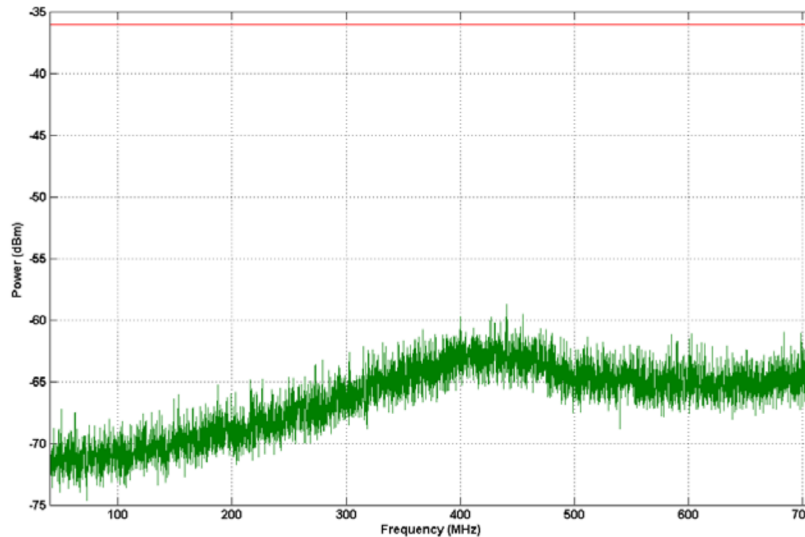

**Figure 20. Spurious Emission 40 MHz - 710 MHz**

|           |                              |
|-----------|------------------------------|
| Limit:    | -36 dBm/100 kHz              |
| Measured: | -58 dBm (max over 6 samples) |
| Margin:   | 22 dB (Pass)                 |



### 6.4.2 Spurious Emission 710 MHz – 900 MHz

The allowed level of spurious emissions within the 710 MHz - 900 MHz frequency band is specified as less than -55 dBm in any 1 MHz bandwidth. The channel center frequency selected for this measurement is 920.6 MHz. The measured spurious emissions within this frequency band are shown in [Figure 21](#).

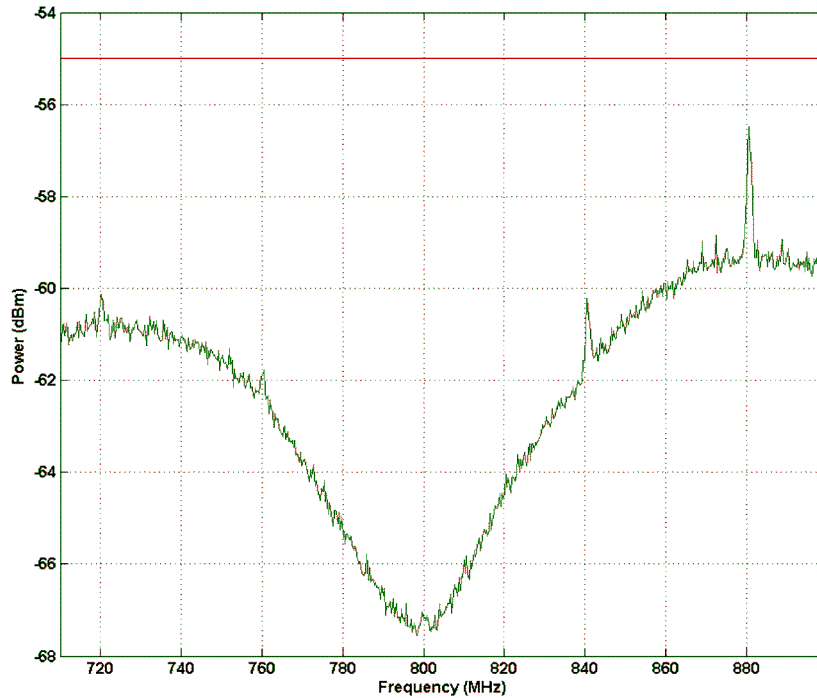

**Figure 21. Spurious Emission 710 MHz - 900 MHz**

|           |                                |
|-----------|--------------------------------|
| Limit:    | -55 dBm/1 MHz                  |
| Measured: | -56.6 dBm (max over 6 samples) |
| Margin:   | 1.5 dB (Pass)                  |

### 6.4.3 Spurious Emission 900 MHz – 915 MHz

The allowed level of spurious emissions within the 900 MHz - 915 MHz frequency band is specified as less than -55 dBm in any 100 kHz bandwidth. The channel center frequency selected for this measurement is 920.6 MHz. The measured spurious emissions within this frequency band are shown in Figure 22.

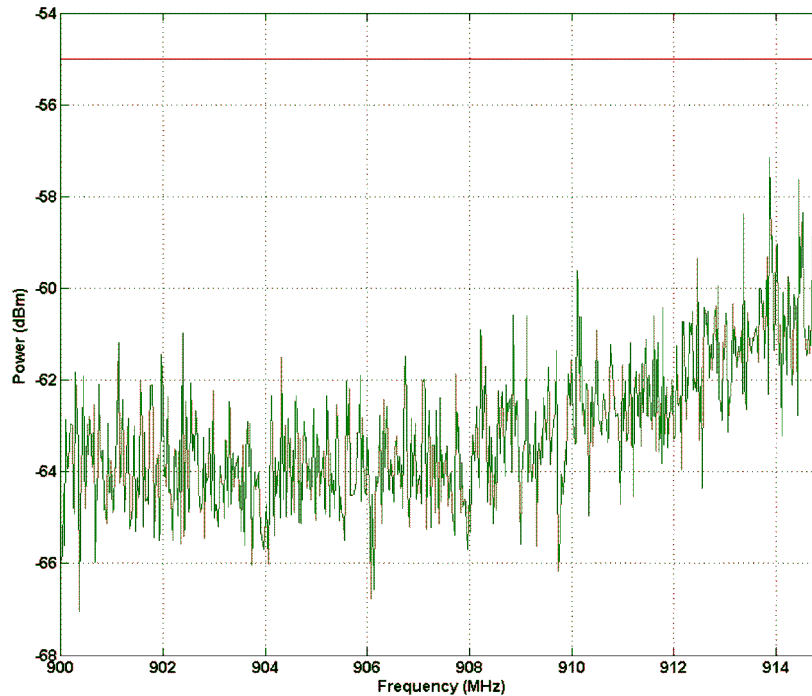

Figure 22. Spurious Emission 900 MHz - 915 MHz

|           |                              |
|-----------|------------------------------|
| Limit:    | -55 dBm/100 kHz              |
| Measured: | -57 dBm (max over 6 samples) |
| Margin:   | 2 dB (Pass)                  |

### 6.4.4 Spurious Emission 915 MHz - 930 MHz

The allowed level of spurious emissions within the 915 MHz -930 MHz frequency band is specified as less than -36dBm in any 100 kHz bandwidth . <sup>(1)</sup>

The measurement method that should be used is outlined in TELEC-T245. According to 2(5) in TELEC-T245, the frequency band between 915 MHz and 930 MHz should be measured with a RBW equal to 3 kHz <sup>(2)</sup> with max peak detector with a single sweep. The result of this measurement is shown in Figure 23 and Figure 24. If the measured amplitude of spurious emission using single sweep exceeds the standard, the spurious emission should be calculated according to TELEC-T245 Chapter 4 (7) to (16):

- The limit is then adjusted by  $10 \cdot \log_{10}(100 \text{ kHz}/3 \text{ kHz})$
- Measure the average power in the used unit channel(s) ( $P_c$ ) in watts
- Measure the average power of the spurious emission for all frequencies that exceed the limit in watts. ( $P_s$ )
- Calculate the unwanted emission power as  $(P_s/P_c) \cdot P_b$

<sup>(1)</sup> Except for  $|f-f_c| > (200+100x_n) \text{ kHz}$  for unit channel bandwidth 200 kHz and  $|f-f_c| < (100+50x_n) \text{ kHz}$  for 100 kHz unit channel bandwidth. For  $915.9 \text{ MHz} < f < 916.9 \text{ MHz}$  and  $920.5 \text{ MHz} < f < 922.3 \text{ MHz}$ : Except  $|f-f_c| < (100+100x_n) \text{ kHz}$ .

<sup>(2)</sup> The limit is then adjusted by  $10 \cdot \log_{10}(100 \text{ kHz}/3 \text{ kHz})$ .

A Matlab script was developed to simplify the calculation.

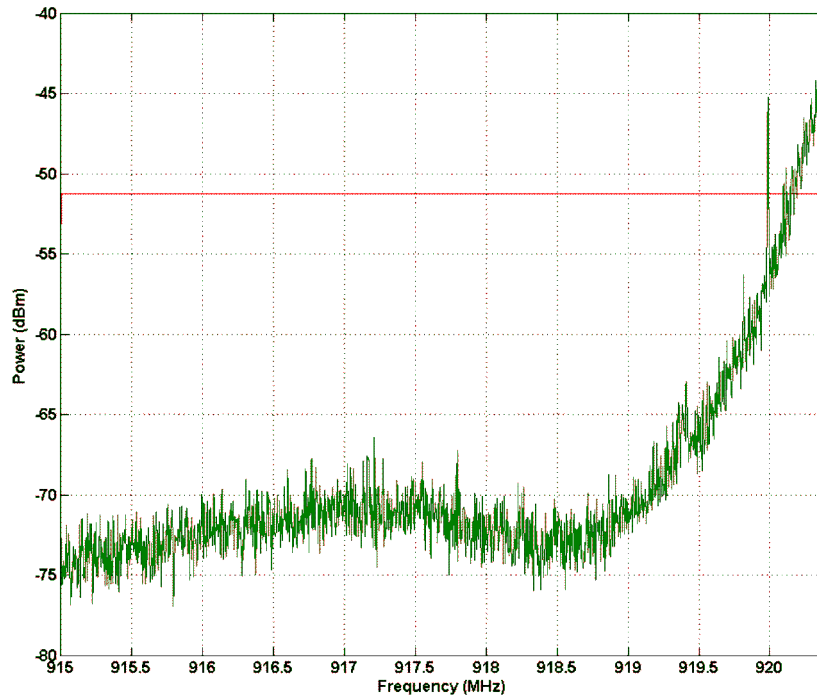

**Figure 23. Spurious Emission 915 MHz - 920.4 MHz**

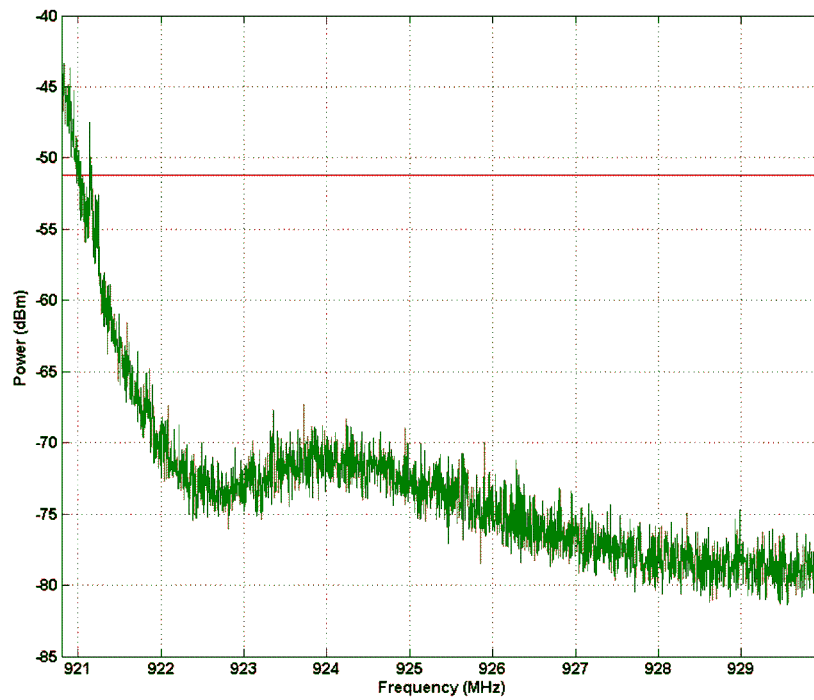
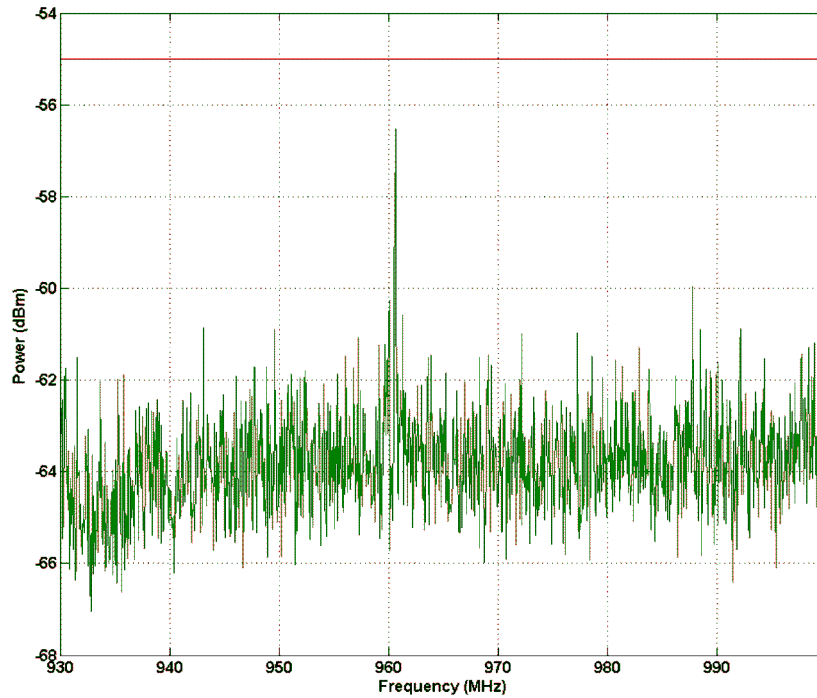

**Figure 24. Spurious Emission 920.8 MHz - 930 MHz**

|           |                 |
|-----------|-----------------|
| Limit:    | -36 dBm/100 kHz |
| Measured: | -40 dBm         |
| Margin:   | 4 dB (Pass)     |

### 6.4.5 Spurious Emission 930 MHz - 1000 MHz

The allowed level of spurious emissions within the 930 MHz - 1000 MHz frequency band is specified as less than -55dBm in any 100 kHz bandwidth. The channel center frequency selected for this measurement is 920.6 MHz. The measured spurious emissions within this frequency band are shown in [Figure 25](#).

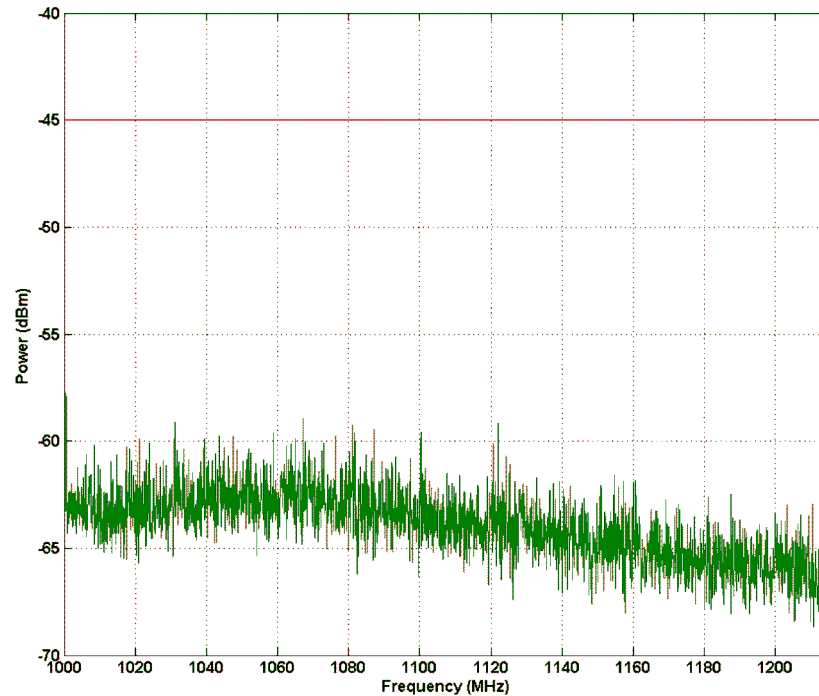

**Figure 25. Spurious Emission 930 MHz - 1000 MHz**

|           |                                |
|-----------|--------------------------------|
| Limit:    | -55 dBm/100 kHz                |
| Measured: | -56.5 dBm (max over 6 samples) |
| Margin:   | 1.5 dB (Pass)                  |

### 6.4.6 Spurious Emission 1000 MHz - 1215 MHz

The allowed level of spurious emissions within the 1000 MHz -1215 MHz frequency band is specified as less than -45 dBm in any 1 MHz bandwidth. The channel center frequency selected for this measurement is 920.6 MHz. The measured spurious emissions within this frequency band are shown in [Figure 26](#).

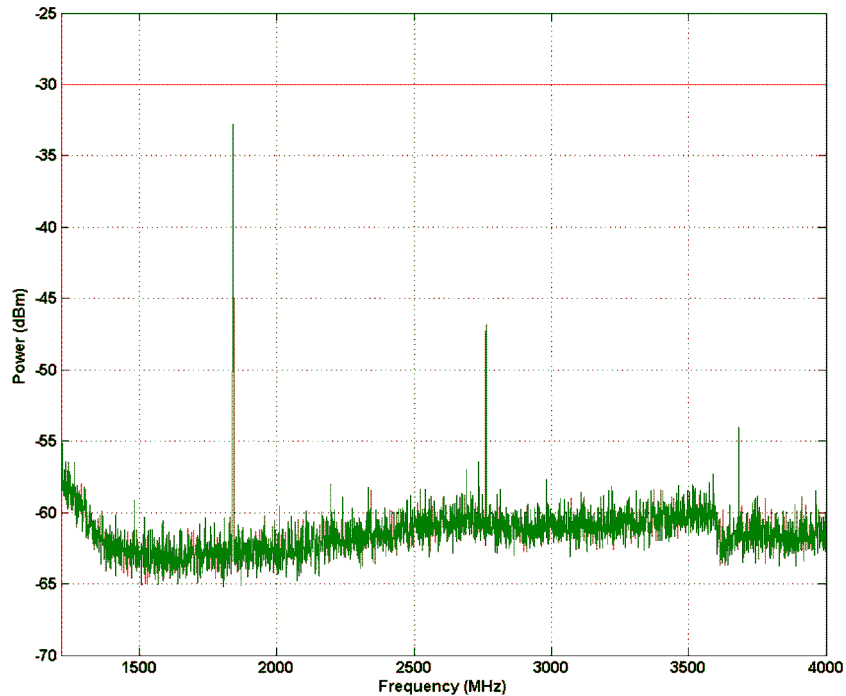

**Figure 26. Spurious Emission 1000 MHz - 1215 MHz**

|           |                              |
|-----------|------------------------------|
| Limit:    | -45 dBm/1 MHz                |
| Measured: | -58 dBm (max over 6 samples) |
| Margin:   | 13 dB (Pass)                 |

**6.4.7 Spurious Emission 1215 MHz ->**

The allowed level of spurious emissions above 1215 MHz frequency is specified as less than -30 dBm in any 1 MHz bandwidth. The channel center frequency selected for this measurement is 920.6 MHz. The measured spurious emissions within this frequency band are shown in [Figure 27](#).



**Figure 27. Spurious Emission Above 1215 MHz**

|           |                              |
|-----------|------------------------------|
| Limit:    | -30 dBm/1 MHz                |
| Measured: | -33 dBm (max over 6 samples) |
| Margin:   | 3 dB (Pass)                  |

**7 RX Conducted Measurements: CC1200EM 920 IPC**

Sensitivity is measured with the following settings:

- 50 kbps, 25 kHz deviation (2GFSK), RX BW 100 kHz
- 100 kbps, 50 kHz deviation (2GFSK), RX BW 200 kHz

**Table 31. Sensitivity**

| Data Rate | Sensitivity [dBm] |
|-----------|-------------------|
| 50 kbps   | -106              |
| 100 kbps  | -103              |

## 8 References

1. T108: [http://www.arib.or.jp/english/html/overview/doc/5-STD-T108v1\\_0-E2.pdf](http://www.arib.or.jp/english/html/overview/doc/5-STD-T108v1_0-E2.pdf)
2. TELEC\_T245: <http://www.telec.or.jp/eng/services/index.html>. For more information, contact TELEC.
3. CC1200EM 868-930: <http://www.ti.com/tool/cc1200emk-868-930>
4. CC1200 920:
5. CC1200 IPC 920:





A.2 CC1200EM 920

CC120x using XTAL: do not mount X2, C321, C322, R321, R322  
 CC120x using TCXO: do not mount R12, R321, C311, X1, C301: mount 0 Ohm resistor  
 R12 is a 0 Ohms shunt resistor that ground the EXT\_OSC pin when TCXO is not mounted

L1 is a Bead to be mounted if the regulator U2 is not mounted. By default the regulator is not mounted.

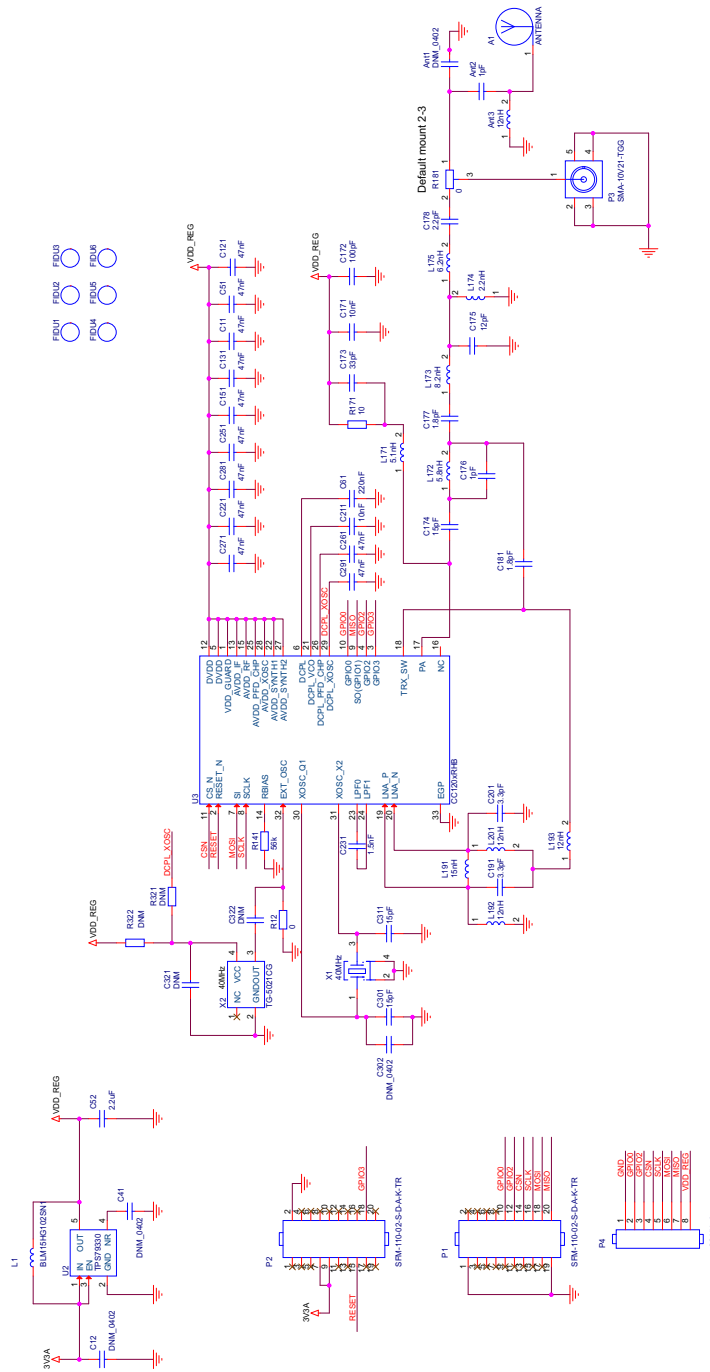

**A.3 CC1200EM IPC 920**
**Table 32. CC1200 EM Rev 1.2.2 920 MHz IPC**

|      |                      |   |                  |   |        |                |
|------|----------------------|---|------------------|---|--------|----------------|
| C11  | C_47N_0402_X7R_K_25  |   |                  | Capacitor, 47n, 0402, X7R, 10%, 25 V                    | Murata |                |
| C1   | C_1U_0805_X7R_K_16   |   |                  | Capacitor, 1 $\mu$ , 0805, X7R, 10%, 16 V               | Murata |                |
| C51  | C_47N_0402_X7R_K_25  |   |                  | Capacitor, 47n, 0402, X7R, 10%, 25 V                    | Murata |                |
| C61  | C_220N_0402_X5R_K_10 |   |                  | Capacitor, 220n, 0402, X5R, 10%, 10 V                   | Murata |                |
| C121 | C_47N_0402_X7R_K_25  |   |                  | Capacitor, 47n, 0402, X7R, 10%, 25 V                    | Murata |                |
| C131 | C_47N_0402_X7R_K_25  |   |                  | Capacitor, 47n, 0402, X7R, 10%, 25 V                    | Murata |                |
| C151 | C_47N_0402_X7R_K_25  |   |                  | Capacitor, 47n, 0402, X7R, 10%, 25 V                    | Murata |                |
| C171 | C_10N_0402_X7R_K_25  |   |                  | Capacitor, 10n, 0402, X7R, 10%, 25 V                    | Murata |                |
| C172 | C_100P_0402_NP0_J_50 |   |                  | Capacitor, 100p, 0402, NP0, 5% 50 V                     | Murata |                |
| C173 | C_33P_0402_NP0_J_50  |   |                  | Capacitor, 33p, 0402, NP0, 5%, 50 V                     | Murata |                |
| U201 | T108 IPC+1           |   | Will be supplied | Murata / JTI  | Murata |                |
| C202 | C_100P_0402_NP0_J_50 |   |                  | Capacitor, 100p, 0402, NP0, 5% 50 V                     |        |                |
| C203 | C_1P0_0402_NP0_C_50  |   |                  | Capacitor, 1p, 0402, NP0, $\pm$ 0.25 pF 50 V Murata     | Murata |                |
| C211 | C_10N_0402_X7R_K_25  |   |                  | Capacitor, 10n, 0402, X7R, 10%, 25 V                    | Murata |                |
| C221 | C_47N_0402_X7R_K_25  |   |                  | Capacitor, 47n, 0402, X7R, 10%, 25 V                    | Murata |                |
| C231 | C_1N8_0402_U2J_J_10  |   |                  | Capacitor, 1n8, 0402, U2J, 5%, 10 V                     | Murata |                |
| C251 | C_47N_0402_X7R_K_25  |   |                  | Capacitor, 47n, 0402, X7R, 10%, 25 V                    | Murata |                |
| C261 | C_47N_0402_X7R_K_25  |   |                  | Capacitor, 47n, 0402, X7R, 10%, 25 V                    | Murata |                |
| C271 | C_47N_0402_X7R_K_25  |   |                  | Capacitor, 47n, 0402, X7R, 10%, 25 V                    | Murata |                |
| C281 | C_47N_0402_X7R_K_25  |   |                  | Capacitor, 47n, 0402, X7R, 10%, 25 V                    | Murata |                |
| C291 | C_47N_0402_X7R_K_25  |   |                  | Capacitor, 47n, 0402, X7R, 10%, 25 V                    | Murata |                |
| C301 | C_15P_0402_NP0_J_50  |   |                  | Capacitor, 15p, 0402, NP0, 5%, 50 V                     |        |                |
| C302 | C_0402               | 0 | Do not mount     |   | Murata |                |
| C311 | C_15P_0402_NP0_J_50  |   |                  | Capacitor, 15p, 0402, NP0, 5%, 50 V                     |        |                |
| C321 | C_100N_0402_X5R_K_10 |   | Do not mount     |   |        |                |
| C322 | C_22P_0402_NP0_J_50  |   | Do not mount     |   | Murata |                |
| L1   | L_BEAD_102_0402      | 1 |                  | EMI filter bead, 0402 1k $\Omega$ Tape GHz Band gen use | Murata |                |
| L171 | L_10N_0402_J         | 1 |                  | Inductor, 10n, 0402, $\bar{n}$ 5%                       | Murata |                |
| L204 | L_12N_0402_J         | 1 |                  | Inductor, 12n, 0402, $\bar{n}$ 5%                       | Murata | LQG15HS10NJ02D |
| L205 | L_0402               | 0 | Do not mount     |   | Murata | LQG15HS10NJ02D |
| P1   | SMD_SOCKET_2x10      |   |                  | SMD pinrow socket, .050 spacing, 2x10                   | Samtec |                |
| P2   | SMD_SOCKET_2x10      | 1 |                  | SMD pinrow socket, .050 spacing, 2x10                   | Samtec |                |
| P3   | SMA                  | 1 |                  | SMA connector, straight, through hole                   |        |                |
| R12  | R_0_0402             | 1 |                  | Resistor, 0 $\Omega$ , 0402                             |        |                |
| R141 | R_56K_0402_F         | 1 |                  | Resistor, 56k $\Omega$ , 0402, 1%                       |        |                |

**Table 32. CC1200 EM Rev 1.2.2 920 MHz IPC (continued)**

|      |                      |   |   |                                  |  |      |
|------|----------------------|---|---|----------------------------------|--|------|
| R171 | R_10_0402_J          | 1 |   | Resistor, 10 $\Omega$ , 0402, 5% | Koa  |      |
| R321 | R_0402               | 0 | Do not mount  |                                  |  |      |
| R201 | R_0_0402             | 0 | Do not mount  |                                  |  |      |
| R322 | R_0_0402             | 0 | Do not mount  |                                  |  |      |
| U1   | CC1200               | 1 | TI transceiver  | Texas Instruments                |  |      |
| X1   | X_40.000/10/10/60/10 | 1 | Crystal, 40.000000 MHz, FA-128, 10.0 pF, $\pm 10$ ppm (FT), $\pm 10$ ppm (FS), 60 $\Omega$ max. | Epson Toyocom                    | FA-128, 40MHz, 10PPM, 10PF, 2x1.6mm, -40/+85C, | ACTE |
| X2   | TG_5021CG            | 0 | Do not mount  |                                  |  |      |



## IMPORTANT NOTICE

Texas Instruments Incorporated and its subsidiaries (TI) reserve the right to make corrections, enhancements, improvements and other changes to its semiconductor products and services per JESD46, latest issue, and to discontinue any product or service per JESD48, latest issue. Buyers should obtain the latest relevant information before placing orders and should verify that such information is current and complete. All semiconductor products (also referred to herein as "components") are sold subject to TI's terms and conditions of sale supplied at the time of order acknowledgment.

TI warrants performance of its components to the specifications applicable at the time of sale, in accordance with the warranty in TI's terms and conditions of sale of semiconductor products. Testing and other quality control techniques are used to the extent TI deems necessary to support this warranty. Except where mandated by applicable law, testing of all parameters of each component is not necessarily performed.

TI assumes no liability for applications assistance or the design of Buyers' products. Buyers are responsible for their products and applications using TI components. To minimize the risks associated with Buyers' products and applications, Buyers should provide adequate design and operating safeguards.

TI does not warrant or represent that any license, either express or implied, is granted under any patent right, copyright, mask work right, or other intellectual property right relating to any combination, machine, or process in which TI components or services are used. Information published by TI regarding third-party products or services does not constitute a license to use such products or services or a warranty or endorsement thereof. Use of such information may require a license from a third party under the patents or other intellectual property of the third party, or a license from TI under the patents or other intellectual property of TI.

Reproduction of significant portions of TI information in TI data books or data sheets is permissible only if reproduction is without alteration and is accompanied by all associated warranties, conditions, limitations, and notices. TI is not responsible or liable for such altered documentation. Information of third parties may be subject to additional restrictions.

Resale of TI components or services with statements different from or beyond the parameters stated by TI for that component or service voids all express and any implied warranties for the associated TI component or service and is an unfair and deceptive business practice. TI is not responsible or liable for any such statements.

Buyer acknowledges and agrees that it is solely responsible for compliance with all legal, regulatory and safety-related requirements concerning its products, and any use of TI components in its applications, notwithstanding any applications-related information or support that may be provided by TI. Buyer represents and agrees that it has all the necessary expertise to create and implement safeguards which anticipate dangerous consequences of failures, monitor failures and their consequences, lessen the likelihood of failures that might cause harm and take appropriate remedial actions. Buyer will fully indemnify TI and its representatives against any damages arising out of the use of any TI components in safety-critical applications.

In some cases, TI components may be promoted specifically to facilitate safety-related applications. With such components, TI's goal is to help enable customers to design and create their own end-product solutions that meet applicable functional safety standards and requirements. Nonetheless, such components are subject to these terms.

No TI components are authorized for use in FDA Class III (or similar life-critical medical equipment) unless authorized officers of the parties have executed a special agreement specifically governing such use.

Only those TI components which TI has specifically designated as military grade or "enhanced plastic" are designed and intended for use in military/aerospace applications or environments. Buyer acknowledges and agrees that any military or aerospace use of TI components which have **not** been so designated is solely at the Buyer's risk, and that Buyer is solely responsible for compliance with all legal and regulatory requirements in connection with such use.

TI has specifically designated certain components as meeting ISO/TS16949 requirements, mainly for automotive use. In any case of use of non-designated products, TI will not be responsible for any failure to meet ISO/TS16949.

### Products

|                              |  |
|------------------------------|--|
| Audio                        | <a href="http://www.ti.com/audio">www.ti.com/audio</a>                               |
| Amplifiers                   | <a href="http://amplifier.ti.com">amplifier.ti.com</a>                               |
| Data Converters              | <a href="http://dataconverter.ti.com">dataconverter.ti.com</a>                       |
| DLP® Products                | <a href="http://www.dlp.com">www.dlp.com</a>   |
| DSP                          | <a href="http://dsp.ti.com">dsp.ti.com</a>   |
| Clocks and Timers            | <a href="http://www.ti.com/clocks">www.ti.com/clocks</a>                             |
| Interface                    | <a href="http://interface.ti.com">interface.ti.com</a>                               |
| Logic                        | <a href="http://logic.ti.com">logic.ti.com</a>                                       |
| Power Mgmt                   | <a href="http://power.ti.com">power.ti.com</a>                                       |
| Microcontrollers             | <a href="http://microcontroller.ti.com">microcontroller.ti.com</a>                   |
| RFID                         | <a href="http://www.ti-rfid.com">www.ti-rfid.com</a>                                 |
| OMAP Applications Processors | <a href="http://www.ti.com/omap">www.ti.com/omap</a>                                 |
| Wireless Connectivity        | <a href="http://www.ti.com/wirelessconnectivity">www.ti.com/wirelessconnectivity</a> |

### Applications

|                               |  |
|-------------------------------|--|
| Automotive and Transportation | <a href="http://www.ti.com/automotive">www.ti.com/automotive</a>                         |
| Communications and Telecom    | <a href="http://www.ti.com/communications">www.ti.com/communications</a>                 |
| Computers and Peripherals     | <a href="http://www.ti.com/computers">www.ti.com/computers</a>                           |
| Consumer Electronics          | <a href="http://www.ti.com/consumer-apps">www.ti.com/consumer-apps</a>                   |
| Energy and Lighting           | <a href="http://www.ti.com/energy">www.ti.com/energy</a>                                 |
| Industrial                    | <a href="http://www.ti.com/industrial">www.ti.com/industrial</a>                         |
| Medical                       | <a href="http://www.ti.com/medical">www.ti.com/medical</a>                               |
| Security                      | <a href="http://www.ti.com/security">www.ti.com/security</a>                             |
| Space, Avionics and Defense   | <a href="http://www.ti.com/space-avionics-defense">www.ti.com/space-avionics-defense</a> |
| Video and Imaging             | <a href="http://www.ti.com/video">www.ti.com/video</a>                                   |

### TI E2E Community

[e2e.ti.com](http://e2e.ti.com)