

CC13xx Antenna Diversity

ABSTRACT

This application report describes a preamble quality-based antenna-diversity patch for the CC13xx SimpleLink™ Sub-1 GHz ultra-low power wireless microcontroller (MCU).

Recommended register settings discussed in this application report can be downloaded from <http://www.ti.com/lit/zip/SWRA523>.

Contents

1	Introduction	2
2	Antenna Diversity Patch	2
3	Building a Software Example.....	6
4	Measurement Results	8
5	References	15

List of Figures

1	Antenna Diversity Flow Chart	3
2	SmartRF™ Studio Setup for TX	7
3	PER vs Input Power Level (6-Byte Preamble, 6-dB Attenuator on One Antenna).....	8
4	PER vs Input Power Level (8-Byte Preamble, 6-dB Attenuator on One Antenna).....	9
5	PER vs Input Power Level (6-Byte Preamble, 6-dB Attenuator on One Antenna).....	9
6	PER vs Input Power Level (8-Byte Preamble, 6-dB Attenuator on One Antenna)	10
7	Block Diagram of Antenna Diversity Test Setup	11
8	Antenna Diversity Test Board.....	12

List of Tables

1	Register Overrides to be Removed from SmartRF™ Studio Code Export.....	4
2	Register Override to be Added to the SmartRF™ Studio Code Export	4
3	Configuration Registers	5
4	Status Registers	5
5	Typical 1% BER Sensitivity (20% PER, 3-Byte Payload)	8
6	Test 1 PER for Boards Using ANT1, ANT2, or Diversity (DIV)	13
7	Test 2 PER for Boards using ANT1, ANT2, or Diversity (DIV).....	13
8	Test 3 PER for Boards Using ANT1, ANT2, or Diversity (DIV)	14
9	Test 4 PER for Boards Using ANT1, ANT2, or Diversity (DIV)	14

Trademarks

SimpleLink, SmartRF are trademarks of Texas Instruments.
 ARM, Cortex are registered trademarks of ARM Limited (or its subsidiaries).
 All other trademarks are the property of their respective owners.

1 Introduction

Multipath is a phenomenon that occurs when electromagnetic waves bounce off of surfaces (such as floors, ceilings, walls, trees, people walking by, and so on) and arrive at the receiver at different times. When these signals arrive at the receiver out-of-phase, they may result in a form of cancellation called *fading*.

Antenna diversity is a technique that can be used to improve radio communication and maximize the chance of a packet getting through at a given time and in a given position between a receiver and transmitter in a nonstatic environment.

This application report presents a brief description of the patch, relevant status registers, configuration registers, and required overrides. Performance figures (when using the patch with CC1310) are provided with real-world measurement results that show the benefit of antenna diversity.

All measurements were performed on the CC13xxEM-7793_4L reference design [1].

2 Antenna Diversity Patch

Antenna diversity is not available in ROM code, and a patch is required to support this feature.

The antenna diversity feature can be used only with the proprietary radio commands. The patch is part of the SimpleLink™ CC13x0 Software Development Kit [3] and recommended settings and overrides are covered in [Section 2.3](#), [Section 2.4](#) and [Section 2.5](#).

2.1 Preamble-Based Antenna Diversity With External Switch

The antenna diversity algorithm controls an external antenna using an internal signal from the RF Core (RFC_SMI_CL_OUT). The RFC_SMI_CL_OUT signal can be routed to any available digital I/O (DIO). [Section 3](#) describes how this signal is routed out on a DIO.

The antenna diversity algorithm is based on Preamble Quality Threshold (PQT), meaning that it searches for a preamble. If there is no preamble the algorithm toggles the external switch and starts over again. If a preamble is detected, the algorithm toggles the switch and checks if a preamble is also present at the other antenna. If a preamble is found on both antennas, the algorithm selects the antenna with highest RSSI and then starts searching for a sync word. If a preamble is found on the first antenna only, it toggles the switch back again and starts searching for a sync word on the first antenna. [Figure 1](#) shows the state machine diagram.

To improve the robustness of preamble detection, an additional carrier-sense qualifier check is added before the preamble is accepted. This feature can be turned on or turned off (see [Section 2.5](#)).

The carrier sense (CS) threshold is set to -111 dBm. In an environment with a noise floor above -111 dBm, it is advantageous to increase the CS threshold to reduce the likelihood of processing a false packet. If the CC13xx device is preoccupied by processing a false packet, there is a finite possibility that a true packet will be missed. [Section 2.5](#) explains how to change the CS threshold.

If the RF Core is not power cycled, the last antenna used by the radio will be used the next time it enters the TX state. This condition ensures that an acknowledgment is sent with the same antenna that received the last packet.

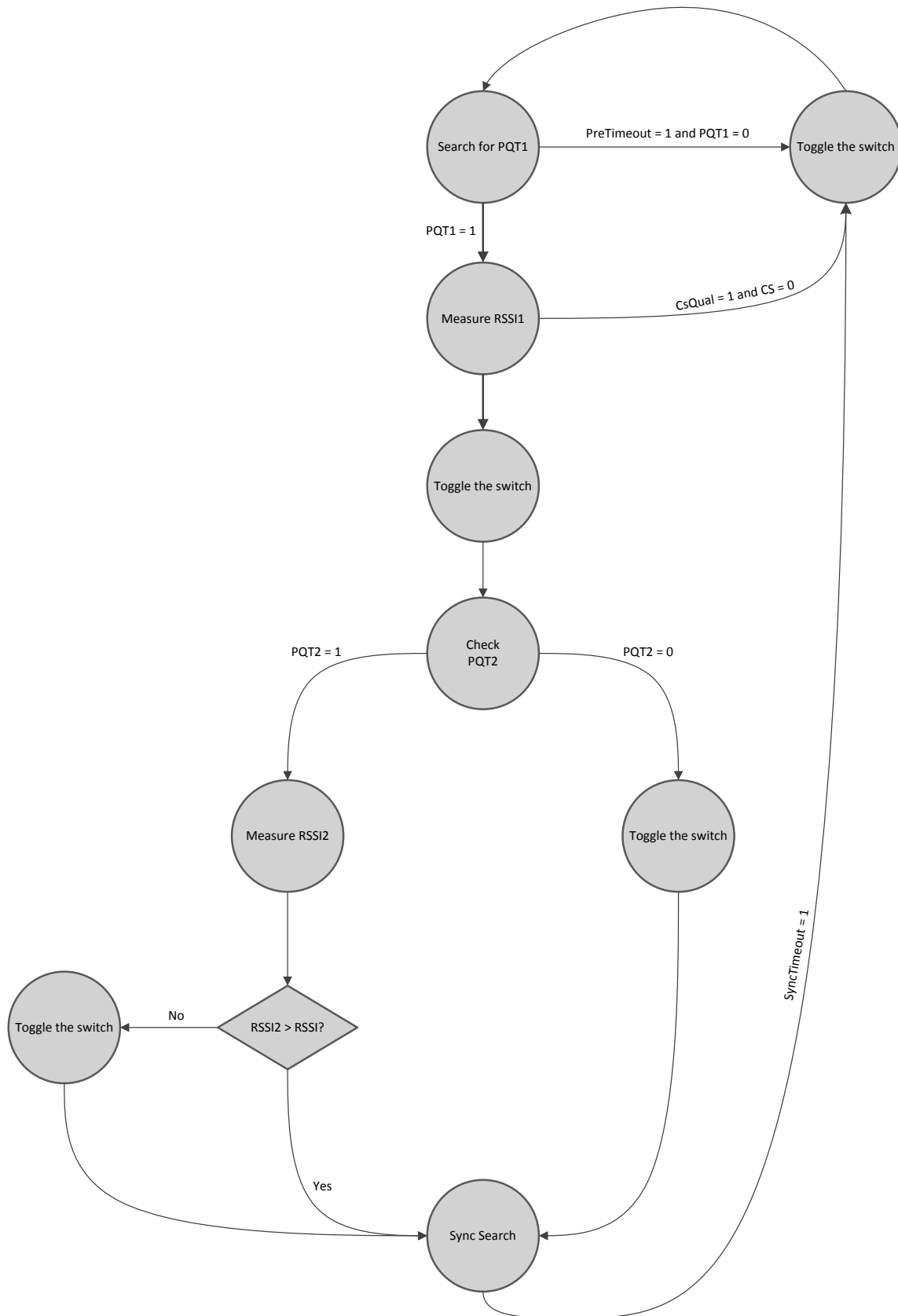

Figure 1. Antenna Diversity Flow Chart

2.2 Automatic Gain Control (AGC)

The antenna diversity algorithm has a dedicated automatic gain control (AGC) (ANT_DIV AGC).

There is no gain adjustment during a preamble search. The AGC performs one front-end gain adjustment when entering the Sync Search state (see [Figure 1](#)) and then uses the RSSI from the selected antenna to calculate the optimal RF gain setting.

The user can change the signal level where the AGC starts to reduce the front-end gain by programming the AGC RSSI reference level (*AgcRssiRef*) (see [Table 3](#)). The AGC uses the measured RSSI and the programmed RSSI reference level to calculate the AGC_ERROR and optimum RF gain level, as shown in [Equation 1](#).

$$\text{AGC_ERROR} = \text{RSSI} - \text{AgcRssiRef_dBm} \quad (1)$$

2.3 Recommended Operating Limits

The antenna diversity algorithm is flexible when it comes to data rate, but has a limitation related to the minimum preamble length. [Equation 2](#) shows the calculation for the minimum preamble length.

$$\text{Minimum Preamble Length} = 4 \times \text{PreTimeout} + 8 \text{ [symbols]} \quad (2)$$

The worst-case scenario occurs when a signal is received at the sensitivity level. For example, if the first antenna misses the desired preamble and the signal level is too low for the second antenna, two preamble time-outs have occurred without receiving a preamble hit. Then the receiver gets a preamble hit and must check the other antenna. This is the theory behind the worst-case scenario of 4-preamble time-outs. In addition, it is necessary to add the internal hardware delay.

Thus, for the default setting with *PreTimeout* = 10 symbols, the minimum preamble length is 6 bytes.

Because there is no AGC during antenna switching, the algorithm might not select the antenna with highest RSSI if both antenna signals are above approximately -50 dBm.

2.4 Register Overrides

SmartRF™ Studio [\[2\]](#) should be used to generate the register settings. However, three of the radio register settings from the SmartRF Studio must be removed (see [Table 1](#)) when using the antenna diversity patch and one must be added (see [Table 2](#)).

Table 1. Register Overrides to be Removed from SmartRF™ Studio Code Export

Override	Comment
HW_REG_OVERRIDE(0x6084,0xXXXX)	Remove from SmartRF Studio code export
HW_REG_OVERRIDE(0x6088,0xXXXX)	Remove from SmartRF Studio code export
HW_REG_OVERRIDE(0x608C,0xXXXX)	Remove from SmartRF Studio code export

[Table 2](#) lists the radio register settings from the SmartRF Studio that must be changed to use the antenna diversity patch.

Table 2. Register Override to be Added to the SmartRF™ Studio Code Export

Override	Comment
MCE_RFE_OVERRIDE(1, 0, 0, 1, 0, 0)	Run the MCE and RFE patches

[\[4\]](#) contains a smartrf_settings.c file that has the complete override list to be used with the patch.

2.5 Configuration Registers

Table 3 lists the configuration registers available in the antenna diversity patch.

Table 3. Configuration Registers

Register	Bits	Name	Description	Default
0x4004 52B0	15–8	PreTimeout	PreTimeout_bits = PreTimeout + 8	0x02
	7–0	SyncTimeout	SyncTimeout_bits = SyncBits + PreamBits + SyncTimeout – 31	0x18
0x4004 52B4	15	NA	NA	0x00
	14	CsQual	Carrier sense qualified preamble	0x01
	13–12	NA	NA	0x00
	11–8	PreLen	Number of preamble bits for correlation PreLen_bits = PreLen + 1	0x07
	7–0	PreThr	Preamble correlation threshold	0x0B
0x4004 6088	15–0	AgcRssiRef	AGC RSSI reference level for gain adjustment AgcRssiRef_dBm = AgcRssiRef – 2 ¹⁶ [dBm]	0xFFA6
0x4004 6090	15–8	Reserved		0x0A
	7–0	CS_THR	Carrier sense threshold CS_THR_dBm = CS_THR – 256 [dBm]	0x91

This register can only be changed by static overrides of the following format:

```
HW_REG_OVERRIDE(0xXXXX, 0xYYYY),
```

where:

- XXXX is the 2 least significant bytes of the register address (52B0, 52B4, 6088, or 6090)
- YYYY is the value to write

As an example, the following register write sets the carrier sense threshold to –111 dBm:

```
HW_REG_OVERRIDE(0x6090, 0x0A91),
```

Increasing the carrier threshold to –107 dBm (for example) yields the following:

```
HW_REG_OVERRIDE(0x6090, 0x0A95),
```

2.6 Status Registers

Table 4 lists the status registers available in the antenna diversity patch.

Table 4. Status Registers

Register	Bits	Name	Description	Default
0x4004 5178	15–0	AntSelect	Antenna selection TX and RX 0: Antenna0 1: Antenna1	0x00
0x4004 517C	15–8	RSSI1	RSSI antenna 1	0x00
	7–0	RSSI0	RSSI antenna 0	0x00
0x4004 51C8	11–0	AntSelect0Cnt	Antenna select 0 counter	0x00
0x4004 51CC	11–0	AntSelect1Cnt	Antenna select 1 counter	0x00

In TX, the *AntSelect* selects the antenna that is used for the transmission. The configuration registers do not have retention, so if the RF Core is power cycled, the application must then update the *AntSelect* register. The ARM® Cortex®-M3 processor must read the register value before power cycling the RF Core, and then the processor must write the register value again before entering TX.

The registers can be read using the CMD_READ_RFREG API command but can be written only as an override (when doing a CMD_PROP_RADIO_DIV_SETUP).

3 Building a Software Example

Using the patch is transparent to the application as long as the correct settings are used and the RFC_SMI_CL_OUT signal is output on the DIO used to control the switch.

As an example, the following steps must be completed to implement antenna diversity on the rfPacketRX example. The rfPacketRX example is available when downloading the SimpleLink™ CC13x0 Software Development Kit [3]. See the Proprietary RF Quick Start Guide for more information. A link to this guide can be found in the documentation_overview_simplelink_cc13x0_sdk.html found here:

C:\ti\simplelink_cc13x0_sdk_x_xx_xx_xx\docs (assuming that installation has been to default location)

1. The smartrf_settings.c file must be replaced with the one included with this document [4].
2. The following defines must be added:

```
#define PINCC26XX_MUX_RFC_SMI_CL_OUT 0x37
#define ANTENNA_SELECT                IOID_X
#define ANTENNA_SELECT_INV            IOID_Y // Added if the switch requires two control signals
```

3. The ANTENNA_SELECT and optional ATENNA_SELECT_INV signals must be added to the pinTable:

```
PIN_Config pinTable[] =
{
    Board_LED1          | PIN_GPIO_OUTPUT_EN | PIN_GPIO_LOW | PIN_PUSHPULL | PIN_DRVSTR_MAX,
    ANTENNA_SELECT      | PIN_GPIO_OUTPUT_EN | PIN_GPIO_LOW | PIN_PUSHPULL | PIN_DRVSTR_MAX,
    ANTENNA_SELECT_INV | PIN_GPIO_OUTPUT_EN | PIN_GPIO_LOW | PIN_PUSHPULL | PIN_DRVSTR_MAX |
    PIN_INV_INOUT,
    PIN_TERMINATE
};
```

4. Add the following line or lines to the int main(void) function before starting the BIOS. Adding these lines is to connect the RFC_SMI_CL_OUT signal to wanted DIOs (ANTENNA_SELECT and ANTENNA_SELECT_INV).

```
PINCC26XX_setMux(pinHandle, PIN_ID(ANTENNA_SELECT), PINCC26XX_MUX_RFC_SMI_CL_OUT);
PINCC26XX_setMux(pinHandle, PIN_ID(ANTENNA_SELECT_INV), PINCC26XX_MUX_RFC_SMI_CL_OUT);
```

For the transmitter, use the SmartRF Studio and the 50-kbps setting with the preamble count set to 6 bytes (see Figure 2).

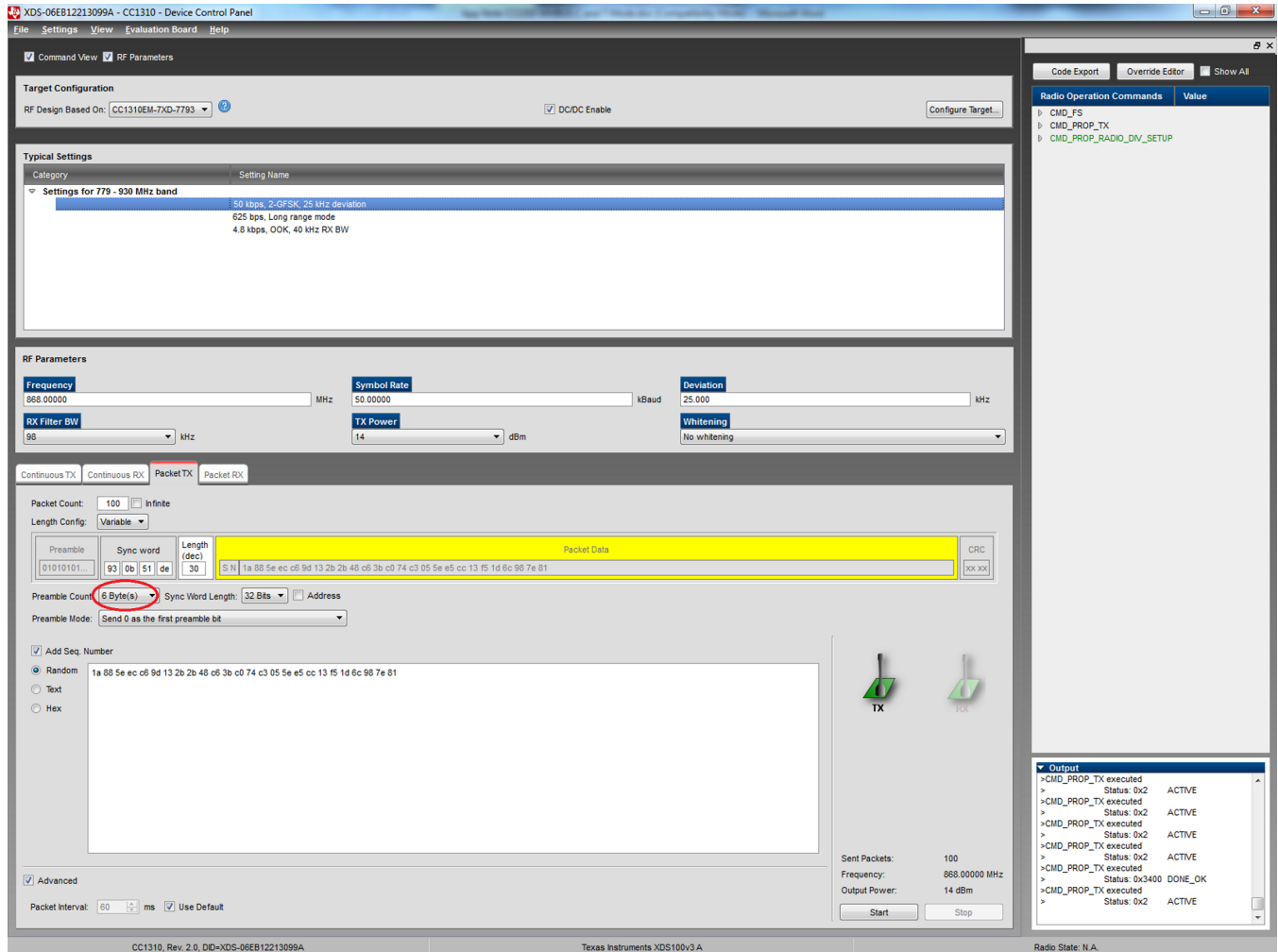

Figure 2. SmartRF™ Studio Setup for TX

4 Measurement Results

4.1 System Parameters

The system parameters used when testing the antenna diversity patch are as follows:

- 2-GFSK modulation
- 50-kbps data rate, ± 25 kHz deviation
- 868 MHz
- 6- or 8-byte preamble
- 4-byte sync word (0x930B 51DE)
- Carrier sense (CS) threshold set to -111 dBm

4.2 Conducted Measurements

4.2.1 Sensitivity

Table 5 lists the sensitivity measurement results.

Table 5. Typical 1% BER Sensitivity (20% PER, 3-Byte Payload)

Preamble Length	Typical Sensitivity [dBm]
6 bytes	-109
8 bytes	-109

4.2.2 Packet Error Rate (PER) versus Input Power Level

A 20% PER corresponds to a 1% bit error rate (BER).

4.2.2.1 6-Byte Preamble

Figure 3 shows the PER versus the input power level with a 6-byte preamble and a 6-dB attenuator on one antenna.

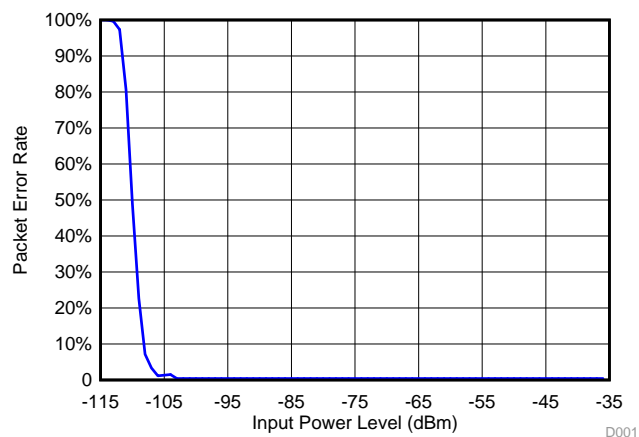

Figure 3. PER vs Input Power Level (6-Byte Preamble, 6-dB Attenuator on One Antenna)

4.2.2.2 8-Byte Preamble

Figure 4 shows the PER versus the input power level with an 8-byte preamble and a 6-dB attenuator on one antenna.

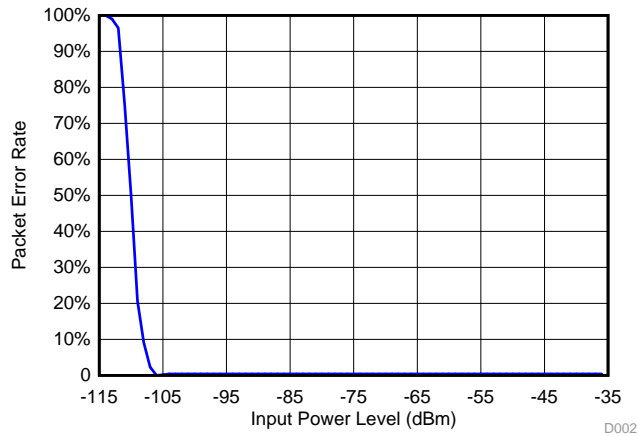

Figure 4. PER vs Input Power Level (8-Byte Preamble, 6-dB Attenuator on One Antenna)

4.2.3 PER versus Frequency Offset

4.2.3.1 6-Byte Preamble

Figure 5 shows the PER versus the input power level with a 6-byte preamble and a 6-dB attenuator on one antenna.

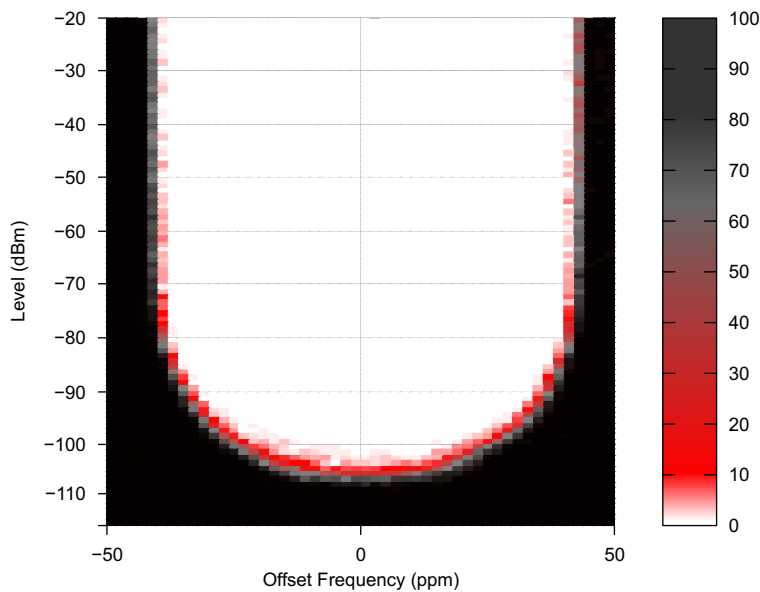
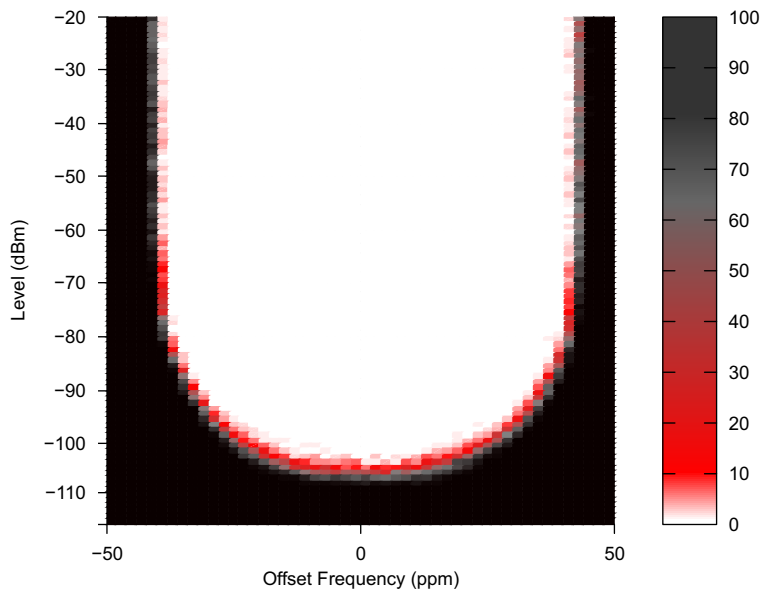

Figure 5. PER vs Input Power Level (6-Byte Preamble, 6-dB Attenuator on One Antenna)

4.2.3.2 8-Byte Preamble

Figure 6 shows the PER versus the input power level with an 8-byte preamble and a 6-dB attenuator on one antenna.



**Figure 6. PER vs Input Power Level
(8-Byte Preamble, 6-dB Attenuator on One Antenna)**

4.3 Radiated Measurement Results

4.3.1 Hardware Setup

Testing was conducted with the following:

- One transmitter
- Three receivers
- Two antennas (ANT1 and ANT2)

The hardware test setup allows an antenna diversity solution to be compared with a single-antenna solution at the same time and with the same fading conditions.

The three receivers were in RX mode at the same time. The hardware test setup allows comparison of an antenna-diversity solution with a single-antenna solution at the same time and with the same fading conditions. [Figure 7](#) shows a block diagram of the test setup and [Figure 8](#) shows the test board.

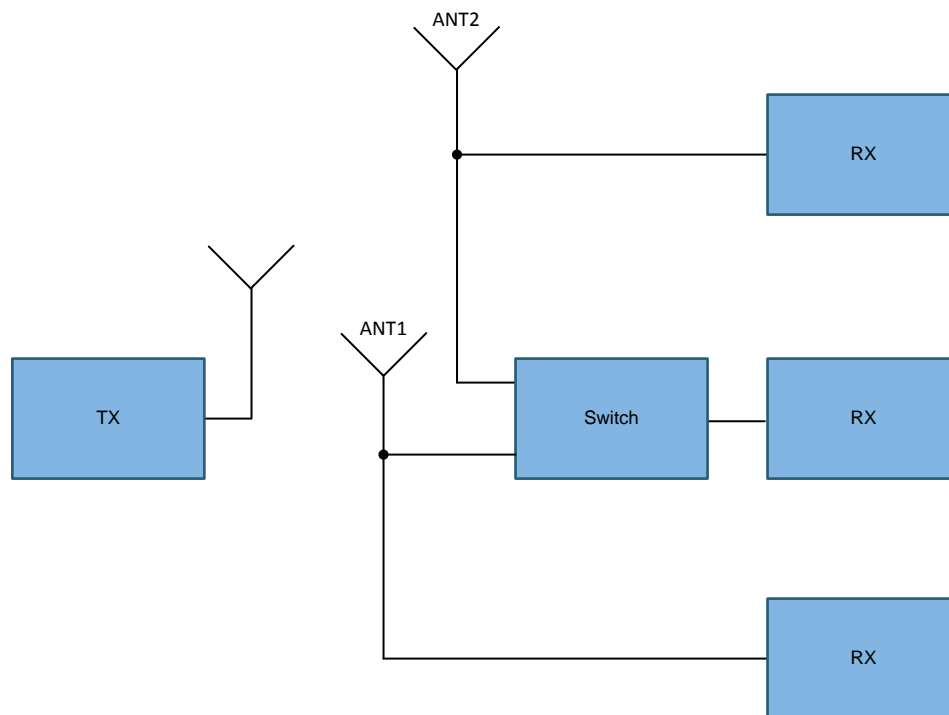

Figure 7. Block Diagram of Antenna Diversity Test Setup

Notes with reference to [Figure 8](#):

- A CC1310EM is connected to the left antenna (ANT1) through a splitter. This RX board does not use the antenna diversity patch.
- A second CC1310EM is connected to the right antenna (ANT2) through a splitter. This RX board does not use the antenna diversity patch.
- A third CC1310EM is connected to both antennas (DIV) through a switch and splitters. This RX board uses the antenna patch.
- A CC1310EM is used as a transmitter.
- The antenna feed points are placed a distance of $\lambda/4$ apart.
- The antennas are placed at right angles to each other.
- Control signals for the switch are made available on two of the CC1310 DIOs and are used to select the appropriate antenna through the switch.

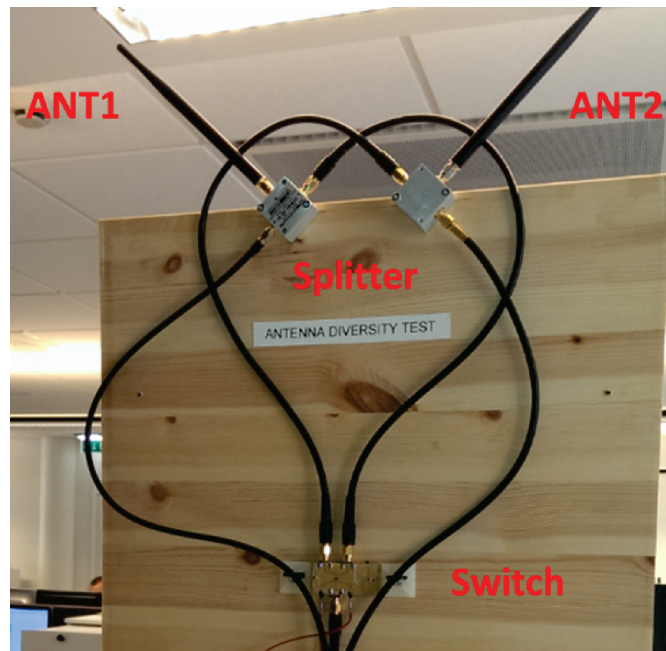

Figure 8. Antenna Diversity Test Board

4.3.2 Software Setup

For the board running the antenna diversity patch, we modified the `rfPacketRx` example as described in [Section 3](#). In addition, a check was made in the callback function to determine on which antenna the packet was received. This check was done by reading `AntSelect` from the 0x4004 5178 register (see [Table 4](#)).

The following code was used to read the register and to track the number of packets that were received on each antenna:

```
RF_Stat status = RF_runImmediateCmd(rfHandle, (uint32_t*)&RF_cmdReadRfRegAntenna);
if (((uint8_t)(RF_cmdReadRfRegAntenna.value)) & 0x01)
{
    antennal++;
}
else
{
    antenna0++;
}

// RF_cmdReadRfRegAntenna was configured as follows:
rfc_CMD_READ_RFREG_t RF_cmdReadRfRegAntenna =
{
    .commandNo = 0x0601,
    .address = 0x5178,
};
```

`AntSelect` is read instead of `AntSelect0Cnt` and `AntSelect1Cnt` because during testing, we were interested only in the selected antenna for the packets we received (`AntSelect0Cnt` and `AntSelect1Cnt` would include antenna selection in cases where packets were discarded due to CRC errors).

4.3.3 Test 1

The TX board was placed in a fixed location in the TI office in Oslo. The RX boards were placed one floor higher with walls between the TX and RX boards (fixed obstacles). People were walking between the TX and RX boards (obstacles moving in and out). For the TX board, a 60-dB attenuator was connected between the SMA connector on the CC1310EM and the antenna (that is, a transmitted power level of 14 dBm – 60 dB = –46 dBm). [Table 6](#) lists the PER for Test 1.

Table 6. Test 1 PER for Boards Using ANT1, ANT2, or Diversity (DIV)

Antenna	Number of Received Packets	Number of Sent Packets	PER [%]
ANT1	2647	3000	11.8
ANT2	2078	3000	30.7
DIV	2672	3000	10.9

The board using antenna diversity (DIV) and the board connected to ANT1 yielded the same PER. The CC1310EM connected to ANT2 yielded a higher PER.

4.3.4 Test 2

Test 2 is the same as Test 1, but the antenna diversity test board was rotated by 90 degrees. [Table 7](#) lists the PER for Test 2.

Table 7. Test 2 PER for Boards using ANT1, ANT2, or Diversity (DIV)

Antenna	Number of Received Packets	Number of Sent Packets	PER [%]
ANT1	632	3000	78.9
ANT2	2696	3000	10.1
DIV	2751	3000	8.3

The board using antenna diversity (DIV) and the board connected to ANT2 yielded the same PER. The CC1310EM connected to ANT1 yielded a significantly higher PER.

4.3.5 Test 3

Test 3 is the same as Test 2, but with a different TX output power level to see how much the power level had to be increased for a system not using antenna diversity to achieve the same PER as a system using antenna diversity. [Table 8](#) lists the PER for Test 3.

Table 8. Test 3 PER for Boards Using ANT1, ANT2, or Diversity (DIV)

Antenna	Output Power [dBm]	Number of Received Packets	Number of Sent Packets	PER [%]
ANT1	-46	632	3000	78.9
	-42	1551	2000	22.5
	-38	1971	2000	1.5
ANT2	-46	2696	3000	10.1
	-42	1900	2000	5.0
	-38	1983	2000	0.8
DIV	-46	2751	3000	8.3
	-42	1944	2000	2.8
	-38	1999	2000	0

In this test, an increase in TX power of approximately 4 dB was required to achieve the same PER for the board connected to ANT1 as for the board using antenna diversity (-38 dBm versus -42 dBm, respectively).

4.3.6 Test 4

The RX boards were placed in a fixed location. The TX board was carried around the TI office. [Table 9](#) lists the PER for Test 4.

Table 9. Test 4 PER for Boards Using ANT1, ANT2, or Diversity (DIV)

Antenna	Number of Received Packets	Number of Sent Packets	PER [%]
ANT1	2055	3000	31.5
ANT2	2114	3000	29.5
DIV	2403	3000	19.9

The board using antenna diversity (DIV) yielded a lower PER than the single-antenna boards (ANT1 and ANT2).

5 References

1. Texas Instruments, [CC13xxEM-7793_4L](#), Reference Design
2. Texas Instruments, [SmartRF Studio 7](#)
3. Texas Instruments, [SimpleLink™ CC13x0 Software Development Kit](#)
4. Texas Instruments, [SWRA523](#) (.zip file with recommended settings and overrides)

Revision History

NOTE: Page numbers for previous revisions may differ from page numbers in the current version.

Changes from December 23, 2016 to March 31, 2017	Page
• Added SDK and reference information to Section 2	2
• Added file reference information to Section 2.4	4
• Deleted patch storage information from Section 3	6

Changes from September 2, 2016 to December 23, 2016	Page
• Changed Section 5	15

IMPORTANT NOTICE FOR TI DESIGN INFORMATION AND RESOURCES

Texas Instruments Incorporated ("TI") technical, application or other design advice, services or information, including, but not limited to, reference designs and materials relating to evaluation modules, (collectively, "TI Resources") are intended to assist designers who are developing applications that incorporate TI products; by downloading, accessing or using any particular TI Resource in any way, you (individually or, if you are acting on behalf of a company, your company) agree to use it solely for this purpose and subject to the terms of this Notice.

TI's provision of TI Resources does not expand or otherwise alter TI's applicable published warranties or warranty disclaimers for TI products, and no additional obligations or liabilities arise from TI providing such TI Resources. TI reserves the right to make corrections, enhancements, improvements and other changes to its TI Resources.

You understand and agree that you remain responsible for using your independent analysis, evaluation and judgment in designing your applications and that you have full and exclusive responsibility to assure the safety of your applications and compliance of your applications (and of all TI products used in or for your applications) with all applicable regulations, laws and other applicable requirements. You represent that, with respect to your applications, you have all the necessary expertise to create and implement safeguards that (1) anticipate dangerous consequences of failures, (2) monitor failures and their consequences, and (3) lessen the likelihood of failures that might cause harm and take appropriate actions. You agree that prior to using or distributing any applications that include TI products, you will thoroughly test such applications and the functionality of such TI products as used in such applications. TI has not conducted any testing other than that specifically described in the published documentation for a particular TI Resource.

You are authorized to use, copy and modify any individual TI Resource only in connection with the development of applications that include the TI product(s) identified in such TI Resource. NO OTHER LICENSE, EXPRESS OR IMPLIED, BY ESTOPPEL OR OTHERWISE TO ANY OTHER TI INTELLECTUAL PROPERTY RIGHT, AND NO LICENSE TO ANY TECHNOLOGY OR INTELLECTUAL PROPERTY RIGHT OF TI OR ANY THIRD PARTY IS GRANTED HEREIN, including but not limited to any patent right, copyright, mask work right, or other intellectual property right relating to any combination, machine, or process in which TI products or services are used. Information regarding or referencing third-party products or services does not constitute a license to use such products or services, or a warranty or endorsement thereof. Use of TI Resources may require a license from a third party under the patents or other intellectual property of the third party, or a license from TI under the patents or other intellectual property of TI.

TI RESOURCES ARE PROVIDED "AS IS" AND WITH ALL FAULTS. TI DISCLAIMS ALL OTHER WARRANTIES OR REPRESENTATIONS, EXPRESS OR IMPLIED, REGARDING TI RESOURCES OR USE THEREOF, INCLUDING BUT NOT LIMITED TO ACCURACY OR COMPLETENESS, TITLE, ANY EPIDEMIC FAILURE WARRANTY AND ANY IMPLIED WARRANTIES OF MERCHANTABILITY, FITNESS FOR A PARTICULAR PURPOSE, AND NON-INFRINGEMENT OF ANY THIRD PARTY INTELLECTUAL PROPERTY RIGHTS.

TI SHALL NOT BE LIABLE FOR AND SHALL NOT DEFEND OR INDEMNIFY YOU AGAINST ANY CLAIM, INCLUDING BUT NOT LIMITED TO ANY INFRINGEMENT CLAIM THAT RELATES TO OR IS BASED ON ANY COMBINATION OF PRODUCTS EVEN IF DESCRIBED IN TI RESOURCES OR OTHERWISE. IN NO EVENT SHALL TI BE LIABLE FOR ANY ACTUAL, DIRECT, SPECIAL, COLLATERAL, INDIRECT, PUNITIVE, INCIDENTAL, CONSEQUENTIAL OR EXEMPLARY DAMAGES IN CONNECTION WITH OR ARISING OUT OF TI RESOURCES OR USE THEREOF, AND REGARDLESS OF WHETHER TI HAS BEEN ADVISED OF THE POSSIBILITY OF SUCH DAMAGES.

You agree to fully indemnify TI and its representatives against any damages, costs, losses, and/or liabilities arising out of your non-compliance with the terms and provisions of this Notice.

This Notice applies to TI Resources. Additional terms apply to the use and purchase of certain types of materials, TI products and services. These include; without limitation, TI's standard terms for semiconductor products (<http://www.ti.com/sc/docs/stdterms.htm>), [evaluation modules](#), and [samples](http://www.ti.com/sc/docs/sampterm.htm) (<http://www.ti.com/sc/docs/sampterm.htm>).

Mailing Address: Texas Instruments, Post Office Box 655303, Dallas, Texas 75265
Copyright © 2017, Texas Instruments Incorporated