

Current Savings in CC254x Using the TPS62730

By Abhishek Chattopadhyay

Keywords

- *Bluetooth Low Energy*
- *BLE*
- *Power Consumption*
- *DC/DC*
- *TPS62730*
- *Battery Life*
- *CC2540MINI-DK*
- *CC2540*
- *CC2541*
- *CC254x*

1 Introduction

The CC254x family of devices operates between 2.0V and 3.6V. Internally, the supply is generally regulated down to 1.8V using LDOs. This means that for systems with high supply voltages, much of the energy is lost in the LDOs. To remedy this, an external DC/DC can be used to regulate down to ~2V and increase the overall efficiency of the system. There are two main challenges that need to be addressed with this design:

- The quiescent current of DC/DC solutions dictate that they have to be powered down during the lowest power modes (PM2/3). It is a design challenge to have a microcontroller switch on and off its own power supply.
- The DC/DC introduces switching noise on the power supply. This may adversely affect RF performance and make it difficult to pass RF regulations.

The TPS62730 is a high frequency synchronous step down DC-DC converter optimized for low power wireless applications.

The purpose of this design is to both make a test platform to enable us to characterize the solution while at the same time serving as a reference design and development platform for our customers. The goal of this design should be to make and characterize a solution that gives reduced peak and average current consumption in high supply voltage applications while maintaining good RF performance and passing regulations.

All measurements are presented in this application note is based on the CC2540+TPS62730EM [3] and CC2541+TPS62730EM [7].

Note that the results presented in this document are intended as a guideline only.

Table of Contents

KEYWORDS	1
1 INTRODUCTION	1
2 ABBREVIATIONS	2
3 POWER CONCEPT	3
3.1 EXISTING POWER CONCEPT.....	3
3.2 NEW POWER CONCEPT.....	3
4 TPS62730 (TPS RADIO)	4
5 CC254X + TPS62730 REFERENCE DESIGN	5
5.1 ON/BYP MODE SELECTION.....	5
5.2 START UP.....	5
5.3 AUTOMATIC TRANSITION FROM DC/DC TO BYPASS OPERATION.....	5
6 CURRENT	7
6.1 RECEIVE CURRENT.....	7
6.2 RECEIVE CURRENT COMPARISON (STANDARD GAIN).....	7
6.3 TRANSMIT CURRENT.....	9
6.4 TRANSMIT CURRENT COMPARISON (0 DBM).....	9
6.5 CONNECTION EVENT.....	11
7 RF PERFORMANCE	13
7.1 RECEIVE SENSITIVITY AND SATURATION OF THE CC2540.....	13
7.2 TRANSMIT POWER OF THE CC2540.....	14
7.3 TX SPECTROGRAM OF THE CC2540.....	16
7.4 RECEIVE SENSITIVITY AND SATURATION OF THE CC2541.....	17
7.5 TRANSMIT POWER OF THE CC2541.....	18
7.6 TX SPECTROGRAM OF THE CC2541.....	20
7.7 CONCLUSION.....	21
8 REFERENCES	22
9 GENERAL INFORMATION	23
9.1 DOCUMENT HISTORY.....	23

2 Abbreviations

EM	Evaluation module
BLE	<i>Bluetooth</i> low energy
DC	Direct current
DK	Development kit
PM2	Power mode 2
RF	Radio frequency
RX	Receive
TX	Transmit
LDO	Low Drop Out regulator
SG	Standard Gain
HG	High Gain
XOSC	Crystal Oscillator
RCOSC	RC Oscillator

3 Power Concept

The CC254x can be run off of batteries with a voltage range of 2.0V to 3.6V. The internal LDOs in the CC254x regulate the supply voltage to 1.8V. At high battery voltage the efficiency takes a hit as a large amount of the battery is wasted on the LDOs. The TPS62730 can convert from 1.9V to 3.9V to a desired voltage. In the case of our application we found 2.2V as a voltage above which the DC/DC switching frequency does not affect the RF performance of the CC254x. When the supply voltage to the DC/DC falls below 2.2V, the TPS62730 automatically enters into bypass mode, where the output of the TPS62730 is directly connected to the battery. Thus incorporating the TPS62730 with the CC254x allows for increased efficiency of the above system.

3.1 Existing Power Concept

Currently the CC254x and peripherals on the EM are directly run of the battery voltage. Internally, the supply is generally regulated down to 1.8V using LDOs. This means that for systems with high supply voltages, much of the energy is lost in the LDOs.

3.2 New Power Concept

In the new power concept, the CC254x and peripherals will be run off the TPS62730. The DC/DC steps the battery voltage to 2.1V when the chip is active mode and bypasses the supply to the chip and peripherals when the chip is in sleep mode. This reduces the current consumption during the active mode of the chip, which insures improved battery life.

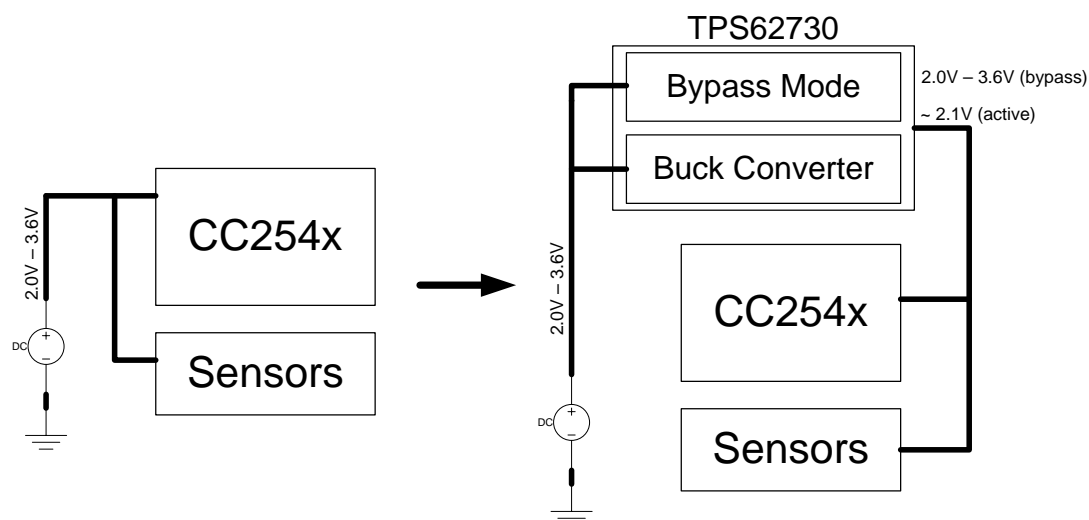

Figure 1. Power Concept

4 TPS62730 (TPS Radio)

The TPS62730 [1] features an Ultra Low Power bypass mode with typical 30nA current consumption to support sleep and low power modes of modern RF transceivers such as the CC2540. In this bypass mode, the output capacitor of the TPS62730 converter is connected via an integrated typ. 2.1 ohm Bypass switch to the battery.

In TPS62730 operation mode the device provides a regulated output voltage consuming typical 25µA quiescent current. With a switch frequency up to 3MHz, the TPS62730 features low output ripple voltage and low noise even with a small 2.2µF output capacitor. The automatic transition into bypass mode during DC/DC operation prevents an increase of output ripple voltage and noise once the DC/DC converter operates close to 100% duty cycle mode. The device automatically enters bypass mode once the battery voltage falls below the automatic bypass switch transition threshold.

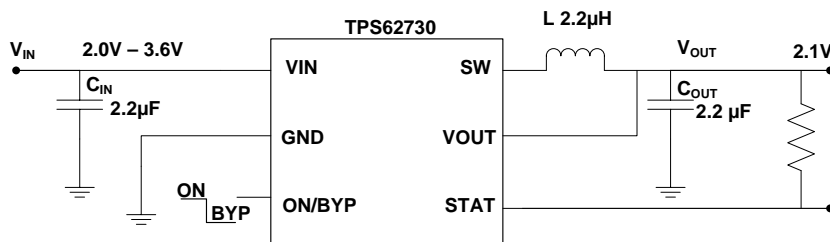

Figure 2. TPS62730 typical application circuit

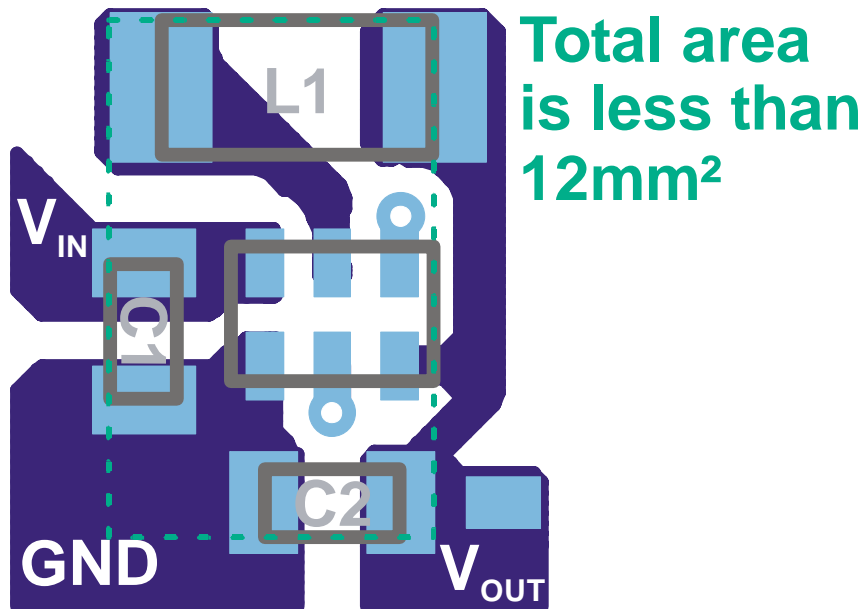

Figure 3. TPS62730 typical application compact layout

5 CC254x + TPS62730 Reference Design

The reference design uses the existing CC2540 Reference Design [2] and adds the TPS62730 [1] as defined in the datasheet. The TPS62730 is controlled by the CC254x, through Pin P1.2. (The TPS62730 can be controlled by any GPIO. The BLE Stack v1.2 will have a function to choose the GPIO to control the TPS62730)

5.1 ON/BYP Mode Selection

The TPS62730 converter is activated when ON/BYP is set high. This pin is controlled by the CC254x pin P1.2 for proper mode selection. Pulling the ON/BYP pin low activates the Ultra Low Power Bypass Mode with typical 30nA current consumption. In this mode, the internal bypass switch is turned on and the output of the TPS62730 converter is connected to the battery. All other circuits like the entire internal-control circuitry, the P and N-channel MOSFET's of the DC/DC output stage are turned off as well the internal resistor feedback divider is disconnected

5.2 Start Up

Once the device is supplied with a battery voltage, the bypass switch is activated. If the ON/BYP pin is set to high, the device operates in bypass mode until the TPS62730 converter has settled and can kick in. During start up, high peak currents can flow over the bypass switch to charge up the output capacitor and the additional decoupling capacitors in the system.

5.3 Automatic Transition from DC/DC to Bypass Operation

With pin ON/BYP set to high, the TPS62730 features an automatic transition between DC/DC and bypass mode to reduce the output ripple voltage to zero. Once the input voltage comes close to the output voltage of the TPS62730 converter, the DC/DC converter operates close to 100% duty cycle operation. At this operating condition, the switch frequency would start to drop and would lead to increased output ripple voltage. The internal bypass switch is turned on once the battery voltage trips the Automatic Bypass Transition Threshold VIT BYP for falling VIN. The TPS62730 regulator is turned off and therefore it generates no output ripple voltage. Once the input voltage increases and trips the bypass deactivation threshold VIT BYP for rising VIN, the DC/DC regulator turns on and the bypass switch is turned off.

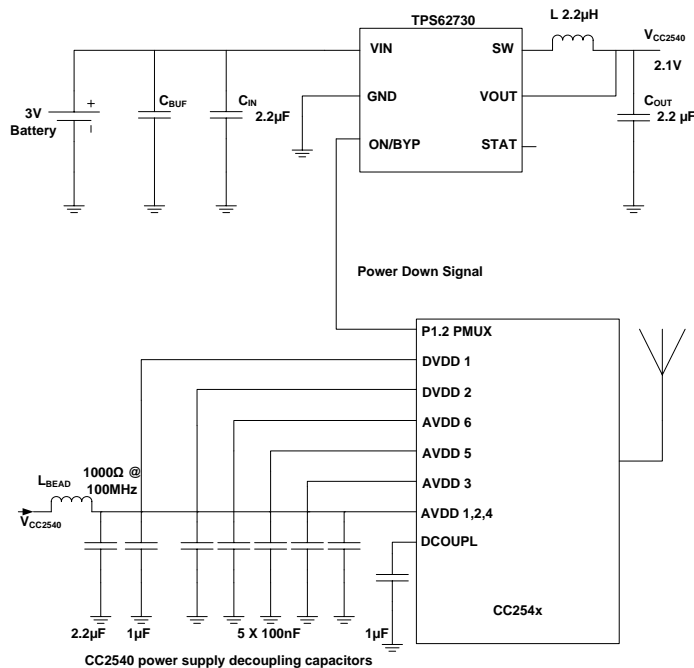

Application Note AN097

Figure 4. CC2540 + TPS62730 Application

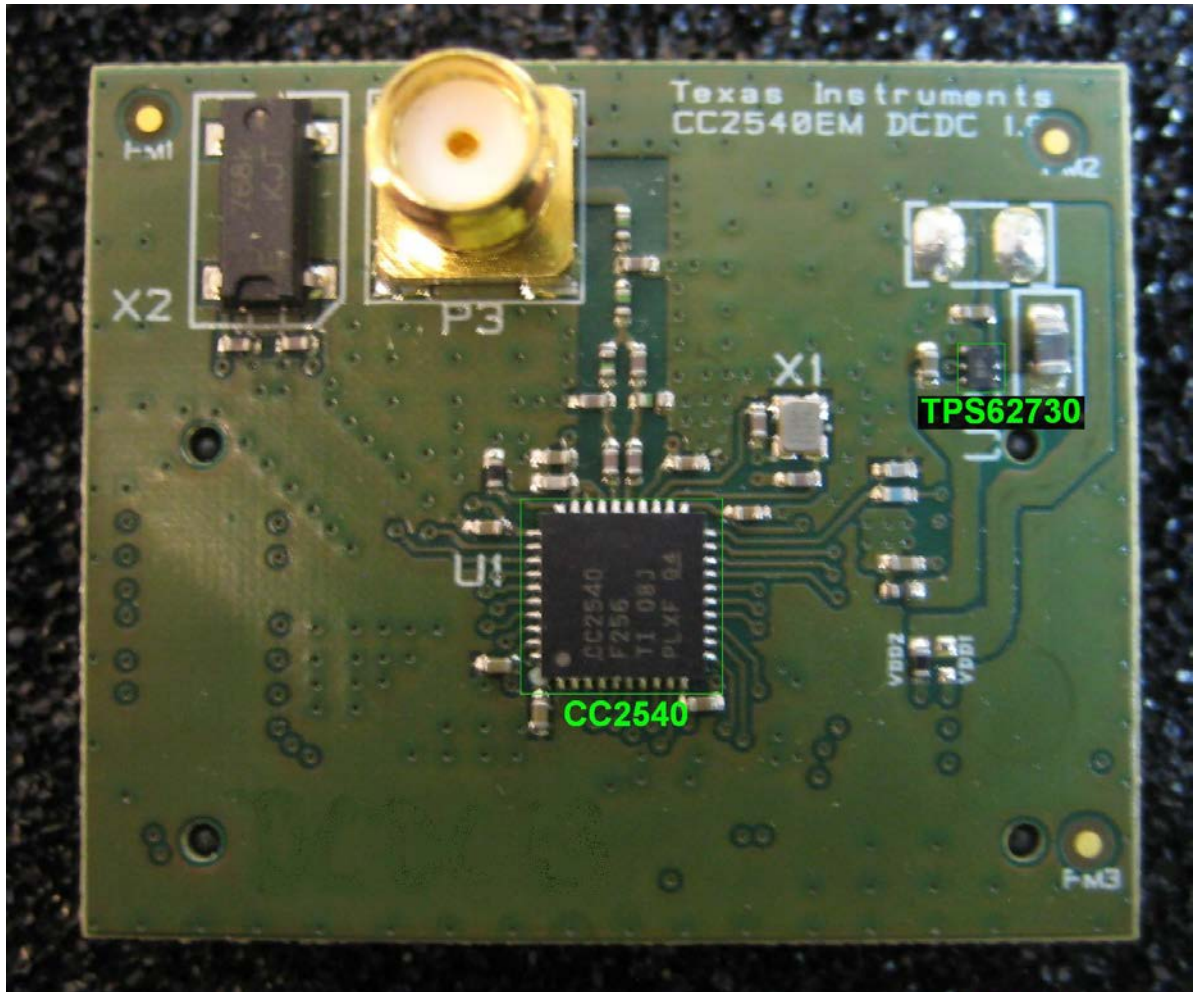

Figure 5. CC2540EM DCDC 1.0 Combo board

6 Current

6.1 Receive Current

The receive current was measured at different supply voltages to the combo board over temperature variation. The input signal is maintained at -70dBm.

State: wait for sync, idle and minimum clock (CLKCONMOD = 0x80 (XOSC no division to 250 kHz and 32 kHz RCOSC))

		Unit	Supply					
			2.1	2.4	2.7	3	3.3	3.6
CC2540	Standard Gain	mA	21.3	20.8	19.0	17.4	16.0	14.8
	High Gain	mA	23.7	23.3	21.2	19.5	17.9	16.4
CC2541	Standard Gain	mA	17.9	17.0	15.6	14.3	13.1	12.1
	High Gain	mA	20.4	19.3	17.6	16.2	14.9	13.7

Table 1. RX Current over supply variation

CC2540/CC2541 Current over Supply

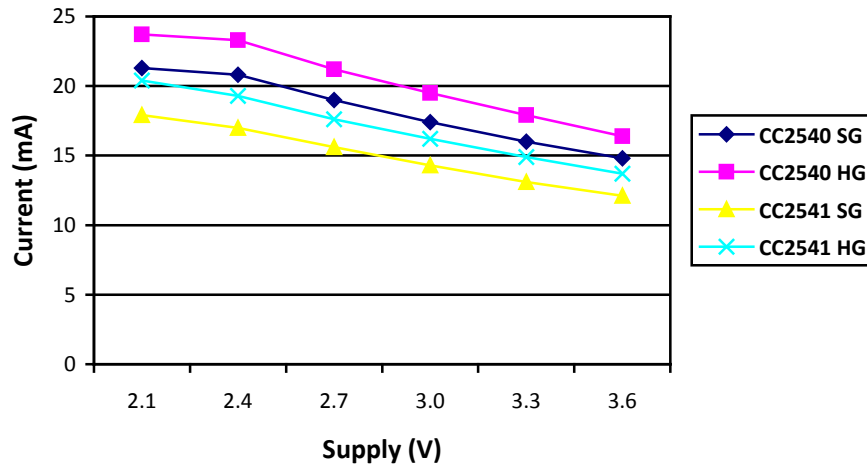

Figure 6. RX Current over supply variation

6.2 Receive Current Comparison (Standard Gain)

The receive current was measured at different supply voltages. The TPS62730 is kept ON for one run and OFF for the next. The input signal is maintained at -70dBm.

State: wait for sync, idle and minimum clock (CLKCONMOD = 0x80 (XOSC divided to 250 kHz and 32 kHz RCOSC))

		Unit	Supply					
			2.1	2.4	2.7	3	3.3	3.6
CC2540	DC/DC ON	mA	21.3	20.8	19.0	17.4	16.0	14.8
	DC/DC OFF	mA	21.3	21.5	21.6	21.8	22.0	22.4
	Savings	%	0.0	3.2	11.9	19.9	27.2	34.2
CC2541	DC/DC ON	mA	17.9	17.0	15.6	14.3	13.1	12.1
	DC/DC OFF	mA	17.9	18.0	18.0	18.1	18.1	18.2
	Savings	%	0.0	5.3	13.6	20.9	27.7	33.5

Table 2. RX current comparison

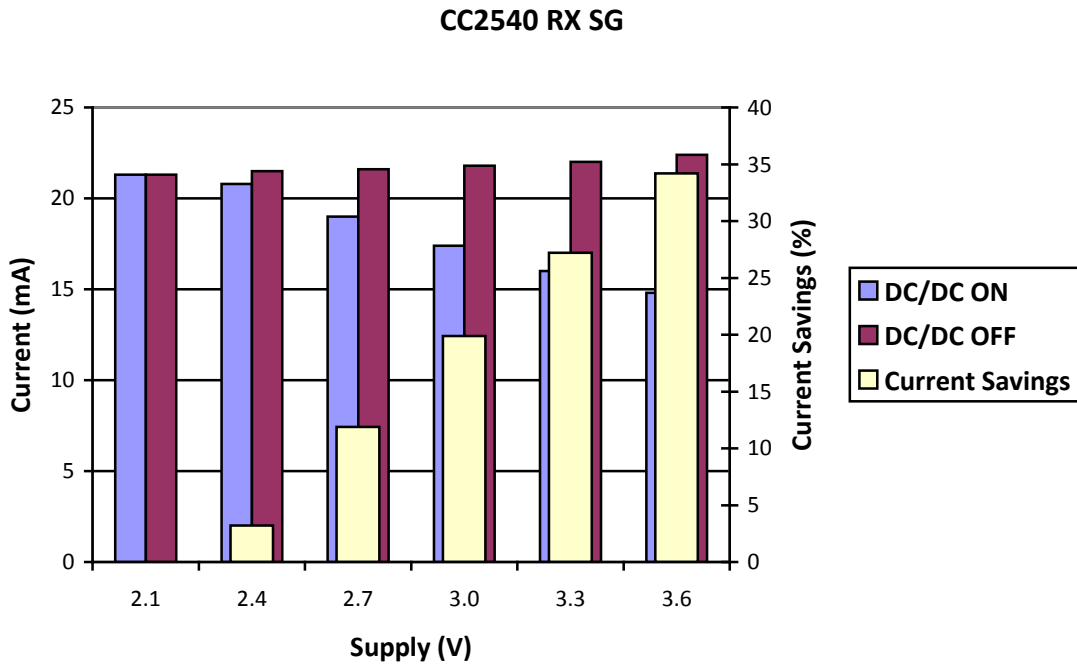

Figure 7a: CC2540 current saving in RX at room temperature

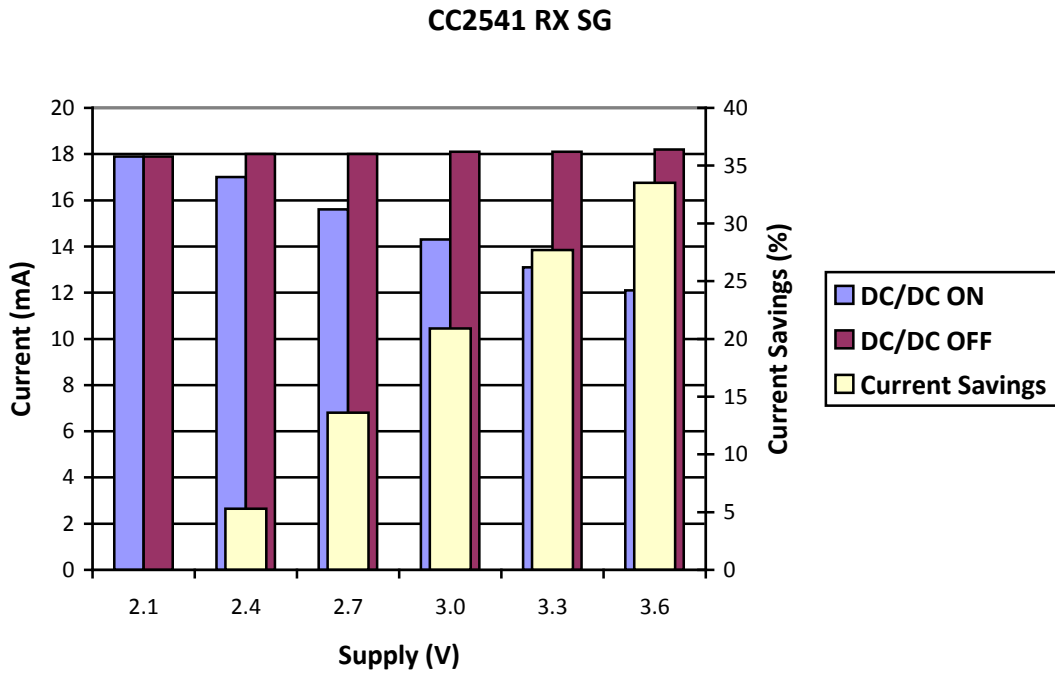

Figure 7b: CC2541 current saving in RX at room temperature

6.3 Transmit Current

The transmit current was measured at different supply voltages for different power settings. State: idle and minimum clock (CLKCONMOD = 0xBF (XOSC divided to 250 kHz and 32 kHz RCOSC))

	Power Setting	Unit	Supply					
			2.1	2.4	2.7	3.0	3.3	3.6
CC2540	4 dBm	mA	31.0	29.1	26.6	24.6	22.6	20.9
	0 dBm	mA	26.4	24.9	22.7	21.0	19.3	17.9
CC2541	0 dBm	mA	18.4	17.6	16.1	14.8	13.6	12.6

Table 3. TX current over supply variation, different power settings with DC/DC ON

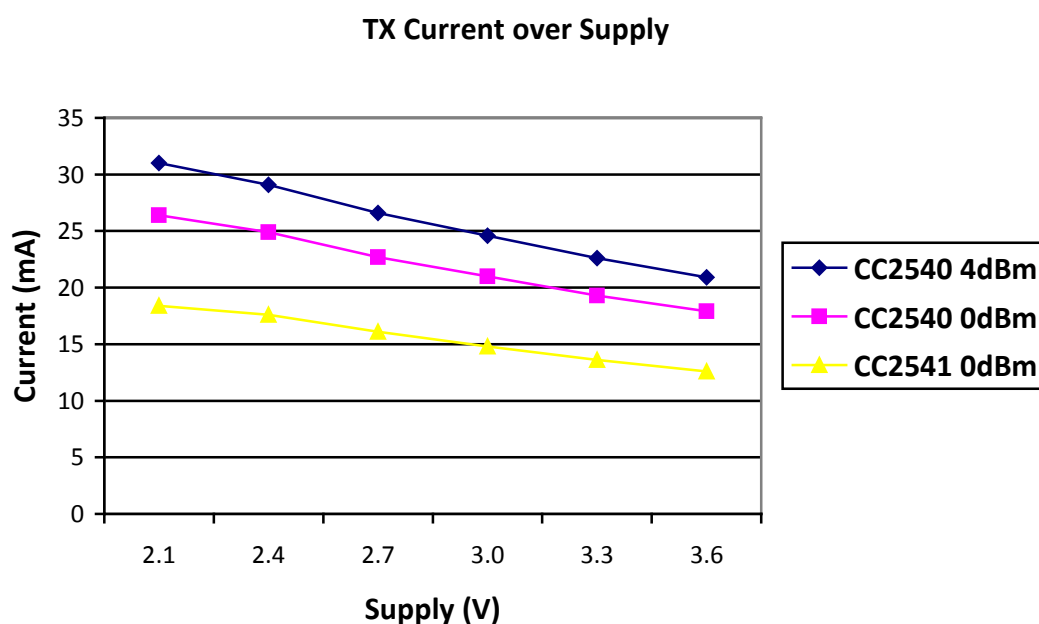

Figure 8. TX current over supply variation with DC/DC ON

6.4 Transmit Current Comparison (0 dBm)

The transmit current was measured at different supply voltages to the combo board. The TPS62730 is kept ON for one run and OFF for the next. State: idle and minimum clock (CLKCONMOD = 0xBF (XOSC divided to 250 kHz and 32 kHz RCOSC))

		Unit	Supply					
			2.10	2.40	2.70	3.00	3.30	3.60
CC2540	DC/DC ON	mA	26.4	24.9	22.7	21.0	19.3	17.9
	DC/DC OFF	mA	26.4	26.6	26.8	27.0	27.1	27.4
	Savings	%	0	6.5	15.2	22.3	28.8	34.8
CC2541	DC/DC ON	mA	18.4	17.6	16.1	14.8	13.6	12.6
	DC/DC OFF	mA	18.4	18.5	18.6	18.6	18.7	18.8
	Savings	%	0	5.1	13.4	20.5	27.2	33.2

Table 4. Current savings in TX at room temperature

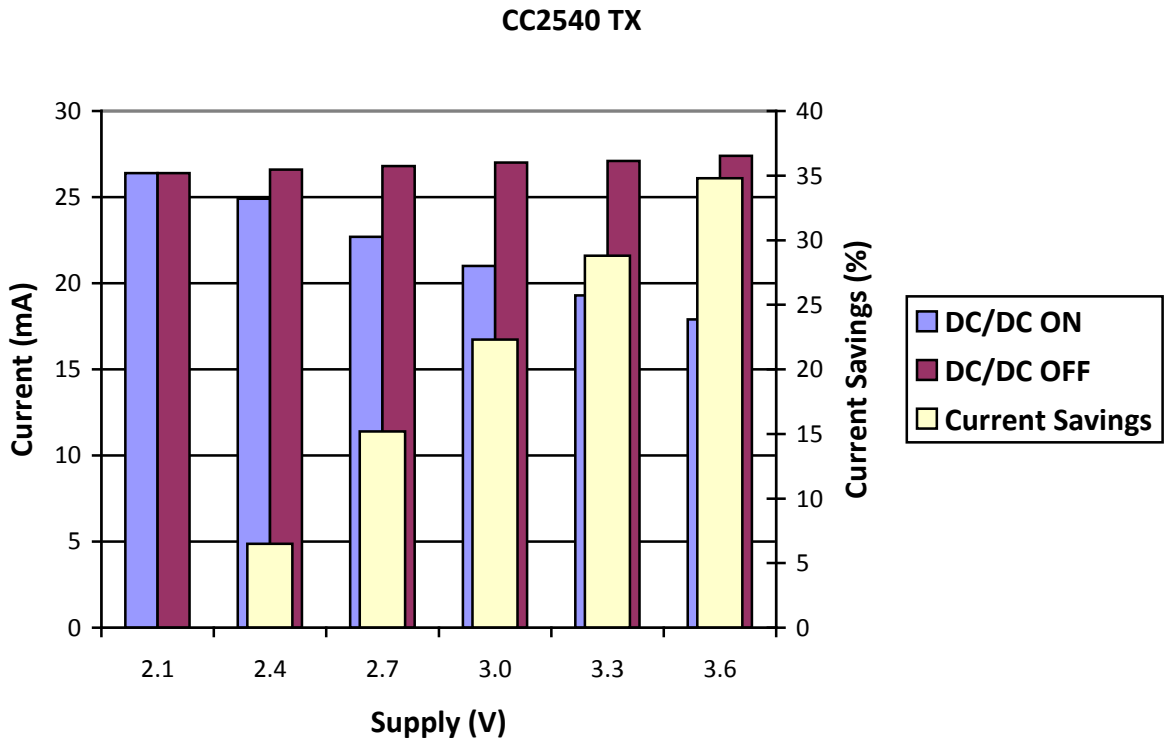

Figure 9a. CC2540 current savings in TX at room temperature

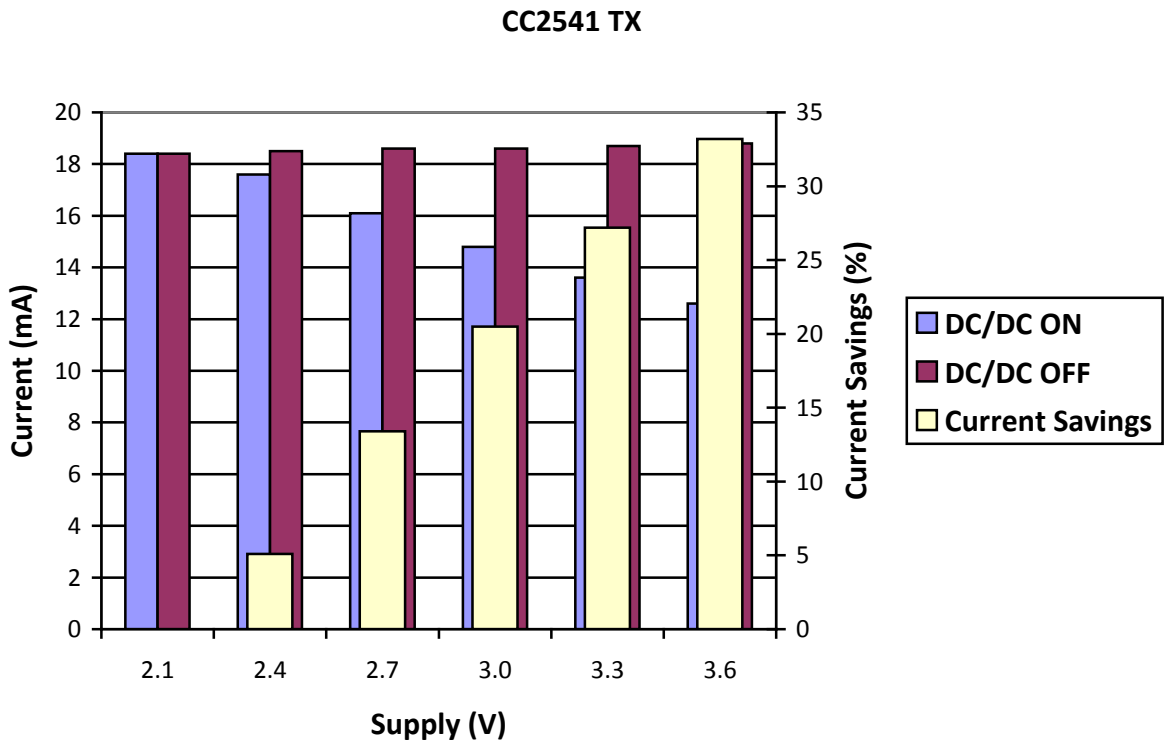

Figure 9b. CC2541 current savings in TX at room temperature

6.5 Connection Event

The plots below show the current of a typical BLE connection event. The measurement technique is based on to that shown in Measuring Bluetooth® Low Energy Power Consumption [4]. In this case, since a SOC_BB battery board is used, there is no need to solder the 10Ω resistor. Simply place the 10Ω resistor in series with supply connections to the battery board. Capture the voltage across the 10Ω resistor on an oscilloscope. The figures 10 and 11 are voltage capture of the current drawn by the CC2540+TPS62730 combo board with and without the DC/DC functioning. The supply voltage is maintained at 3V for both tests. In the connection event the CC2540 is set to 4dBm output power during TX, while in RX the device is in HG mode.

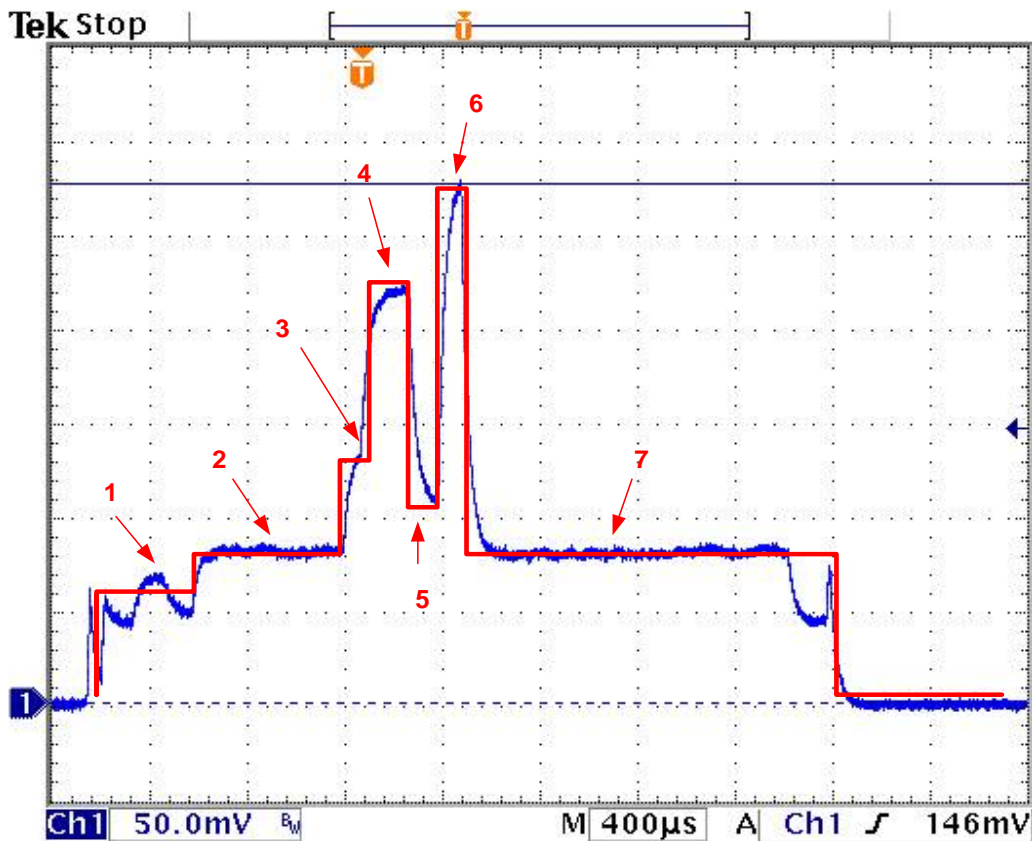

Figure 10. Single connection event when the DC/DC is OFF

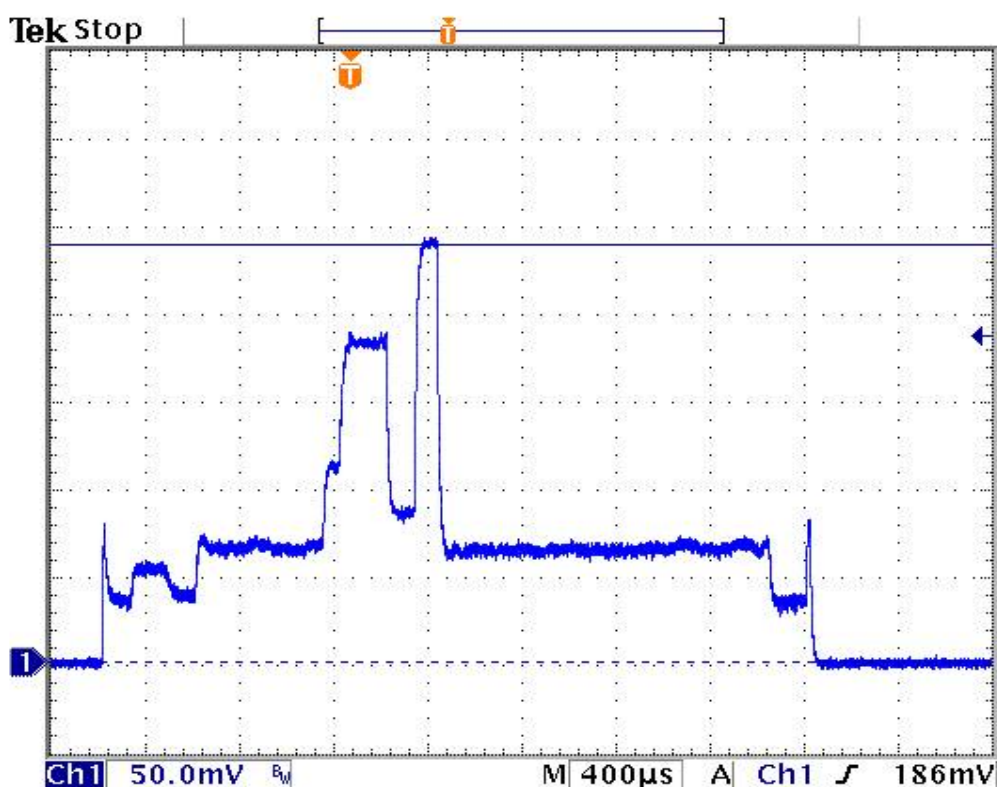

Figure 11. Single connection event when the DC/DC is ON

The Table 5a and 5b below gives us a fairly accurate comparison of the average current used in each state by the combo board during a single connection event when the TPS62730 is ON and OFF

State	Current (mA)	
	DC/DC OFF	DC/DC ON
State 1 (wake-up)	6.1	5.2
State 2 (pre-processing)	8.1	6.4
State 3 (pre-Rx)	12.3	11.0
State 4 (Rx)	22.3	18.1
State 5 (Rx-to-Tx)	11.1	8.6
State 6 (Tx)	29.3	23.8
State 7 (post-processing)	8.1	6.4

Table 5a. CC2540 current savings in a single connection event

State	Current (mA)	
	DC/DC OFF	DC/DC ON
State 1 (wake-up)	7.1	5.4
State 2 (pre-processing)	8.4	6.9
State 3 (pre-Rx)	11.6	10.7
State 4 (Rx)	18.9	15.4
State 5 (Rx-to-Tx)	9.2	5.8
State 6 (Tx)	18.3	15.1
State 7 (post-processing)	8.1	6.7

Table 5b. CC2541 current savings in a single connection event

7 RF Performance

7.1 Receive Sensitivity and Saturation of the CC2540

For all packet error rate measurements the BLE packet format is used.

1 byte preamble, 4 byte sync word, 1 byte PDU header, 1 byte PDU length, 37 byte payload and 3 byte CRC

When using raw packet mode (payload length > 37) the PDU header, PDU length and CRC are counted in the packet length. In measurement stating 250 byte payload, this gives the maximum packet length of 255 byte.

The sensitivity and saturation are measured with standard gain (SG) RX settings at 3V supply at room temperature [Table 6].

Frequency (MHz)	Unit	Sensitivity			Saturation		
		Max	noDCDC	DCDC	Min	noDCDC	DCDC
2400	dBm	-82	-86	-86	0	6.7	6.7
2410	dBm	-82	-86	-86	0	6.7	6.7
2420	dBm	-82	-86	-85.5	0	6.7	6.7
2430	dBm	-82	-85.5	-85.5	0	6.6	6.6
2440	dBm	-82	-85.5	-85.5	0	6.6	6.6
2450	dBm	-82	-86.5	-86.5	0	6.6	6.6
2460	dBm	-82	-86.5	-86.5	0	6.6	6.6
2470	dBm	-82	-86.5	-86.5	0	6.6	6.6
2480	dBm	-82	-86.5	-86.5	0	6.6	6.6

Table 6. Sensitivity and Saturation with and without DCDC at 3V supply

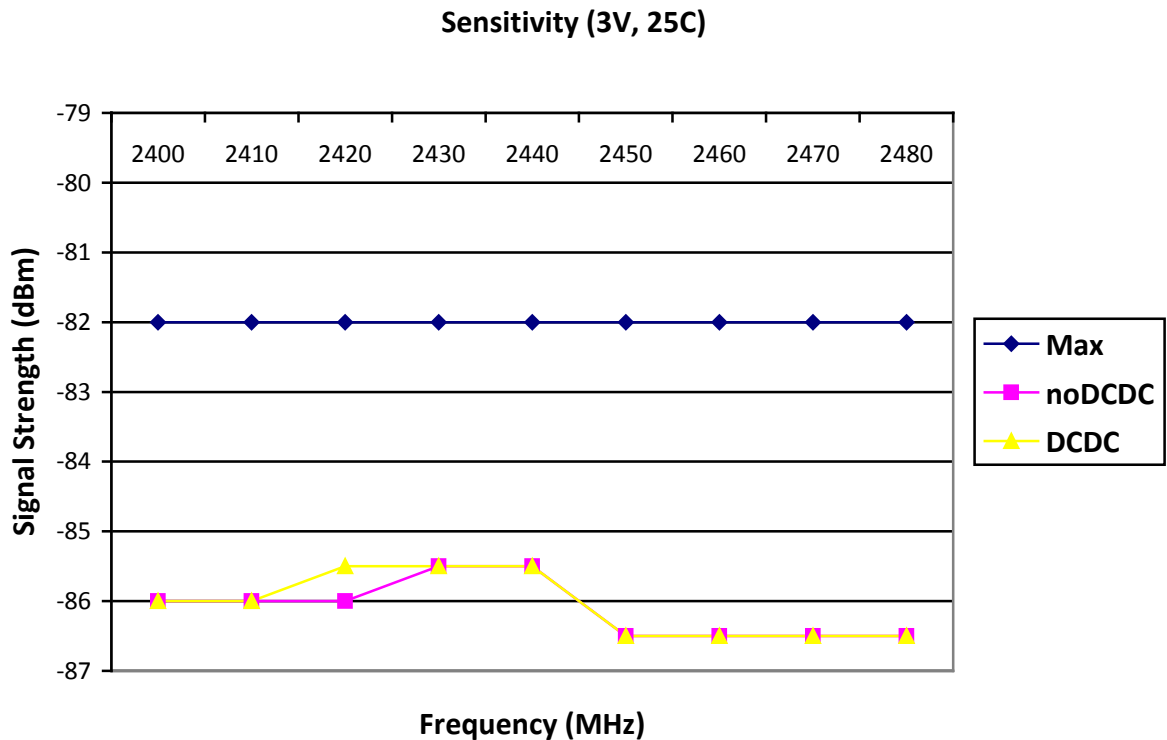

Figure 12. Sensitivity comparison with and without DCDC

Saturation (3V, 25C)

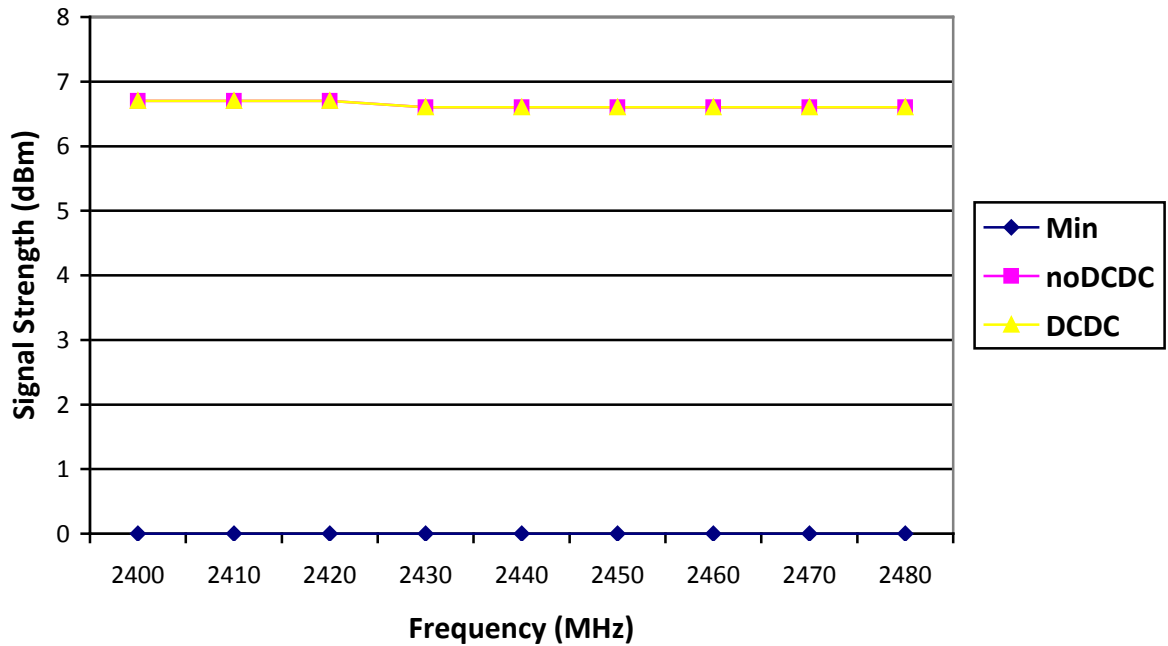

Figure 13. Saturation comparison with and without DCDC

7.2 Transmit Power of the CC2540

Table 7 compares output power when the output power setting is 0xF5 (4dBm) with and without DCDC.

Frequency (MHz)	Unit	Min	Max	noDCDC	DCDC
2400	dBm	-2	9	4.3	4.3
2410	dBm	-2	9	4.1	4.1
2420	dBm	-2	9	4.1	4.1
2430	dBm	-2	9	4.0	4.1
2440	dBm	-2	9	3.9	4.0
2450	dBm	-2	9	3.9	4.0
2460	dBm	-2	9	3.9	3.9
2470	dBm	-2	9	3.8	3.8
2480	dBm	-2	9	3.6	3.7

Table 7. Output power comparison with and without DCDC at 3V supply

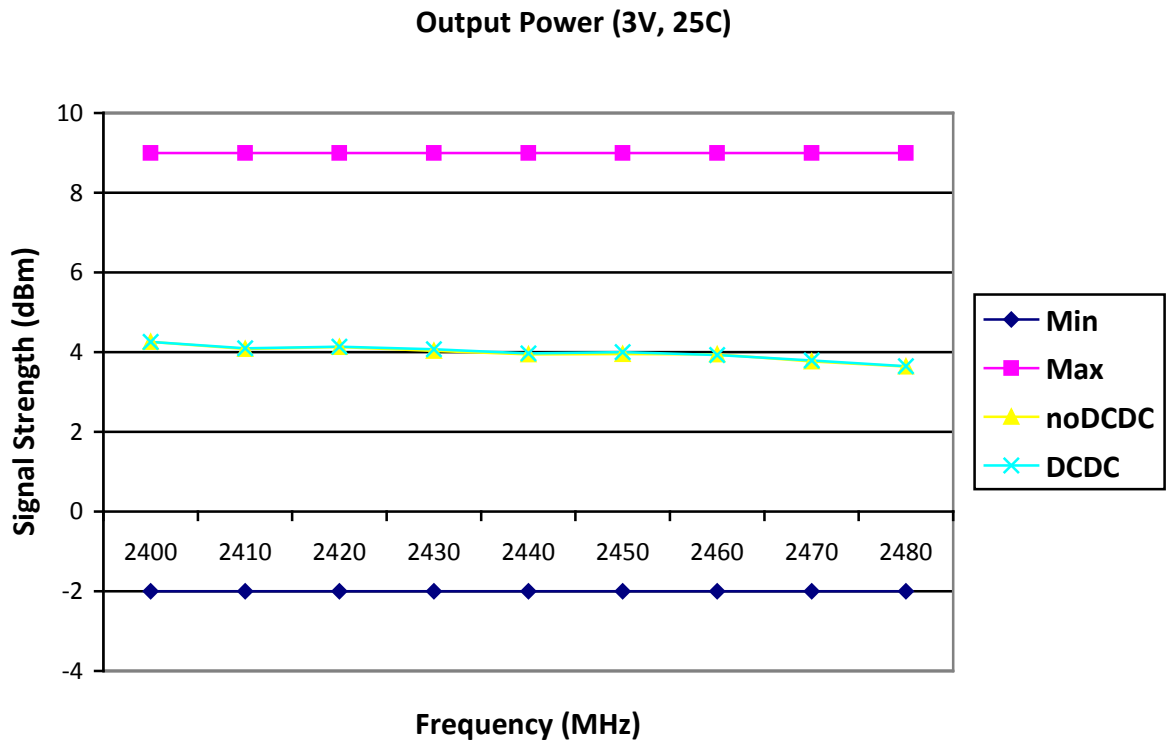

Figure 14. Output power with and without DCDC at 3V supply

7.3 TX Spectrogram of the CC2540

Tested with 1 Mbps GFSK 250 kHz deviation at 3V supply voltage

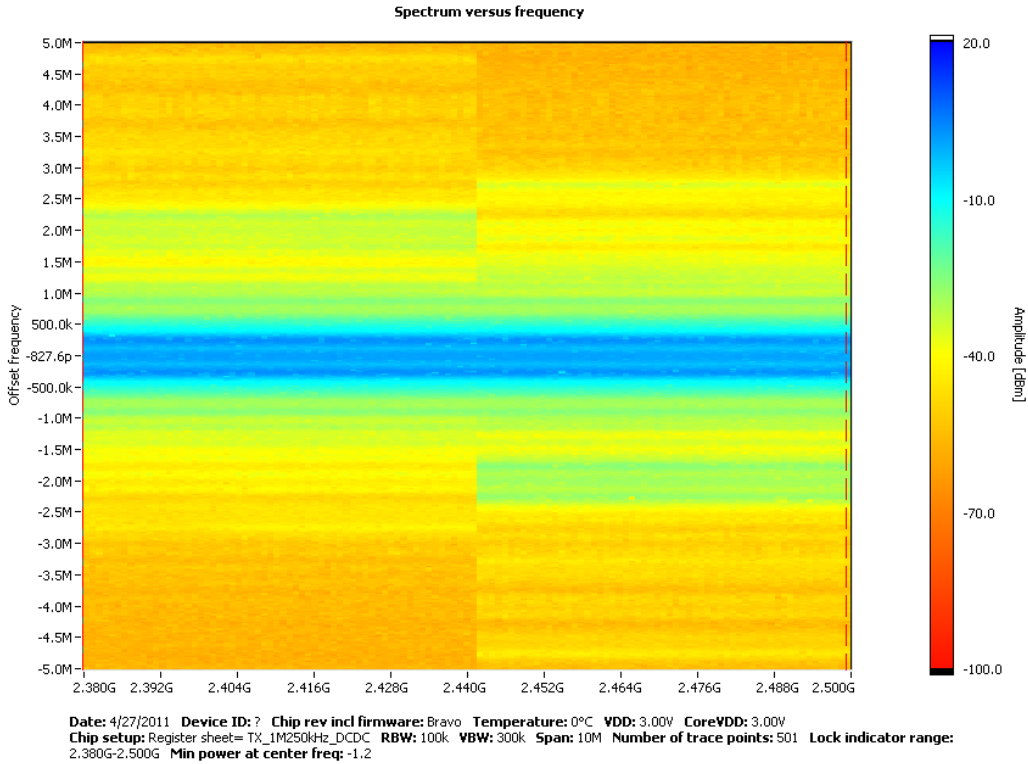

Figure 15. TX spectrogram without DCDC at 3V supply

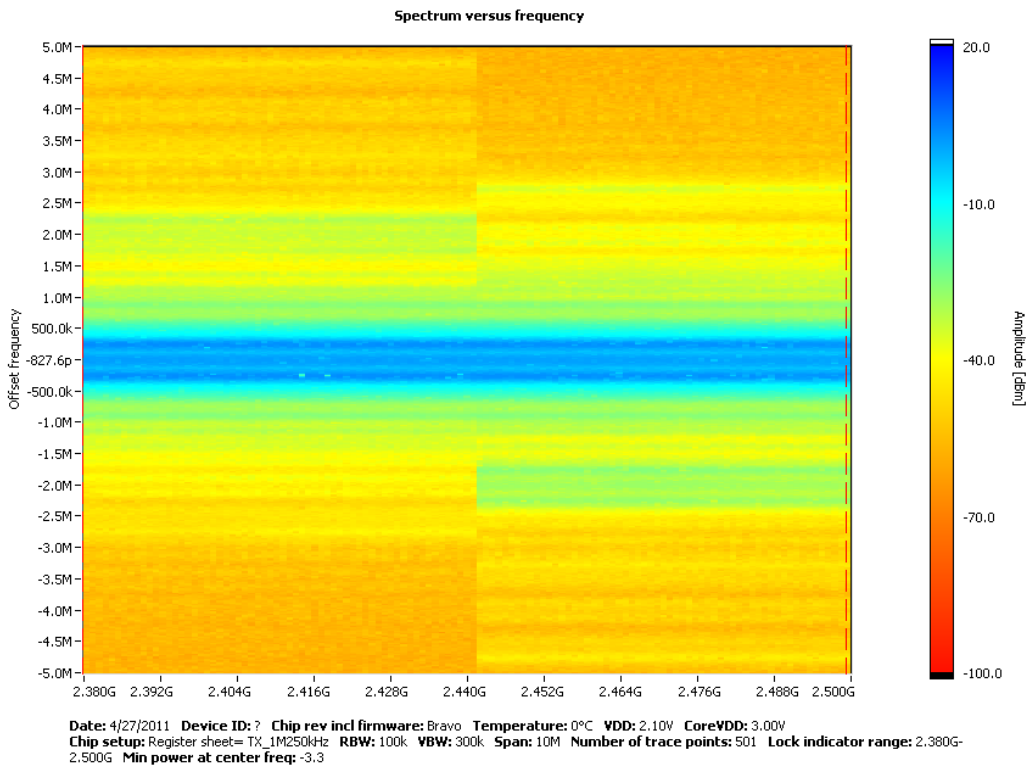

Figure 16. TX spectrogram with DCDC at 3V supply

7.4 Receive Sensitivity and Saturation of the CC2541

For all packet error rate measurements the BLE packet format is used.

1 byte preamble, 4 byte sync word, 1 byte PDU header, 1 byte PDU length, 37 byte payload and 3 byte CRC

When using raw packet mode (payload length > 37) the PDU header, PDU length and CRC are counted in the packet length. In measurement stating 250 byte payload, this gives the maximum packet length of 255 byte.

The sensitivity and saturation are measured with standard gain (SG) RX settings at 3V supply at room temperature [Table 6].

Frequency (MHz)	Unit	Sensitivity			Saturation		
		Max	noDCDC	DCDC	Min	noDCDC	DCDC
2400	dBm	-85	-88.6	-88.6	0	6.8	6.8
2410	dBm	-85	-88.7	-88.6	0	6.8	6.8
2420	dBm	-85	-88.6	-88.6	0	6.8	6.8
2430	dBm	-85	-88.4	-88.4	0	6.7	6.7
2440	dBm	-85	-88.3	-88.3	0	6.7	6.7
2450	dBm	-85	-88.6	-88.6	0	6.7	6.7
2460	dBm	-85	-88.6	-88.6	0	6.7	6.7
2470	dBm	-85	-88.5	-88.5	0	6.8	6.8
2480	dBm	-85	-88.4	-88.4	0	6.8	6.8

Table 8. Sensitivity and Saturation with and without DCDC at 3V supply

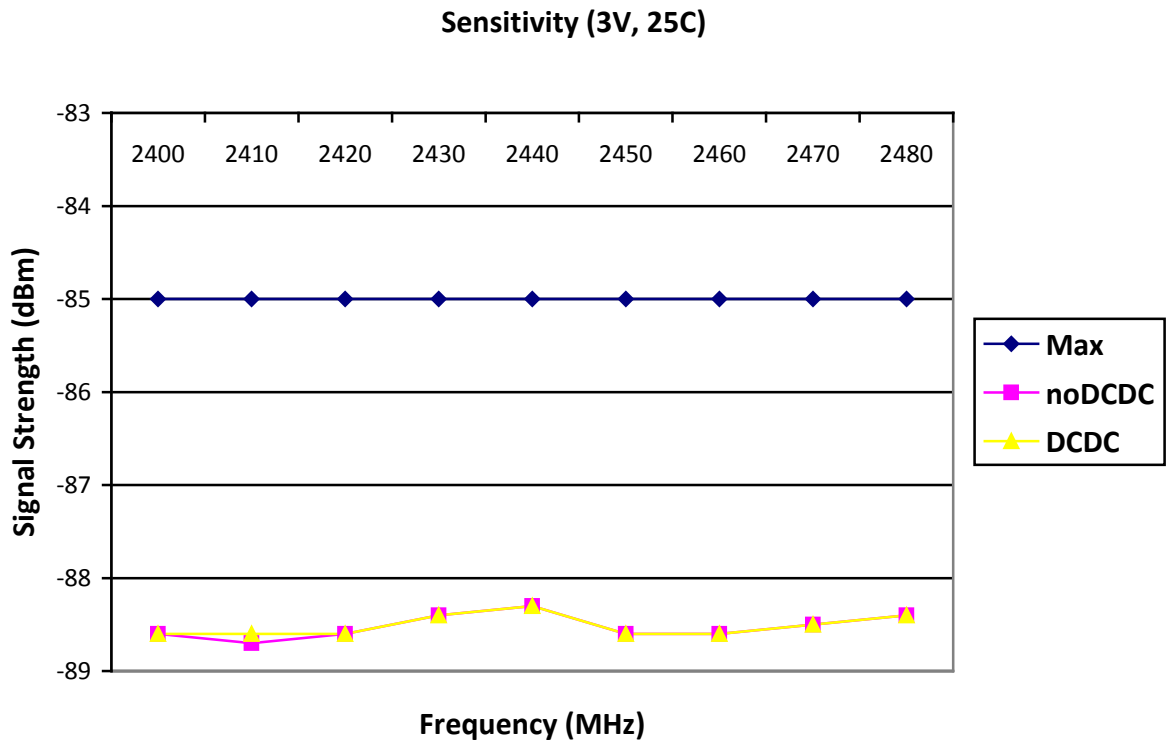

Figure 17. Sensitivity comparison with and without DCDC

Saturation (3V, 25C)

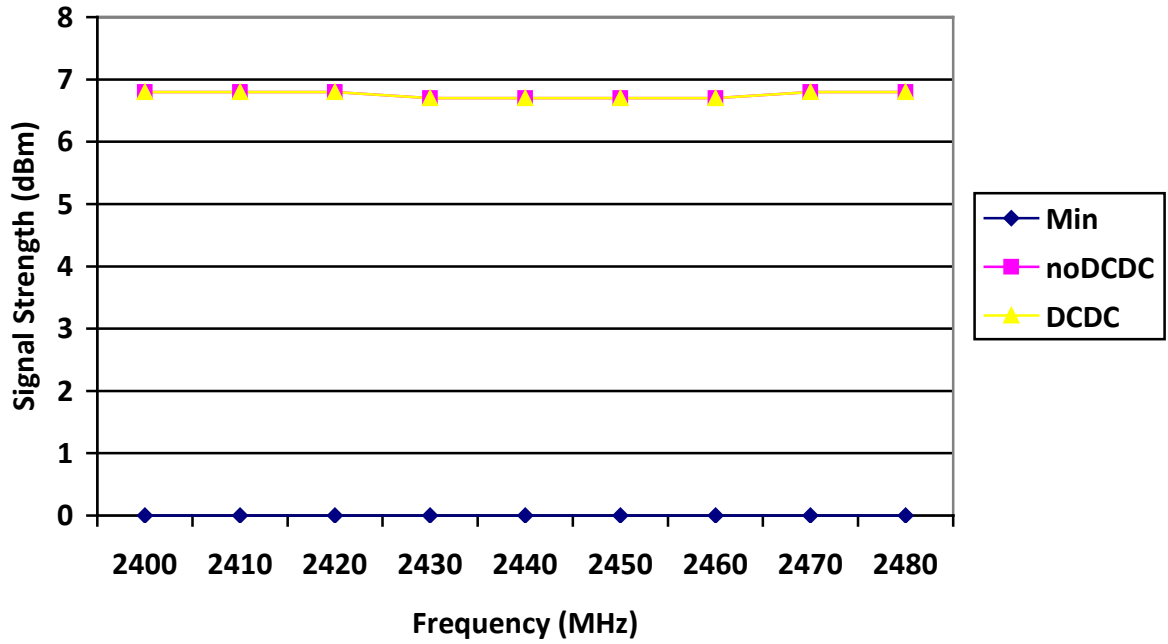

Figure 18. Saturation comparison with and without DCDC

7.5 Transmit Power of the CC2541

Table 7 compares output power when the output power setting is 0xE1 (0dBm) with and without DCDC.

Frequency (MHz)	Unit	Min	Max	noDCDC	DCDC
2400	dBm	-2	2	1.3	1.1
2410	dBm	-2	2	0.9	0.8
2420	dBm	-2	2	0.8	0.6
2430	dBm	-2	2	0.7	0.6
2440	dBm	-2	2	0.5	0.4
2450	dBm	-2	2	0.7	0.6
2460	dBm	-2	2	0.7	0.6
2470	dBm	-2	2	0.2	0.1
2480	dBm	-2	2	-0.2	-0.4

Table 9. Output power comparison with and without DCDC at 3V supply

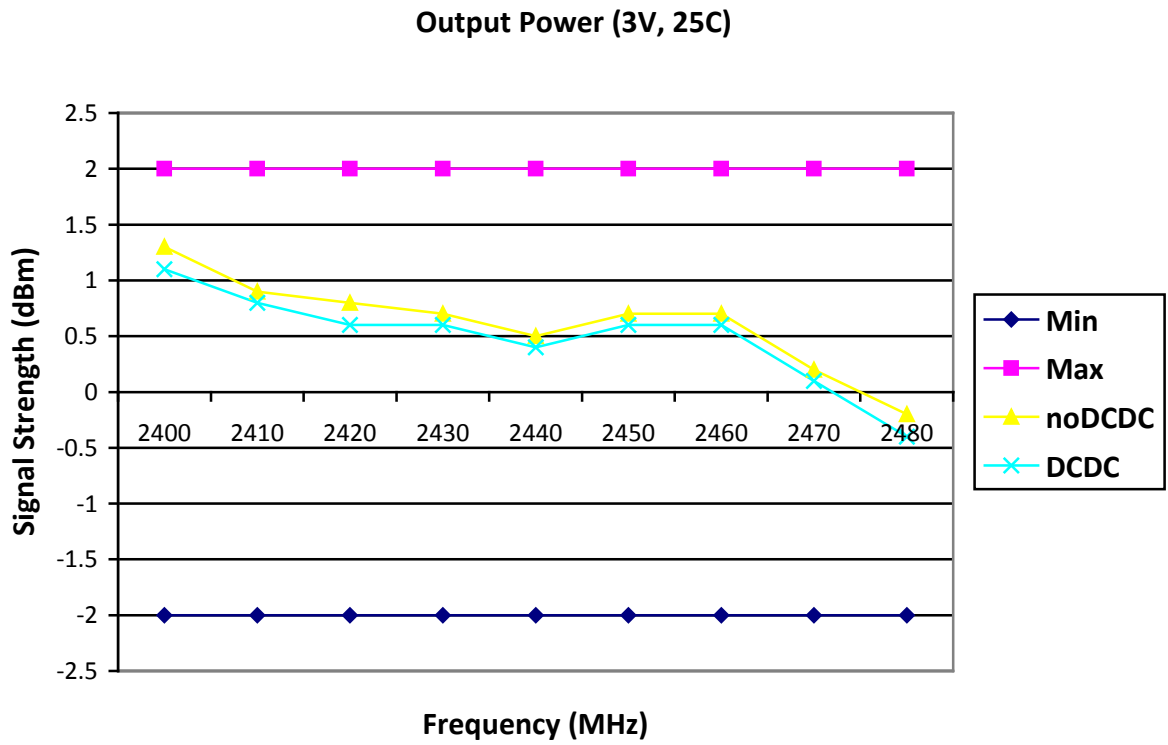

Figure 19. Output power with and without DCDC at 3V supply

7.6 TX Spectrogram of the CC2541

Tested with 1 Mbps GFSK 250 kHz deviation at 3V supply voltage

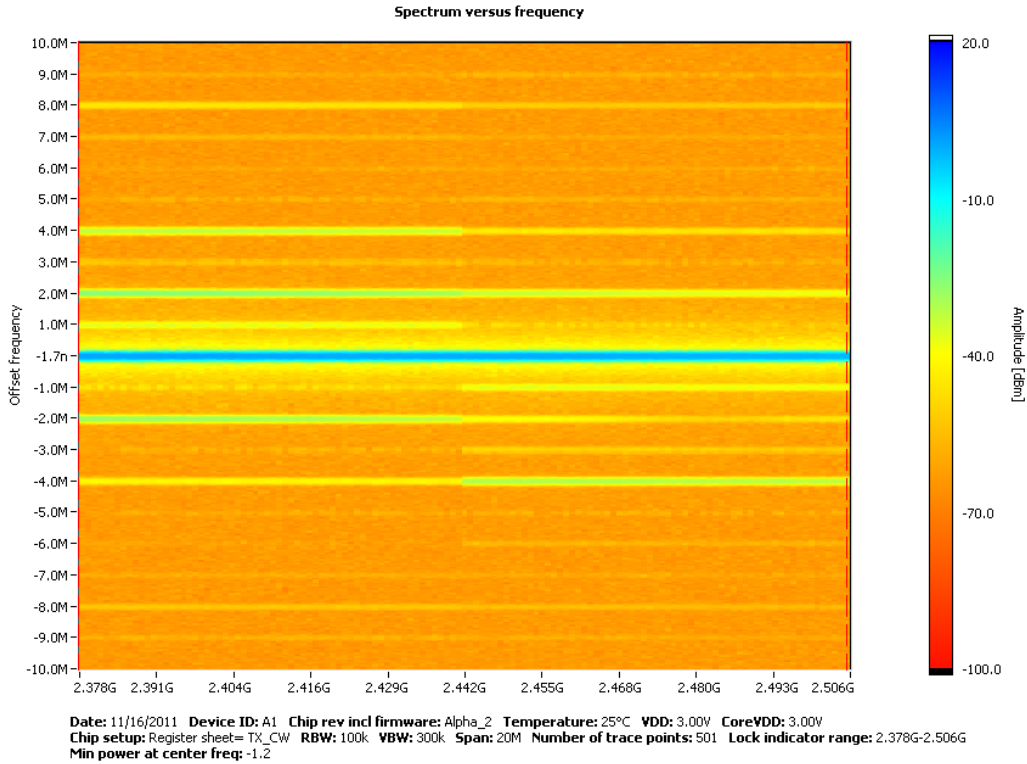

Figure 20. TX spectrogram without DCDC at 3V supply

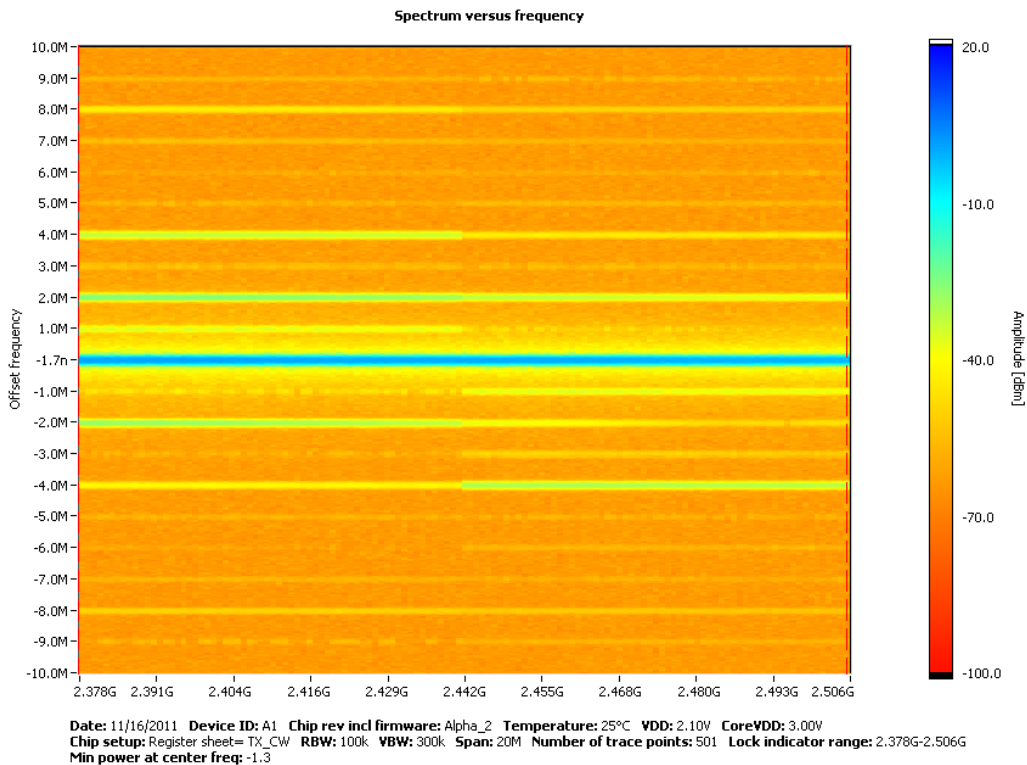

Figure 21. TX spectrogram with DCDC at 3V supply

7.7 Conclusion

From the above measurement the TPS62730 has little effect on the RF performance of the CC254x. Thus making the TPS62730 a good match to work with the CC254x family; reducing the peak current drawn by the CC254x in active mode which would there by improve the overall battery life of the chip. All this without compromising on RF performance.

8 References

- [1] [TPS62730 Datasheet](#)
- [2] [CC2540EM Reference Design](#)
- [3] [CC2540TPS62730EM Reference Design](#)
- [4] [Measuring Bluetooth® Low Energy Power Consumption](#)
- [5] [SOC_BB Reference Design](#)
- [6] [Coin Cells And Peak Current Draw](#)
- [7] [CC2541TPS62730EM Reference Design](#)

9 General Information

9.1 Document History

Revision	Date	Description/Changes
SWRA365	7/1/2011	Initial release.
SWRA365	2/8/2012	Additional CC2541 results

IMPORTANT NOTICE

Texas Instruments Incorporated and its subsidiaries (TI) reserve the right to make corrections, modifications, enhancements, improvements, and other changes to its products and services at any time and to discontinue any product or service without notice. Customers should obtain the latest relevant information before placing orders and should verify that such information is current and complete. All products are sold subject to TI's terms and conditions of sale supplied at the time of order acknowledgment.

TI warrants performance of its hardware products to the specifications applicable at the time of sale in accordance with TI's standard warranty. Testing and other quality control techniques are used to the extent TI deems necessary to support this warranty. Except where mandated by government requirements, testing of all parameters of each product is not necessarily performed.

TI assumes no liability for applications assistance or customer product design. Customers are responsible for their products and applications using TI components. To minimize the risks associated with customer products and applications, customers should provide adequate design and operating safeguards.

TI does not warrant or represent that any license, either express or implied, is granted under any TI patent right, copyright, mask work right, or other TI intellectual property right relating to any combination, machine, or process in which TI products or services are used. Information published by TI regarding third-party products or services does not constitute a license from TI to use such products or services or a warranty or endorsement thereof. Use of such information may require a license from a third party under the patents or other intellectual property of the third party, or a license from TI under the patents or other intellectual property of TI.

Reproduction of TI information in TI data books or data sheets is permissible only if reproduction is without alteration and is accompanied by all associated warranties, conditions, limitations, and notices. Reproduction of this information with alteration is an unfair and deceptive business practice. TI is not responsible or liable for such altered documentation. Information of third parties may be subject to additional restrictions.

Resale of TI products or services with statements different from or beyond the parameters stated by TI for that product or service voids all express and any implied warranties for the associated TI product or service and is an unfair and deceptive business practice. TI is not responsible or liable for any such statements.

TI products are not authorized for use in safety-critical applications (such as life support) where a failure of the TI product would reasonably be expected to cause severe personal injury or death, unless officers of the parties have executed an agreement specifically governing such use. Buyers represent that they have all necessary expertise in the safety and regulatory ramifications of their applications, and acknowledge and agree that they are solely responsible for all legal, regulatory and safety-related requirements concerning their products and any use of TI products in such safety-critical applications, notwithstanding any applications-related information or support that may be provided by TI. Further, Buyers must fully indemnify TI and its representatives against any damages arising out of the use of TI products in such safety-critical applications.

TI products are neither designed nor intended for use in military/aerospace applications or environments unless the TI products are specifically designated by TI as military-grade or "enhanced plastic." Only products designated by TI as military-grade meet military specifications. Buyers acknowledge and agree that any such use of TI products which TI has not designated as military-grade is solely at the Buyer's risk, and that they are solely responsible for compliance with all legal and regulatory requirements in connection with such use.

TI products are neither designed nor intended for use in automotive applications or environments unless the specific TI products are designated by TI as compliant with ISO/TS 16949 requirements. Buyers acknowledge and agree that, if they use any non-designated products in automotive applications, TI will not be responsible for any failure to meet such requirements.

Following are URLs where you can obtain information on other Texas Instruments products and application solutions:

Products

Audio	www.ti.com/audio
Amplifiers	amplifier.ti.com
Data Converters	dataconverter.ti.com
DLP® Products	www.dlp.com
DSP	dsp.ti.com
Clocks and Timers	www.ti.com/clocks
Interface	interface.ti.com
Logic	logic.ti.com
Power Mgmt	power.ti.com
Microcontrollers	microcontroller.ti.com
RFID	www.ti-rfid.com
OMAP Mobile Processors	www.ti.com/omap
Wireless Connectivity	www.ti.com/wirelessconnectivity

Applications

Automotive and Transportation	www.ti.com/automotive
Communications and Telecom	www.ti.com/communications
Computers and Peripherals	www.ti.com/computers
Consumer Electronics	www.ti.com/consumer-apps
Energy and Lighting	www.ti.com/energy
Industrial	www.ti.com/industrial
Medical	www.ti.com/medical
Security	www.ti.com/security
Space, Avionics and Defense	www.ti.com/space-avionics-defense
Video and Imaging	www.ti.com/video

TI E2E Community Home Page

e2e.ti.com

Mailing Address: Texas Instruments, Post Office Box 655303, Dallas, Texas 75265
Copyright © 2012, Texas Instruments Incorporated