

# SimpleLink™ Wi-Fi® CC313x, CC323x BLE Coexistence



## ABSTRACT

The 2.4-GHz band is used by many wireless communication standards and proprietary wireless implementations. When two different entities use the same wireless band in close proximity, there must be a coexistence mechanism to avoid significant degradation in performance.

This document describes the SimpleLink™ Wi-Fi® CC3x3x Bluetooth® low energy (BLE) coexistence mechanism, and explains how to use it.

## Table of Contents

<b>1 Introduction</b> .....	3
1.1 System Block Diagram.....	3
1.2 Terminology and Abbreviations.....	4
<b>2 Requirements</b> .....	4
2.1 System Requirements.....	4
2.2 BLE Requirements.....	4
2.3 BLE Connection Parameters.....	5
2.4 User Application Requirements.....	5
2.5 Wi-Fi® Requirements.....	5
2.6 System Configurations.....	5
<b>3 Enabling BLE Coexistence Capability</b> .....	11
3.1 Using the Image Creator.....	11
3.2 Using an API.....	11
3.3 Pad Selection.....	12
<b>4 Test Results</b> .....	13
4.1 Test Setup Description.....	13
4.2 Test Results – Wi-Fi® Throughput Impact on BLE Throughput.....	15
4.3 Test Results – Wi-Fi® Throughput Impact on BLE Connection Quality.....	17
4.4 Test Results – BLE Throughput Impact on Wi-Fi® Throughput.....	19
<b>5 Revision History</b> .....	22

## List of Figures

Figure 1-1. System Block Diagram.....	3
Figure 2-1. Coexistence Signaling Timing Diagram.....	4
Figure 2-2. BLE Coexistence Block Diagram.....	6
Figure 2-3. BLE Coexistence Block Diagram, Dual Antenna.....	7
Figure 2-4. BLE Coexistence With Antenna Diversity and 5-GHz Support.....	8
Figure 2-5. Dual Antenna BLE Coexistence With Antenna Diversity and 5-GHz Support.....	9
Figure 2-6. BLE Coexistence With Antenna Diversity and 2.4-GHz Support.....	10
Figure 3-1. Enabling BLE Coexistence From the Image Creator GUI.....	11
Figure 4-1. Shared Antenna Test Setup.....	14
Figure 4-2. Dual Antenna Test Setup.....	14
Figure 4-3. BLE Throughput During Wi-Fi® TCP Rx.....	15
Figure 4-4. BLE Throughput During Wi-Fi® TCP Tx.....	16
Figure 4-5. BLE Throughput During Wi-Fi® UDP Rx.....	16
Figure 4-6. BLE Throughput During Wi-Fi® UDP Tx.....	17
Figure 4-7. BLE Missed Events, Central Use-Case.....	18

Figure 4-8. BLE CRC Errors, Central Use-Case.....	18
Figure 4-9. BLE Connection Losses, Central Use-Case.....	19
Figure 4-10. TCP Rx Throughput.....	20
Figure 4-11. TCP Tx Throughput.....	20
Figure 4-12. UDP Rx Throughput.....	21
Figure 4-13. UDP Tx Throughput.....	22

### List of Tables

Table 1-1. Terminology.....	4
Table 3-1. CC313x Pin Selection for Coexistence.....	12
Table 3-2. CC323x Pin Selection for Coexistence.....	12

### Trademarks

SimpleLink™, Texas Instruments™, BoosterPack™, and LaunchPad™ are trademarks of Texas Instruments.

Wi-Fi® is a registered trademark of Wi-Fi Alliance.

Bluetooth® is a registered trademark of Bluetooth SIG Inc..

All other trademarks are the property of their respective owners.

## 1 Introduction

The BLE coexistence functionality in the SimpleLink™ CC3x3x family of solutions helps in designing a product that uses both Wi-Fi® and BLE. Although the mechanism is designed to implement coexistence with any BLE device, this document also describes the implementation of the mechanism with Texas Instruments™ SimpleLink™ CC26xx ultra-low power wireless MCU for Bluetooth® low energy.

BLE and Wi-Fi® operate on the same frequencies, and disturb each other's transmissions and receptions, with no inherent way to avoid it.

Wi-Fi®, however, is more inherently tolerant of time-domain disturbances. With this in mind, the co-existence mechanism gives priority to the BLE entity over the Wi-Fi®, as the Wi-Fi® can often delay its transmission or miss a reception, without having any major noticeable effect apparent to the user (to some extent). This is done by connecting the GPIO used by BLE, to control the RF switch to the Wi-Fi® device. This GPIO goes high during any BLE RF activity (transmission or reception), signaling the Wi-Fi® to delay pending transmissions until the signal goes down. A second GPIO may optionally be used when an RF switch is included in the design for a single-antenna use-case. This second GPIO is used to control the RF switch. See [Figure 1-1](#) for an overview of the implementation.

From a Wi-Fi® perspective, the co-existence mechanism resides in ROM, thus it does not require anything from the user-application, apart from enabling or disabling it through a user API, or pre-programming it using the programming tool.

Because the BLE operates only on the 2.4-GHz band, the co-existence mechanism does not affect the 5-GHz band. Wi-Fi® can operate normally on the 5-GHz band while the BLE works on the 2.4-GHz band without any mutual interference; thus a co-existence mechanism is not required.

### 1.1 System Block Diagram

The coexistence mechanism uses a shared antenna between the two 2.4-GHz entities, incorporating an RF switch to toggle between the two. [Figure 1-1](#) shows a high-level schematic of this configuration.

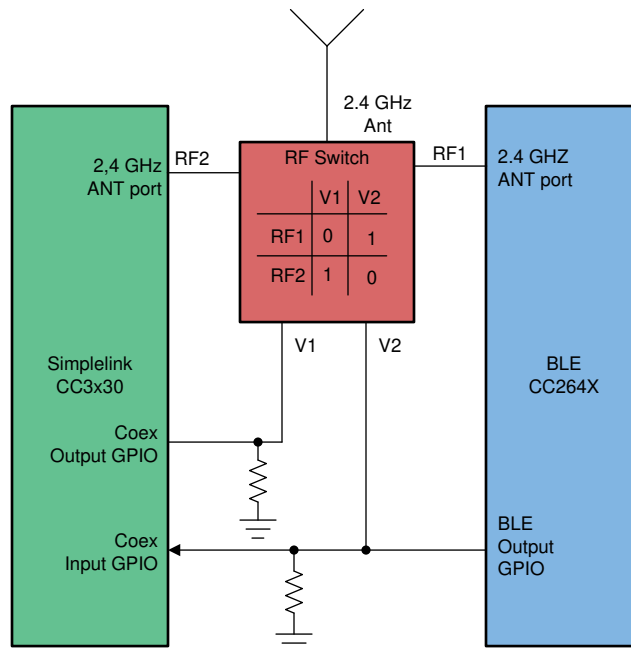

**Figure 1-1. System Block Diagram**

The required GPIOs for the coexistence mechanism can be selected from a wide range of available options; the design options may be limited when using CC323x device variants, where some GPIOs may be allocated to specifically required peripherals. See [Section 3.3](#) for details.

## 1.2 Terminology and Abbreviations

**Table 1-1. Terminology**

Term	Definition
BLE	Bluetooth® Low Energy
WLAN	Wireless-LAN

## 2 Requirements

### 2.1 System Requirements

The following requirements must be fulfilled for proper system functionality using the coexistence mechanism:

- Both devices must share the same I/O supply.
- The CC3x3x device must be powered when the other device is powered, though it may remain in any power state including shutdown.
- A pull-down resistor is required on the input pin to the CC3x3x device, so that there is always a defined state when the other side is off or in power-saving mode. TI recommends also adding a pull-down resistor on the output GPIO, for a total of two 100-K $\Omega$  pull-down resistors, one on each control pin of the RF switch.
- When the RF calibrations mode is set to Normal, the BLE device must be idle when starting the Wi-Fi® core to avoid having the calibrations done in conjunction with the coexistence mechanism, which may cause excessive current due to calibration retries, or possibly failure to initialize altogether if the Wi-Fi® did not get any time allocated for calibrations.
- Some small amount of leakage current is drawn by the pull-down resistors (typically 33  $\mu$ A for a 100-K $\Omega$  pull-down resistor at 3.3-V VBAT voltage) while transmitting or receiving from either device, as well as the current drawn by the RF switch, in a shared antenna design.

### 2.2 BLE Requirements

This section refers to the BLE MCU that the CC3x3x device must coexist with. That device should provide the following:

- Greater than 20-dB isolation from the Wi-Fi®, either by using an RF switch which provides more than 20-dB isolation, or by isolation on the board between the two antennas when using a dual antenna configuration.
- A control GPIO that wraps the device's RF activity (padding of more than 100  $\mu$ S before the RF activity begins).

Figure 2-1 shows the timing diagram for the coexistence signaling. This figure is not drawn to scale.

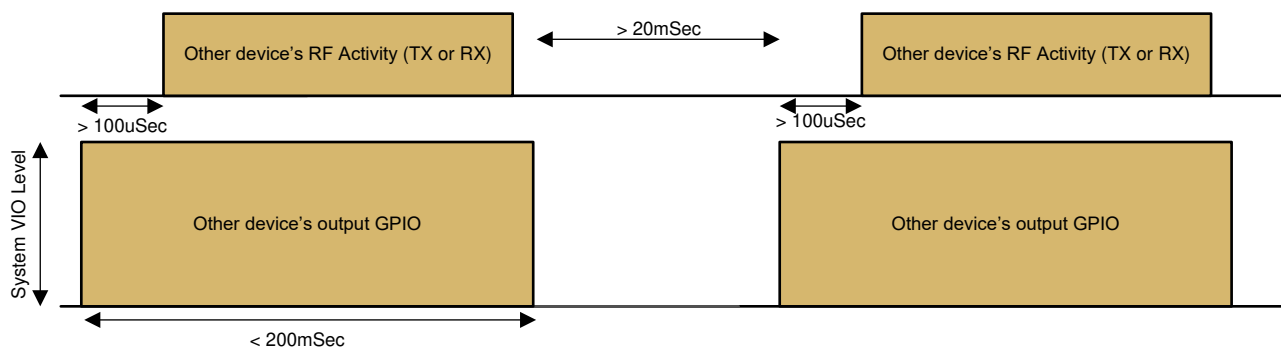
**Figure 2-1. Coexistence Signaling Timing Diagram**

The duration of the BLE's RF activity is not explicitly given, but should be kept within reasonable boundaries so as not to impact Wi-Fi® connection.

## 2.3 BLE Connection Parameters

The BLE device can be used as a peripheral or a central, using most of the connection intervals available, while keeping in mind that the lower the connection interval is, the more impact it has on the Wi-Fi® side, as the BLE takes precedence when using the coexistence mechanism.

For optimal Wi-Fi® performance, TI recommends keeping the BLE RF activity periods at least 100 ms apart. If the Wi-Fi® application relies more on transmissions than receptions, this interval can be lowered down to 20 ms. For lower intervals, the Wi-Fi® connection may be impacted; when BLE is receiving, the antenna is still allocated to it, but it still allows the Wi-Fi® to receive data (in reduced power), while transmissions are not allowed while the BLE side is receiving or transmitting.

Also, the shorter the BLE time interval is, the higher impact it has on the overall system current consumption, as it delays the Wi-Fi® core more frequently.

## 2.4 User Application Requirements

This section refers to the CC323x device variants which incorporate the internal MCU. The configured coexistence I/Os are handled by the internal firmware of the device, and can be considered an extra peripheral when enabled; the user configuration can still be destructive, however, if it attempts to override the firmware configuration.

If the user application configures an I/O selected for coexistence purposes prior to starting the Wi-Fi®, the Wi-Fi® will fail to initialize and an error is returned to the user. If the user application configures an I/O after the Wi-Fi® has been started, it will stop the coexistence mechanism from operating properly. Specifically, the pads selected to be used as the coexistence interface must not be multiplexed to any other functionality (either user GPIO or peripheral).

To prevent disruptions to the user application, maximum flexibility is given to the user to choose the most fitting pads for the coexistence task.

## 2.5 Wi-Fi® Requirements

The coexistence mechanism can operate in any supported Wi-Fi® mode (AP, station, P2P, and transceiver). It does not interfere with 5-GHz transmissions; when using 5-GHz channels, the coexistence has no impact on Wi-Fi® performance.

## 2.6 System Configurations

Various system configurations that include the coexistence mechanisms may be used in the CC3x3x devices.

### 2.6.1 2.4-GHz / 5-GHz Wi-Fi® With BLE Coexistence (CC3x35 only)

This is the default setting for a CC3135/CC3235x device with BLE coexistence enabled. The RF switch must have at least 20 dB attenuation for the deselected path.

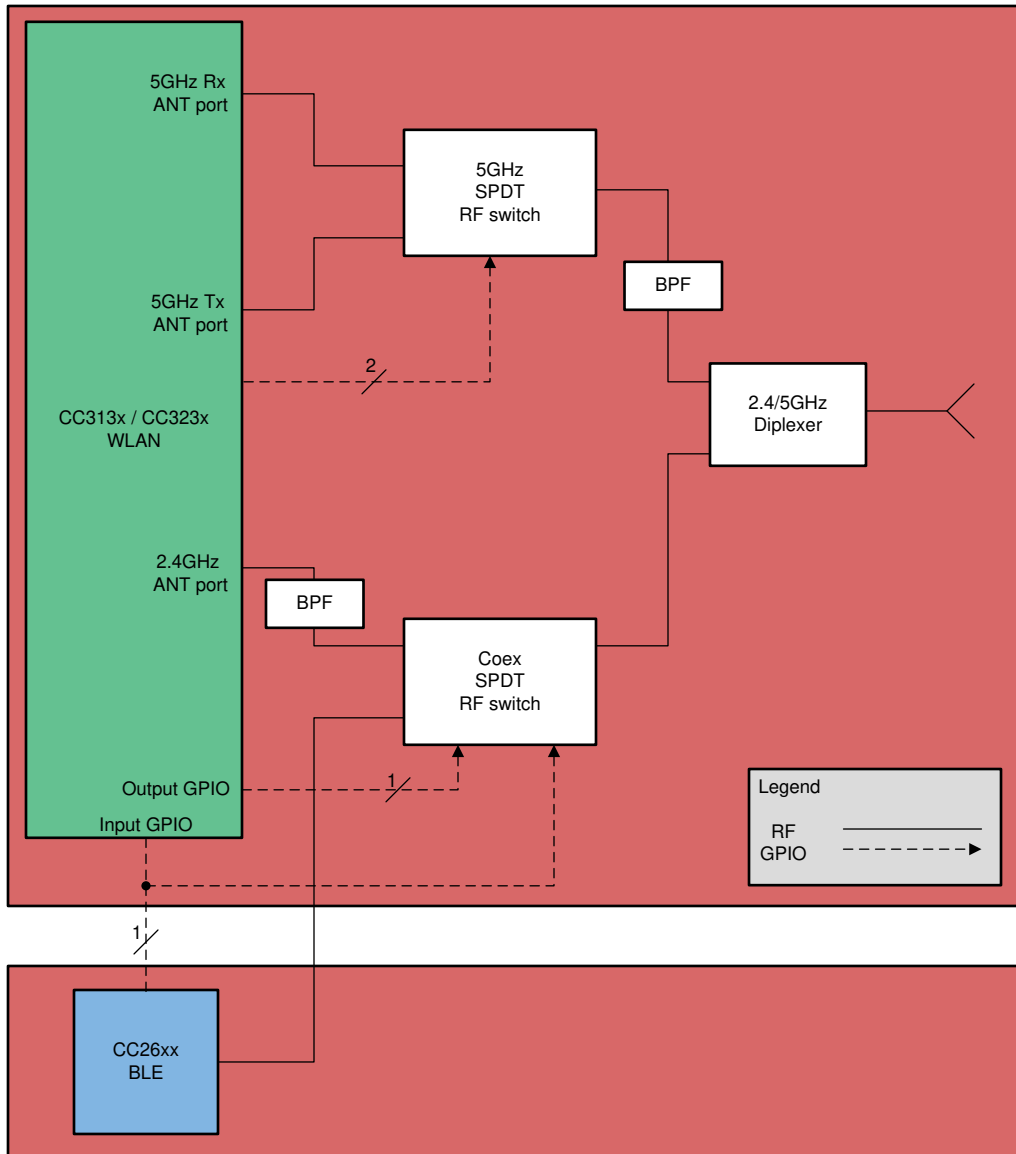
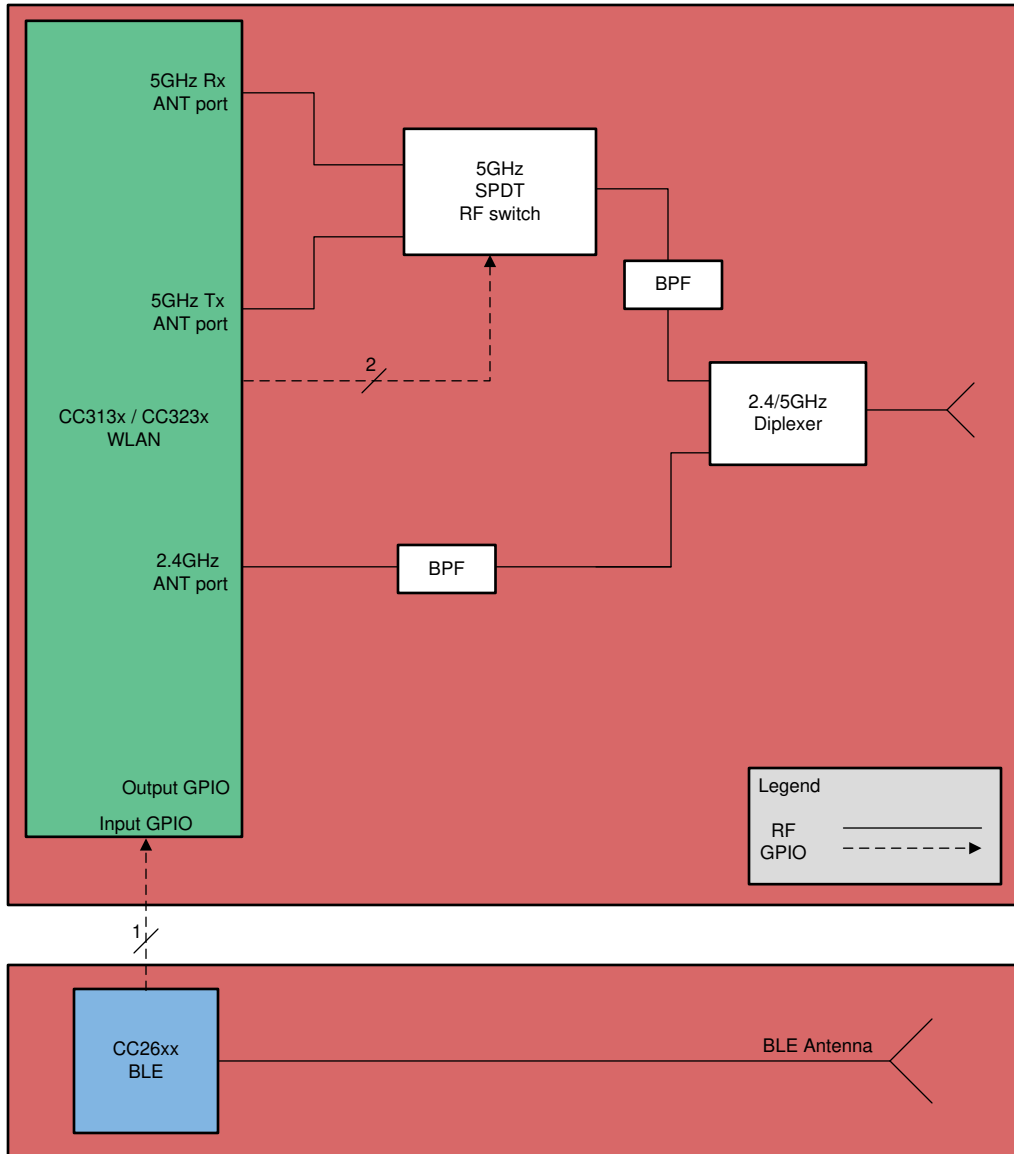

Figure 2-2. BLE Coexistence Block Diagram

**2.6.2 2.4-GHz / 5-GHz Wi-Fi® With BLE Coexistence, Dual Antenna (CC3x35 only)**

When both the BLE device and the Wi-Fi® device have their own antenna, an RF switch to toggle between them is not required. In this case, only one GPIO is used to signal the Wi-Fi® when the BLE uses the air, during which the Wi-Fi® does not initiate new transmissions, but is still capable of data reception.



**Figure 2-3. BLE Coexistence Block Diagram, Dual Antenna**

**2.6.3 2.4-GHz / 5-GHz Wi-Fi® With BLE Coexistence, With Antenna Diversity (CC3x35 only)**

This configuration includes antenna diversity in conjuncture with BLE coexistence. An additional 2 GPIOs are required for the diversity RF switch control. Also, RF degradation occurs due to the RF switches along the RF chain.

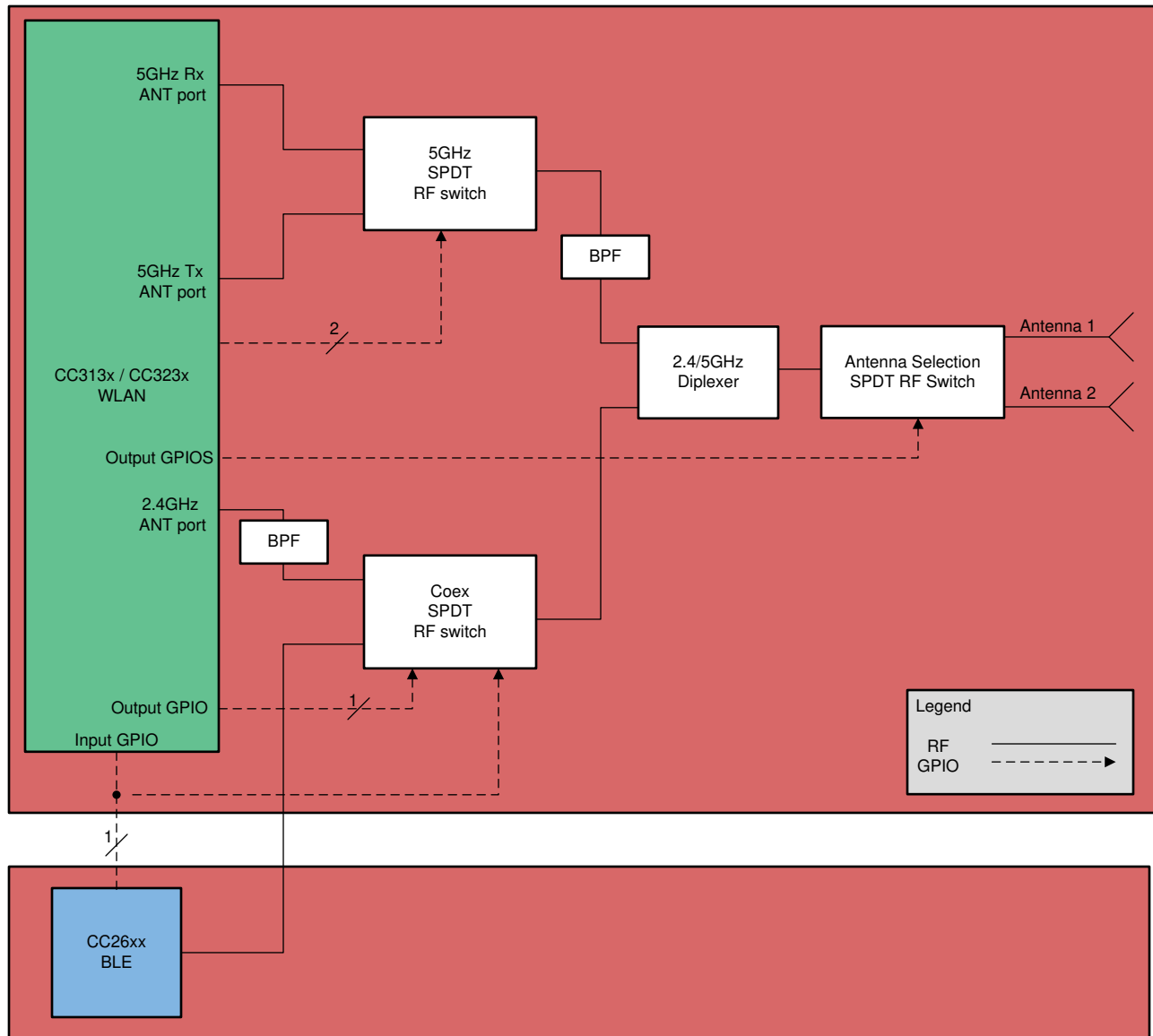

**Figure 2-4. BLE Coexistence With Antenna Diversity and 5-GHz Support**



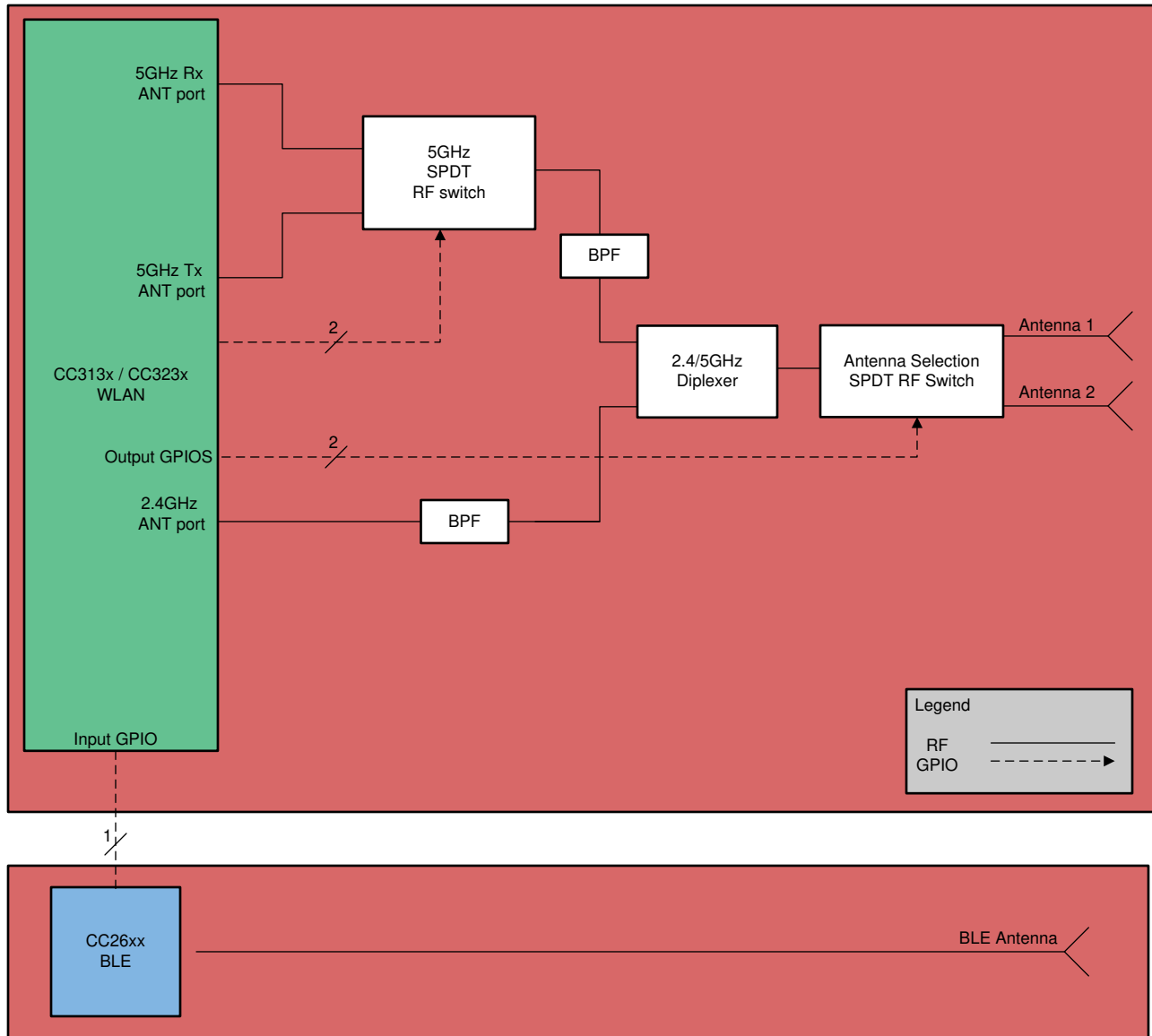

Figure 2-5. Dual Antenna BLE Coexistence With Antenna Diversity and 5-GHz Support

### 2.6.4 2.4-GHz Only Wi-Fi® With BLE Coexistence and Antenna Diversity Support (CC3x30)

If 5-GHz support is not required, the following scheme allows antenna diversity alongside BLE coexistence.

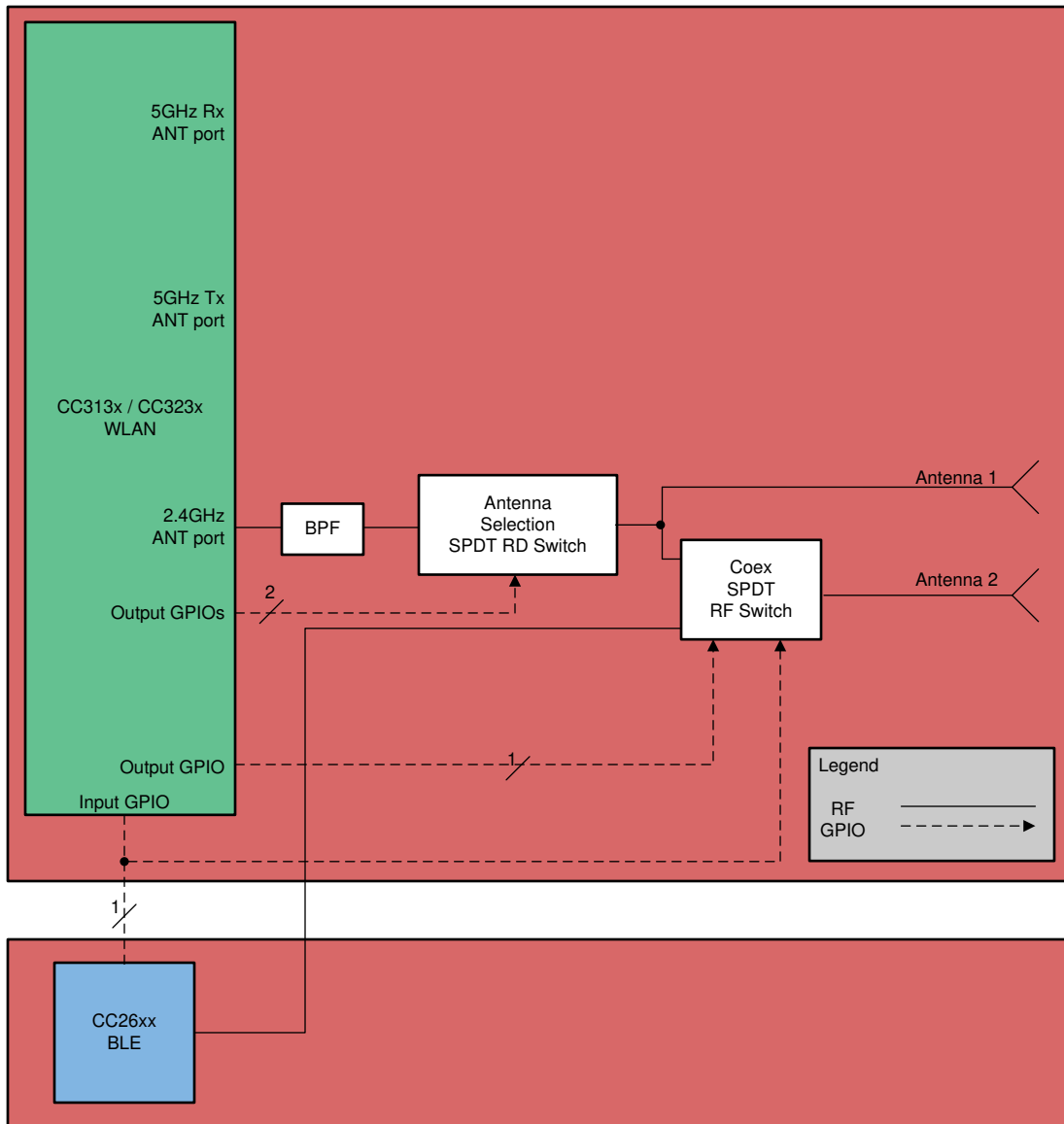
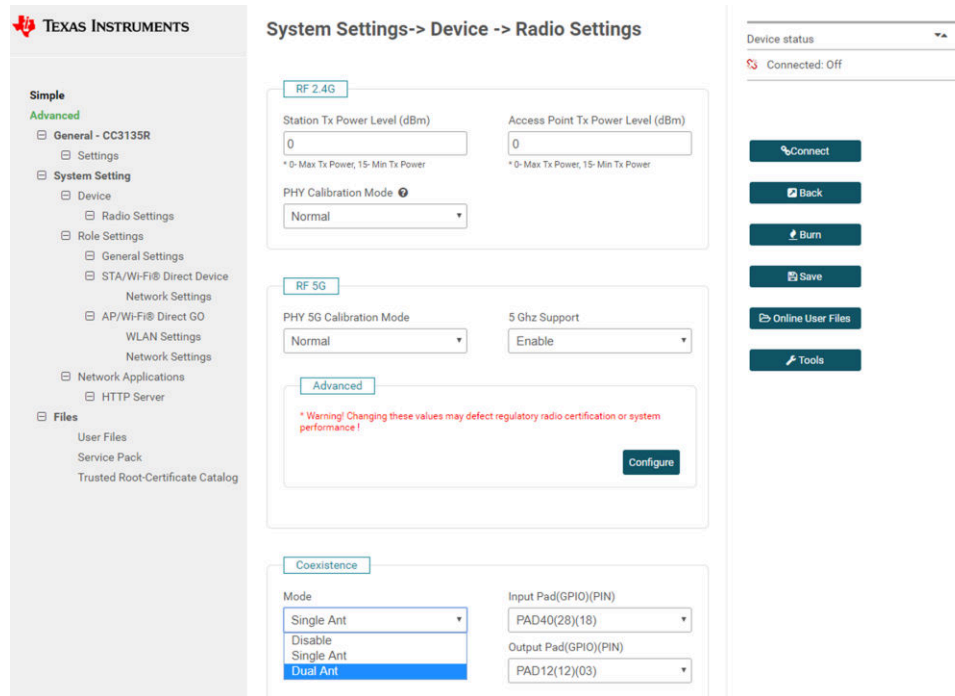

Figure 2-6. BLE Coexistence With Antenna Diversity and 2.4-GHz Support

## 3 Enabling BLE Coexistence Capability

### 3.1 Using the Image Creator

Enabling BLE coexistence can be done from the Image Creator GUI when programming the device. The selection is done under System Settings → Device → Radio Settings, as shown in [Figure 3-1](#).



**Figure 3-1. Enabling BLE Coexistence From the Image Creator GUI**

First select the mode:

- Off – BLE coexistence is not used (default)
- Single antenna – choose this option when the platform includes an RF switch, to share a single antenna between the BLE and Wi-Fi®. This option requires the allocation of two GPIOs – one is input from the BLE and to the RF switch, the other is an output from the Wi-Fi® to the RF switch (see [Figure 1-1](#)).
- Dual antenna – choose this option when the platform has separate antennas for BLE and Wi-Fi®. In this mode, BLE signals Wi-Fi® when it requires the channel, and Wi-Fi® stops ongoing transmissions during those times.

### 3.2 Using an API

BLE coexistence can be enabled, disabled, or modified using an API from the host. The settings require restarting the Wi-Fi® to take effect.

The configuration can be applied using the `sl_WlanSet` command, with ConfigId of `SL_WLAN_CFG_GENERAL_PARAM_ID` and ConfigOpt of `WLAN_GENERAL_PARAM_COEX_CONFIG`.

The data structure is as follows:

```
typedef struct
{
    UINT8 Mode;
    UINT8 InputPad;
    UINT8 OutputPad;
    UINT8 Reserved;
    UINT32 Options;
}SlWlanCoexConfig_t;
```

Mode can accept the following values: 0, 1, and 2 (for disabled, enabled single antenna, and enabled dual antenna, respectively).

The input pad and output pad can accept pad number (only pad numbers, not pin numbers); up to 40, inclusive. The Reserved and Option fields should remain 0.

### 3.3 Pad Selection

To allow maximum flexibility for every platform configuration, there are multiple choices for assigning the coexistence interface on the device pins. These choices differ slightly, based on the device family (CC313x versus CC323x).

[Table 3-1](#) lists the available pins that can be used for coexistence in the CC313x device, and [Table 3-2](#) lists the pins that can be used for coexistence in the CC323x device.

**Table 3-1. CC313x Pin Selection for Coexistence**

PAD Name	Pin Number	Comment
PAD04	59	Output only
PAD05	60	
PAD08	63	
PAD09	64	Default coexistence input pin on BoosterPack™ module
PAD10	1	
PAD12	3	Default coexistence output pin on BoosterPack module
PAD13	4	
PAD25	21	Shared with SOP2, output only
PAD26	29	Default for Antenna Selection on BoosterPack module
PAD27	30	Default for Antenna Selection on BoosterPack module
PAD40	18	

**Table 3-2. CC323x Pin Selection for Coexistence**

PAD Name	Pin Number	Comment
PAD03	58	Output only. Default coexistence output on LaunchPad™ kit
PAD04	59	Output only
PAD05	60	
PAD06	61	
PAD08	63	
PAD09	64	
PAD10	1	
PAD11	2	Output only
PAD12	3	
PAD13	4	
PAD14	5	
PAD15	6	
PAD16	7	
PAD17	8	Output only
PAD22	15	
PAD25	21	Shared with SOP2, output only
PAD26	29	Default for Antenna Selection on LaunchPad kit
PAD27	30	Default for Antenna Selection on LaunchPad kit
PAD40	18	Default coexistence input on LaunchPad kit

## 4 Test Results

### 4.1 Test Setup Description

This setup checks the ability to receive and send Wi-Fi® traffic without interference with a BLE connection transferring data. During the test, both Wi-Fi® and BLE traffic is sent at maximum throughput. The Wi-Fi® RF attenuation is gradually raised while the Wi-Fi® throughput, BLE throughput, BLE events, BLE missing events, BLE CRC errors, and BLE lost connections are monitored.

This section explains the relevant calibrations required to achieve the results shown in this document.

All of the devices (access point, SimpleLink™ Wi-Fi®, and the BLE device) are placed in an RF chamber, and the connections are made using an RF chain.

#### 4.1.1 BLE Side

##### 4.1.1.1 RF Chain

During the test, the RSSI in the BLE device is between  $-46$  to  $-50$  dBm. Between the RF splitter A and the BLE device B, there is an attenuation of 16 dB in dual antenna mode. In shared antenna mode, the attenuation is 4 dB. This difference in the attenuation creates a situation where the BLE device is protected from Wi-Fi® traffic from other sources.

Additionally, the BLE attenuation value is changed according to the coexistence mode. With this attenuator, the user can change set the attenuation to assure the desired RSSI. The RF splitter A has an attenuation of 12 dB, and the RF splitter B has an attenuation of 6 dB in this setup.

##### 4.1.1.2 Application

When both BLE devices are connected, one of them is central and the other is a peripheral. They transfer data in rate of 1 Mbps and intervals of 100 ms and 50 ms.

This test uses the BLE CC26xx devices, using the example application of the SDK with a few changes. These changes were made to make the BLE device work in the most extreme conditions, to show the ability to assure a stable BLE connection. The relevant changes are: the connection interval is set to a single value without allowing the BLE device to change, the slave latency is 0, and the connection timeout is set to 3 miss interval.

#### 4.1.2 Wi-Fi® Side

The access point is configured to work in channel 11 with a TX power of 17 dBm, with no security.

Between the access point and the Wi-Fi®, there is a fixed attenuation of 55 dB, including all the elements in the RF chain up to the RF Splitter B. If the coexistence mode is shared antenna, an additional 6 dB attenuation is added before the RF switch. If the coexistence mode is dual antenna, the attenuation of the RF splitter should be 6 db. An extra attenuator may be used if the splitter is not with the relevant attenuation. At the beginning of the test, start with an attenuation of 67 dB; this extra attenuation is reached using the Wi-Fi® attenuator.

The X-axis of all the result graphs is the Wi-Fi® attenuation between the AP and the SL device.

[Figure 4-1](#) and [Figure 4-2](#) describe the test setups.

Wi-Fi® runs in station mode, TCP RX, TCP TX, UDP RX, and UDP TX traffic (maximum throughput), in all supported coexistence modes:

- Coexistence off
- Coexistence on

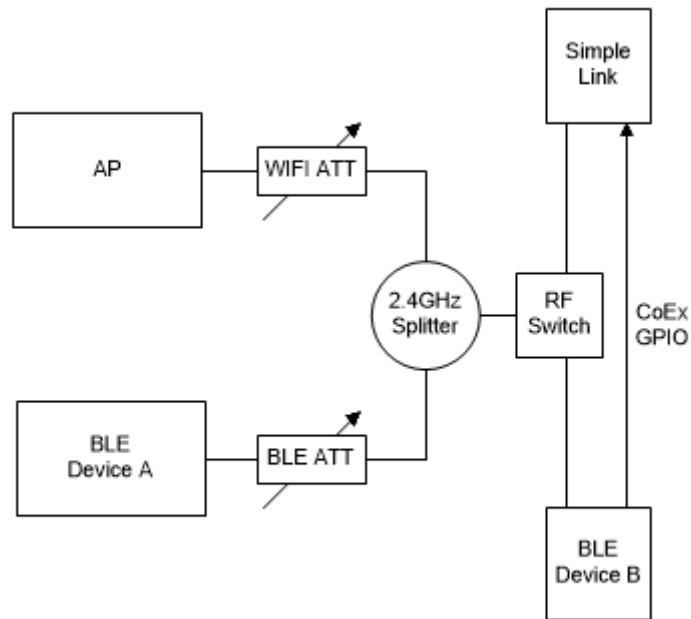

Figure 4-1. Shared Antenna Test Setup

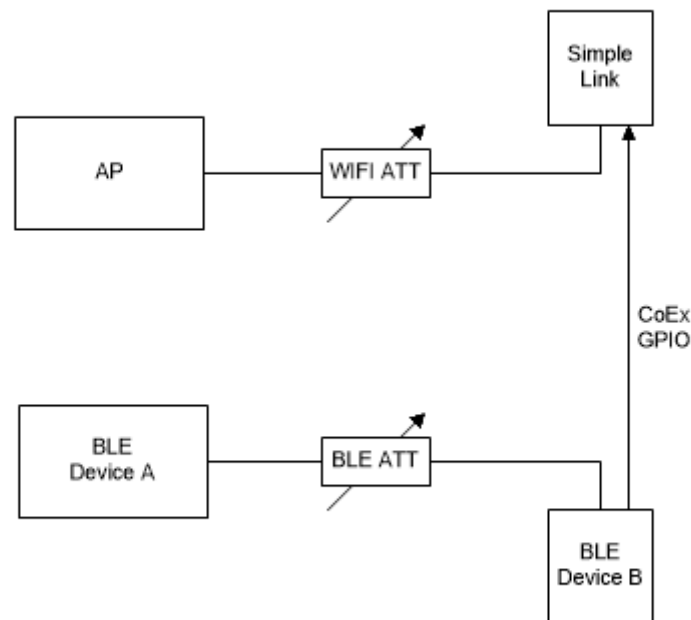
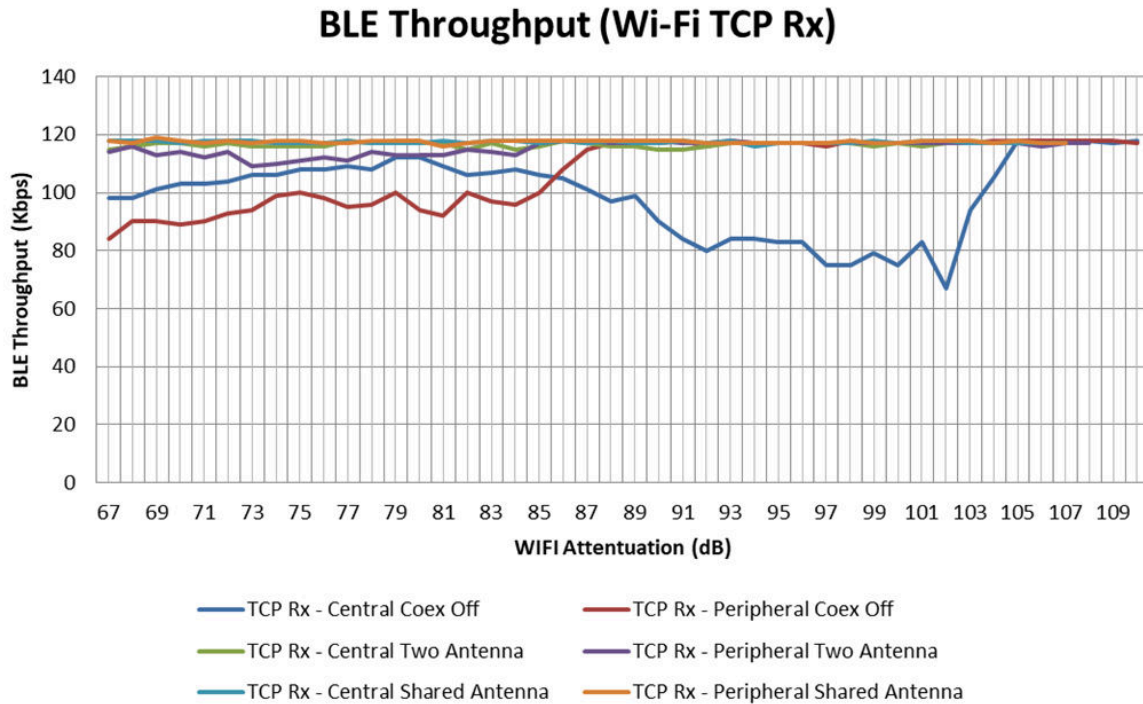

Figure 4-2. Dual Antenna Test Setup

### 4.2 Test Results – Wi-Fi® Throughput Impact on BLE Throughput

All tests in this section have the BLE configured to a 100-ms connection interval, and the Wi-Fi® side is measured using the CC3235S device.

Figure 4-3 shows that the BLE throughput is impacted when the coexistence mechanism is turned off. With the coexistence turned on, BLE throughput is hardly impacted by the Wi-Fi® traffic.



**Figure 4-3. BLE Throughput During Wi-Fi® TCP Rx**

With the coexistence turned off, BLE throughput is heavily impacted by the Wi-Fi® TX traffic. With it turned on, there is hardly any impact on BLE throughput. The knee at high attenuation is caused by the Wi-Fi® disconnecting from the AP.

### BLE Throughput (Wi-Fi TCP Tx)

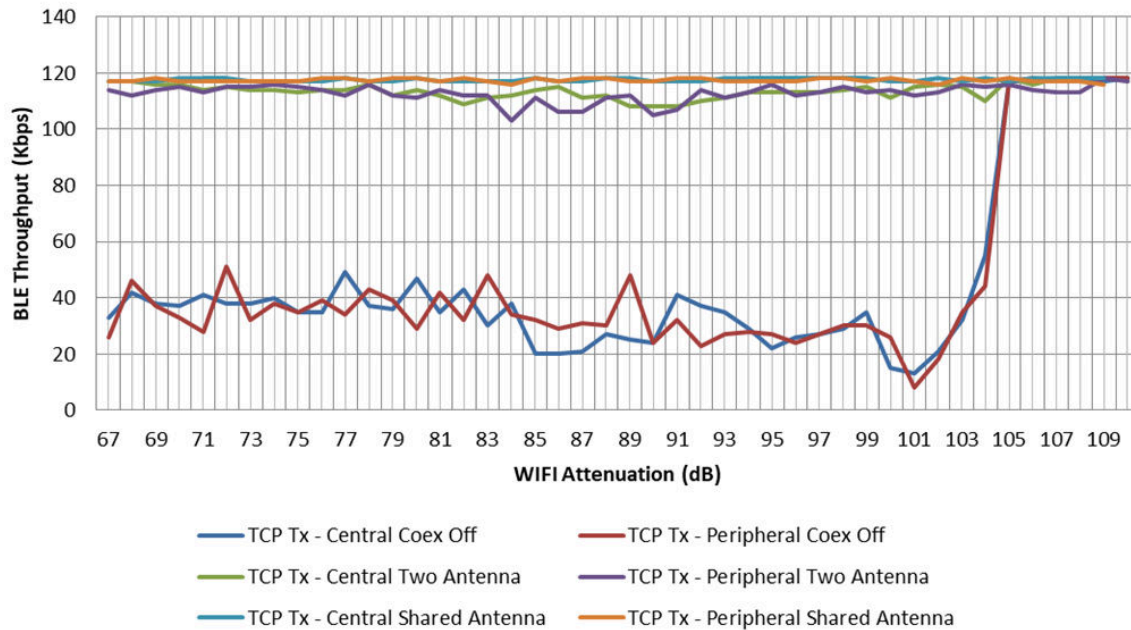

Figure 4-4. BLE Throughput During Wi-Fi® TCP Tx

When coexistence is turned off, there is a degradation of BLE throughput. This degradation does not occur with the mechanism turned on, except for a slight degradation when the Wi-Fi® attenuation is low when using shared antenna (due to RX-RX collisions). The tests conducted with co-existence turned off were using the RF switch, so some attenuation was ensured between the BLE device and the Wi-Fi® access point.

### BLE Throughput (Wi-Fi UDP Rx)

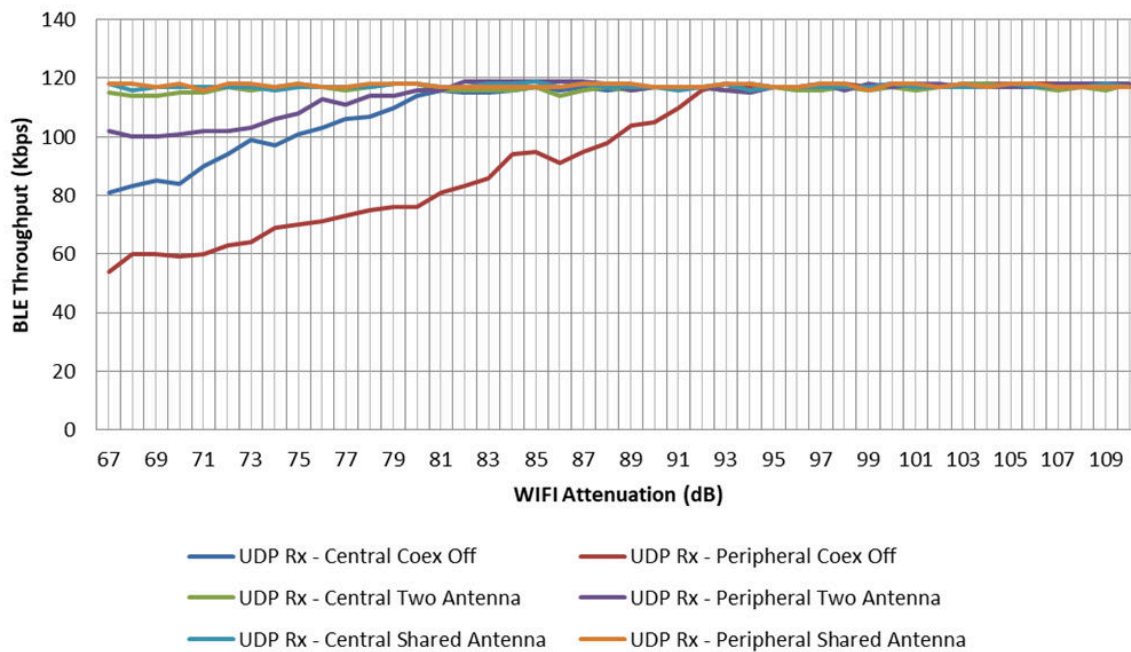

Figure 4-5. BLE Throughput During Wi-Fi® UDP Rx



Figure 4-6 shows no impact on BLE throughput when the coexistence mechanism is active, and heavy degradation when the coexistence is inactive.

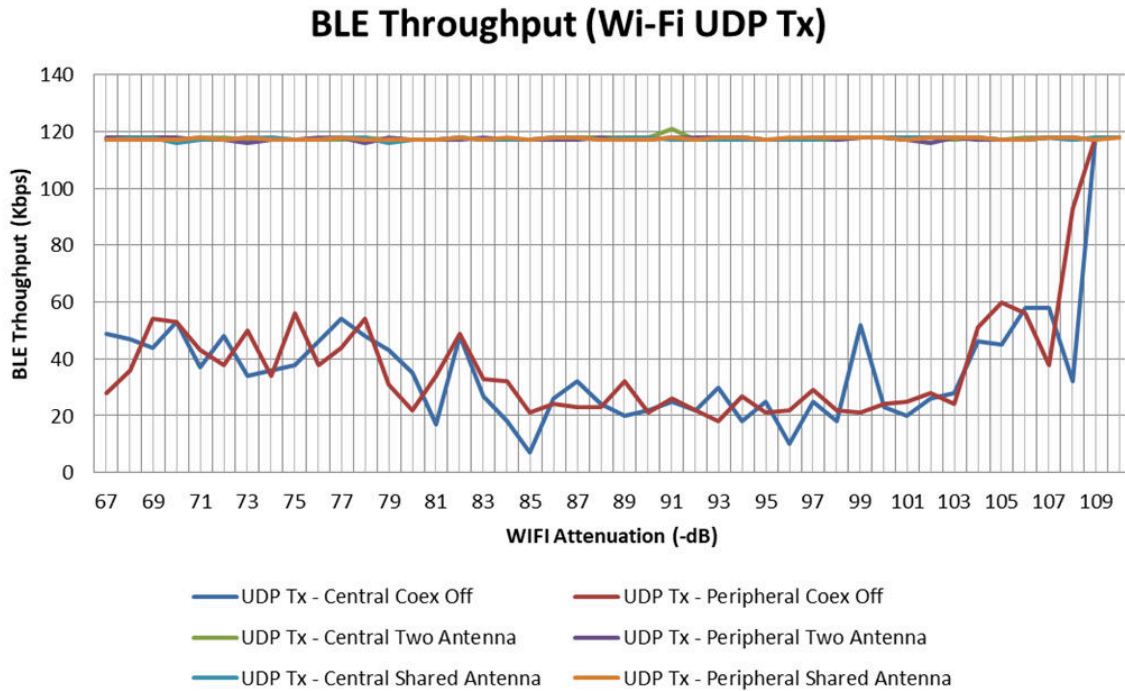

Figure 4-6. BLE Throughput During Wi-Fi® UDP Tx

### 4.3 Test Results – Wi-Fi® Throughput Impact on BLE Connection Quality

Figure 4-7 shows a large number of missed events counted over a period of ~30 seconds for each Wi-Fi® attenuation when the coexistence mechanism is turned off, especially when the Wi-Fi® is transmitting heavily in low attenuations.

At high attenuations, the amount of missed events rises with coexistence turned on; this can be attributed to the Wi-Fi® rate fallback, causing the Wi-Fi® packets to become longer and get re-transmitted frequently.

### BLE Missed Events Central

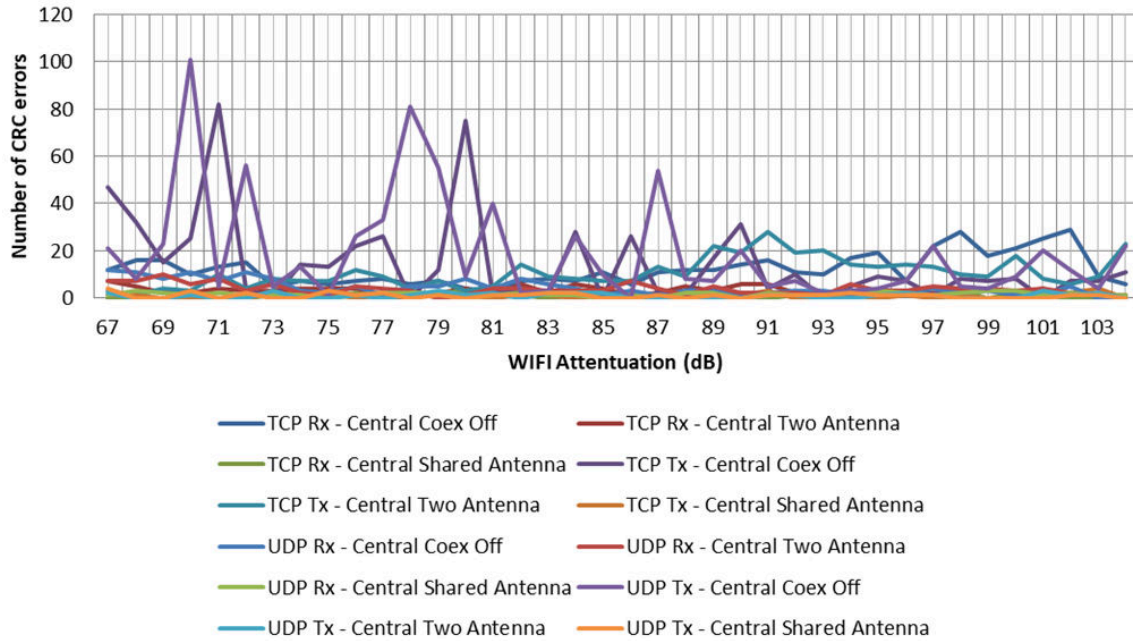

Figure 4-7. BLE Missed Events, Central Use-Case

Figure 4-8 shows the high amount of CRC errors in low Wi-Fi® attenuations when coexistence is turned off. Enabling coexistence almost totally eliminates the measured CRC errors.

The accumulated number of CRC per attenuation is measured over a period of 30 seconds.

### BLE CRC Error Central

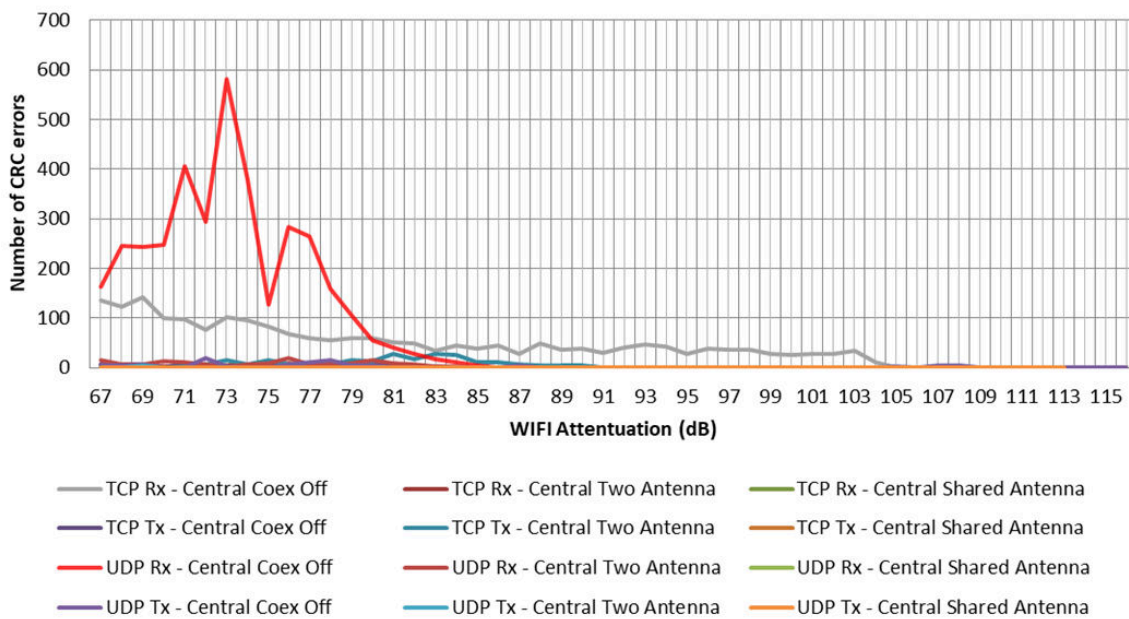

Figure 4-8. BLE CRC Errors, Central Use-Case

Figure 4-9 shows many instances of BLE connection loss when the coexistence mechanism is turned off, with no such occurrences when it is turned on.

### BLE Connection Loss Central

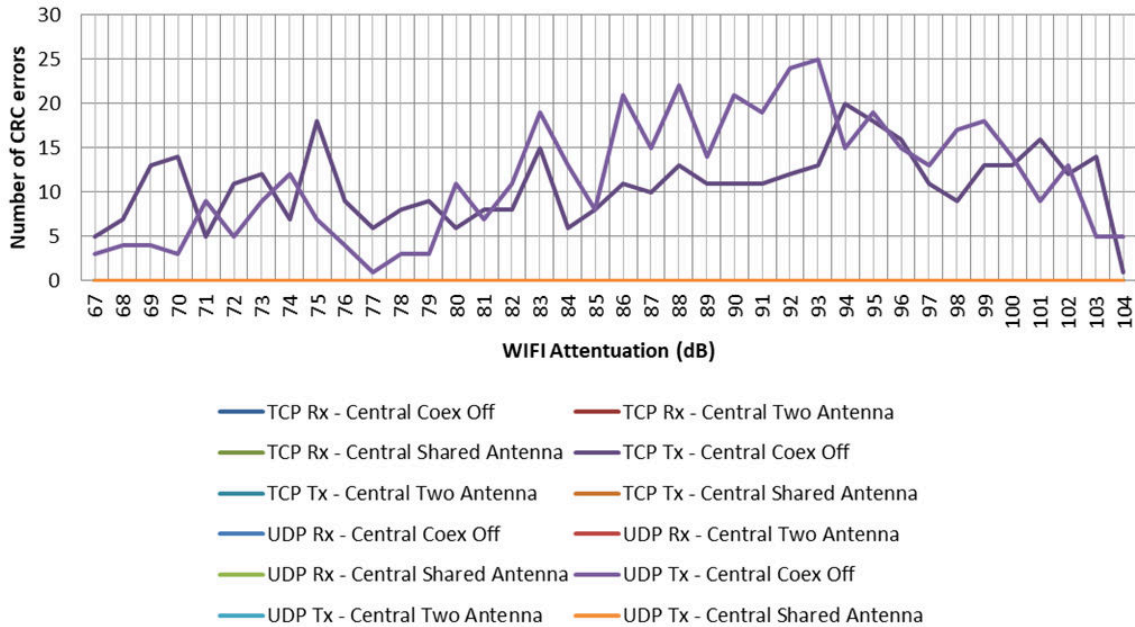

Figure 4-9. BLE Connection Losses, Central Use-Case

#### 4.4 Test Results – BLE Throughput Impact on Wi-Fi® Throughput

Because the Simplelink™ BLE coexistence gives priority to BLE activity, it is expected that the Wi-Fi® performance is impacted by the BLE activity. This section shows this impact is very small, and that Wi-Fi® can still perform well with BLE transferring a large amount of data concurrently.

The tests conducted in this section have the BLE device running throughput in central use-case.

Figure 4-10 shows the baseline TCP Rx throughput, starting at around 18 Mbps, dropping to around 15 Mbps with BLE coexistence turned on, and dropping gradually in all scenarios when attenuation rises (regardless of BLE coexistence), as expected.

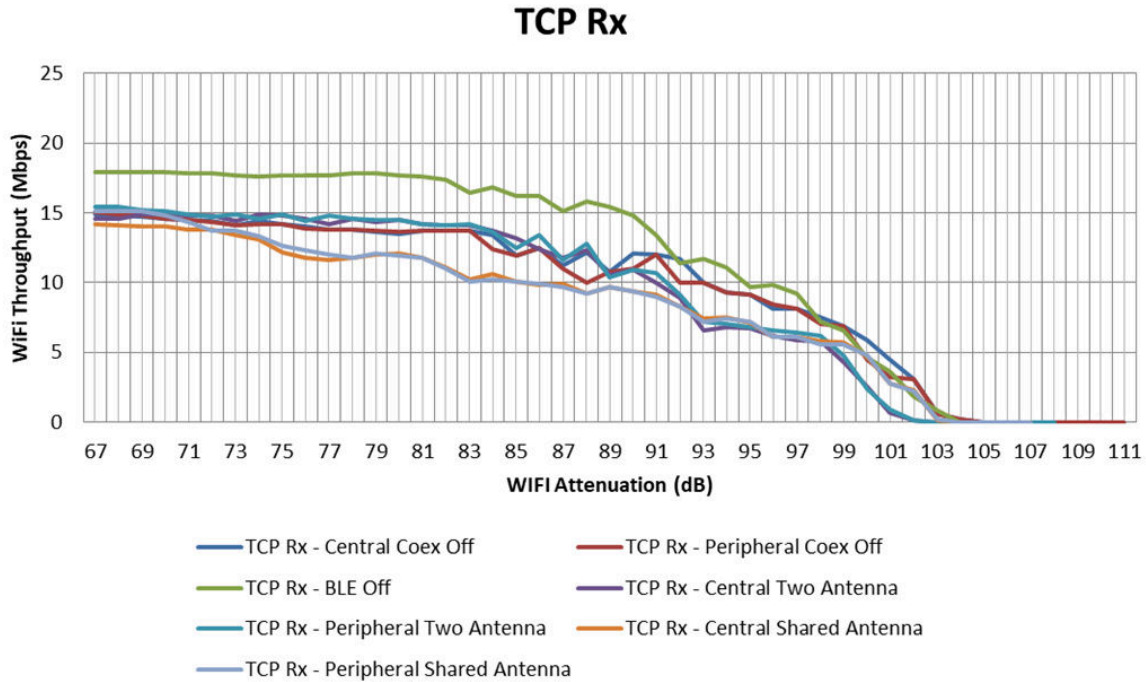

Figure 4-10. TCP Rx Throughput

With TCP, unlike UDP, because of the retransmission mechanism of the Wi-Fi®, the throughput is hardly impacted at all, dropping from 19.3 Mbps (baseline attenuation) to 16.8 Mbps (baseline attenuation) in all co-existence scenarios.

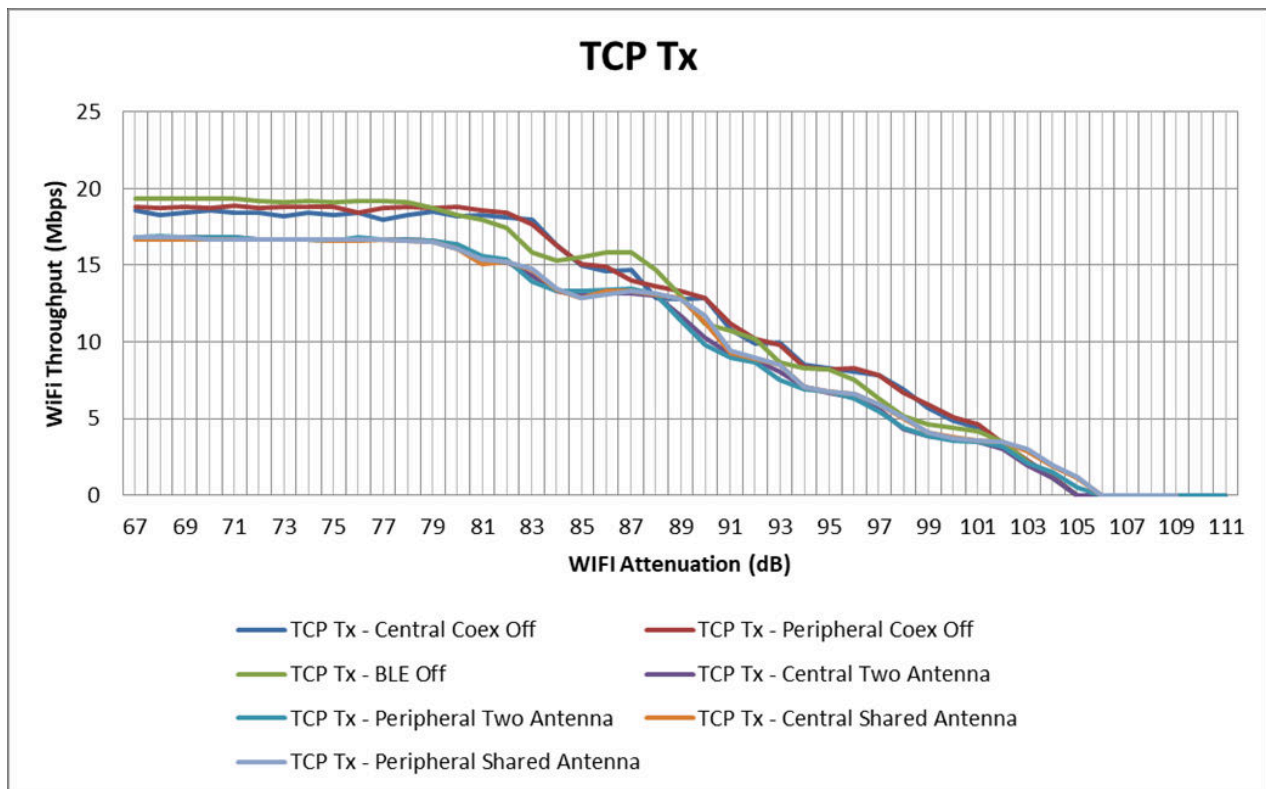
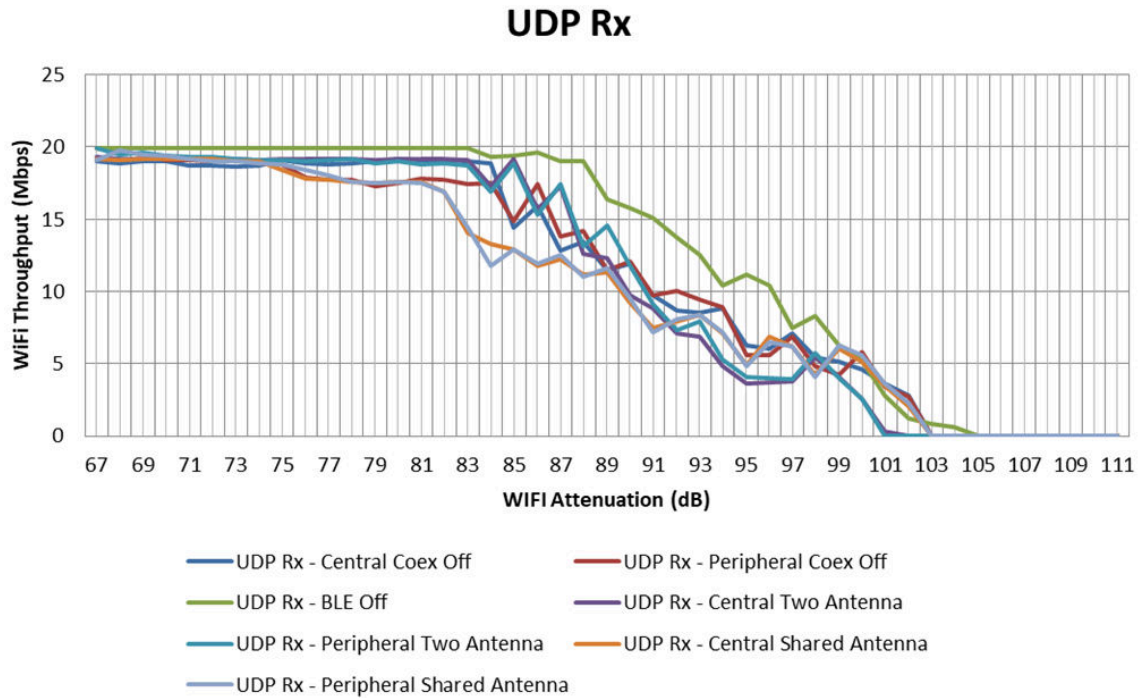

Figure 4-11. TCP Tx Throughput

UDP Rx shows a similar trend; the baseline when BLE is off is not far from the throughput when it is on.



**Figure 4-12. UDP Rx Throughput**

Because Wi-Fi® can delay its transmissions until the antenna is returned to it, and the protocol does not rely on the TCP acknowledgments, this is the easiest use-case for coexistence. As [Figure 4-13](#) shows, the fact that BLE is running throughput concurrently has hardly any impact on the Wi-Fi® throughput, which in this case is around 19 Mbps.

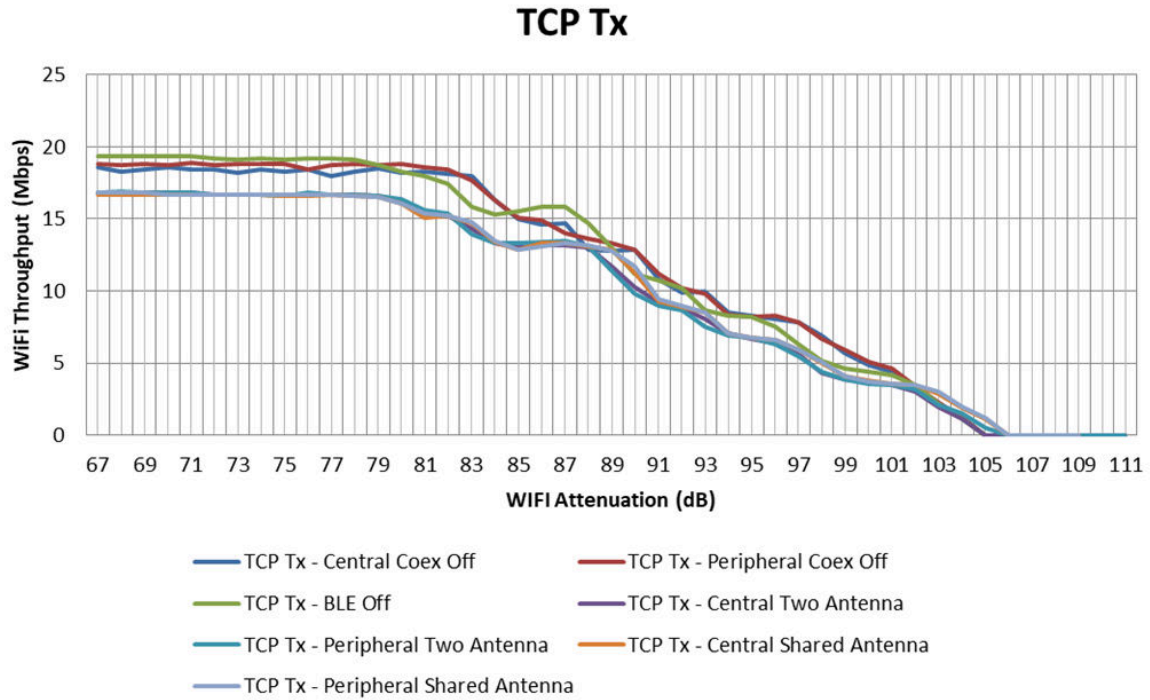

Figure 4-13. UDP Tx Throughput

## 5 Revision History

NOTE: Page numbers for previous revisions may differ from page numbers in the current version.

Changes from Revision * (April 2018) to Revision A (August 2020)	Page
• Changed the document title and throughput document to include CC3130 and CC3230 devices.....	3

## IMPORTANT NOTICE AND DISCLAIMER

TI PROVIDES TECHNICAL AND RELIABILITY DATA (INCLUDING DATASHEETS), DESIGN RESOURCES (INCLUDING REFERENCE DESIGNS), APPLICATION OR OTHER DESIGN ADVICE, WEB TOOLS, SAFETY INFORMATION, AND OTHER RESOURCES "AS IS" AND WITH ALL FAULTS, AND DISCLAIMS ALL WARRANTIES, EXPRESS AND IMPLIED, INCLUDING WITHOUT LIMITATION ANY IMPLIED WARRANTIES OF MERCHANTABILITY, FITNESS FOR A PARTICULAR PURPOSE OR NON-INFRINGEMENT OF THIRD PARTY INTELLECTUAL PROPERTY RIGHTS.

These resources are intended for skilled developers designing with TI products. You are solely responsible for (1) selecting the appropriate TI products for your application, (2) designing, validating and testing your application, and (3) ensuring your application meets applicable standards, and any other safety, security, or other requirements. These resources are subject to change without notice. TI grants you permission to use these resources only for development of an application that uses the TI products described in the resource. Other reproduction and display of these resources is prohibited. No license is granted to any other TI intellectual property right or to any third party intellectual property right. TI disclaims responsibility for, and you will fully indemnify TI and its representatives against, any claims, damages, costs, losses, and liabilities arising out of your use of these resources.

TI's products are provided subject to TI's Terms of Sale ([www.ti.com/legal/termsofsale.html](http://www.ti.com/legal/termsofsale.html)) or other applicable terms available either on [ti.com](http://ti.com) or provided in conjunction with such TI products. TI's provision of these resources does not expand or otherwise alter TI's applicable warranties or warranty disclaimers for TI products.

Mailing Address: Texas Instruments, Post Office Box 655303, Dallas, Texas 75265  
Copyright © 2020, Texas Instruments Incorporated