

## Antenna Selection Guide

By Richard Wallace

### Keywords

- Antenna Selection
- Anechoic Chamber
- Antenna Parameters
- 169 MHz (136 – 240 MHz) Antenna
- 315 MHz (273 – 348 MHz) Antenna
- 433 MHz (387 – 510 MHz) Antenna
- 868 MHz (779 – 960 MHz) Antenna
- 915 MHz (779 – 960 MHz) Antenna
- 2.4 GHz Antenna
- CC-Antenna-DK

### 1 Introduction

This application note describes important parameters to consider when deciding what kind of antenna to use in a short range device application.

Important antenna parameters, different antenna types, design aspects and techniques for characterizing antennas are presented. Radiation pattern, gain, impedance matching, bandwidth, size and cost are some of the parameters discussed in this document.

Antenna theory and practical measurement are also covered.

In addition different antenna types are presented, with their pros and cons. All of the antenna reference designs available on [www.ti.com/lpw](http://www.ti.com/lpw) are presented including the Antenna Development Kit [29].

The last section in this document contains references to additional antenna resources such as literature, applicable EM simulation tools and a list of antenna manufacturer and consultants.

Correct choice of antenna will improve system performance and reduce the cost.

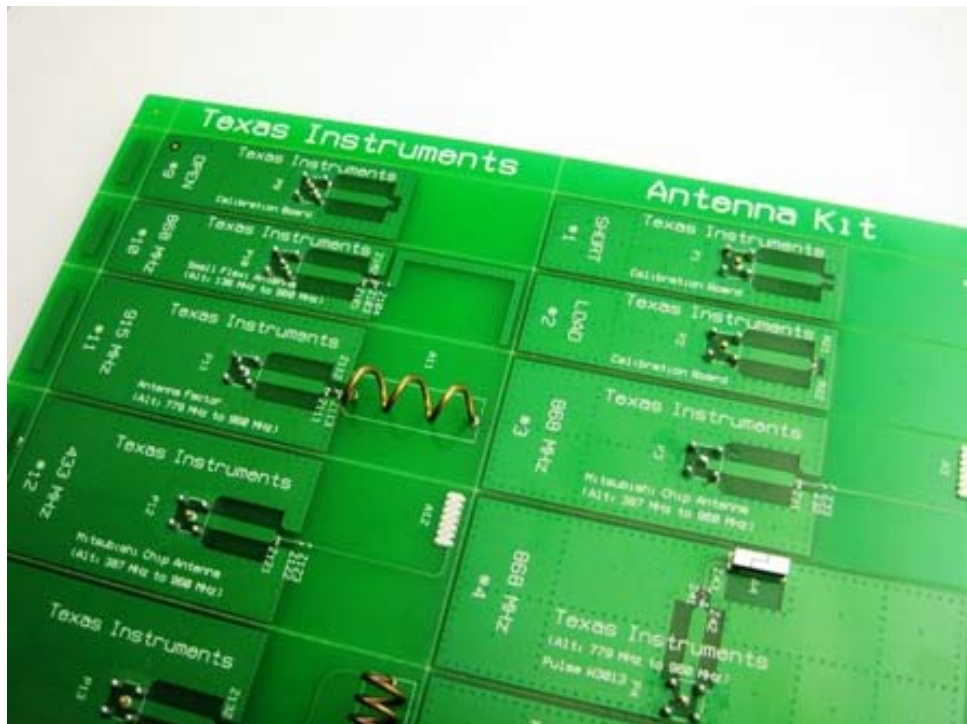

Figure 1. Texas Instruments Antenna Development Kit (CC-Antenna-DK)

## Table of Contents

<b>KEYWORDS</b>	<b>1</b>
<b>1 INTRODUCTION</b>	<b>1</b>
<b>2 ABBREVIATIONS</b>	<b>3</b>
<b>3 BRIEF ANTENNA THEORY</b>	<b>4</b>
3.1 DIPOLE ( $\lambda/2$ ) ANTENNAS	4
3.2 MONOPOLE ( $\lambda/4$ ) ANTENNAS	5
3.3 WAVELENGTH CALCULATIONS FOR DIPOLE IN FREE SPACE	5
3.4 MAXIMUM POWER TRANSFER (VSWR)	6
3.5 ANTENNA PERFORMANCE CONSIDERATIONS	7
3.6 FRIIS TRANSMISSION EQUATION	7
<b>4 ANTENNA TYPES</b>	<b>8</b>
4.1 PCB ANTENNAS	10
4.1.1 <i>TI Antenna Reference Designs</i>	10
4.1.2 <i>IP Based</i>	10
4.2 CHIP ANTENNAS	11
4.3 WHIP ANTENNAS	11
4.4 WIRE ANTENNAS	11
<b>5 ANTENNA PARAMETERS</b>	<b>12</b>
5.1 RADIATION PATTERNS	12
5.1.1 <i>Polarization</i>	15
5.1.2 <i>Ground Effects</i>	16
5.2 DIRECTIONAL ANTENNAS	17
5.3 SIZE, COST AND PERFORMANCE	17
<b>6 ANTENNA MEASUREMENTS</b>	<b>18</b>
6.1 MEASURING BANDWIDTH WITH A SPECTRUM ANALYZER	18
6.2 MEASURING RL, IMPEDANCE AND BANDWIDTH WITH A NETWORK ANALYZER	19
6.2.1 <i>Mounting of cable for S11 measurements</i>	19
6.2.2 <i>Calibration</i>	20
6.2.3 <i>Placement of the Device under Test</i>	21
6.2.4 <i>Interpreting Measurement Results</i>	21
6.2.5 <i>Antenna Matching</i>	23
6.3 OVER-THE-AIR (OTA) MEASUREMENTS	24
<b>7 ANTENNA REFERENCE DESIGNS AVAILABLE ON WWW.TI.COM/LPW</b>	<b>26</b>
7.1 CC-ANTENNA-DK REFERENCE DESIGNS	26
7.2 2.4 GHZ ANTENNA REFERENCE DESIGNS	27
7.2.1 <i>Single Ended Antennas</i>	27
7.2.2 <i>Differential Antennas</i>	29
7.2.3 <i>YAGI PCB Directional Antenna</i>	30
7.3 SUB 1 GHZ ANTENNA REFERENCE DESIGNS	31
7.3.1 <i>Reference Designs for 868/915/955 MHz Antennas</i>	31
7.3.2 <i>Reference Designs for 433 MHz Antennas</i>	35
7.3.3 <i>Reference Designs for 315 MHz Antennas</i>	36
7.3.4 <i>Reference Designs for 169 MHz Antennas</i>	37
<b>8 ADDITIONAL ANTENNA RESOURCES</b>	<b>37</b>
8.1 ANTENNA LITERATURE	37
8.2 EM SIMULATION TOOLS	37
8.3 SMITH CHARTS – ANTENNA MATCHING	38
8.4 GERBER VIEWERS	38
8.5 E2E COMMUNITY	38
8.6 ANTENNA SUPPLIERS AND CONSULTANTS	38
<b>9 SUMMARY</b>	<b>39</b>
<b>10 REFERENCES</b>	<b>42</b>
<b>11 GENERAL INFORMATION</b>	<b>44</b>
11.1 DOCUMENT HISTORY	44

# *Application Note AN058*

## **2 Abbreviations**

AN	Application Note
AUT	Antenna Under Test
BOM	Bill Of Materials
BW	Bandwidth
CTIA	Cellular Telecommunications Industry Association
CW	Carrier Wave
DB	Demonstration Board
DK	Development Kit
DN	Design Note
DUT	Device Under Test
EB	Evaluation Board
EIRP	Effective Isotropic Radiated Power
EM	Electro Magnetic
EM	Evaluation Module
IFA	Inverted-F Antenna
IP	Intellectual Property
ISM	Industrial, Scientific, Medical
LOS	Line of Sight
MIFA	Meandered Inverted-F Antenna
NC	Not Connected
NHPRP	Near Horizon Partial Radiated Power
NHPRP45	Near Horizon Partial Radiated Power within 45 degrees angle
OTA	Over The Air
PCB	Printed Circuit Board
RF	Radio Frequency
RL	Return Loss
SRD	Short Range Device
SWR	Standing Wave Ratio
TI	Texas Instruments
TRP	Total Radiated Power
TTM	Time To Market
VSWR	Voltage Standing Wave Ratio
YAGI	Directional Antenna

## 3 Brief Antenna Theory

The antenna is a key component for reaching the maximum distance in a wireless communication system. The purpose of an antenna is to transform electrical signals into RF electromagnetic waves, propagating into free space (transmit mode) and to transform RF electromagnetic waves into electrical signals (receive mode).

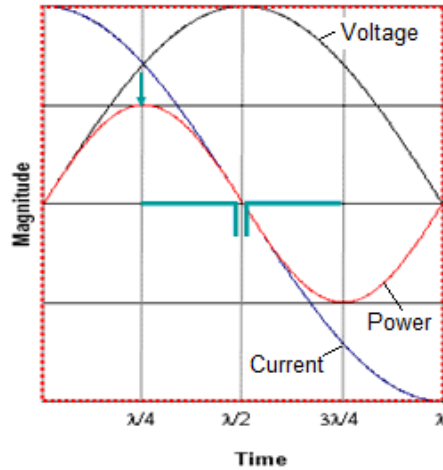

Figure 2. Maximum Power Delivered at Quarter Wavelength

A typical antenna is basically an air core inductor of defined wavelength. As can be seen in Figure 2, the AC current through an inductor lags the voltage by 90 degrees so the maximum power is delivered at  $\frac{1}{4}$  wavelength. The  $\frac{\lambda}{2}$  dipole produces most power at the ends of the antenna with little power in the centre of the antenna.

### 3.1 Dipole ( $\lambda/2$ ) Antennas

A dipole antenna most commonly refers to a half-wavelength ( $\lambda/2$ ). Figure 3 shows the typical emission pattern from a dipole antenna. The antenna is standing in the Z plane and radiating energy outwards. The strongest energy is radiated outward in the XY plane, perpendicular to the antenna.

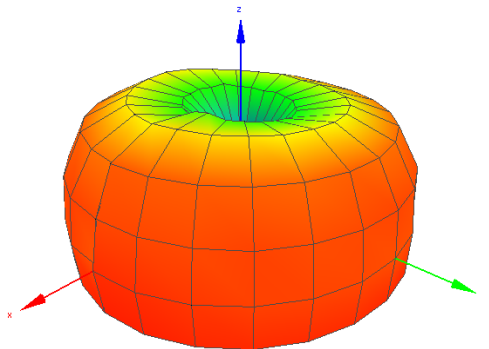

Figure 3. Emission Pattern of a Dipole Antenna

Given these antenna patterns, you can see that a dipole antenna should be mounted so that it is vertically oriented with respect to the floor. This results in the maximum amount of energy radiating out into the intended coverage area. The null in the middle of the pattern will point up and down.

## 3.2 Monopole ( $\lambda/4$ ) Antennas

A monopole antenna most commonly refers to a quarter-wavelength ( $\lambda/4$ ). The antenna is constructed of conductive elements whose combined length is about quarter the wavelength at its intended frequency of operation. This is very popular due to its size since one antenna element is one  $\lambda/4$  wavelength and the GND plane acts as the other  $\lambda/4$  wavelength which produces an effective  $\lambda/2$  antenna. Therefore, for monopole antenna designs the performance of the antenna is dependent on the ground size, refer to Figure 4. All small antennas are derivatives of a simple dipole where one element is folded into the GND and serves as the second radiator.

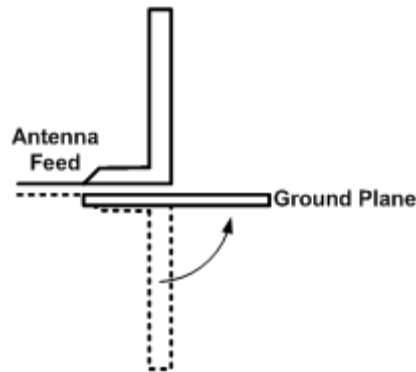

Figure 4. Monopole Antenna Utilizing GND Plane as an Effective  $\lambda/4$  Antenna Element

## 3.3 Wavelength Calculations for Dipole in Free Space

For the same output power, sensitivity and antenna gain; reducing the frequency by a factor of two doubles the range (line of sight). Lowering the operating frequency also means that the antenna increases in size. When choosing the operating frequency for a radio design, the available board space must also accommodate the antenna. So the choice of antenna, and size available should be considered at an early stage in the design.

$$\lambda \text{ meters} = \frac{2.99792458E8 \text{ m/sec}}{f \text{ (GHz)}}$$

Equation 1. Wavelength Equation

Frequency	$\lambda / 4$ (cm)	$\lambda / 4$ (inch)	$\lambda$ (cm)	$\lambda$ (inch)
2.4 GHz	3.1	1.2	12.5	4.9
955 MHz	7.8	3.1	31.4	12.4
915 MHz	8.2	3.2	32.8	12.9
868 MHz	8.6	3.4	34.5	13.6
433 MHz	17.3	6.8	69.2	27.3
169 MHz	44.3	17.5	177.4	69.8
27 MHz	277.6	109.3	1110.3	437.1

Table 1. Various Wavelengths for Several Frequency Ranges

## 3.4 Maximum Power Transfer (VSWR)

Moritz Von Jacobi's maximum power theory states that *maximum* power transfer happens when the source resistance equals the load resistance. For complex impedances, the maximum power delivered from a transmission line with impedance  $Z_0$  to an antenna with impedance  $Z_a$ , it is important that  $Z_0$  is properly matched to  $Z_a$ . If a signal with amplitude  $V_{IN}$  is sent in to the transmission line, only a part of the incident wave will be transmitted to the antenna if  $Z_0$  is not properly matched to  $Z_a$ , refer to Equation 2.

$$Z_0 = Z_a'$$

**Equation 2. Maximum Power Transfer Theorem**

The complex reflection coefficient ( $\Gamma$ ) is defined as the ratio of the reflected waves' amplitude to the amplitude of the incident wave.  $\Gamma$  can be calculated from the impedance of the transmission line and the impedance of the antenna, as shown in Equation 3.

$$\Gamma = \frac{Z_a - Z_0}{Z_a + Z_0}$$

**Equation 3. Complex Reflection Coefficient ( $\Gamma$ )**

The reflection coefficient is zero if the transmission line impedance is the complex conjugate of the antenna impedance. Thus if  $Z_0 = Z_a'$  the antenna is perfectly matched to the transmission line and all the applied power is delivered to the antenna.

Antenna matching typically uses both the Return Loss and the Voltage Standing Wave Ratio (VSWR) terminology. VSWR is the ratio of the maximum output (Input +  $\Gamma$ ) to the minimum waveform (Input -  $\Gamma$ ), refer to Equation 4.

$$VSWR = \frac{V_{max}}{V_{min}} = \frac{V_{input} + V_{reflected}}{V_{input} - V_{reflected}} \quad VSWR = \frac{1 + |\Gamma|}{1 - |\Gamma|}$$

**Equation 4. Voltage Standing Wave Ratio**

The power ratio of the reflected to the incident wave is called Return Loss; this indicates how many decibels the reflected wave power is below the incident wave. Refer to Equation 5.

$$S_{11,dB} = 20 \log(\Gamma) = 20 \log\left(\frac{VSWR - 1}{VSWR + 1}\right)$$

**Equation 5. Return Loss (dB)**

With antenna design, VSWR and Return Loss are a measure of how well the antenna is matched. Refer to Table 2, for the conversions between Return Loss, VSWR and percentage of power loss.

# Application Note AN058

When matching an antenna a VSWR of 1.5 (RL = 14 dB) is a good match, when the VSWR is > 2.0 (RL = 9.5 dB) then the matching network should be reviewed. VSWR of 2.0 (RL = 9.5 dB) is usually used as the acceptable match level to determine the bandwidth of the antenna.

Mismatching of the antenna is one of the largest factors that reduce the total RF link budget. To avoid unnecessary mismatch losses, it is recommended to add a pi-matching network so that the antenna can always be matched. If the antenna design is adequately matched then it just takes one zero ohm resistor or DC block cap to be inserted into the pi-matching network.

VSWR	Return Loss (dB)	% Power / Voltage Loss	Reflection Coefficient	Mismatch Loss (dB)
1	∞	0 / 0	0	0.000
1.15	23.1	0.49 / 7.0	0.07	.021
1.25	19.1	1.2 / 11.1	0.111	.054
1.5	14.0	4.0 / 20.0	0.200	.177
1.75	11.3	7.4 / 27.3	0.273	.336
1.9	10.0	9.6 / 31.6	0.316	.458
2.0	9.5	11.1 / 33.3	0.333	.512
2.5	7.4	18.2 / 42.9	0.429	.880
3.0	6.0	25.1 / 50.0	0.500	1.25
3.5	5.1	30.9 / 55.5	0.555	1.6
4.0	4.4	36.3 / 60.0	0.600	1.94
4.5	3.9	40.7 / 63.6	0.636	2.25
5.0	3.5	44.7 / 66.6	0.666	2.55
10	1.7	67.6 / 81.8	0.818	4.81
20	0.87	81.9 / 90.5	0.905	7.4
100	0.17	96.2 / 98.0	0.980	14.1
∞	.000	100 / 100	1.00	∞

Table 2. VSWR Chart

### 3.5 Antenna Performance Considerations

There are a numerous issues to consider when selecting the antenna:

- Antenna placement
- Ground planes for ¼ wavelength antennas
- Undesired magnetic fields on PCB
- Antenna mismatch (VSWR)
- Objects that alter or disrupt Line of Sight (LOS)
- Antenna gain characteristics
- Antenna bandwidth
- Antenna Radiation Efficiency

### 3.6 Friis Transmission Equation

Friis equation is the primary math model to predicting Line of Sight communication links. This is a very elementary equation and has been expanded to include height of antenna above ground and difference in TX and RX antennas. The formula is very accurate once all the constants have been entered. Please refer to [28] for further information concerning “Range Measurements in an Open Field Environment”.

$$P_r = P_t G_t G_r \left( \frac{\lambda}{4\pi R} \right)^2$$

Equation 6. Friis Transmission Equation

# Application Note AN058

- $\lambda$  = Wavelength in Meters
- $P_r$  = Received Power in dBm
- $P_t$  = Transmit Power in dBm
- $G_t$  = Transmit Antenna Gain in dBi
- $G_r$  = Receive Antenna Gain in dBi
- R = Distance between Antennas in Meters

## 4 Antenna Types

There are several antenna types to choose from when deciding what kind of antenna to use in an RF product. Size, cost and performance are the most important factors when choosing an antenna. The three most commonly used antenna types for short range devices are PCB antennas, chip antennas and wire antennas. Table 3 shows the pros and cons for several antenna types.

Antenna types	Pros	Cons
<b>PCB antenna</b>	<ul style="list-style-type: none"><li>• Very low cost</li><li>• Good performance at &gt; 868 MHz</li><li>• Small size at high frequencies</li><li>• Standard design antennas widely available</li></ul>	<ul style="list-style-type: none"><li>• Difficult to design small and efficient PCB antennas at &lt; 433 MHz</li><li>• Potentially large size at low frequencies</li></ul>
<b>Chip antenna</b>	<ul style="list-style-type: none"><li>• Small size</li><li>• Short TTM since purchasing antenna solution</li></ul>	<ul style="list-style-type: none"><li>• Medium performance</li><li>• Medium cost</li></ul>
<b>Whip antenna</b>	<ul style="list-style-type: none"><li>• Good performance</li><li>• Short TTM since purchasing antenna solution</li></ul>	<ul style="list-style-type: none"><li>• High cost</li><li>• Difficult to fit in many applications</li></ul>
<b>Wire antenna</b>	<ul style="list-style-type: none"><li>• Very cheap</li></ul>	<ul style="list-style-type: none"><li>• Mechanical manufacturing of antenna</li></ul>
<b>IP based antenna</b>	<ul style="list-style-type: none"><li>• Support from IP company</li></ul>	<ul style="list-style-type: none"><li>• High cost compared to standard free PCB antenna designs.</li><li>• Similar cost to Chip antenna</li></ul>

**Table 3. Pros and Cons for Different Antenna Solutions**

It is also common to divide antennas into single ended antennas and differential antennas. Single ended antennas are also called unbalanced antennas, while differential antennas are often called balanced antennas. Single ended antennas are fed by a signal which is referenced to ground and the characteristic input impedance for these antennas is usually 50 ohms. Most RF measurement equipments are also referenced to 50 ohms. Therefore, it is easy to measure the characteristic of a 50 ohm antenna with such equipment.

However many RF IC's have differential RF ports and a transformation network is required to use a single ended antenna with these IC's. Such a network is called a balun since it transforms the signal from balanced to unbalanced configuration. Figure 5 shows a single ended antenna and a differential antenna.



# Application Note AN058

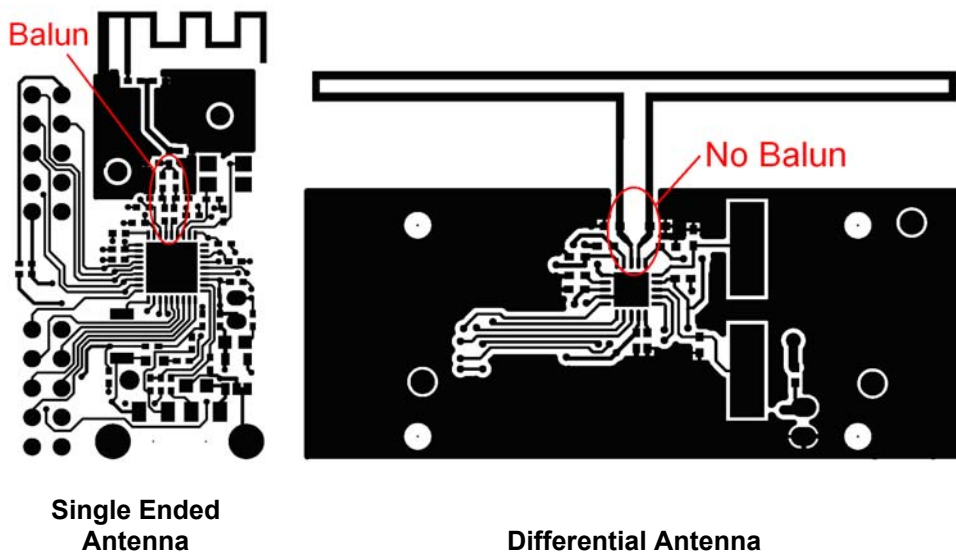

**Figure 5. Single Ended and Differential Antenna**

The antennas presented in this document are for the license free world wide band 2.4000 GHz - 2.4835 GHz band and the all the standard frequency bands at sub 1 GHz. For the sub 1 GHz bands; there is usually a “low” sub 1 GHz band and a “high” sub 1 GHz band.

The “high” sub 1 GHz band in Europe covers 863-870 MHz, the US covers 902-928 MHz band and the Japanese band 955 MHz. The European band is usually referred to as the “868 MHz band” and the US band is commonly designated the “915 MHz band”. It is often possible to achieve good performance with the same antenna for both the European 868 MHz, US 915 MHz and Japanese 955 MHz bands by tuning the antenna length or changing the values of the matching components. Such antennas are called “868/915/955” MHz antennas” in this document.

The “low” sub 1 GHz band in Europe covers 433.050 - 434.790 MHz, the US covers 300-348 MHz band. The European band is usually referred to as the “433 MHz band” and the US band is commonly designated the “315 MHz band”.

## 4.1 PCB Antennas

Our ambition is to provide excellent antenna reference designs and application notes so the design-in process will be easier and quicker. With RF designs, the antenna design is a critical stage to be able to achieve the best possible link budget for a specific application. As previously mentioned in 3.5, there are many considerations when choosing the type of antenna.

The antenna application notes are updated on a regular basis with new designs. The TI antenna designs that are released are free of charge and can be used directly in the final application design. In addition to these free TI antenna designs, we also have specific antennas designs that are IP based. The antenna IP company usually has a specific design profile such as directivity or compact design for example.

The antenna in the basic form, PIFA, patch, spiral etc is generally free from patent infringement because these are well known designs that have been around for many years. When the antenna is adapted from the "standard format"; then the antennas are more than likely protected through patents. It is important to keep this in mind when developing a new antenna. Many antenna patents collide with each other and which company had the original IP, and if the IP is valid can be a long discussion. It is advisable to keep the standard text book antenna designs when developing an antenna to avoid any legal discussions.

### 4.1.1 TI Antenna Reference Designs

Designing a PCB antenna is not straight forward and usually a simulation tool must be used to obtain an acceptable solution. In addition to deriving an optimum design, configuring such a tool to perform accurate simulations can also be difficult and time consuming. It is therefore recommended to make an exact copy of one of the reference designs available at [www.ti.com/lpw](http://www.ti.com/lpw), if the available board space permits such a solution. See section 7 for a description of the available reference designs.

The CC-Antenna-DK [43] contains 13 low cost antennas and 3 calibration boards. The antennas cover the frequency range as low as 136 MHz to 2.48GHz; refer to Figure 1. The antenna designs from the CC-Antenna-DK are summarized in 7.1.

If the application requires a special type of antenna and none of the available reference designs fits the application, it could be advantageous to contact an antenna consultant or look for other commercially available solutions. Table 8 lists a few companies that can offer such services.

### 4.1.2 IP Based

There are many IP antenna design companies that sell their antenna design competence through IP. Since there is no silicon or firmware involved; the only way for the antenna IP companies to protect their antenna design is through patents. Purchasing a chip antenna or purchasing an IP for the antenna design is similar since there is an external cost for the antenna design.

IP based antennas from Pinyon are specifically designed for directional operation (5.2) and Fractus is targeting compact designs as well as sales of their standard chip antennas.

An alternative to the IP Pinyon antenna reference designs [20], [21], [22] & [23] can be a standard patch antenna or YAGI antenna (refer to Section 7.2.3) which will also give directivity but with no IP cost attached. A 2.4 GHz patch antenna will be released as a reference design. The patch antenna mainly radiates in just one direction (one main lobe) whereas the IP Pinyon antenna has two lobes, similar to a figure eight. The YAGI antenna usually has a higher gain than the patch antenna and is typically larger in size as well.

## **4.2 Chip Antennas**

If the available board space for the antenna is limited a chip antenna could be a good solution. This antenna type allows for small size solutions even for frequencies below 1 GHz. The trade off compared to PCB antennas is that this solution will add BOM and mounting cost. The typical cost of a chip antenna is between \$0.10 and \$0.50. Even if manufacturers of chip antennas state that the antenna is matched to 50 ohms for a certain frequency band, it is often required to use additional matching components to obtain optimum performance. The performance numbers and recommended matching given in data sheets are often based on measurements done with a test board. The dimensions of this test board are usually documented in the data sheet. It is important to be aware that the performance and required matching will change if the chip antenna is implemented on a PCB with different size and shape of the ground plane.

## **4.3 Whip Antennas**

If good performance is the most important factor, size and cost are not critical; an external antenna with a connector could be a good solution. If a connector is used then to pass the regulations, conducted emission tests must also be performed. The whip antenna should be mounted normally on the ground plane to obtain best performance. Whip antennas are typically more expensive than chip antennas, and will also require a connector on the board that also increases the cost. Notice that in some cases special types of connectors must be used to comply with SRD regulations. For more information about SRD regulations please refer to [1] and [2].

## **4.4 Wire Antennas**

For applications that operate in the lower bands of the sub 1 GHz such as 315 MHz and 433 MHz; the antenna is quite large, refer to Table 1. Even when the earth plane is utilized for half of the antenna design; the overall size can be large and difficult to put onto a PCB. What can be done for this frequency range which is practical and cheap; a wire can be used for the antenna and the wire can be formed around the mechanical housing of the application.

The pros of such a solution are the price and good performance can be obtained. The cons are the variations of the positioning of the antenna in the mechanical housing will have to be controlled so that the antenna will not vary too much during volume production.

A standard cable can be used as an antenna if cut to the right length, refer to Table 1. The performance and radiation pattern will change depending on the position of the cable. If this type of antenna is used then it is good practice to keep the first part of the cable which is closest to the feed point into a more controlled position so the matching will not be affected too much when the remaining cable antenna changes positions when touched or moved.

## 5 Antenna Parameters

There are several parameters that should be considered when choosing an antenna for a wireless device. Some of the most important things to consider are how the radiation varies in the different directions around the antenna, how efficient the antenna is, the bandwidth which the antenna has the desired performance and the antenna matching for maximum power transfer. Sections 5.1 and Section 6.3 give an explanation on how these properties are defined and how they should be evaluated. Since all antennas require some space on the PCB, the choice of antenna is often a trade off between cost, size and performance.

### 5.1 Radiation Patterns

Antenna specs from the majority of suppliers will reference their designs to an ideal Isotropic antenna. This is a model where the antenna is in a perfect sphere and isolated from all external influences. Most of the measurements of power are done in units of dBi where “i” refers to the condition of isotropic antenna. Power measurements for a theoretical isotropic antenna are in dBi. Dipole Antenna Power is related to an isotropic antenna by the relationship  $0 \text{ dBd} = 2.14 \text{ dBi}$ .

The radiation pattern is the graphical representation of the radiation properties of the antenna as a function of space. i.e. the antenna's pattern describes how the antenna radiates energy out into space (or how it receives energy). It is common, however, to describe this 3D pattern with two planar patterns, called the principal plane patterns. These principal plane patterns can be obtained by making two slices through the 3D pattern through the maximum value of the pattern or by direct measurement. It is these principal plane patterns that are commonly referred to as the antenna patterns.

Principal plane patterns or even antenna patterns, you will frequently encounter the terms azimuth plane pattern and elevation plane pattern. The term azimuth is commonly found in reference to the horizontal whereas the term elevation commonly refers to "the vertical". When used to describe antenna patterns, these terms assume that the antenna is mounted (or measured) in the orientation in which it will be used.

The azimuth plane pattern is measured when the measurement is made traversing the entire XY plane around the antenna under test. The elevation plane is then a plane orthogonal to the XY plane, say the YZ plane ( $\phi = 90 \text{ deg}$ ). The elevation plane pattern is made traversing the entire y-z plane around the antenna under test.  $\theta$  is associated with elevation plane and  $\phi$  with azimuth plane. The antenna patterns (azimuth and elevation plane patterns) are frequently shown as plots in polar coordinates.

The azimuth plane pattern is formed by slicing through the 3D pattern in the horizontal plane, the XY plane in this case. Notice that the azimuth plane pattern is directional, the antenna does not radiate its energy equally in all directions in the azimuth plane.

The elevation plane pattern is formed by slicing the 3D pattern through an orthogonal plane (either the XZ plane or the YZ plane).

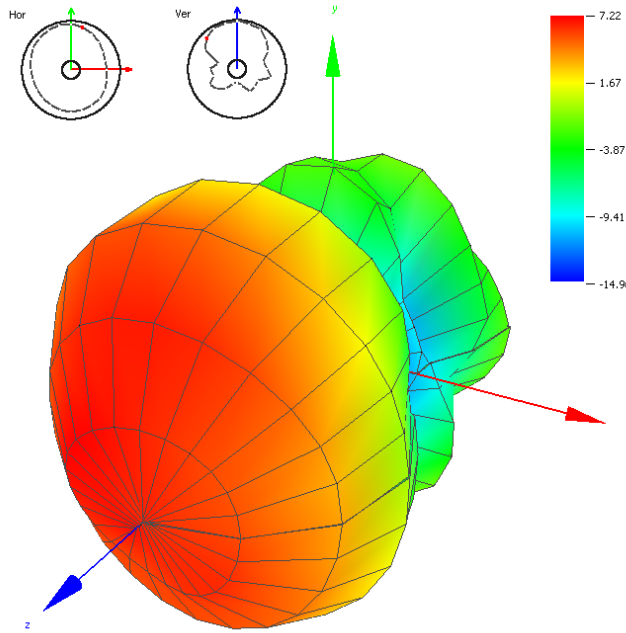

**Figure 6. 3D Radiation Pattern from a YAGI Directional Antenna**

It is also important to be able to relate the different directions on the radiation pattern plot to the antenna. With the 3D plots; the XYZ coordinates are usually documented with a picture of the AUT; this is required since the orientation of the AUT in the anechoic chamber usually changes depending on the physical size and the possibility to position the AUT on the turn arm. This can be seen in Figure 7 which is board 6 from the CC-Antenna-DK.

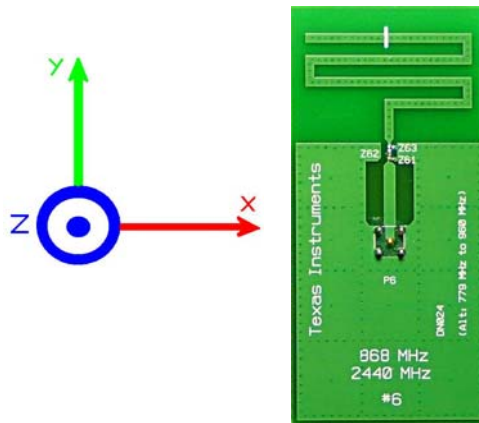

**Figure 7. 3D Coordinates AUT Example**

Prior to the availability of 3D radiation patterns, the AUT was typically measured in three orthogonal planes, XY, XZ and YZ. Another way of defining these three planes is by using a spherical coordinate system. The planes will then typically be defined by  $\theta = 90^\circ$ ,  $\phi = 0^\circ$  and  $\phi = 90^\circ$ . Figure 8 shows how to relate the spherical notation to the three planes. If no information is given on how to relate the directions on the radiation pattern plot to the positioning of the antenna,  $0^\circ$  is the X direction and angles increase towards Y for the XY plane. For the XZ plane,  $0^\circ$  is in the Z direction and angles increase towards X, and for the y-z plane,  $0^\circ$  is in the Z direction and angles increase towards Y.

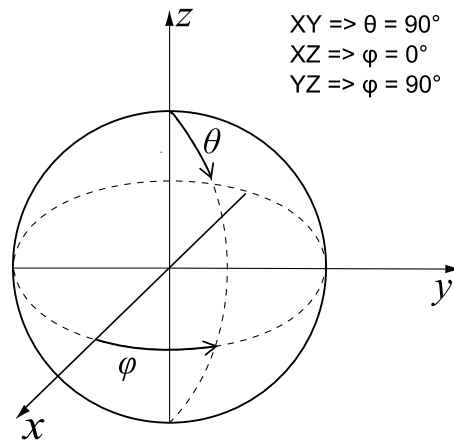
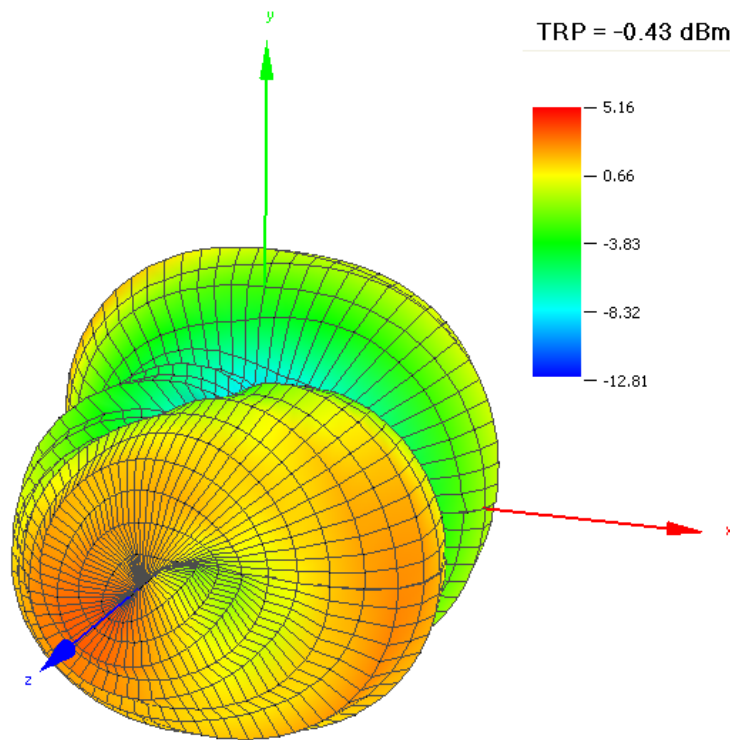

**Figure 8. Traditional Spherical Coordinate System for Radiation Patterns**

A dipole antenna radiates its energy out toward the horizon (perpendicular to the antenna). The resulting 3D pattern looks like a donut with the antenna sitting in the hole and radiating energy outward. The strongest energy is radiated outward, perpendicular to the antenna in the XY plane. Given these antenna patterns, you can see that a dipole antenna should be mounted so that it is vertically oriented with respect to the floor or ground. This results in the maximum amount of energy radiating out into the intended coverage area. The null in the middle of the pattern will point up and down.

Figure 9 shows how the radiation from the PCB antenna shown in Figure 7 varies in different directions. Several parameters are important to know when interpreting such a plot. Some of these parameters are stated in the top right portion of Figure 9.

With the AUT coordinate description in Figure 7 and the measured radiated pattern in Figure 9, the radiation pattern can be related to the AUT. The peak signal strengths can be observed and taken into account when radiated power from a given angle. This is useful information for the positioning of the AUT when performing range tests, calculating link budgets and determining the expected range.



**Figure 9. Radiation Pattern from board 6 (868 MHz) from the CC-Antenna-DK**

The gain or the reference level is usually referred to an isotropic radiating antenna which is an ideal antenna that has the same level of radiation in all directions. When such an antenna is used as a reference, the gain is given in dBi or specified as the Effective Isotropic Radiated Power (EIRP) [6.3].

The Transmitted Radiated Power (TRP) is shown in Figure 9 as -0.43 dBm. Standard CTIA OTA reports usually nominate the TRP with respect to an input of 0 dBm. The colour scale notation in the top right of Figure 9 illustrates the specific span of the TRP. A peak gain of 5.16 dB has been recorded with the lowest level at -12.81dB. This means that compared to an isotropic antenna the PCB antenna in Figure 7 will have 5.16 dB higher radiated power in the direction where the TRP was recorded at 5.16dB; this looks like this is in the “Z” direction according to Figure 9.

### 5.1.1 Polarization

Polarization describes the direction of the electric field. All electromagnetic waves propagating in free space have electric and magnetic fields perpendicular to the direction of propagation. Usually, when considering polarization, the electric field vector is described and the magnetic field is ignored since it is perpendicular to the electric field and proportional to it. The receiving and transmitting antenna should have the same polarization to obtain optimum performance. Most antennas in SRD application will in practice produce a field with polarization in more than one direction. In addition reflections will change the polarization of an electric field. Polarization is therefore not as critical for indoor equipment, which experiences lots of reflections, as for equipment operating outside with Line of Sight (LOS). Some antennas produce an electrical field with a determined direction, it is therefore also important to know what kind of polarization that was used when measuring the radiation pattern. It is also important to state which frequency the measurement was done at. Generally the radiation pattern does not change rapidly across frequency. Thus it is usual to measure the radiation pattern in the middle of the frequency band in which the antenna is going to be used. For narrowband antennas the relative level could change slightly within the desired frequency band, but the shape of the radiation pattern would remain basically the same.



# Application Note AN058

## 5.1.2 Ground Effects

The size and shape of the ground plane will affect the radiation pattern. Figure 10 shows an example of how the ground plane affects the radiation pattern. The radiation pattern in the upper left corner is measured with the small antenna board plugged in to the SmartRF04EB, while the pattern in the upper right corner of Figure 10 is measured with the antenna board used as stand alone board. SmartRF04EB has a solid ground plane. By plugging the antenna board into this, the effective ground plane seen by the antenna is increased; this effects the antenna match and also the SmartRF04EB ground plane restricts emissions compared to using the antenna board as stand alone. The change in size and shape of the ground plane not only changes the gain but the radiation pattern. Since many SRD applications are mobile, it is not always the peak gain that is most interesting. The TRP and antenna efficiency gives a better indication on power level that is transmitted from the AUT.

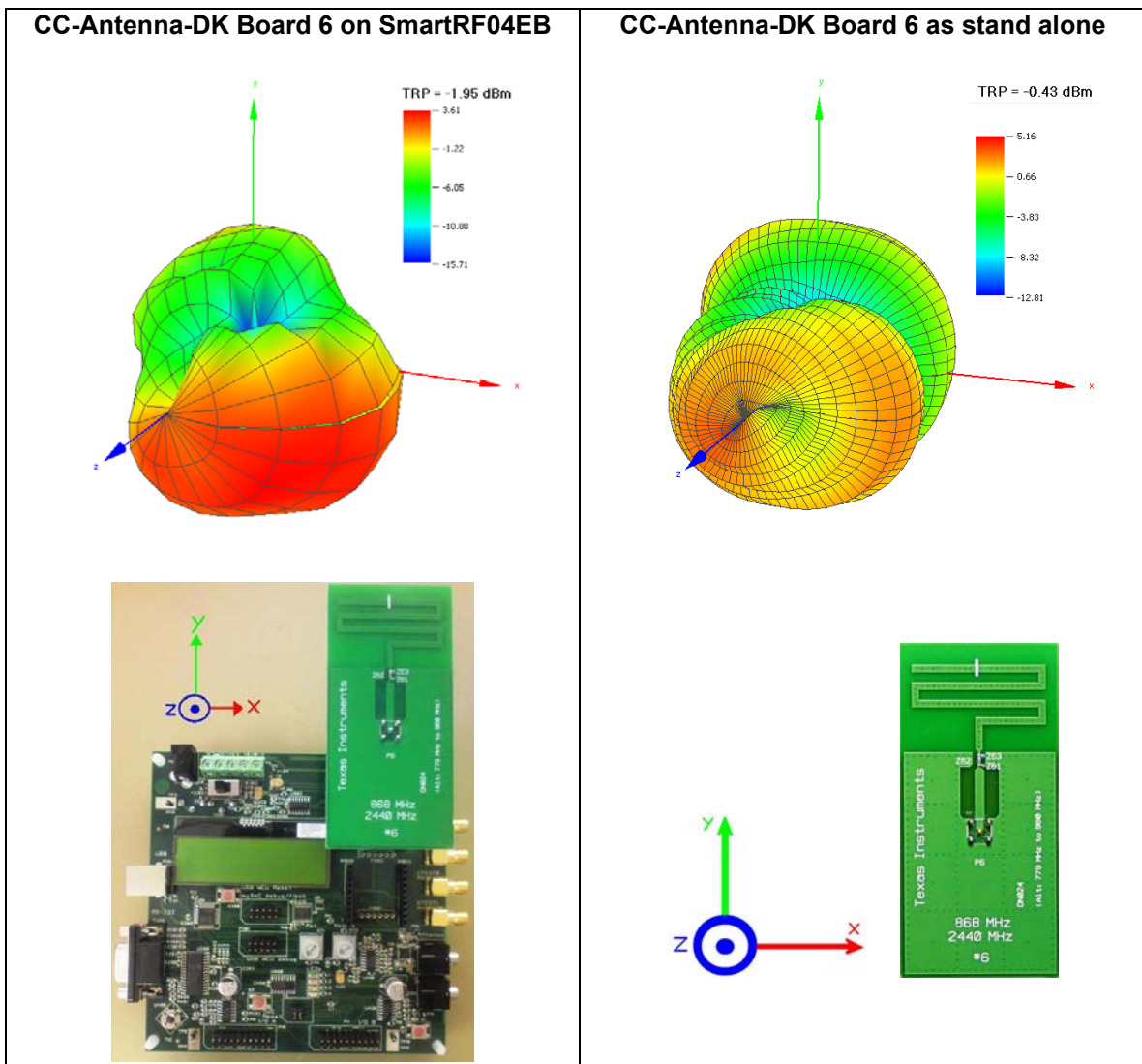

Figure 10. Influence on Shape and Size of the Ground Plane on Radiation Pattern



## 5.2 Directional Antennas

High gain does not automatically mean that the antenna has good performance. Typically for a system with mobile units it is desirable to have an omni-directional radiation pattern such that the performance will be approximately the same regardless of which direction the units are pointed relative to each other.

Applications environments such as corridor coverage, metering surveillance, and maximum range distance between two fixed devices can be ideal applications for the directional type of antennas. One advantage of using a directional antenna is the PA power can be reduced due to the higher gain in the antenna between two devices for a given distance so that current consumption can be reduced. Another advantage is that the antenna gain can be utilized to achieve a greater range distance between two devices.

However, a disadvantage of using directional antennas is that the **positioning of the transmitter and receiver unit must be known in detail**. If this information is not known then it is best to use a standard omni-directional antenna design such as described in DN007 [4].

## 5.3 Size, Cost and Performance

The ideal antenna is infinitely small, has zero cost and has excellent performance. In real life this is not possible. Therefore a compromise between these parameters needs to be found. By reducing the operating frequency by a factor of two, the effective range is doubled. Thus one of the reasons for choosing to operate at a low frequency when designing an RF application is often the need for long range. However, most antennas need to be larger at low frequencies in order to achieve good performance, Table 1.

In some cases where the available board space is limited, a small and efficient high frequency antenna could give the same or better range than a small and inefficient low frequency antenna. A chip antenna is a good alternative when seeking a small antenna solution. Especially for frequencies below 433 MHz, a chip antenna will give a much smaller solution compared to a traditional PCB antenna. The main drawbacks with chip antennas are the increased cost and often narrow band performance.

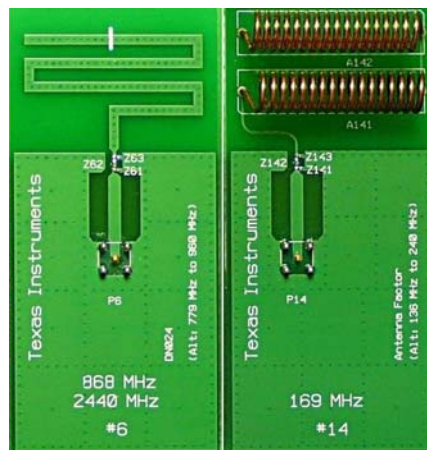

**Figure 11. Size v Performance Example using Boards 6 & 14 from CC-Antenna-Kit**

Figure 11 shows the layout of board 6 (868 MHz) and board 14 (169 MHz) from the CC-Antenna-Kit [29]. Both board size and area allocated for the antenna are identical for these two boards. Board 6 has been tuned for 868 MHz and Board 14 tuned for 169 MHz. The antenna efficiency of board 6 was recorded at 91% efficiency; board 14 antenna efficiency is very low at 7%. For the efficiency of the board 14, 169 MHz antenna to be increased; the antenna and GND size has to be physically increased. By using the meandering layout techniques on the PCB antenna, the total size can be reduced, refer to Table 1.

## 6 Antenna Measurements

### 6.1 Measuring Bandwidth with a Spectrum Analyzer

Using a spectrum analyzer, the bandwidth of the antenna can be observed by measuring the radiated power when stepping a carrier across the frequency band of interest. This can be easily done with the SmartRF Studio version 7, refer to Figure 12 for the screen dump of SmartRF Studio whilst performing a frequency sweep on CC1110.

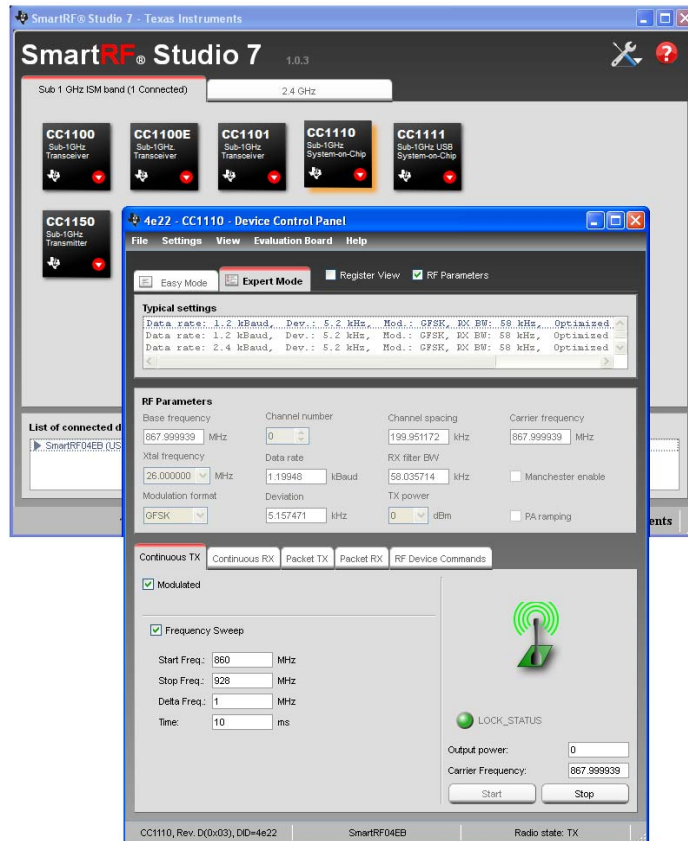

Figure 12. Using SmartRF Studio to Perform a Frequency Sweep

The screen shot of the spectrum analyzer can be seen in Figure 13 whilst frequency sweeping to determine the bandwidth for a 2.4 GHz radio. For the 2.4 GHz frequency sweep measurement, a 2.4 GHz antenna must be connected to the spectrum analyzer so the radiated power can be measured from the AUT. The results show that the antenna has approximately 2 dB variation in output power across the 2.4 GHz frequency band and max radiation at the centre of this band.

Such measurements should ideally be performed in an anechoic chamber to obtain a correct absolute level. This kind of measurement can however also be very useful even if an anechoic chamber is not available. Performing such a measurement in an ordinary lab environment will give a relative result, which shows whether the antenna has optimum performance in the middle of the desired frequency band. The performance of the antenna connected to the spectrum analyzer will affect the result. Thus it is important that this antenna has approximately the same performance across the frequency band being used. This will ensure that the result gives a correct view of the relative change in performance across the measured frequency band.

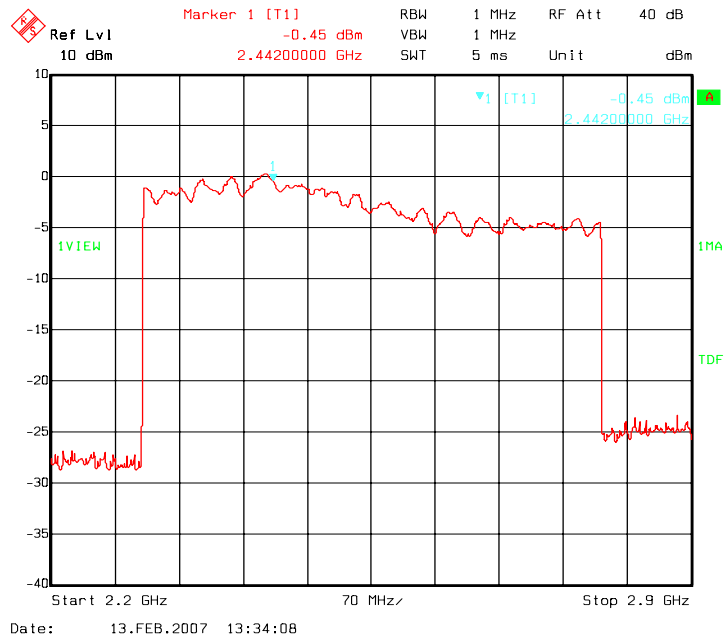

Figure 13. Bandwidth of a 2.4 GHz Antenna.

## 6.2 Measuring RL, Impedance and Bandwidth with a Network Analyzer

The optimum method to characterize the antenna is to use a Network Analyzer so the Return Loss, Impedance and Bandwidth can be determined. This is done by disconnecting the antenna from the radio section and connecting a semi-rigid coax cable at the feed point of the antenna.

### 6.2.1 Mounting of cable for S11 measurements

It is invaluable to have semi-rigid cables in the lab for debugging RF. Solder first shielding onto an earth plane and then solder the 50 ohm connection. Minimize risk for ripping off tracks when connecting to the semi-rigid cable. Ready made semi-rigid cables are quite expensive but can be re-used again. A semi rigid coax cable is useful when performing measurements on prototypes. The outer of the cable should be soldered to ground while the inner conductor is soldered to the feed line of the antenna. It is important that the antenna is disconnected from the rest of the circuitry when this measurement is performed. The unshielded part of the inner conductor should be as short as possible to avoid introducing extra inductance when measuring and the outer should be soldered to ground as close as possible to the end of the cable. To avoid that the presence of the cable is affecting the result, the cable should be placed as far away from the antennas as possible

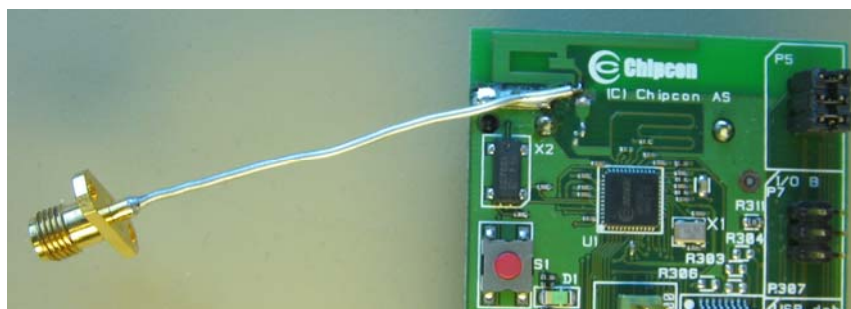

Figure 14. Mounting of Semi-Rigid Cable to Measure Antenna Characteristics

## 6.2.2 Calibration

It is important to calibrate the network analyzer before doing measurements. The network analyzer should be calibrated for a suitable frequency range containing the band where the antenna will operate. Typically network analyzers have a cable with SMA connector in the end. Calibration is performed by connecting three known terminations, 50 ohm load, short, and open, to this SMA connector. After calibration the reference plane will be at the connection point of the SMA connector. To measure the reflection at the feed point of the antenna, a semi rigid coax cable with SMA connector in one end, can be used. This cable is soldered to the feed point of the antenna and the connector is connected to the network analyzer. Return Loss is only dependent of the absolute value of the reflection coefficient and hence there is no need to move the reference plane to the feed point to make a correct measurement.

To measure the impedance of the antenna it is necessary to move the reference plane from the SMA connector to the feed point of the antenna. This must be done to adjust for the phase change caused by the semi rigid coax cable. On most network analyzers it is possible to choose an electrical delay to compensate for this phase change. The correct delay can be found by watching how the impedance varies, in the Smith Chart, when measuring the impedance with an open and shortened end of the coax cable.

With the end of the coax cable short circuited, the electrically delay should be varied until the impedance is seen as a point to the left in the Smith Chart. Theoretically the same electric delay should result in a point to the right in the Smith Chart when the end is left open. If there is a small difference between the optimum electric delay for the opened and short circuited case, the averaged value should be chosen. When the correct electric delay is found, a correct measurement of the impedance can be performed.

It is ideal to have dedicated boards that are specifically used just for calibration purposes. In the CC-Antenna-DK, there are three boards dedicated for calibration purposes, refer to

	CC-Antenna-DK	Using a semi-rigid cable
1. OPEN	Board 9	end connection in air
2. SHORT	Board 1	end connector to closest GND; shield connected to GND
3. LOAD (50ohm)	Board 2	useful to use two 100ohm parallel resistors assembled at the end connection point; shield connected to GND

**Table 4. Calibration with CC-Antenna-DK Boards or Usage of Semi-Rigid Cable**

By performing these steps then the antenna feed track or semi-rigid cable is also taken care of during the calibration. By just using the network analyzer calibration kit; then the semi-rigid cables will be a part of the measurements.

Keep the cables in a constant direction and it is good practice to use cable ties to maintain cables including network analyzer cables in a fixed position. The placement of the cable can affect the measurement result, especially if there are strong currents traveling back and forth on the ground plane.

Ferrites can be used to reduce the influence from currents running at the outer of the cable. PCBs which have a ground plane with dimensions that are a fraction of a wavelength tend to have larger currents running on the ground plane. This could potentially cause more unstable results when trying to measure the reflection at the feed pint of antennas implemented on such PCBs, refer to Figure 15. The placement of the ferrite along the cable will also affect the result. Thus it is important to understand that there is a certain inaccuracy when performing this kind of measurement.

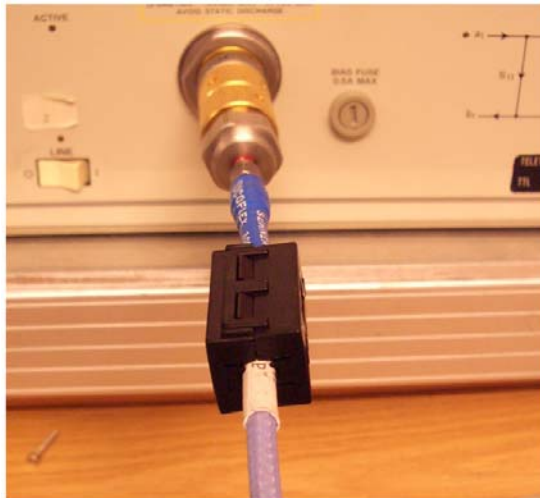

**Figure 15. Usage of Ferrites during Antenna Measurements**

### 6.2.3 Placement of the Device under Test

How the antenna is placed during the measurement will affect the result. Therefore the antenna should be situated in the same manner as it is going to be used when the Return Loss and impedance is measured. To achieve higher accuracy of the measurements, the real performance of an antenna should be placed inside the final casing which is going to be used.

Handheld devices should also be positioned in a hand when conducting the measurement to the real life scenario is being taken into account whilst performing the measurements. Even if the antenna is going to be used in a special environment it could also be useful to measure the antenna in free space. This will show how much body effects, plastic casing and other parameters affect the result. To get an accurate result when measuring the antenna in free space, it is important that the antenna is not placed close to other objects. Some kind of damping material could be used to support the antenna and avoid that it lies directly on a table during measurements.

### 6.2.4 Interpreting Measurement Results

To measure an antenna connected to port 1 on a network analyzer, S11 should be chosen. The measured reflection is usually displayed as S11 in dB or as VSWR [3.4].

Figure 16 shows results from measurements performed on a PCB antenna intended for a handheld device. From these results it can be seen how the performance is affected by the plastic casing and body effects. With  $S_{11} < -10\text{dB}$  as a requirement, this antenna has an approximately bandwidth of 400MHz.

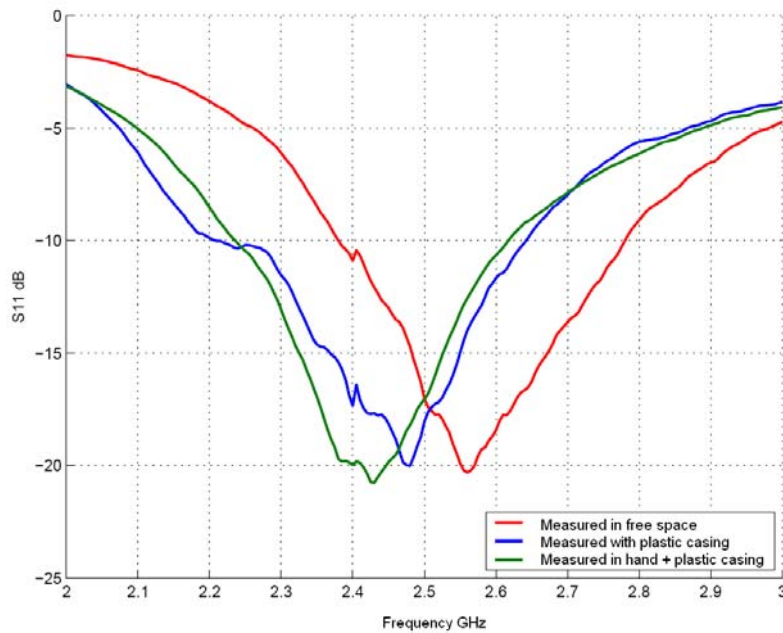

**Figure 16. Measurement of Return Loss**

The impedance can be measured to see what kind of tuning is necessary to improve the performance of the antenna. Figure 17 shows the corresponding impedance measurements for the handheld device PCB antenna presented in Figure 16

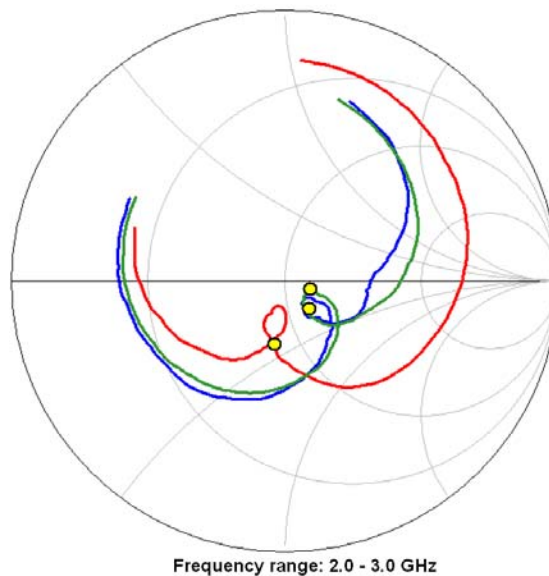

**Figure 17. Measurements of Impedance**

2.44GHz is marked with a yellow dot. The red plot shows the reflection when the antenna is positioned in free space with no objects in its vicinity. Encapsulating the antenna in plastic affects the performance by lowering the resonance frequency. This is shown by the blue graph. By holding the encapsulated antenna in one's hand, the performance is affected even more. This shows why it is important to do characterization and tuning when the antenna is placed in the position and environment it is going to be used during normal operation.



## 6.2.5 Antenna Matching

There are several ways to tune an antenna to achieve better performance. For resonant antennas the main factor is the length. Ideally the frequency which gives least reflection should be in the middle of the frequency band of interest. Thus if the resonance frequency is too low, the antenna should be made shorter. If the resonance frequency is too high, the antenna length should be increased.

Even if the antenna resonates at the correct frequency it might not be well matched to the correct impedance. Dependent of the antenna type there are several possibilities to obtain optimum impedance at the correct frequency. Size of ground plane, distance from antenna to ground plane, dimensions of antenna elements, feed point, and plastic casing are factors that can affect the impedance. Thus by varying these factors it might be possible to improve the impedance match of the antenna. If varying these factors is not possible or if the performance still needs to be improved, discrete components could be used to optimize the impedance. Capacitors and inductors in series or parallel can be used to match the antenna to the desired impedance. Figure 18 shows how inductors and capacitors can be used to change the impedance.

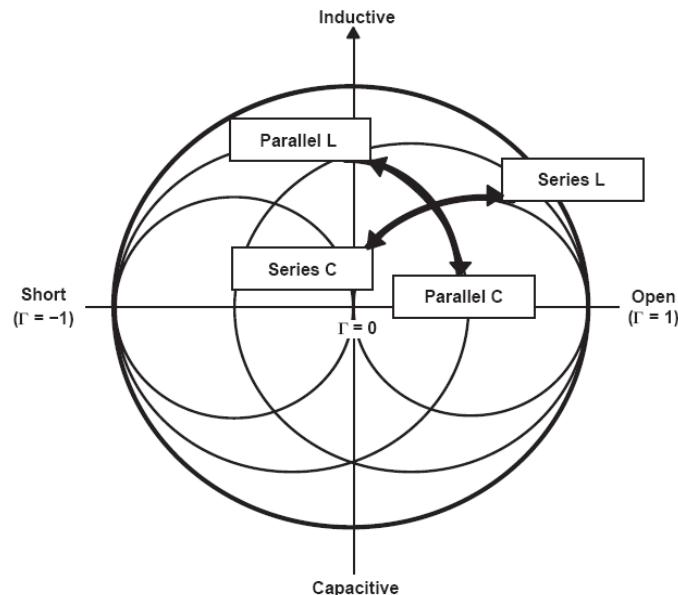

**Figure 18. Series and Parallel Capacitors and Inductors in the Smith Chart**

It is important that tuning of the antenna is being done when the antenna is placed in the environment where it is going to be used. As shown in Figure 16, the environment around the antenna has a great impact of the performance. This means that optimizing the antenna when it is not placed in the correct environment can result in decreased performance.

There are several freeware programs available for matching using Smith charts, see section 8.3.

## 6.3 Over-The-Air (OTA) Measurements

To make an accurate measurement of the radiation pattern, it is important to be able to measure only the direct wave from the AUT and avoid any reflecting waves affecting the result. It is therefore common to perform such measurements in an anechoic chamber. Another requirement is that the measured signal must be a plane wave in the far field of the antenna. The far field distance ( $R_f$ ) is determined by the wavelength ( $\lambda$ ) and the largest dimension ( $D$ ) of the antenna, see Equation 7. Since the size of anechoic chambers is limited, it is common to measure large and low frequency antennas in outdoor ranges.

$$R_f = \frac{2D^2}{\lambda}$$

**Equation 7. Far Field Distance**

OTA testing provides a more accurate testing for wireless devices in order to be able to determine the antenna characteristics of the final product. Traditionally, the antenna radiation patterns were stated as horizontal and vertical polarizations in XY, XZ & YZ planes as shown in Figure 8. This information is still useful, but for the majority of wireless devices, the polarization and positioning is usually unknown and makes comparing antennas difficult.

The testing is performed in an anechoic chamber and the transmitted power is recorded in a dual polarized antenna. The AUT is fixed onto the turn arm which is on the turn table. The turn table rotates from 0 to 180 degrees and the turn arm is rotated 360 degrees so a 3D radiation diagram can illustrate the spatial distributions.

The hardware part of the test system is based on the R&S TS8991 and the software is EMC32. Within the EMC32 program, a standard CTIA OTA report is generated from the test suite that is performed and the main results obtained are:

- Total Radiated Power, TRP (dBm)
- Peak EIRP (dBm)
- Directivity (dBi)
- Efficiency (%)
- Gain (dBi)
- NHPRP

Figure 19 shows the typical format and the parameters specified in the CTIA OTA measurement report. The advantages of having a standard measurement suite are that two antennas can be compared and documented in a easier manner.



## OTA Test Results for Frequency 2440.000 MHz

OTA Evaluation Results:

Total Radiated Power	-0.26 dBm
Peak EIRP	5.89 dBm
Directivity	6.15 dBi
Efficiency	-0.26 dB
Efficiency	94.17 %
Gain	5.89 dBi
NHPRP 45°	-2.07 dBm
NHPRP 45° / TRP	-1.81 dB
NHPRP 45° / TRP	65.90 %
NHPRP 30°	-3.93 dBm
NHPRP 30° / TRP	-3.67 dB
NHPRP 30° / TRP	42.95 %
NHPRP 22.5°	-5.07 dBm
NHPRP 22.5° / TRP	-4.81 dB
NHPRP 22.5° / TRP	33.05 %
UHRP	-3.65 dBm
UHRP / TRP	-3.39 dB
UHRP / TRP	45.81 %
LHRP	-2.92 dBm
LHRP / TRP	-2.66 dB
LHRP / TRP	54.19 %
Front/Back Ratio	16.57
PhiBW	118.1 deg
PhiBW Up	87.9 deg
PhiBW Down	30.2 deg
ThetaBW	32.0 deg
ThetaBW Up	11.1 deg
ThetaBW Down	20.8 deg
Boresight Phi	30 deg
Boresight Theta	150 deg
Maximum Power	5.89 dBm
Minimum Power	-12.15 dBm
Average Power	0.72 dBm
Max/Min Ratio	18.04 dB
Max/Avg Ratio	5.17 dB
Min/Avg Ratio	-12.87 dB
Best Single Value	5.34 dBm
Best Position	Phi = 270 deg; Theta = 180 deg; Pol = Hor

**Figure 19. Standard Format of CTIA OTA Measurement Report**

Total Radiated Power (TRP) is calculated by integrating the power measured for the complete rotation of the AUT.

Effective Isotropic Radiated Power (EIRP) is the amount of power that a theoretical isotropic antenna would emit to produce the peak power density observed in the direction of maximum antenna gain and this stated in dBm.

Gain is usually referred to an isotropic antenna and with the designation dBi. Directivity and Gain are angular dependent functions. Referring to Figure 19, Directivity is the difference from the Peak EIRP and TRP; Gain is the sum of Efficiency and Directivity, refer to Equation 9.

Ohmic losses in the antenna element and reflections at the feed point of the antenna determine the efficiency. It is important to state that the antenna gain is not similar to amplifier gain where there is more power generated. Antenna gain is just a measure of the antenna directivity and an antenna can only radiated the power that is delivered to the antenna.

Efficiency ( $\eta$ ) is the relation between the TRP ( $P_{rad}$ ) and the input power ( $P_{in}$ ) delivered to the AUT, refer to Equation 8. This data is presented in both dB and in percentage. Efficiency can also be expressed with the relation between Gain ( $Gain_{max}$ ) and Directivity ( $D_{max}$ ), refer to Equation 9. Gain takes into account VSWR mismatch and energy losses.

$$\eta = \frac{P_{rad}}{P_{in}} * 100\%$$

**Equation 8. Efficiency Definition with Relation to Power**

$$\text{Gain}_{\text{max}} = \eta D_{\text{max}}$$

## Equation 9. Efficiency Definition with Relation to Gain and Directivity

NHPRP is the Near Horizon Partial Radiated Power that is specified for 45 degrees (NHPRP45), 30 degrees (NHPRP30) and 22.5 degrees (NHPRP22.5) from the horizon.

## 7 Antenna Reference Designs Available on [www.ti.com/lpw](http://www.ti.com/lpw)

Texas Instruments offers several antenna reference designs. For each reference design TI provides design files and documentation that show what kind of board the antenna was tested on and the measured performance. Common to all these designs is that the size and shape of the ground plane affects the performance of the antenna. Thus implementing the antennas on a PCB with different shape and size of the ground plane might result in slightly different results. It is important to make an exact copy of the dimensions of the antenna to obtain optimum performance. No ground plane or traces should be placed beneath the antenna. All the reference designs presented in chapter 7 and additional documentation can be downloaded from [www.ti.com/lpw](http://www.ti.com/lpw).

### 7.1 CC-Antenna-DK Reference Designs

The CC-Antenna-DK [43] contains 13 low cost antennas and 3 calibration boards. The antennas cover the frequency range as low as 136 MHz to 2.48 GHz; refer to Figure 1 and Figure 20.

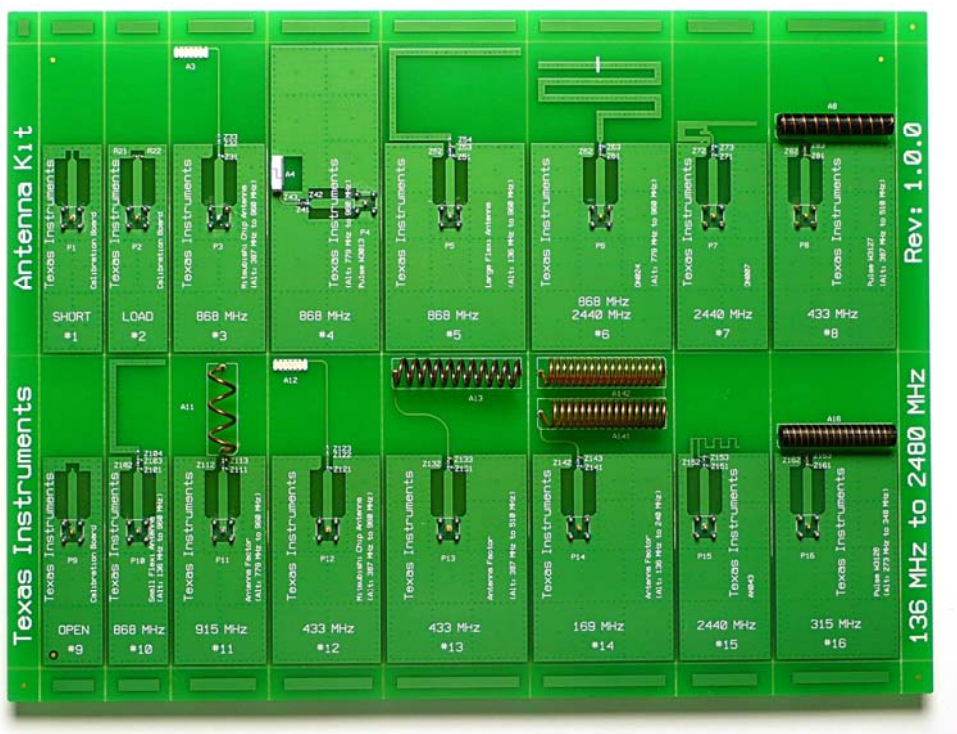

Figure 20. Texas Instruments Antenna Development Kit (CC-Antenna-DK)

Figure 20 and Table 5 shows the boards that are available on the CC-Antenna-DK [43]. Each CC-Antenna-DK [43] has been scribed (v-cut) so a specific board can easily be snapped out of the panel.

Nr.	Board Description	Freq. (MHz)
1	“SHORT” Calibration	-
2	“LOAD” Calibration	-
3	Mitsubishi Chip	868
4	Pulse Chip	868
5	Loaded Stud PCB (L)	868
6	Dual band Meander PCB Antenna	868 & 2440
7	Inverted-F PCB	2440
8	Pulse Helical Wire	433
9	“OPEN” Calibration	-
10	Loaded Stud PCB (S)	868
11	Helical Wire	915
12	Mitsubishi Chip	433
13	Helical Wire	433
14	Helical Wire	169
15	Meander PCB	2440
16	Pulse Helical Wire	315

**Table 5. Overview of Reference Design Available on CC-Antenna-DK**

OTA measurements as described in section 6.3 are available for each board on the CC-Antenna-DK [43]. The OTA measurements are according to the CTIA recommendations. The DN6xx series has been designated for OTA CTIA measurements.

## 7.2 2.4 GHz Antenna Reference Designs

### 7.2.1 Single Ended Antennas

For 2.4 GHz solutions, TI provides seven different antenna reference designs. Five of these are single ended antennas matched to 50 ohms. These can be used with all 2.4 GHz products as long as a 50 ohm balun is implemented. TI provides reference designs with a balun matched to 50 ohm for all 2.4 GHz products.

The antenna described in section 7.3.1.1 has a dual-band option which allows the antenna to operate at 2.4 GHz and 868 MHz. The antenna will be relatively large for 2.4 GHz operation but if dual band antenna is required then this is an ideal antenna.

#### 7.2.1.1 Meandered Inverted-F Antenna (AN043)

The smallest antenna solution for 2.4 GHz is a Meandered Inverted-F Antenna (MIFA) shown in Figure 21. This antenna is optimum for USB dongles and other implementations with limited board space. The antenna and its performance are described in Application Note 043 [3] and design files showing the layout is included in CC2511 USB Dongle Reference Design [9].



**Figure 21. CC-Antenna-DK Board 15 - Meandered Inverted-F Antenna**

## 7.2.1.2 Inverted-F Antenna (DN007)

The Inverted-F Antenna (IFA) shown in Figure 22 requires more board space than the MIFA, but provides a more omni-directional radiation pattern than the MIFA. This antenna can be found in the CC2400DB, CC2420DB and CC2430DB reference designs and the performance is documented in Design Note 007 [4]. The length of the IFA differs slightly between the various boards. The reason is that the length is tuned to compensate for the different sizes of the ground plane on the different boards.

The Inverted-F Antenna [4] has a higher efficiency than the Meandered Inverted-F Antenna and also has a wider bandwidth. **If PCB board area is sufficient to position the Inverted-F Antenna design [4], then this antenna is highly recommended for all single ended 2.4 GHz designs prior to other available solutions.**



Figure 22. CC-Antenna-DK Board 7 - Inverted-F Antenna

## 7.2.1.3 Ceramic Chip Antennas

For 2.4 GHz ISM band there are many suppliers of ceramic chip antennas. One chip antenna solution has been provided with Fractus [8.3], Application Note 048 [7] contains implementation recommendations and measurement results for a chip antenna implemented on a PCB with the size of a USB dongle. Figure 23 shows the required board space for this solution.

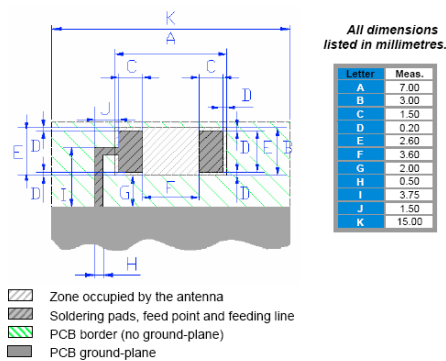

Figure 23. Fractus Footprint Details on the CC2400 USB Dongle

For other vendors of 2.4 GHz ceramic chip antennas please refer to section 8.3.

## 7.2.2 Differential Antennas

To reduce the number of external components required by a balun, it is possible to design a differential antenna that is matched directly to the impedance of the RF port of the radio. In some cases a few external components are required to obtain proper impedance matching or filtering.

CC2500, CC2510, CC2511 and CC2550 have all the same impedance. This makes it possible to use the antenna shown in Figure 24 with all these products. This antenna design and the measured performance are presented in Design Note 004 [5]. The only external components needed are two capacitors to ensure compliance with ETSI regulations. Thus for FCC compliance no external components are required if the proper output power and AUTCycling are used.

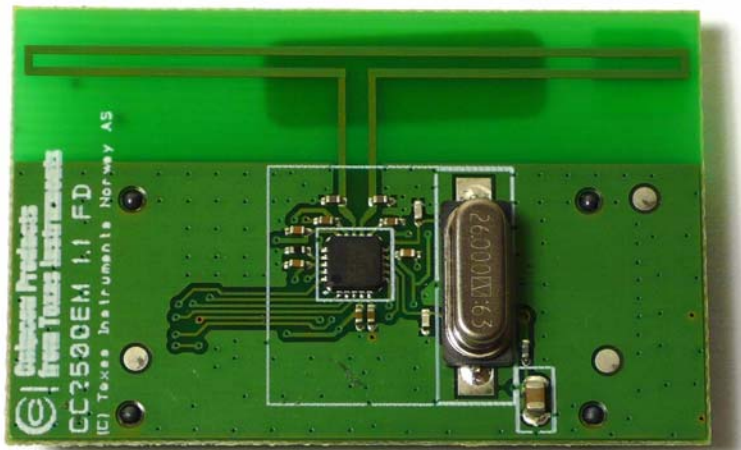

Figure 24. CC25xx Folded Dipole

CC2400, CC2420 and CC243x have all slightly different impedances. It is therefore necessary to use external components to tune the impedance so the same antenna structure can be used for all these products. The antenna presented in Application Note 040 [6] can be used with CC2400, CC2420 and CC243x if the inductor sitting between the RF pins is tuned accordingly. In addition to the tuning inductor it is recommended to use an inductor in series with the TXRX switch pin. This inductor works as a RF choke at 2.4 GHz.

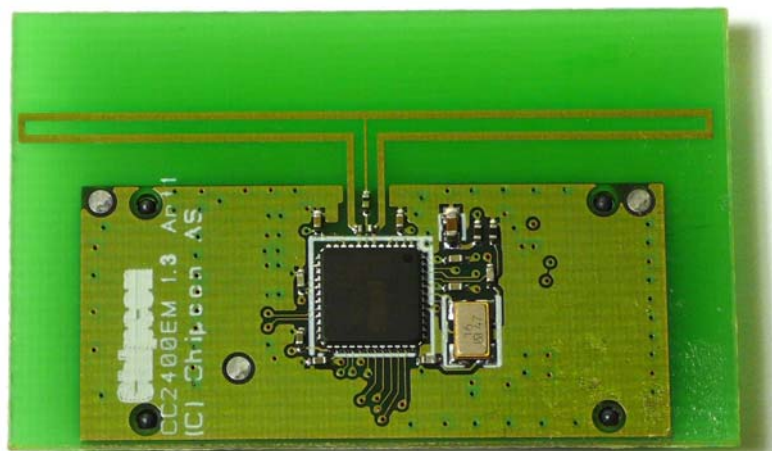

Figure 25. CC24xx Folded Dipole



## 7.2.3 YAGI PCB Directional Antenna

Referring to Figure 26, applications environments such as corridor coverage, metering surveillance, and maximum range distance between two fixed devices can be ideal applications for the YAGI type of directivity antenna. This antenna design and the measured performance are presented in Design Note 034 [49].

One advantage of using a directional antenna is the PA power can be reduced due to the higher gain in the antenna between two devices for a given distance so that current consumption can be reduced. Another advantage is that the antenna gain can be utilized to achieve a greater range distance between two devices.

The gain of the antenna shown in Figure 26 is approx 7 dBi, compared to a more omni-directional antenna with a gain in the region 2 to 3 dBi. Theoretically, by increasing the gain by 6 dB, the range will be doubled in a specific direction.

As mentioned in Section 6.3, the antenna gain is just a measure of the antenna directivity and an antenna can only radiated the power that is entered into the antenna. A disadvantage of using directional antennas is that the positioning of the transmitter and receiver unit must be known in detail. If this information is not known then it is best to use a more omni-directional antenna design such as the inverted-F antenna in Section 7.2.1.2.

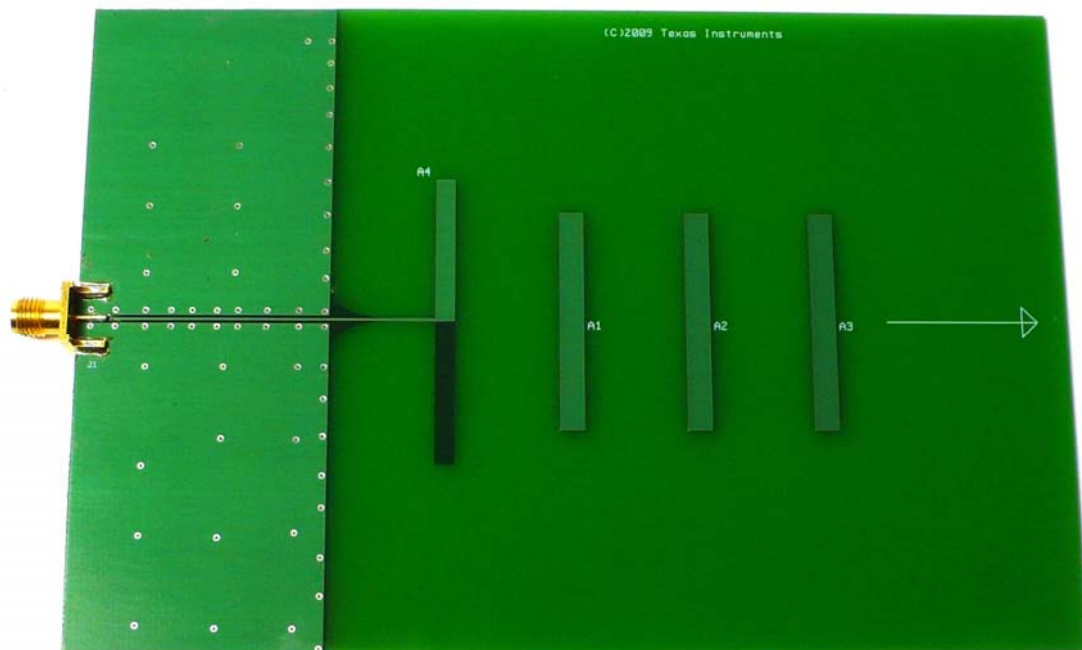

Figure 26. 2.4 GHz PCB YAGI Antenna

## 7.3 Sub 1 GHz Antenna Reference Designs

### 7.3.1 Reference Designs for 868/915/955 MHz Antennas

For 868/915/955 MHz operation, TI offers eight reference designs that can be used with all RF products capable of operating at these frequencies. Five designs are pure PCB antennas and the other three are chip antennas. All designs are matched to 50 ohm. Thus a balun is needed for all products with differential output.

#### 7.3.1.1 Meandering Monopole with Dual Band Option (DN024)

The first PCB antenna consists of a meandering monopole antenna and is a medium-size, low-cost solution. Figure 27 shows the meandering monopole EM board for 868/915/955 MHz. More information about this design can be found in Design Note 024 [18] and 868/915/955 MHz Meandering Monopole PCB Antenna Reference Design [19]

**If PCB board area is sufficient to position the Meandering Monopole Antenna design [4], then this antenna is highly recommended for all single ended 868 / 915 / 955 MHz designs prior to other available solutions.**

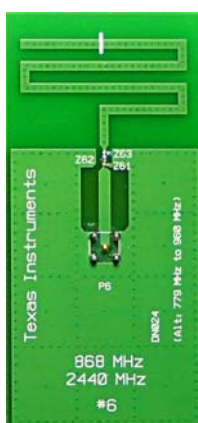

Figure 27. CC-Antenna-DK Board 6 - Meandering Monopole Antenna for 868/915/955 MHz

#### 7.3.1.2 Inverted-F Antenna for 868/915/955 MHz (DN023)

The second PCB antenna consists of an Inverted-F antenna and is a medium-size, low-cost solution. Figure 28 shows the Inverted-F antenna EM board for 868/915/955 MHz. More information about this design can be found in Design Note 023 [17] and 868/915/955 MHz PCB Inverted-F Antenna Reference Design [18].



Figure 28. Inverted-F Antenna EM board for 868/915/955 MHz

## 7.3.1.3 CC-Antenna-DK – Loaded Stub Antenna (Large)

The third PCB antenna consists of a loaded stub antenna and is a medium-size, low-cost solution. Figure 29 shows loaded stub antenna board 5 from the CC-Antenna-DK for 868/915/955 MHz. More information about this design can be found in the CC-Antenna-DK [29].

This type of antenna approach is ideal when no other antenna reference design can be used so this design illustrates that by routing the antenna element for a given area and then by matching the antenna with a loaded element (typically an inductor), then the resonance and good radiation performance can be achieved without the need of simulations. This board is similar to 7.3.1.4 with the only difference being the antenna area is larger.



Figure 29. CC-Antenna-DK Board 5 - Loaded Stub Antenna (Large) for 868/915/955 MHz

## 7.3.1.4 CC-Antenna-DK – Loaded Stub Antenna (Small)

The fourth PCB antenna consists of a loaded stub antenna and is a small-size, low-cost solution. Figure 30 shows loaded stub antenna board 10 from the CC-Antenna-DK for 868/915/955 MHz. More information about this design can be found in the CC-Antenna-DK [29].

As mentioned in section 7.3.1.3, this type of antenna approach is ideal when no other antenna reference design can be used. This board is similar to 7.3.1.3 with the only difference being the antenna area is smaller.



Figure 30. CC-Antenna-DK Board 10 - Loaded Stub Antenna (Small) for 868/915/955 MHz



## 7.3.1.5 CC-Antenna-DK – Mitsubishi Chip Antenna

The fifth antenna design consists of a ceramic chip antenna from Mitsubishi [8.6] and is a small-size, medium-cost solution. Figure 31 shows the Mitsubishi ceramic chip antenna board 3 from the CC-Antenna-DK for 868/915/955 MHz. More information about this design can be found in DN033 [48] and in the CC-Antenna-DK [29].

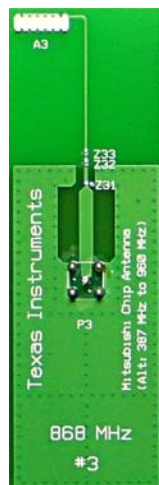

Figure 31. CC-Antenna-DK Board 3 - Mitsubishi Chip Antenna for 868/915/955 MHz

## 7.3.1.6 CC-Antenna-DK – Pulse Chip Antenna

The sixth antenna design consists of a ceramic chip antenna from Pulse [8.6] and is a small-size, medium-cost solution. Figure 32 shows the Pulse ceramic chip antenna board 4 from the CC-Antenna-DK for 868 MHz. The antenna can be tuned for 915 MHz and 955 MHz as well by changing the distance to the GND cavity. More information about this design can be found in the CC-Antenna-DK [29].

An advantage with this design is the antenna can be placed in the middle, at the edge of the board with GND around the whole antenna. Advantageous when board space is becoming limited.

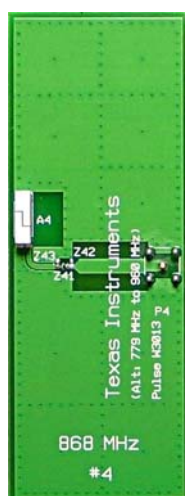

Figure 32. CC-Antenna-DK Board 4 - Pulse Chip Antenna for 868MHz

## 7.3.1.7 CC-Antenna-DK – Helical Wire Antenna

The seventh antenna design consists of a helical wire antenna and is a small-size, low-cost solution. Figure 33 shows the helical wire antenna board 11 from the CC-Antenna-DK for 915 MHz. The antenna can be tuned for 868 MHz and 955 MHz as well by changing the match values. More information about this design can be found in the CC-Antenna-DK [29].

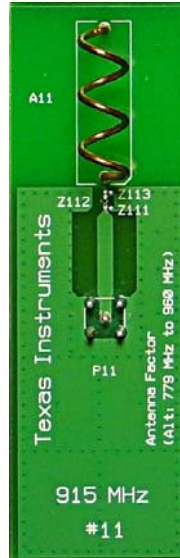

Figure 33. CC-Antenna-DK Board 11 – Helical Wire Antenna for 915 MHz

## 7.3.1.8 DN016 - Johanson Technologies Chip Antenna

The eighth antenna design consists of a ceramic chip antenna from Johanson Technologies and is a small-size, medium-cost solution. This is a compact antenna solution for 868/915/955 MHz and is shown in Figure 34. It consists of a chip antenna from Johanson Technology [8.6] in conjunction with a special PCB trace. Design recommendations and measurement results are presented in Design Note 016 [8].



Figure 34. Chip Antenna from Johanson Technology for 868/915/955 MHz

## 7.3.2 Reference Designs for 433 MHz Antennas

For 433 MHz operation, TI offers three reference designs that can be used with all RF products capable of operating at these frequencies. Two designs are helical wire antennas and the third design is a chip antenna. All designs are matched to 50 ohm.

### 7.3.2.1 CC-Antenna-DK – Pulse Helical Wire Antenna

The first and recommended design at 433 MHz is a helical wire antenna and is a small-size, low-cost solution from Pulse [8.6]. Figure 35 shows the helical wire antenna board 8 from the CC-Antenna-DK for 433 MHz. More information about this design can be found in the CC-Antenna-DK [29].

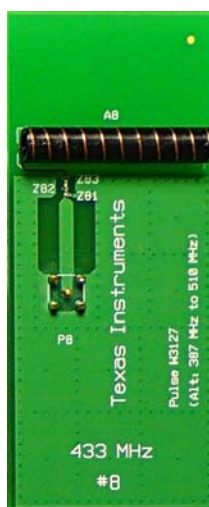

Figure 35. CC-Antenna-DK Board 8 - Pulse Helical Wire Antenna for 433 MHz

### 7.3.2.2 CC-Antenna-DK – Helical Wire Antenna

The second design at 433 MHz is a helical wire antenna and is a medium-size, low-cost solution. Figure 36 shows the helical wire antenna board 13 from the CC-Antenna-DK for 433 MHz. More information about this design can be found in the CC-Antenna-DK [29].

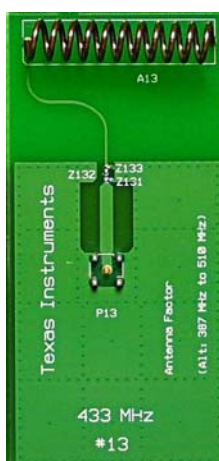

Figure 36. CC-Antenna-DK Board 13 – Helical Wire Antenna for 433 MHz

## 7.3.2.3 CC-Antenna-DK – Mitsubishi Chip Antenna

The third antenna design consists of a ceramic chip antenna from Mitsubishi and is a low-size, low-cost solution. Figure 37 shows the Mitsubishi ceramic chip antenna board 3 from the CC-Antenna-DK for 868/915/955 MHz. More information about this design can be found in DN033 [48] and in the CC-Antenna-DK [29]. The efficiency of the chip antenna at 433 MHz is lower than the helical wire antenna solutions in described in section 7.3.2.1 & 7.3.2.2.

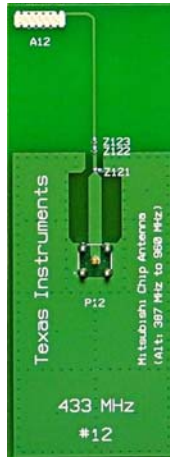

Figure 37. CC-Antenna-DK Board 12 - Mitsubishi Chip Antenna for 433 MHz

## 7.3.3 Reference Designs for 315 MHz Antennas

For 315 MHz operation, TI offers a reference designs that can be used with all RF products capable of operating at this frequency. The design is matched to 50 ohm.

### 7.3.3.1 CC-Antenna-DK – Pulse Helical Wire Antenna

The recommended design at 315 MHz is a helical wire antenna and is a small-size, low-cost solution from Pulse [8.6]. Figure 38 shows the helical wire antenna board 16 from the CC-Antenna-DK for 315 MHz. More information about this design can be found in the CC-Antenna-DK [29].

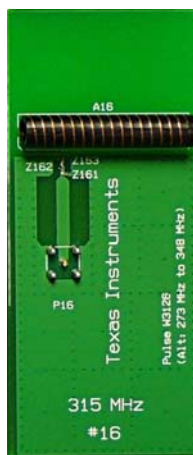

Figure 38. CC-Antenna-DK Board 16 - Pulse Helical Wire Antenna for 315 MHz

## 7.3.4 Reference Designs for 169 MHz Antennas

For 169 MHz operation of in the frequency band 136 to 240 MHz, TI offers a reference designs that can be used with all RF products capable of operating at this frequency.

### 7.3.4.1 CC-Antenna-DK – Helical Wire Antenna

The recommended design at 169 MHz (136 MHz to 240 MHz) consists of two helical wire antennas in series and is a relative small-size for the frequency band, low-cost solution. Figure 39 shows the helical wire antenna board 14 from the CC-Antenna-DK for 169 MHz. More information about this design can be found in the CC-Antenna-DK [29].

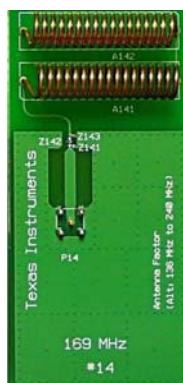

Figure 39. CC-Antenna-DK Board 14 – Helical Wire Antenna for 169 MHz (136 – 240 MHz)

## 8 Additional Antenna Resources

There exists a lot of literature discussing antenna types and antenna theory. Several companies offer EM simulation tools applicable for antenna simulation. There are also many companies that manufacture antennas and also companies offering consultant services to do custom antenna design. This section lists different antenna resources.

### 8.1 Antenna Literature

There exist a large number of publications covering antennas. Table 6 lists some relevant literature dealing with this topic.

Title	Author
Antenna Theory and Design	Warren L. Stutzman & Garry A. Thiele
Antenna Handbook	Y. T. Lo & S. W Lee
Microwave & RF Design of Wireless Systems	David M. Pozar

Table 6. Antenna Literature

### 8.2 EM Simulation Tools

Table 7 lists Electro Magnetic simulation tools that can be used to perform antenna simulations. The list is given as a reference only as TI has not evaluated all these programs.

Tool	Company	Web page
IE3D	Zeland	<a href="http://www.zeland.com/">http://www.zeland.com/</a>
Momentum	Agilent	<a href="http://eesof.tm.agilent.com/products/momentum_main.html">http://eesof.tm.agilent.com/products/momentum_main.html</a>
HFSS	Ansoft	<a href="http://www.ansoft.com/products/hf/hfss/">http://www.ansoft.com/products/hf/hfss/</a>

Table 7. EM Simulation Tools

# Application Note AN058

## 8.3 Smith Charts – Antenna Matching

The following software is freeware or costs a very small amount to register.

Tool Description	Company	Web page
Excel format - Smith Chart Matching	-	<a href="http://www.maka-fss.de/">http://www.maka-fss.de/</a>
Smith Chart Matching	Bern University	<a href="http://www.fritz.dellsperger.net/">http://www.fritz.dellsperger.net/</a>

## 8.4 Gerber Viewers

The following software is freeware or costs a very small amount to register.

Tool Description	Company	Web page
ViewMATE	Pentalogix	<a href="http://www.pentalogix.com/">http://www.pentalogix.com/</a>
GC-Prevue	Graphiccode	<a href="http://www.graphiccode.com/">http://www.graphiccode.com/</a>

## 8.5 E2E Community

The following link is to the TI Engineer to Engineer Community: <http://e2e.ti.com/>

## 8.6 Antenna Suppliers and Consultants

It is difficult to design small and effective antennas and even if a chip antenna is chosen it is often necessary to perform impedance matching to obtain optimum performance [3.4]. Most chip antenna suppliers will assist in tuning the antenna for a specific board design if the sales potential is significant. Otherwise, it could be wise to contact a RF consultant for assistance or if a special antenna solution is required. Below is a selection of companies that can assist with antenna designs.

Company	Web page	Antenna Expertise
Mitsubishi	<a href="http://www.mmea.com/">http://www.mmea.com/</a>	Chip Antennas
Pulse	<a href="http://www.lkproducts.com/">http://www.lkproducts.com/</a>	Chip Antennas Helical Wire Antennas
Johanson Technologies	<a href="http://www.johansontechnology.com/">http://www.johansontechnology.com/</a>	Chip Antennas
Fractus	<a href="http://www.fractus.com/">http://www.fractus.com/</a>	Chip Antennas IP Compact Antennas
Antenova	<a href="http://www.antenova.com/">http://www.antenova.com/</a>	Chip Antennas Whip Antennas
Nearson	<a href="http://www.nearson.com/">http://www.nearson.com/</a>	Whip Antennas
Badland	<a href="http://www.badland.co.uk/">http://www.badland.co.uk/</a>	Whip Antennas
Linx Technologies	<a href="http://www.linxtechnologies.com/">http://www.linxtechnologies.com/</a>	Whip Antennas
WSI	<a href="http://www.wsi.nu/">http://www.wsi.nu/</a>	European Antenna Consultant
Antennasys	<a href="http://www.antennasys.com">http://www.antennasys.com</a>	American Antenna Consultant
LS Research	<a href="http://www.lsr.com/">http://www.lsr.com/</a>	American Antenna Consultant
Pinyon	<a href="http://www.pinyontech.com/">http://www.pinyontech.com/</a>	IP Directional antennas

Table 8. Antenna Suppliers and Consultants

## 9 Summary

This application note gives an overview of antenna theory, different types of antennas available, parameters to consider when implementing an antenna, antenna measurement methods and different antenna reference designs available at [www.ti.com/lpw](http://www.ti.com/lpw).

In addition to this comprehensive antenna selection guide document, there is an Antenna Selection Quick Guide [50] available which is a one sheet document that gives a complete overview of the Antenna Support Documentation available. Figure 40 shows the DN035, Antenna Selection Quick Guide document [50]. Figure 41 illustrates the recommended document flow for the antenna support documentation.

Antenna Selection Quick Guide							DN035
Design / Application Note	<a href="#">DN007</a>	<a href="#">AN043</a>	<a href="#">DN004</a>	<a href="#">AN040</a>	<a href="#">DN024</a>	<a href="#">DN034</a>	<a href="#">AN048</a>
Frequency	2.4 GHz	2.4 GHz	2.4 GHz	2.4 GHz	2.4 GHz	2.4 GHz	2.4 GHz
Typical Efficiency	80 %(EB) 94 %(SA)	88 %(EB)	80 %(EB)	80 %(EB)	76 %(EB) 87 %(SA)	72 %(SA)	55 %(USB)
Bandwidth @ VSWR 2:0	280 MHz	101 MHz	100 MHz	80 MHz	400 MHz	497 MHz	150 MHz
Dimensions (mm)	26 x 8	15 x 6	46 x 9	48 x 8	39 x 25	150 x 100	7 x 3
Design / Application Note	<a href="#">DN024</a>	<a href="#">DN023</a>	<a href="#">DN031</a>	<a href="#">DN031</a>	<a href="#">DN033</a>	<a href="#">DN031</a>	<a href="#">DN016</a>
Frequency	868 / 915 / 955 MHz	868 / 915 / 955 MHz	868 / 915 / 955 MHz	868 / 915 / 955 MHz	868 / 915 / 955 MHz	868 / 915 / 955 MHz	868 / 915 / 955 MHz
Typical Efficiency	64 %(EB) 91 %(SA)	80 %(SA)	69 %(EB)	64 %(EB)	49 %(EB)	63 %(EB)	20 %(EB)
Bandwidth @ VSWR 2:0	46 MHz	40 MHz	62 MHz	56 MHz	56 MHz	8 MHz	21 MHz
Dimensions (mm)	39 x 25	43 x 20	10 x 28	48 x 8	15 x (5 to 29)	10 x 14	9 x 8
Design / Application Note	<a href="#">DN031</a>	<a href="#">DN031</a>	<a href="#">DN031</a>	<a href="#">DN031</a>	<a href="#">DN031</a>	<b>Antenna Support Documentation</b> 	
Frequency	433 MHz	433 MHz	433 MHz	315 MHz	136 - 240 MHz		
Typical Efficiency	20 %(EB)	26 %(EB)	15 %(EB)	15 %(EB)	7 %(EB)		
Bandwidth @ VSWR 2:0	23 MHz	38 MHz	30 MHz	4 MHz	3 MHz		
Dimensions (mm)	37 x 9	42 x (10 to 29)	15 x (5 to 29)	37 x 9	42 x (22 to 29)		
ER SmartRF Evaluation Board SA Stand-Alone		SWRA351		By Richard Wallace			

Figure 40. DN035 – Antenna Selection Quick Guide

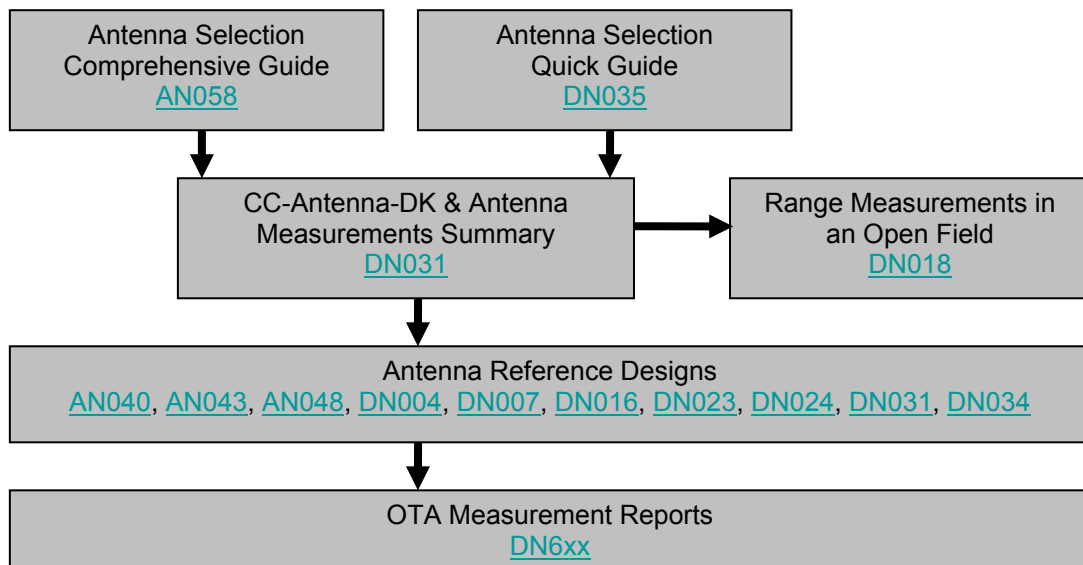

Figure 41. Recommended Document Flow for Antenna Reference Designs



# Application Note AN058

Table 9 lists all the antenna reference designs available at [www.ti.com/lpw](http://www.ti.com/lpw). This table lists which products the different antennas can be used with, the required PCB size to implement the antenna and main properties. It does also lists where to find more information on the different designs.

Reference design	Products	Size in mm	Properties	Doc. Nr.
2.4 GHz PCB Meandered Inverted-F Antenna	All 2.4 GHz products	15 x 6	PCB Meandered Inverted-F Antenna, Small size & small BW	<a href="#">AN043</a> <a href="#">DN031</a>
2.4 GHz PCB Inverted-F Antenna	All 2.4 GHz products	26 x 8	PCB Inverted-F Antenna Small size, large BW & easy to tune	<a href="#">DN007</a> <a href="#">DN031</a>
CC2500 Folded Dipole	CC2500 CC2550 CC2510 CC2511	46 x 9	Folded Dipole Antenna Large size & hard to tune High gain	<a href="#">DN004</a>
CC2400 Folded Dipole	CC2400 CC2420 CC2430 CC2431	48 x 8	Folded Dipole Antenna Large size & hard to tune High gain	<a href="#">AN040</a>
2.4 GHz chip antenna	All 2.4 GHz products	7 x 3	Chip Antenna Small size & easy to tune Medium performance	<a href="#">AN048</a>
Board 6 CC-Antenna-DK	Dual band 2.4 GHz & 868 MHz	39 x 25	Meandering Monopole Antenna, Large size for 2.4 GHz operation	<a href="#">DN031</a>
2.4 GHz YAGI PCB Antenna	All 2.4 GHz products	150 x 100	Directional YAGI Antenna	<a href="#">DN034</a>

**Table 9. Reference Designs Available on [www.ti.com/lpw](http://www.ti.com/lpw) at 2.4 GHz**

Reference design	Products	Size in mm	Properties	Doc. Nr.
Meandering Monopole PCB antenna	All 868/915/955 MHz products	38 x 24	Meandering Monopole Antenna, Medium size & easy to tune	<a href="#">DN024</a> <a href="#">DN031</a>
PCB Inverted-F Antenna	All 868/915/955 MHz products	43 x 20	Inverted-F Antenna Medium size & easy to tune	<a href="#">DN023</a>
Board 5 CC-Antenna-DK Loaded Stub	All 868/915/955 MHz products	40 x 28	Loaded Stub Antenna, Large size & easy to tune	<a href="#">DN031</a>
Board 10 CC-Antenna-DK Loaded Stub	All 868/915/955 MHz products	18 x 28	Loaded Stub Antenna, Small size & easy to tune	<a href="#">DN031</a>
Board 3 CC-Antenna-DK Mitsubishi Chip	All 868/915/955 MHz products	15 x (5 to 29)	Mitsubishi Chip Antenna Small to medium size & easy to tune	<a href="#">DN033</a> <a href="#">DN031</a>
Board 4 CC-Antenna-DK Pulse Chip	All 868/915/955 MHz products	10 x 14	Pulse Chip Antenna Small size	<a href="#">DN031</a>
Board 11 CC-Antenna-DK Helical Wire	All 868/915/955 MHz products	10 x 28	Helical Wire Antenna Small size & easy to tune	<a href="#">DN031</a>
CC1111 USB Dongle	All 868/915/955 MHz products	9 x 8	Chip Antenna Small size & easy to tune	<a href="#">DN016</a>

**Table 10. Reference Designs Available on [www.ti.com/lpw](http://www.ti.com/lpw) at 868 / 915 / 955 MHz**



# Application Note AN058

Reference design	Products	Size in mm	Properties	Doc. Nr.
Board 8 CC-Antenna-DK Loaded Stub	All 433 MHz products	37 x 9	Pulse Helical Wire Antenna, Small size & easy to tune	<a href="#">DN031</a>
Board 13 CC-Antenna-DK Loaded Stub	All 433 MHz products	42 x (10 to 29)	Helical Wire Antenna, Medium size & easy to tune	<a href="#">DN031</a>
Board 12 CC-Antenna-DK Loaded Stub	All 433 MHz products	15 x (5 to 29)	Mitsubishi Chip Antenna Small to medium size & easy to tune	<a href="#">DN031</a>
Board 16 CC-Antenna-DK Loaded Stub	All 315 MHz products	37 x 9	Pulse Helical Wire Antenna, Small size & easy to tune	<a href="#">DN031</a>
Board 14 CC-Antenna-DK Mitsubishi Chip	All 136 to 240 MHz products	42 x (22 to 29)	Helical Wire Antenna, Small size & easy to tune	<a href="#">DN031</a>

**Table 11. Reference Designs Available on [www.ti.com/lpw](http://www.ti.com/lpw) at 433 / 315 / 136-240 MHz**

There is a large amount of general antenna documentation available at [www.ti.com/lpw](http://www.ti.com/lpw). Refer to the References section [10] for hyperlinks and further antenna information.

Our ambition is to provide excellent design and application notes so the design-in process will be easier and quicker. With RF designs, the antenna design is a critical stage to be able to achieve the best possible link budget for a specific application. The antenna application notes are updated regularly and updated with new designs. The TI antenna designs that are released are free of charge and can be used directly in the final application design.

The antenna in the basic form, IFA, patch, spiral etc is generally free from patent infringement because these are well known designs that have been around for many years. When the antenna is adapted from the "standard format"; then the antennas are more than likely protected through patents. It is important to keep this in mind when developing a new antenna. Many antenna patents collide with each other and which company had the original IP, and if the IP is valid can be a long discussion. It is advisable to keep to the standard text book antenna designs when developing an antenna to avoid any legal discussions.

With the introduction of the CC-Antenna-DK [29]; new antenna reference designs have been made to cover the whole frequency spectrum from 136 MHz to 2480 MHz with full OTA CTIA measurement reports.

This document covers a large amount of various antenna design and antenna concepts. The ambition is to provide a wide spectrum of antenna designs so that the final application can choose an optimum solution for their needs. There are no general recommendations for any particular antenna supplier or antenna type.

# Application Note AN058

## 10 References

- [1] AN001 - SRD Regulations for License Free Transceiver Operation ([swra090.pdf](#))
- [2] AN032 - 2.4 GHz Regulations ([swra060.pdf](#))
- [3] AN043 - Small Size 2.4 GHz PCB antenna ([swra117.pdf](#))
- [4] DN007 - 2.4 GHz Inverted-F Antenna ([swru120.pdf](#))
- [5] DN004 - Folded Dipole Antenna for CC25xx ([swra118.pdf](#))
- [6] AN040 - Folded dipole antenna for CC2400, CC2420 and CC2430/31 ([swra093.pdf](#))
- [7] AN048 - 2.4GHz Chip Antenna ([swra092.pdf](#))
- [8] DN016 - Compact 868/915 MHz Antenna Design ([swra160.pdf](#))
- [9] CC2511 USB-Dongle Reference Design ([swrc062.zip](#))
- [10] CC2430DB Reference Design ([swrr034.zip](#))
- [11] CC2420DB Reference Design ([swrr019.zip](#))
- [12] CC2400DB Reference Design ([swrr020.zip](#))
- [13] CC25xxEM Folded Dipole Reference Design ([swrc065.zip](#))
- [14] CC2400EM Folded Dipole Reference Design ([swra093.zip](#))
- [15] CC1111 USB Dongle Reference Design ([swrr049.zip](#))
- [16] CC1110EM IIFA Reference Design ([swrr058.zip](#))
- [17] DN023 - 868/915 MHz PCB Inverted-F Antenna Design ([swra228.pdf](#))
- [18] DN024 - 868/915 MHz Meandering Monopole PCB Antenna ([swra227.pdf](#))
- [19] CC1110EM Meander Antenna Reference Design ([swra059.zip](#))
- [20] DN026 - CC2430 with  $\frac{1}{4}$  wave Pinyon Antenna Design Note ([swra251.pdf](#))
- [21] DN027 - CC2430 with half wave Pinyon Antenna Ref. Design Note ([swra252.pdf](#))
- [22] DN028 - CC2510 with  $\frac{1}{4}$  wave Pinyon Antenna Ref. Design Note ([swra253.pdf](#))
- [23] DN029 - CC2510 with half wave Pinyon Antenna Ref. Design Note ([swra254.pdf](#))
- [24] CC2430 with  $\frac{1}{4}$  wave Pinyon Antenna Ref. Design ([swrc114.zip](#))
- [25] CC2430 with half wave Pinyon Antenna Ref. Design ([swrc113.zip](#))
- [26] CC2510 with  $\frac{1}{4}$  wave Pinyon Antenna Ref. Design ([swrc116.zip](#))
- [27] CC2510 with half wave Pinyon Antenna Ref. Design ([swrc115.zip](#))

# *Application Note AN058*

- [28] DN018 - Range Measurements in an Open Field Environment ([swra169.pdf](#))
- [29] DN031 – CC-Antenna-DK Documentation and Antenna Measurements Summary ([swra328.pdf](#))
- [30] DN600 – CTIA Measurement Report for board 3 ([swra329.pdf](#))
- [31] DN601– CTIA Measurement Report for board 4 ([swra330.pdf](#))
- [32] DN602 – CTIA Measurement Report for board 5 ([swra331.pdf](#))
- [33] DN603 – CTIA Measurement Report for board 6 ([swra332.pdf](#))
- [34] DN604 - CTIA Measurement Report for board 7 ([swra333.pdf](#))
- [35] DN605 - CTIA Measurement Report for board 8 ([swra334.pdf](#))
- [36] DN606 - CTIA Measurement Report for board 10 ([swra335.pdf](#))
- [37] DN607 – CTIA Measurement Report for board 11 ([swra336.pdf](#))
- [38] DN608 – CTIA Measurement Report for board 12 ([swra337.pdf](#))
- [39] DN609 – CTIA Measurement Report for board 13 ([swra338.pdf](#))
- [40] DN610 – CTIA Measurement Report for board 14 ([swra339.pdf](#))
- [41] DN611 – CTIA Measurement Report for board 15 ([swra340.pdf](#))
- [42] DN612 – CTIA Measurement Report for board 16 ([swra341.pdf](#))
- [43] DN613 - CTIA Measurement Report for Standard Whip Antenna for 868 MHz & 915 MHz EM boards ([swra342.pdf](#))
- [44] DN614 - CTIA Measurement Report for Standard Whip Antenna for 2.4 GHz EM boards ([swra343.pdf](#))
- [45] DN615 - CTIA Measurement Report for Board 7 as stand alone (without EM or EB board) ([swra344.pdf](#))
- [46] DN616 - CTIA Measurement Report for - Board 6 as stand alone (without EM or EB board) ([swra345.pdf](#))
- [47] CC-Antenna-DK Rev 1.0.0. Reference Design ([swrr070.zip](#))
- [48] DN033 – Mitsubishi Ceramic Antenna for 868, 915 & 955 MHz ([swra307.pdf](#))
- [49] DN034 – YAGI PCB Antenna for 2.4 GHz ([swra350.pdf](#))
- [50] DN035 – Antenna Selection Quick Guide ([swra351.pdf](#))

## 11 General Information

### 11.1 Document History

Revision	Date	Description/Changes
SWRA161	2007-11-26	Initial release.
SWRA161A	2009-06-01	Updated
SWRA161B	2010-10-05	Updated with new antenna reference designs, more antenna theory and more resources info

## IMPORTANT NOTICE

Texas Instruments Incorporated and its subsidiaries (TI) reserve the right to make corrections, modifications, enhancements, improvements, and other changes to its products and services at any time and to discontinue any product or service without notice. Customers should obtain the latest relevant information before placing orders and should verify that such information is current and complete. All products are sold subject to TI's terms and conditions of sale supplied at the time of order acknowledgment.

TI warrants performance of its hardware products to the specifications applicable at the time of sale in accordance with TI's standard warranty. Testing and other quality control techniques are used to the extent TI deems necessary to support this warranty. Except where mandated by government requirements, testing of all parameters of each product is not necessarily performed.

TI assumes no liability for applications assistance or customer product design. Customers are responsible for their products and applications using TI components. To minimize the risks associated with customer products and applications, customers should provide adequate design and operating safeguards.

TI does not warrant or represent that any license, either express or implied, is granted under any TI patent right, copyright, mask work right, or other TI intellectual property right relating to any combination, machine, or process in which TI products or services are used. Information published by TI regarding third-party products or services does not constitute a license from TI to use such products or services or a warranty or endorsement thereof. Use of such information may require a license from a third party under the patents or other intellectual property of the third party, or a license from TI under the patents or other intellectual property of TI.

Reproduction of TI information in TI data books or data sheets is permissible only if reproduction is without alteration and is accompanied by all associated warranties, conditions, limitations, and notices. Reproduction of this information with alteration is an unfair and deceptive business practice. TI is not responsible or liable for such altered documentation. Information of third parties may be subject to additional restrictions.

Resale of TI products or services with statements different from or beyond the parameters stated by TI for that product or service voids all express and any implied warranties for the associated TI product or service and is an unfair and deceptive business practice. TI is not responsible or liable for any such statements.

TI products are not authorized for use in safety-critical applications (such as life support) where a failure of the TI product would reasonably be expected to cause severe personal injury or death, unless officers of the parties have executed an agreement specifically governing such use. Buyers represent that they have all necessary expertise in the safety and regulatory ramifications of their applications, and acknowledge and agree that they are solely responsible for all legal, regulatory and safety-related requirements concerning their products and any use of TI products in such safety-critical applications, notwithstanding any applications-related information or support that may be provided by TI. Further, Buyers must fully indemnify TI and its representatives against any damages arising out of the use of TI products in such safety-critical applications.

TI products are neither designed nor intended for use in military/aerospace applications or environments unless the TI products are specifically designated by TI as military-grade or "enhanced plastic." Only products designated by TI as military-grade meet military specifications. Buyers acknowledge and agree that any such use of TI products which TI has not designated as military-grade is solely at the Buyer's risk, and that they are solely responsible for compliance with all legal and regulatory requirements in connection with such use.

TI products are neither designed nor intended for use in automotive applications or environments unless the specific TI products are designated by TI as compliant with ISO/TS 16949 requirements. Buyers acknowledge and agree that, if they use any non-designated products in automotive applications, TI will not be responsible for any failure to meet such requirements.

Following are URLs where you can obtain information on other Texas Instruments products and application solutions:

<b>Products</b>		<b>Applications</b>	
Amplifiers	<a href="http://amplifier.ti.com">amplifier.ti.com</a>	Audio	<a href="http://www.ti.com/audio">www.ti.com/audio</a>
Data Converters	<a href="http://dataconverter.ti.com">dataconverter.ti.com</a>	Automotive	<a href="http://www.ti.com/automotive">www.ti.com/automotive</a>
DLP® Products	<a href="http://www.dlp.com">www.dlp.com</a>	Communications and Telecom	<a href="http://www.ti.com/communications">www.ti.com/communications</a>
DSP	<a href="http://dsp.ti.com">dsp.ti.com</a>	Computers and Peripherals	<a href="http://www.ti.com/computers">www.ti.com/computers</a>
Clocks and Timers	<a href="http://www.ti.com/clocks">www.ti.com/clocks</a>	Consumer Electronics	<a href="http://www.ti.com/consumer-apps">www.ti.com/consumer-apps</a>
Interface	<a href="http://interface.ti.com">interface.ti.com</a>	Energy	<a href="http://www.ti.com/energy">www.ti.com/energy</a>
Logic	<a href="http://logic.ti.com">logic.ti.com</a>	Industrial	<a href="http://www.ti.com/industrial">www.ti.com/industrial</a>
Power Mgmt	<a href="http://power.ti.com">power.ti.com</a>	Medical	<a href="http://www.ti.com/medical">www.ti.com/medical</a>
Microcontrollers	<a href="http://microcontroller.ti.com">microcontroller.ti.com</a>	Security	<a href="http://www.ti.com/security">www.ti.com/security</a>
RFID	<a href="http://www.ti-rfid.com">www.ti-rfid.com</a>	Space, Avionics & Defense	<a href="http://www.ti.com/space-avionics-defense">www.ti.com/space-avionics-defense</a>
RF/IF and ZigBee® Solutions	<a href="http://www.ti.com/lprf">www.ti.com/lprf</a>	Video and Imaging	<a href="http://www.ti.com/video">www.ti.com/video</a>
		Wireless	<a href="http://www.ti.com/wireless-apps">www.ti.com/wireless-apps</a>

Mailing Address: Texas Instruments, Post Office Box 655303, Dallas, Texas 75265  
Copyright © 2010, Texas Instruments Incorporated