

Trends in high resolution headlamps

Jeff Farris and Brian Ballard

ABSTRACT

A version of this paper was originally published at the [2018 SIA VISION congress](#). Texas Instruments DLP® Products introduced the DLP5531-Q1 automotive chipset, with an extended high-temperature operating range and over 1.3 million micromirrors. Configured to maximize optical efficiency and enable compact system packaging, this device is uniquely suited for emerging high resolution forward lighting applications. This paper provides an overview of device details that enable cost- and performance-optimized high resolution headlights enabled by DLP technology. This paper also reveals why megapixel resolutions are not only useful, but a fundamental requirement for many emerging headlight concepts. New opportunities and areas for further research enabled exclusively by megapixel resolutions are proposed. Finally, we propose new laser illumination concepts that achieve the brightness levels necessary for full adaptive-beam field of view (FOV) requirements with reasonable power efficiency and a minimum total number of headlamp modules.

Contents

1	Introduction	3
2	DLP Products Resolution	3
3	High luminance concept for full FOV with high efficiency	12
4	Conclusion	18
5	Acknowledgement	18
6	References	18
7	Glossary	18

List of Figures

1	1.3 million micromirrors in a diamond pixel format	3
2	Bottom illumination example	4
3	Orthogonal sampling and display	5
4	Diamond display lattice	5
5	Relative pixel center spacing	6
6	Orthogonal to diamond mapping using the DLPC230-Q1 controller chip 1152 × 576 input mode	7
7	1152 × 1152 operating mode input to output mapping	7
8	Half micromirror width object displacement	8
9	High resolution enables smooth motion of an optics MTF limited object	9
10	On-road symbol resolution requirements	10
11	Full-motion high resolution patterns	11
12	Typical first-generation beam distribution	12
13	Typical high beam lumens distribution	12
14	Typical high beam profile	13
15	Desired illumination profile onto DMD	14
16	Relative 3D etendue: three light-emitting surface (LES) sizes compared to a 0.55-in DMD	15
17	1.0 × 0.5-mm LES coupled to DMD	15
18	FOV stretched to 30 × 10 degrees	16
19	FOV stretched to 40 × 10 degrees	16

20	High-luminance hotspot plus background illumination concept schematic	17
----	---	----

List of Tables

1	Number of on/off line pair stripes on a 1-m tall object at various resolutions and distances.....	11
2	DMD module end to end optical efficiency estimate.....	16

Trademarks

DLP is a registered trademark of Texas Instruments.
All other trademarks are the property of their respective owners.

1 Introduction

The first DLP chipset that was released and qualified for the automotive market was the DLP3030-Q1. This chipset featured a digital micromirror device (DMD) with 415,872 individually-addressable micromirrors and a DMD diagonal of 0.3 in (7.62 mm). This device was initially designed for use in head-up display applications. However, it soon became clear that there was a market need for this type of device for use in pixelated headlight applications. Consequently, the chipset and reference design were re-optimized for these new applications. As a follow-on product, TI has developed the DLP5531-Q1, to meet the demands of headlight and related applications. This paper will examine some of the unique attributes of this chipset and how it can be combined with LED and laser light sources to create compelling high-resolution headlight products.

2 DLP Products Resolution

2.1 DLP5531-Q1 chipset introduction

Texas Instruments has introduced a new automotive DLP chipset, the DLP5531-Q1. The heart of this chipset is a 0.55-in diagonal DMD designed with new advanced headlamp applications in mind. It is 3.19 times larger in active area than the first DMD designed for the automotive market – DLP3030-Q1. This larger area supports three times greater lumens (for a given illuminator source flux density) and triples achievable peak illuminance while using conventional LED light sources. The high temperature operating range has also been extended to include operation at a die temperature of 105°C. The combination of higher temperature operation and larger imager size helps support a broader headlight FOV than is possible with the previous 0.3-in diagonal DLP automotive device.

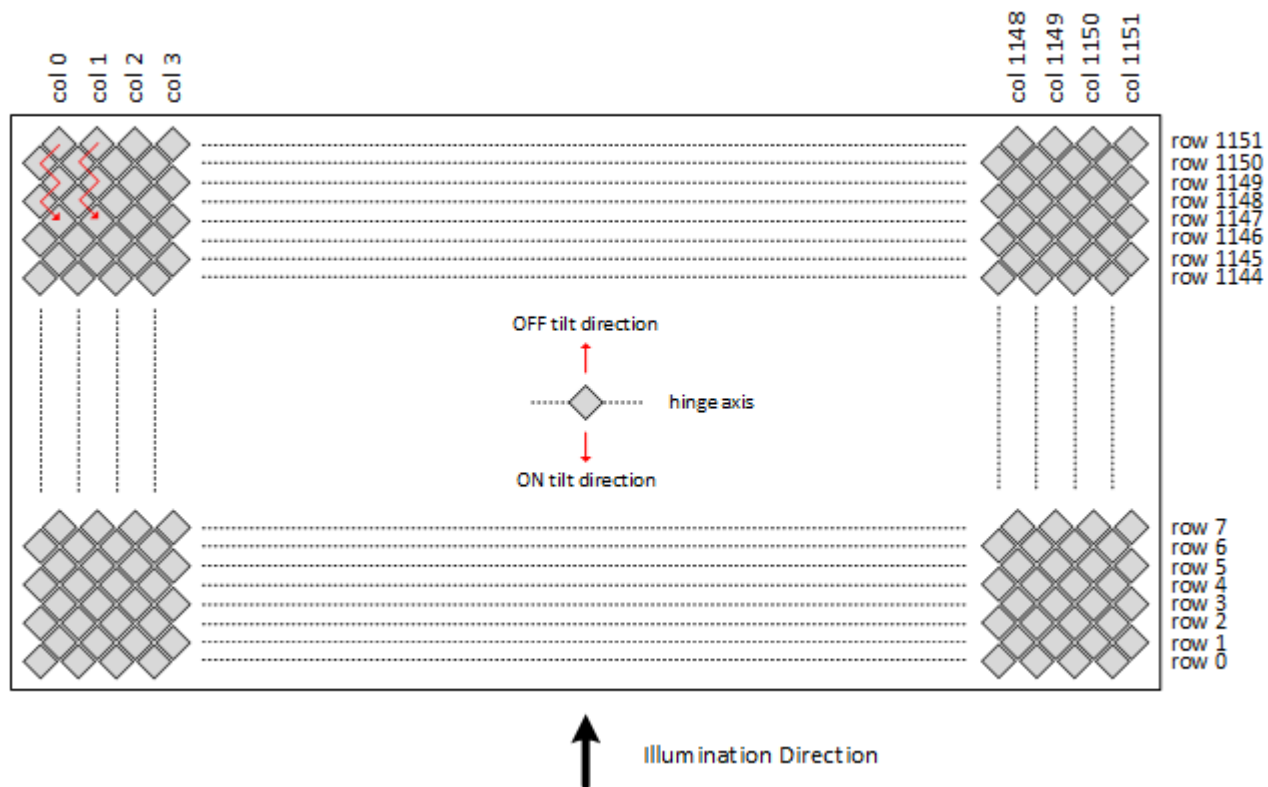

Figure 1. 1.3 million micromirrors in a diamond pixel format

The DLP5531-Q1 0.55-in DMD is a diamond micromirror device with 1152 rows (at 3.78- μm pitch) and 1152 columns (at 7.56- μm pitch) – 1,327,104 total mirrors and pixels – arranged as shown in Figure 1. The diamond arrangement results in a 2 to 1 aspect ratio, despite the 1-to-1 relationship of the row-to-column counts. This aspect ratio is wider than the 16:9 aspect ratio of the first-generation automotive 0.3-in devices to better match typical wide aspect ratios of most headlamp applications.

The DLP5531-Q1 0.55-in DMD is illuminated from the “bottom” edge, with the light source propagation direction perpendicular to the bottom long edge of the micromirror array. Diamond micromirror configuration with bottom illumination was chosen for several reasons for the headlight application. First, the diamond format provides a higher perceived resolution than an orthogonal, non-rotated micromirror, device of equal pixel count. Diamond micromirror configuration is required to support bottom illumination, and bottom illumination supports compact system packaging. This illumination direction minimizes the width of headlamp modules. The illumination path and DMD are aligned vertically instead of horizontally as with side illumination. See [Figure 2](#) for an example illustration.

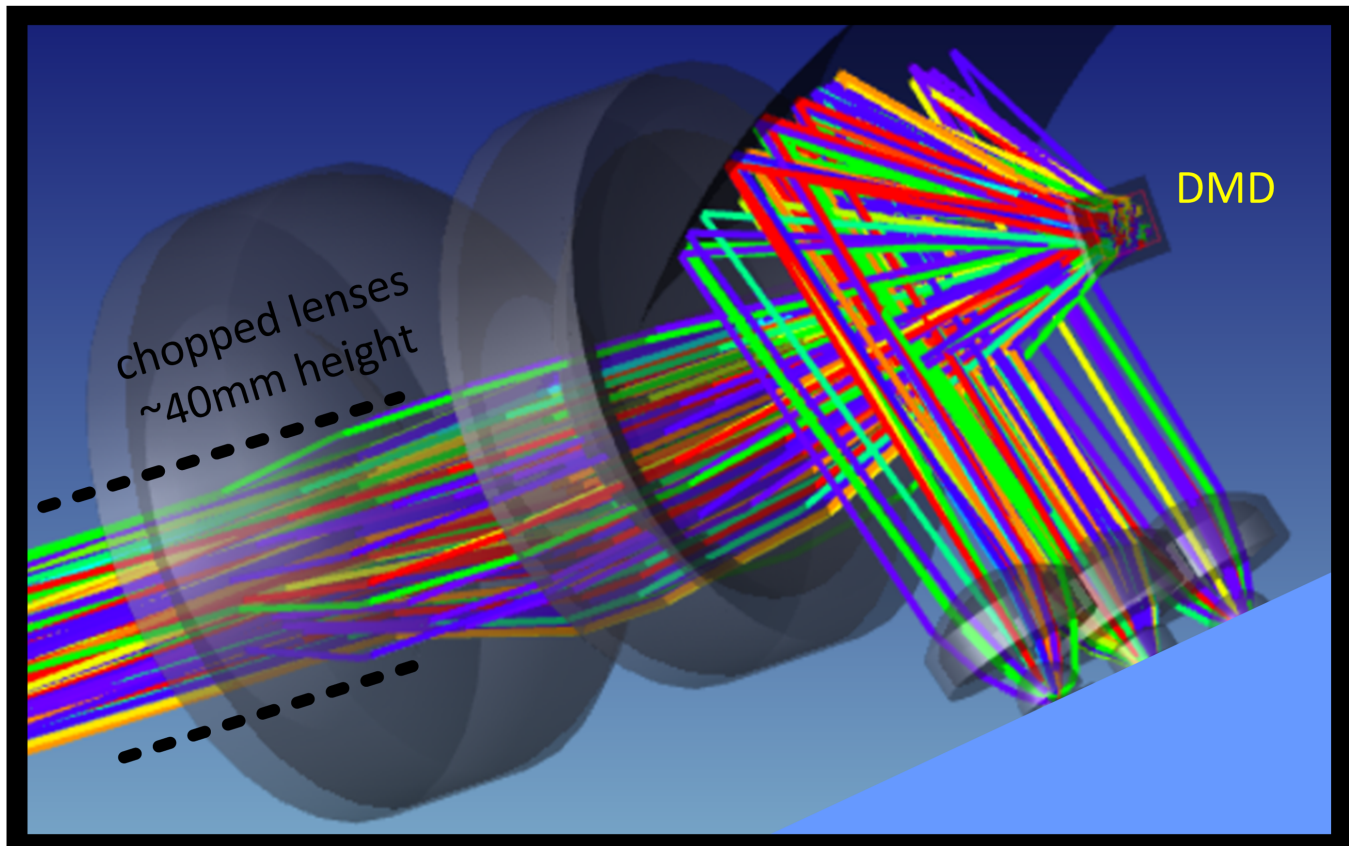

Figure 2. Bottom illumination example

Most importantly, diamond micromirror configuration and bottom illumination is the best configuration for optical power coupling efficiency. Illuminating across the long dimension of the DMD is generally better for efficient light source coupling-aids etendue matching to larger emitter area light sources. Orthogonal, non-diamond micromirror format DMDs require “corner” illumination, which negatively impacts light source coupling efficiency and increases optical design complexity. This improved etendue supports larger area light sources (more power) and/or more efficient coupling to given light source sizes.

Higher operating temperature range (up to 105°C) and a longer lifetime profile (up to 5 times the previous generation) also play a role in increasing lumens output. In practice, this improved lifetime budget may be used to increase the lumens output in high ambient temperature conditions, and also to simplify system thermal management designs and costs. This additional brightness helps support either wider FOV designs, and/or greater peak illuminance. For more information about this topic, please refer questions to a Texas Instruments application engineer.

2.2 Understanding differences between orthogonal and diamond pixel sampling formats

An orthogonal system has pixels which are sampled in a grid pattern, where row and column sample points are aligned to form straight lines. The square that surrounds each sample point represents the display device's output area for the given pixel, as illustrated in [Figure 3](#).

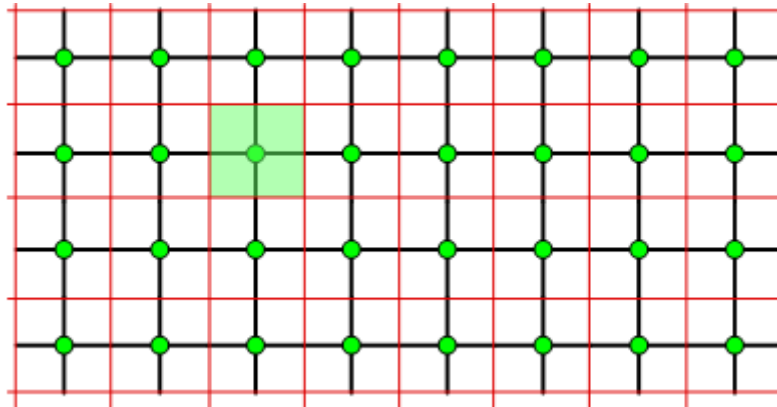

Figure 3. Orthogonal sampling and display

A diamond display system has samples centered on diamond-shaped areas (rotated squares). Image samples are offset on even vs odd lines, with samples aligned to pixel center points on a diamond pixel display device as illustrated in [Figure 4](#).

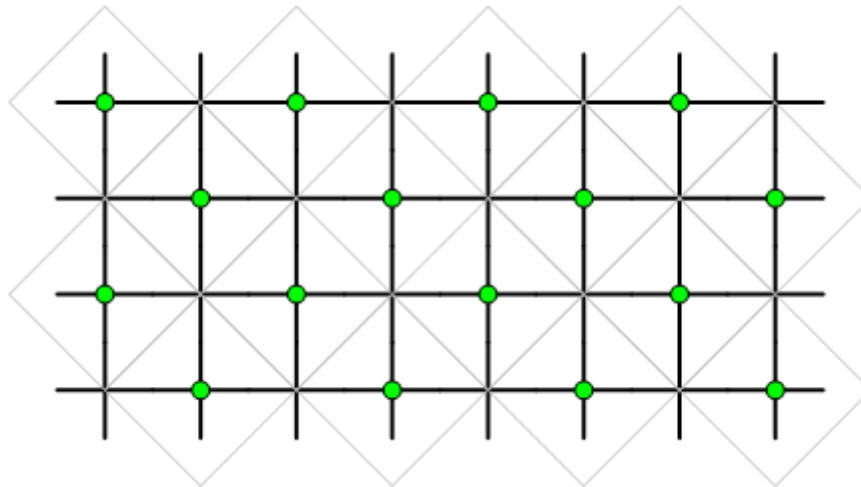

Figure 4. Diamond display lattice

For a given number of pixels, this format provides more discrete positions in both the horizontal and vertical directions than an orthogonal pixel device. The human visual system has highest acuity for horizontal and vertical structures^[1]. The diamond lattice maximizes the resolution in those directions, as illustrated in [Figure 5](#).

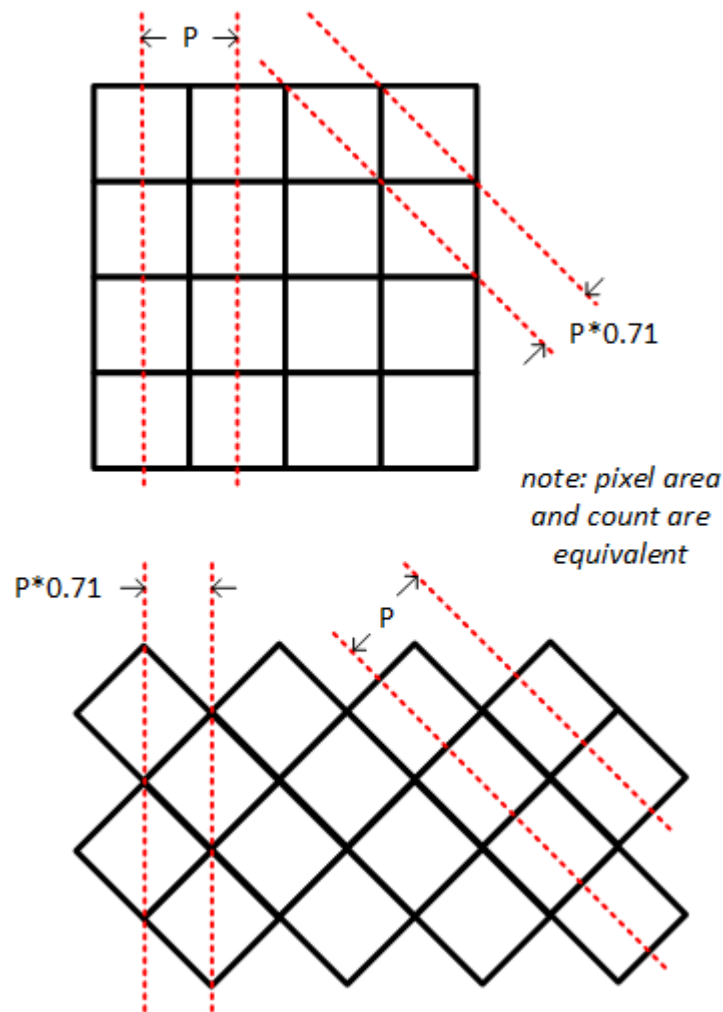

Figure 5. Relative pixel center spacing

2.3 Understanding options for supplying graphics to the DLP5531-Q1 chipset

Most graphics-processing MCUs deal with pixels using an orthogonal format assumption. What are the options for supplying graphics to the chipset for display on a diamond DMD?

The simplest option is to supply an orthogonal input to the DLPC230-Q1 controller chip (part of DLP5531-Q1 chipset) and let the chipset map to the 1152×1152 diamond array through a process of scaling and micromirror pairing. In this mode, the largest orthogonal input supported is 1152×576 – 663,552 pixels, half of the DMD's micromirror count. Smaller orthogonal inputs can be scaled up by the DLPC230-Q1 internal scaling engine to 1152×576 . In this mode, only half of the DMD's potential resolution is being utilized, but it is the simplest method for supplying graphics to the chipset.

In this 1152×576 format, each output pixel is mapped to two DMD micromirrors using line replication inside the DMD. This results in an input to output mapping as illustrated in [Figure 6](#).

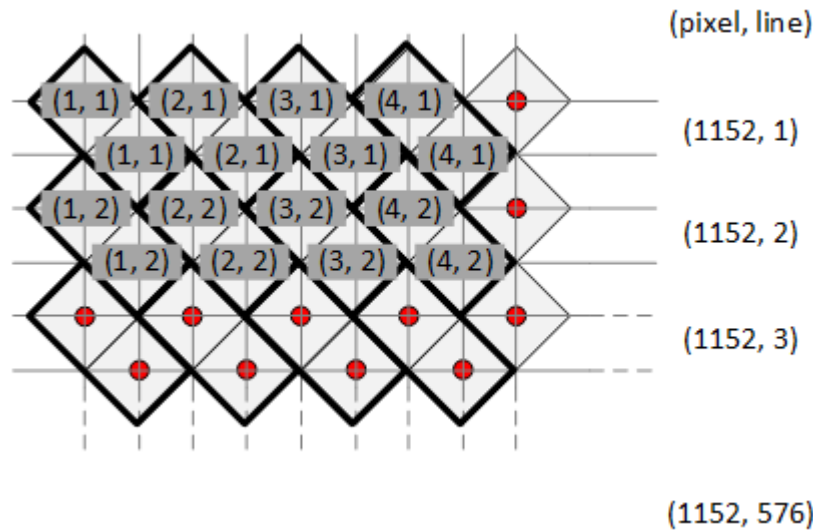

Figure 6. Orthogonal to diamond mapping using the DLPC230-Q1 controller chip 1152 x 576 input mode

The input pixels are labeled in parenthesis. For example, (1,2) is pixel one of input line number two. Notice there are two DMD micromirrors mapped to (1,2), arranged in a diagonal line.

The DLPC230-Q1 controller chip also supports a direct diamond format 1152 x 1152 input mode. All of the resolution potential provided by the 0.55-in DMD is available in this mode. For applications where a very large vertical FOV is used, this mode may be preferable to the 1152 x 576 mode.

Generally, a graphics-processing engine would render an 1152 x 1152 image in the display buffer, with the understanding that the pixels will be mapped onto DMD as shown in [Figure 7](#).

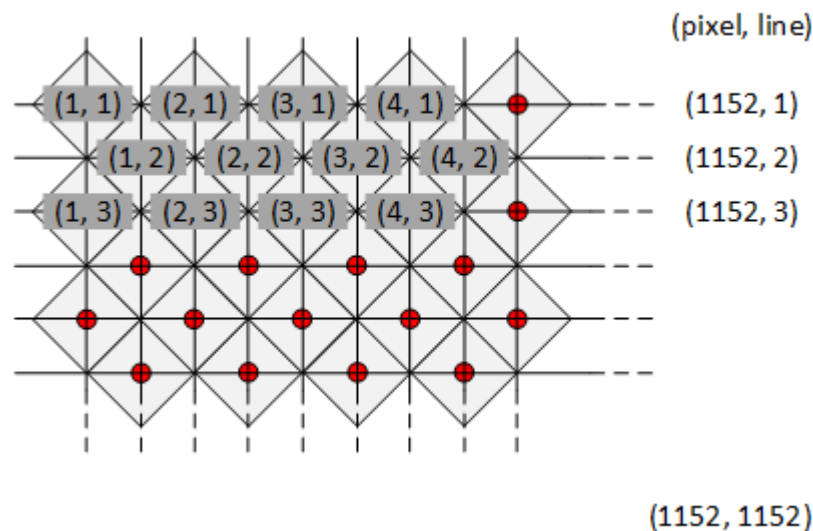

Figure 7. 1152 x 1152 operating mode input to output mapping

In this mode, every DMD micromirror maps 1-to-1 to an input pixel, without any scaling or remapping.

A simple method for processing in this mode is to generate graphics with the understanding that the DMD will perform a 2-to-1 horizontal stretch. If objects are rendered “tall and skinny” in this 1152 x 1152 format, the diamond DMD micromirror arrangement will stretch the object out to a normal aspect ratio. A half micromirror pitch step is possible in this format, as illustrated in [Figure 8](#).

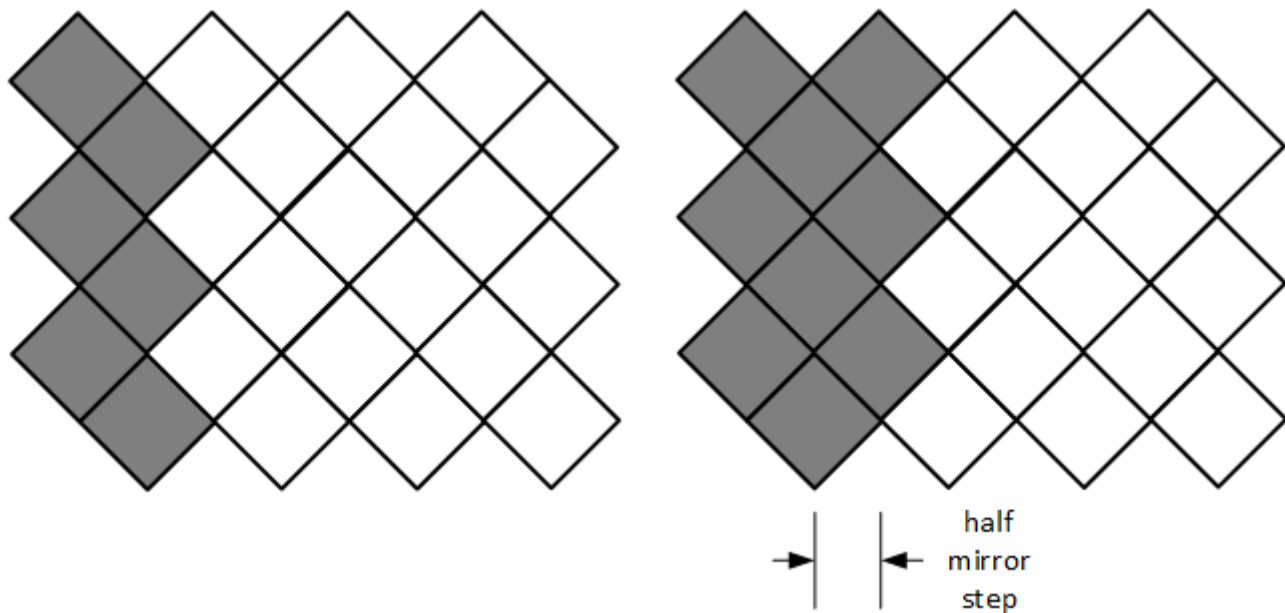

Figure 8. Half micromirror width object displacement

The edges of objects can be moved in half-DMD micromirror width steps if new columns are applied in alternating even and odd rows.

If objects are moved using the even/odd alternate row method illustrated in [Figure 8](#), there are 2,304 steps across the DMD. With attention paid to the rendering process, this method supports an object displacement resolution of 2304 × 1152 steps.

Many high-end DLP projector products also use diamond-format DMDs. In these applications, where the highest standards in image quality are basic requirements, a more complex image processing method is typically used: rendering in a super-resolution format (such as 2304 × 1152 for this example), and then using optimal spatial filtering techniques to remove high-frequency diagonal content, and finally dropping every other pixel to finish conversion to the diamond sampled format. Generally, this highest-quality super-resolution conversion technique is considered unnecessary for headlight applications (including high-quality symbols) and is not recommended. To learn more about this topic, please refer questions to a Texas Instruments application engineer.

2.4 Displacement resolution versus display resolution

What is the advantage to having a rendering and imager resolution that is higher than the line pair resolving capability of the downstream projection optics? Line pair resolving capability is typically expressed as the MTF, modulation transfer function, of the projection optics. In systems with an optics MTF resolution lower than the imager pixel count limit, the minimum achievable feature size is set by the optics. But the object position adjustment resolution (and width/height step sizes above the minimum display size) is still governed by the imager resolution, as illustrated in [Figure 9](#).

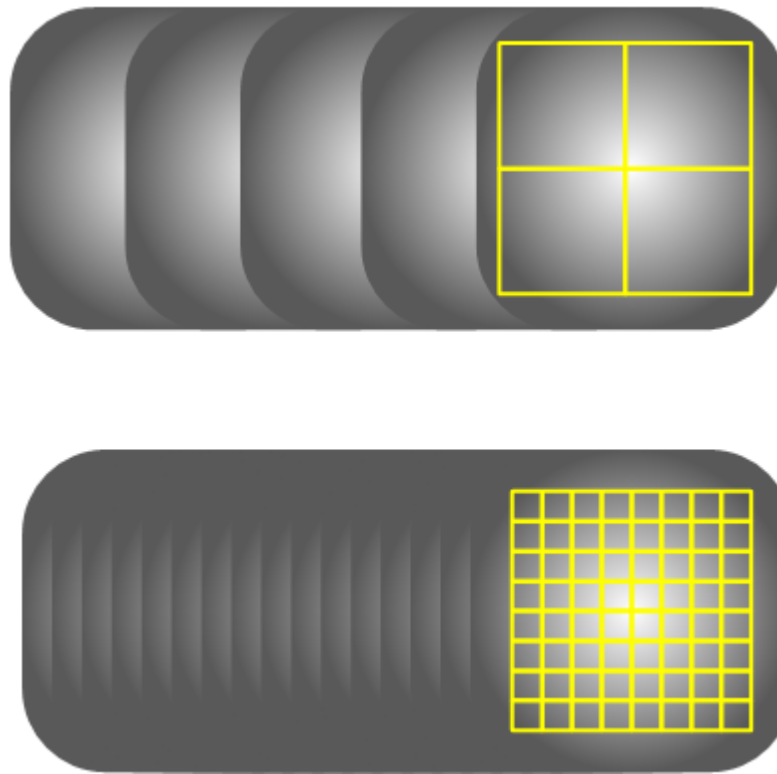

Figure 9. High resolution enables smooth motion of an optics MTF limited object

The imager resolution impacts how “smoothly” graphic objects, such as masked areas around on-coming traffic, can be moved and resized. Using lower imager and rendering resolution results in less natural motion, with the discrete steps sizes resulting in the appearance of motion judder. This judder effect is irrespective of the optical blurring due to limited MTF of projection lens.

2.5 Is 1.3 million pixels too many?

What applications require 700,000 or over 1 million pixels? On the surface, this amount of resolution seems like overkill. But in practice, it is not. To illustrate this point, let’s examine one example application: On-road augmented reality (AR)-style symbol projection.

For image projection on a vertical surface (such as a wall or garage door), resolution as low as 0.1 or 0.05 degrees per pixel is sufficient to create an interesting graphic symbol. Many demonstrations of these “on-wall” symbol projections exist in previous papers and conferences to prove this point.

But what if the desire is to not display images on a wall, but rather to make the symbols appear to lie on the road surface, as if the symbol is painted on the road? Refer to the Mercedes-Benz Innovations website for an excellent illustration of this concept [2].

For an image to appear to be part of the road, one of the requirements is restricting the longitudinal length of the symbol on the road surface to some reasonable limit, say 2 to 3 m in length. Otherwise, the “augmented reality” effect begins to get lost. When the longitudinal length of the symbol is reduced, the vertical height of the symbol in angle space is reduced, which reduces the number of imager lines available to make the symbol. For example, when the imager maximum FOV is 7 degrees or more, the portion of the imager used for the symbol can be quite small in relation to the full FOV. The illustration in [Figure 10](#) shows a 2-meter tall symbol at a relatively short distance of 10 m. The resulting height of the symbol in angle space is a mere 0.6 degrees. If the total vertical FOV is 7 degrees, this means the symbol must be constructed from only ~8-10% of the available image vertical pixel lines. This 8-10% rapidly gets worse if the distance from the car is increased or the full FOV is increased.

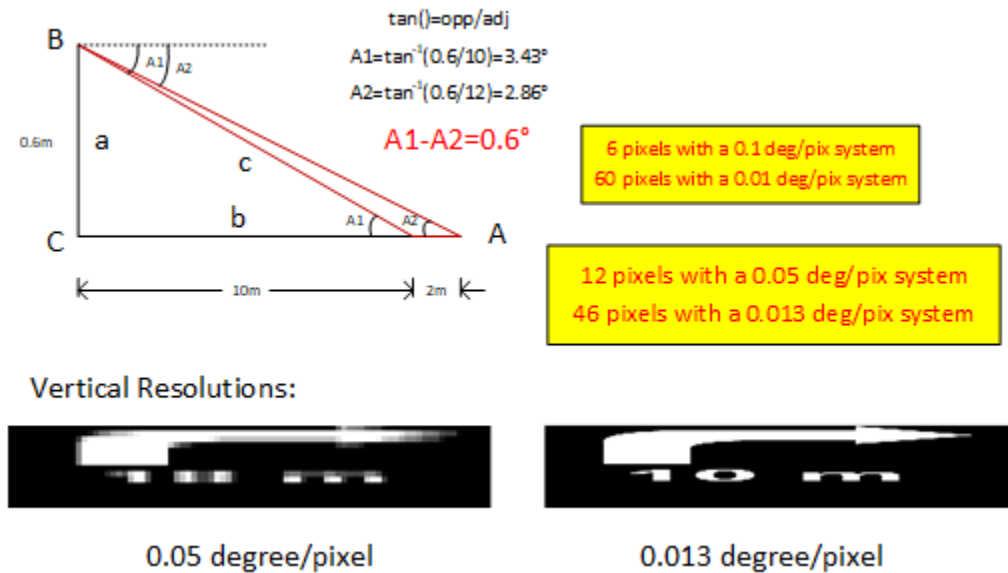

Figure 10. On-road symbol resolution requirements

The example shown in [Figure 10](#) illustrates respectable results with 0.013 degrees per pixel, but less-than-satisfactory results with 0.05 degrees per pixel. With just 0.05 degrees per pixel available, a taller symbol that covers several more meters of longitudinal road surface would be required, which does not fit the “augmented reality” rubric.

For a system using a DLP5531-Q1 0.55-in DMD operated in 1152 × 576 mode, and a 7.5 degree full vertical FOV, the resulting vertical resolution is 0.013 degrees per pixel. For vertical FOV sizes significantly greater than 7.5 degrees, the 1152 × 1152 operating mode of the DMD is available and can be used to double the effective vertical line resolution to maintain this level of performance. So, even if DMD is used for entire traditional high beam FOV plus symbol area, the 0.55-in DMD has the resolution required for on-road augmented reality symbols.

2.6 Applications using high resolution at longer ranges

It is clear high resolution is necessary for AR symbols in the near-field, but what about longer distances? What unique functionalities are enabled by high resolution? Are these new functions valuable enough to justify the extra cost of higher resolution projection optics?

Marking hazardous objects at long ranges is one such function. When a vehicle’s driver assistance system determines a hazard, such as a pedestrian or an animal is on or near the road at some distance in front of the vehicle, the system can command that pixelated headlight to place a spotlight on the object. High resolution capabilities will help provide greater precision to this marking function. But can high resolution also be used to do other things, such as increase an object’s conspicuity [3], break perceptual tunneling, or provide direct attention guidance? Or in the case of a deer, create a useful flight response [4]?

Simply using a marking light on an object will increase the object’s visibility, and clearly flashing that light can increase conspicuity further. But can high-contrast spatial patterns be used to involuntarily capture the driver’s attention? With sufficient resolution to place patterns on an object, the next potential improvement is to create motion within the patterns. Looming and abrupt onset of objects have been shown to capture attention [5]. Can a high resolution headlight create moving or looming patterns (such as swirling lines, moving arrows on road surface tracking the path to the object) that shorten a driver’s detection and reaction time in situations the driver assistance system has determined are dangerous?

First, sufficient resolution is needed to apply a pattern on objects at longer distances. [Table 1](#) shows the relationship between resolution and pattern capability at distances.

Table 1. Number of on/off line pair stripes on a 1-m tall object at various resolutions and distances

number of stripes on 1-m tall object		degree / pixel			
		0.2	0.1	0.05	0.02
distance (m)	25	5	11	22	57
	50	2	5	11	28
	100	1	2	5	14
	150	0	1	3	9

At typical highway speeds, the 100-to-150-m range is the zone where improving driver reaction would be most beneficial (at less than 100 m and highway speeds, mechanical braking times make collisions likely regardless of driver reaction time). This is also where the difference between 0.1 and 0.02 degrees per pixel is significant. With only 0.1 degree per pixel of resolution available, only a single on/off line pair can be placed on a 1-meter tall object, whereas a 0.02 degree/pixel system can place nine.

Are there certain patterns and pattern motion that are more useful than others? Can pattern motion on road surface illicit useful flight responses from wild animals on road?

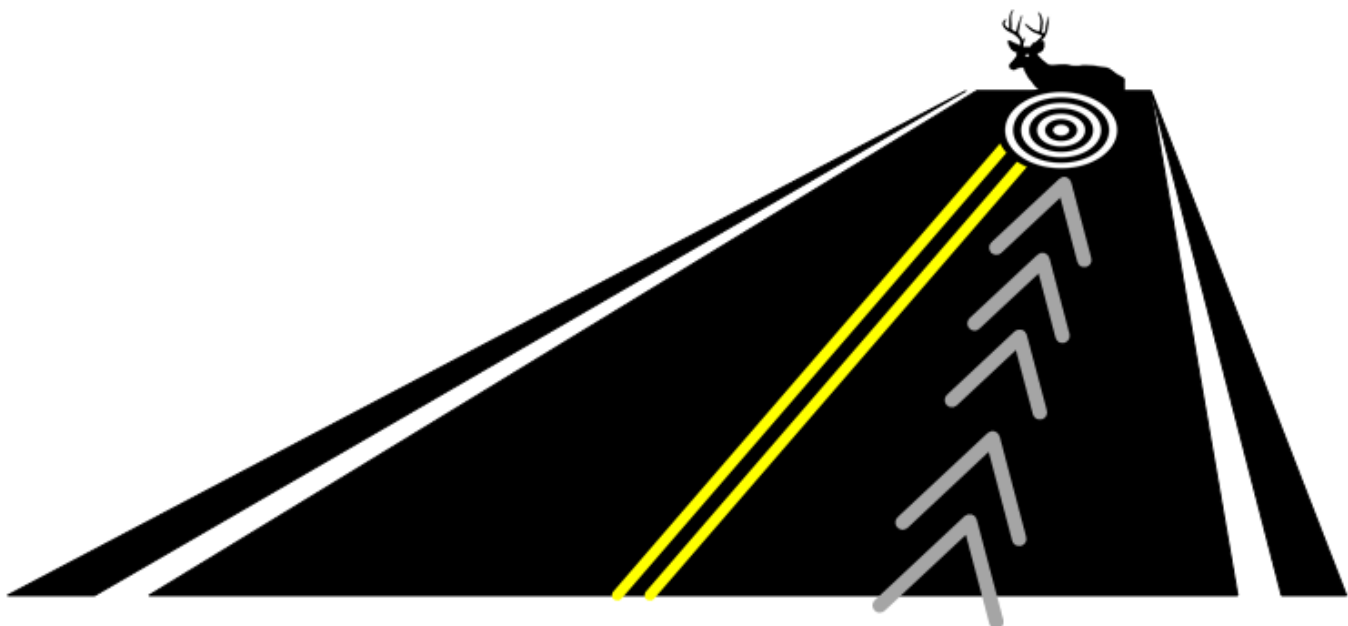

Figure 11. Full-motion high resolution patterns

What sequences of patterns work best? These are all areas where further academic and industry research is warranted, now that high resolution headlights are no longer science fiction, but included in real cars on the road.

3 High luminance concept for full FOV with high efficiency

Many first-generation DLP headlight products chipsets for headlights were designed to serve a sub-section of the traditional high- and low-beam areas of the FOV, as shown in Figure 12.

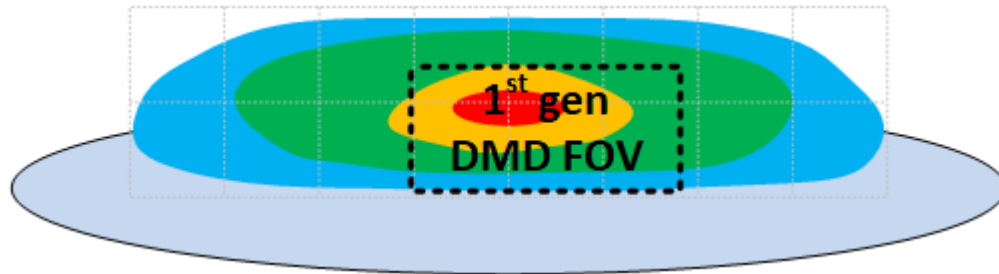

Figure 12. Typical first-generation beam distribution

The reasons for applying the DMD to this sub-portion of the full FOV are straightforward:

1. High luminous flux LEDs are used to illuminate the DMD,
2. These LEDs typically exhibit a relatively flat light distribution, and
3. the required headlight light distribution is not a flat distribution.

The desired illumination distribution has a disproportionately large amount of the total lumens in the center 10% of the image, as shown in Figure 13.

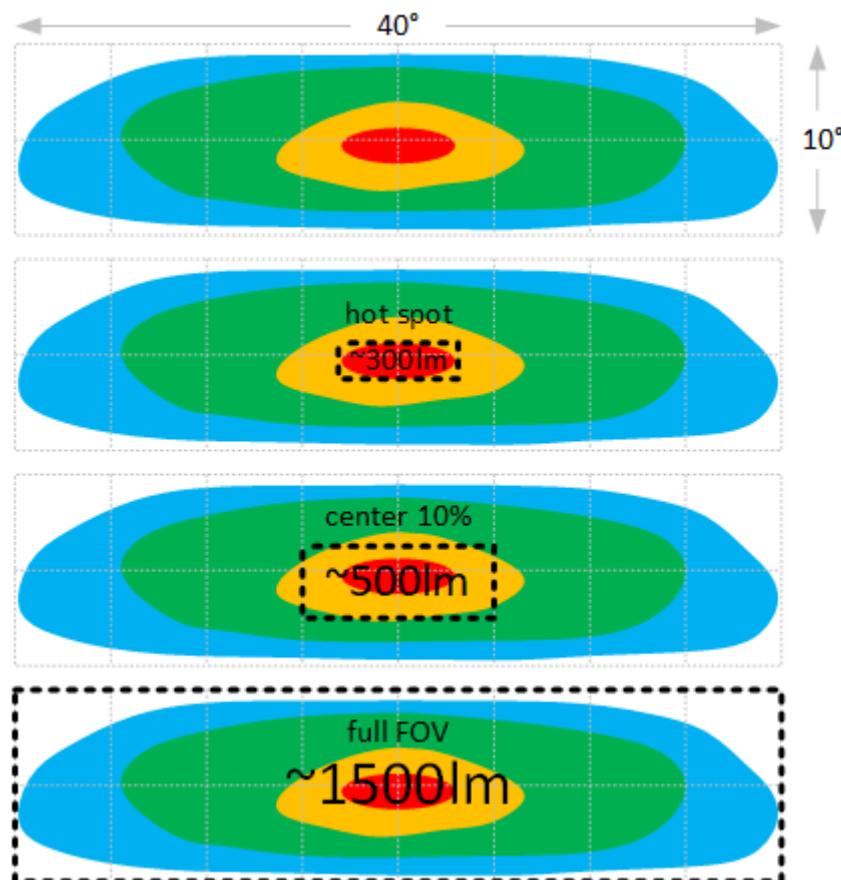

Figure 13. Typical high beam lumens distribution

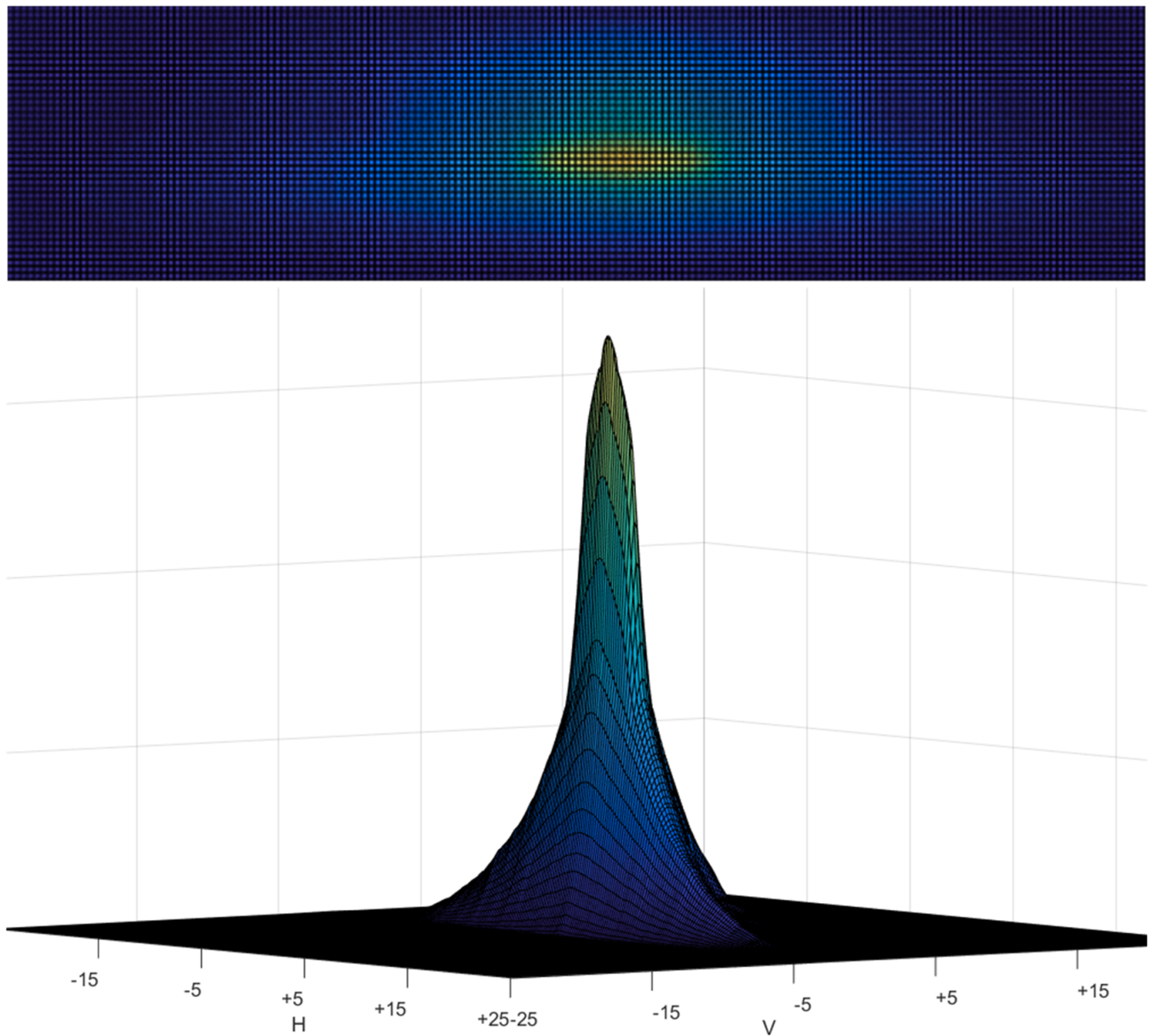

Figure 14. Typical high beam profile

Because the DMD headlight is an imaging system in addition to an illumination system, the options to boost on-center brightness using the optical design of the projection lens (after the DMD) are limited. A 1-to-1 relationship must be maintained between DMD micromirrors and spots in the far field and some minimum level of focus quality must be maintained. Consequently, many of the interesting techniques of non-imaging optics are not applicable to the projection lens design. This pushes the requirement for creating the hot spot back onto the illumination optics design - before the DMD.

It has been demonstrated that a high-current LED's typical 220 cd/mm² peak luminance is sufficient for creating hot spots when the FOV is restricted. For example, TI's first prototype using 220 cd/mm² LEDs had an on-center peak illuminance of 140 lux at 25 m with a covered FOV of 14 × 7 degrees. If the projection lens is changed to cover a larger FOV, the on-center hot spot illuminance would be expected to go down by the ratio of the new FOV size in degrees squared compared to this 14 × 7 case (14 × 7 is 98 degrees squared). If the size of this FOV is increased to 20 × 10, the on-center peak lux would be expected to go down to 68 lux. For a 30 × 10 degree FOV, the result is an even more modest 45 lux, and so on for the full 40 × 10 case – approximately 1/4th lux of the 14 × 7 case.

Note: For some applications, this reduced on-center brightness is acceptable. For example, if an auxiliary boost module is used to enhance the “hot spot” brightness (the boost module could be another DLP Products-enabled module of reduced FOV or a small LED matrix), or if the module is principally used for projection of on-road symbols. But if the desire is to use the DLP Products module as the only light module in the headlight (besides a near-field spread light), this limited on-center hotspot brightness would be unacceptable.

To maintain high on-center brightness while increasing the FOV, the illumination source luminance for the on-center portion of the FOV must increase in proportion to the FOV relative area increase. Otherwise, the hot spot brightness will fall in inverse proportion to the area increase of the total FOV covered by the DMD. Effectively, the area dilution of the brightness from increasing the FOV must be counteracted by an increase in source luminance (for the center hot spot section only). For example: to go from 14×7 to 30×10 FOV, a $\sim 3x$ increase in luminance of the illumination light source is required to maintain the same on-center peak brightness.

However, if the entire light source luminance is tripled, total lumens and electrical power will also triple. This power increase is unacceptable, assuming such a high power density light source is even available. The DMD in this case must be used to subtract light from areas outside the hotspot to create a head light profile, leading to unacceptably low system efficiency.

What is needed to solve this dilemma is a light source that in effect has very high luminance in the center section, with a sharp roll-off to a relatively lower luminance in outer section of the light source. In addition, this entire light source must fit within the etendue of the DMD. This combination of the requirement to fit into etendue of DMD and also have a very high ratio of “on-center-to-average” luminance is the main challenge to using a DMD for the full beam. The total lumens requirement is not as much of a challenge.

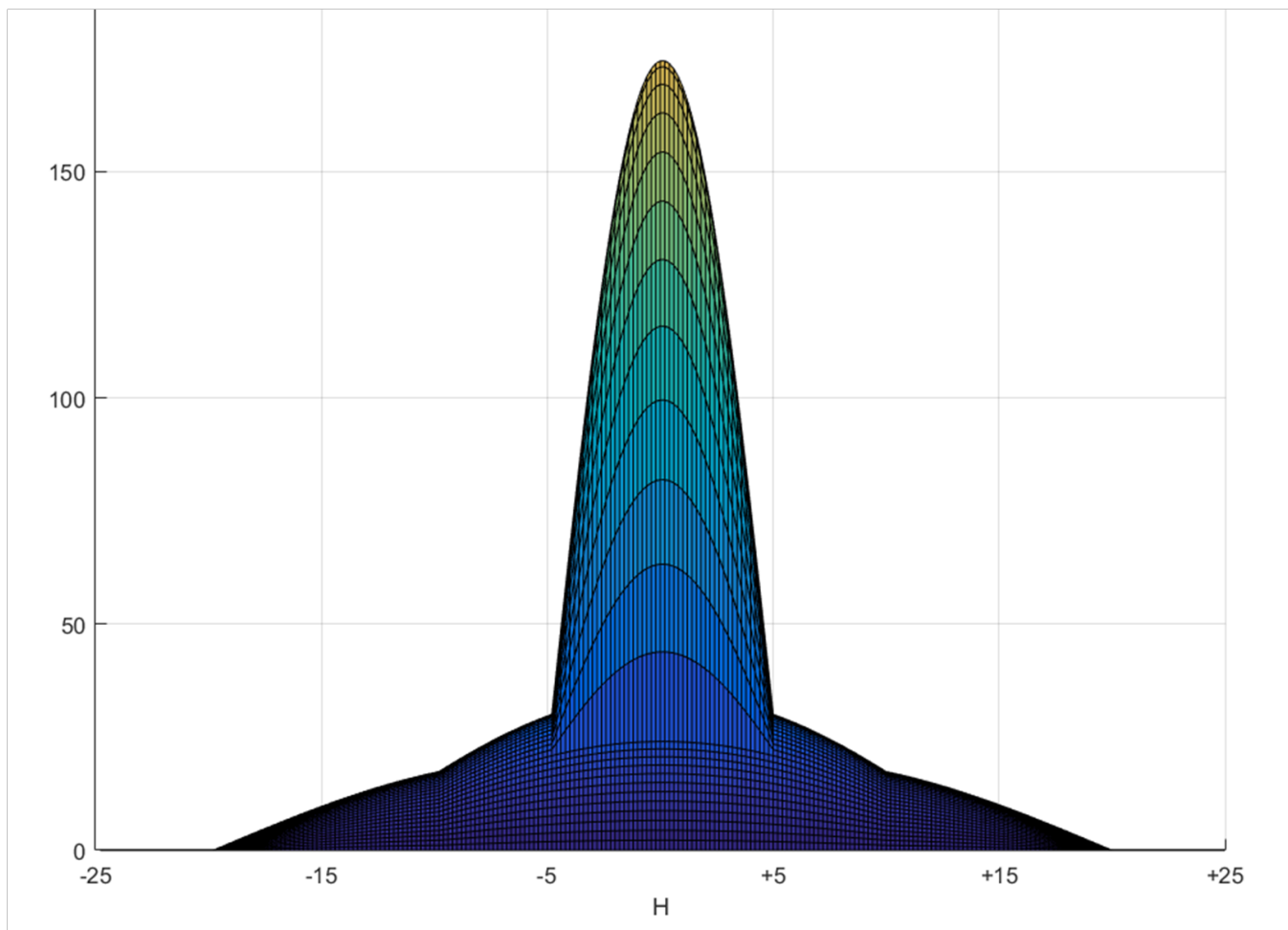

Figure 15. Desired illumination profile onto DMD

The illumination light source for the DMD must fit into the DMD's etendue, which is a function of area and acceptance angle of the DMD. The result is that Lambertian profile illumination light emitting surfaces (LES) beyond a certain size cannot be efficiently coupled to the DMD. A comparison of light emitting source area sizes to DMD relative etendue is shown in Figure 16.

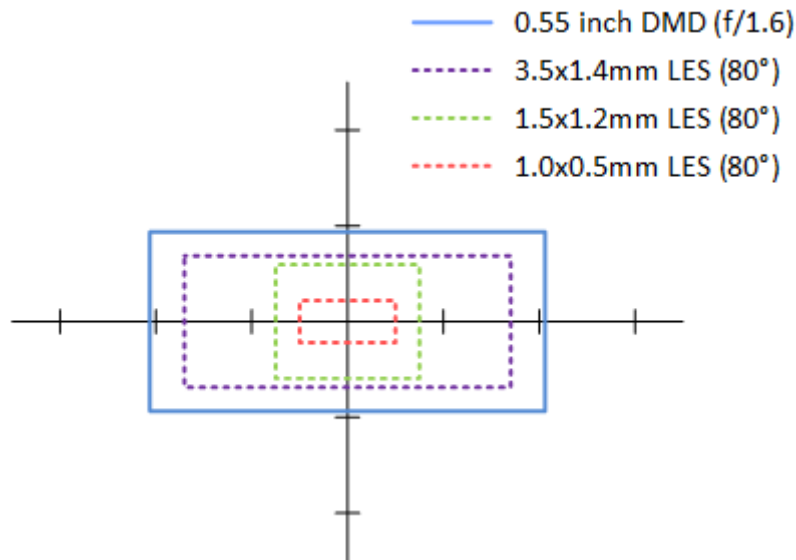

Figure 16. Relative 3D etendue: three light-emitting surface (LES) sizes compared to a 0.55-in DMD

The 3.5 × 1.4-mm source size corresponds to the largest Lambertian light-emitting surface size that can couple efficiently to the 0.55-in DMD with margin and typical DLP Products optical design assumptions. (Note: the etendue margin as visualized above is the amount, based on experience, required to enable high contrast.) With a source larger than this size, only the center 3.5 × 1.4-mm section would couple light to the DMD, and the remainder of the light would be wasted.

A smaller light-emitting surface could be imaged to a smaller section of the DMD, as long as the same etendue guidelines are met. A 1 × 0.5-mm light-emitting source size would couple to a small sub-section of the DMD as illustrated in Figure 17.

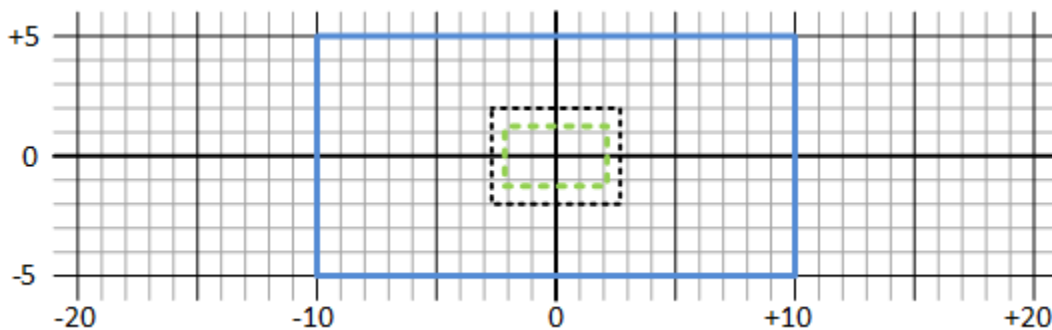

Figure 17. 1.0 × 0.5-mm LES coupled to DMD

The DMD etendue outline (blue) in Figure 17 is shown mapped onto a 20 × 10 degree projected FOV. This area represents the total FOV covered by the DMD. The black dotted line represents the smallest portion of the DMD which can easily be efficiently coupled to a single 1.0 × 0.5-mm light-emitting surface (with similar margin as the 3.4 × 1.4-mm case above). If a design was optimized to couple light from a 1.0 × 0.5-mm source, this is the area in angle space that would be illuminated in a 20 × 10 degree system.

If the DMD is imaged across an entire 30 × 10 FOV (a stretch of 1.33 to 1), the portion of the DMD that has etendue that matches a 1 × 0.5-mm source is roughly 8 × 4 degrees when projected on the road.

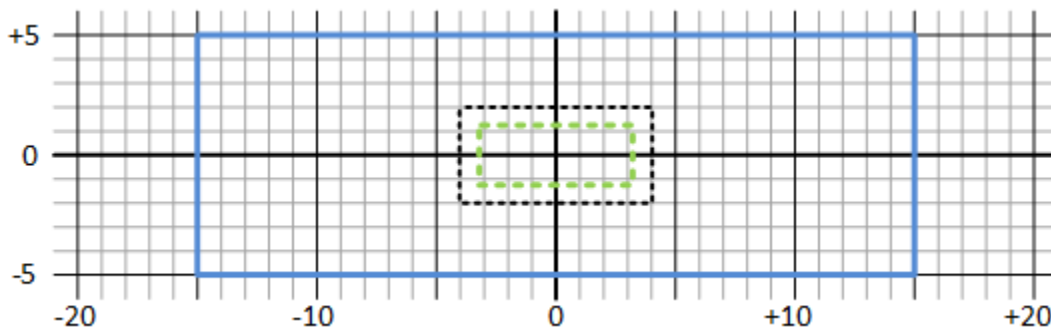

Figure 18. FOV stretched to 30 × 10 degrees

For a 40 × 10 degree FOV, the 1 × 0.5-mm source etendue matching area is approximately 10 × 4 degrees, as illustrated in Figure 19.

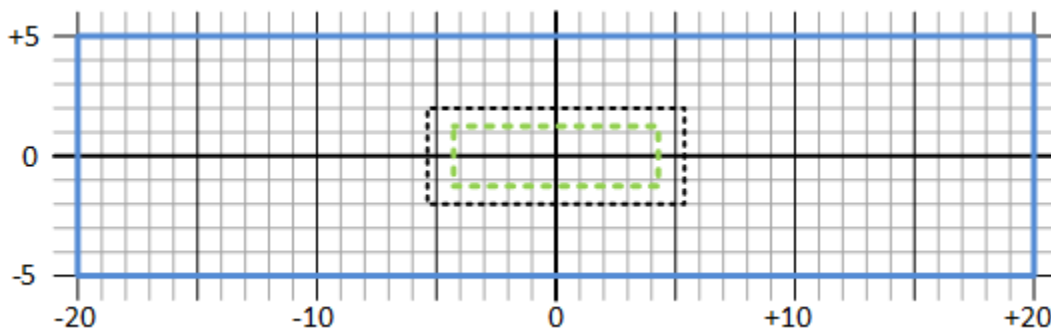

Figure 19. FOV stretched to 40 × 10 degrees

This illuminated area is very close in size to the hot spot shown in Figure 13. If this 1.0 × 0.5mm input light-emitting surface has a luminance of 220 cd/mm², the expected luminance in the peak center section would drop from the TI reference design levels by a factor of 3 to 4 (30 × 10, 40 × 10 cases respectively).

To maintain the necessary on-center hot-spot brightness, you need a light source that has 3- to- 4 times this source luminance level to overcome this one-third- to- one-fourth drop in brightness due to expansion of the total FOV in relation to the DMD. With a light source with that level of luminance, it should be possible to maintain similar peak lux as our 14 × 7-degree reference design while expanding the FOV to 30 × 10 or 40 × 10 respectively.

The lumens required from this 1.0 × 0.5-mm light-emitting surface area source can also be calculated. From Figure 12, the approximate output luminous flux in the center region is around 500 lumens. The end-to-end optical efficiency of the DMD system can be estimated as follows:

Table 2. DMD module end to end optical efficiency estimate

	illumination path	DMD	Projection lens	Total	Cover	To road...
High	0.85	0.66	0.85	0.48	0.88	0.42
Low	0.70	0.66	0.85	0.39	0.88	0.35

For a 0.4-efficiency assumption, the total input lumens required at the input is ~1250 lumens. This general lumens level from a small light emitting surface is becoming realistic. Refer to K. Bando: "New Generation LEDs and LD for Automotive lighting", ISAL, Darmstadt, Germany, 2017 for a recent example [6]. Note that some of the background illuminator light generally will also illuminate the hotspot, reducing lumens requirements of the hot spot illuminator to some degree.

Once the on-center hotspot is supplied with sufficient photons by a single high luminance white laser module, the remainder of the DMD can be illuminated with other more moderate luminance light sources. Conceptually, the extremely high luminance light from a white laser diode module is folded into the light path of another illumination light bundle, as illustrated in schematic form in [Figure 20](#).

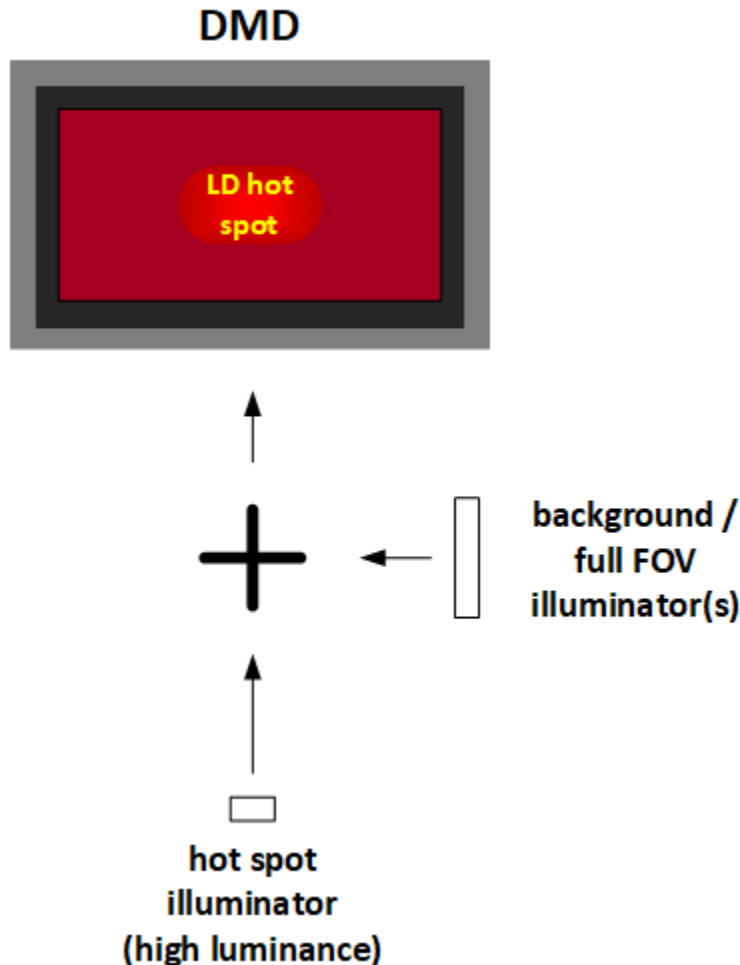

Figure 20. High-luminance hotspot plus background illumination concept schematic

Ideally, the background illuminator would be based on LED technology to take advantage of the better luminous efficacy of LEDs compared to lasers (approximately 2x better than lasers with today's best techniques). Implementation concepts using micro lens arrays, light pipes and/or path folding are under consideration. Mechanical packaging presents a challenge for some of these concepts, but there is ample room for innovation and multiple solutions to this design challenge. The smallest optical packaging solutions may drive a need for background and hotspot illuminators co-packaged on a common backplane, for example.

This combination of a small light-emitting surface size plus relatively high lumens of the hot spot illuminator is a key requirement to enable hot spot formation on the DLP5531-Q1 0.55-in DMD. A 1 x 0.5-mm light-emitting surface size serendipitously matches the maximum size light source that can be coupled to the center ~10% of the DMD, which maps to the hot spot zone of the head lamp beam. A Lambertian source area any larger than this is too large to couple to the etendue of the hotspot zone on the DMD. The light source must produce sufficient lumens to meet illuminance requirements in the hot spot zone. Both high lumens and a small light-emitting surface size are required for the hot spot illumination. For the remaining task of filling the rest of the DMD's etendue with background light, LED technology is preferred for reasons of efficiency. Properly optimizing illuminator packaging and optics designs is a remaining challenge with many options to explore.

4 Conclusion

In this paper, we introduced the newest DLP Products automotive chipset, the DLP5531-Q1, and examined specific resolution capabilities and applications enabled by this advance in headlight resolution. We revealed why megapixel resolutions are not only useful, but a fundamental requirement for many emerging headlight concepts. Exciting new possible long-range applications are presented as areas for further research, enabled exclusively by megapixel resolutions. Finally, we also propose high-luminance illumination concepts that show promise for achieving full adaptive-beam FOV requirements.

5 Acknowledgement

The authors acknowledge the contribution of their colleagues to this work: John Ferri, Greg Pettitt, Gavin Perella, Steve Shaw, and Vikrant Bhakta.

6 References

- (1) Scott J. Daly: "Visible differences predictor: an algorithm for the assessment of image fidelity," Proc. SPIE 1666, Human Vision, Visual Processing and Digital Display III, 1992.
- (2) "Digital Light. Future headlamp technology in HD quality.", Retrieved 7/2018 from Mercedes Benz website, <https://www.mercedes-benz.com/en/mercedes-benz/innovation/digital-light-headlamps-in-hd-quality/>
- (3) P. Gershon, D. Shinar: "Increasing motorcycles attention and search conspicuity by using Alternating-Blinking Lights System (ABLS)", Accident Analysis and Prevention, Volume:50, Association for the Advancement of Automotive Medicine, January 2013.
- (4) B. Blackwell, T. Seamans: "Enhancing the Perceived Threat of Vehicle Approach to Deer", The Journal of Wildlife Management, Volume:73: 128-135, 2008.
- (5) S. Franconeri, D. Simons: "Moving and looming stimuli capture attention", Perception & Psychophysics, Volume:65, Issue:7, Psychonomic Society, 2003.
- (6) K. Bando: "New Generation LEDs and LD for Automotive lighting", ISAL, Darmstadt, Germany, 2017.

7 Glossary

AR: Augmented Reality

ASIC: Application Specific Integrated Circuit

DMD: Digital Micromirror Device

FOV: Field of View

HUD: Head-up Display

LD: Laser Diode

LED: Light-Emitting Diode

LES: Light-Emitting Surface

MCU: Micro-Controller Unit

MTF: Modulation Transfer Function

IMPORTANT NOTICE AND DISCLAIMER

TI PROVIDES TECHNICAL AND RELIABILITY DATA (INCLUDING DATASHEETS), DESIGN RESOURCES (INCLUDING REFERENCE DESIGNS), APPLICATION OR OTHER DESIGN ADVICE, WEB TOOLS, SAFETY INFORMATION, AND OTHER RESOURCES "AS IS" AND WITH ALL FAULTS, AND DISCLAIMS ALL WARRANTIES, EXPRESS AND IMPLIED, INCLUDING WITHOUT LIMITATION ANY IMPLIED WARRANTIES OF MERCHANTABILITY, FITNESS FOR A PARTICULAR PURPOSE OR NON-INFRINGEMENT OF THIRD PARTY INTELLECTUAL PROPERTY RIGHTS.

These resources are intended for skilled developers designing with TI products. You are solely responsible for (1) selecting the appropriate TI products for your application, (2) designing, validating and testing your application, and (3) ensuring your application meets applicable standards, and any other safety, security, or other requirements. These resources are subject to change without notice. TI grants you permission to use these resources only for development of an application that uses the TI products described in the resource. Other reproduction and display of these resources is prohibited. No license is granted to any other TI intellectual property right or to any third party intellectual property right. TI disclaims responsibility for, and you will fully indemnify TI and its representatives against, any claims, damages, costs, losses, and liabilities arising out of your use of these resources.

TI's products are provided subject to TI's Terms of Sale (www.ti.com/legal/termsofsale.html) or other applicable terms available either on ti.com or provided in conjunction with such TI products. TI's provision of these resources does not expand or otherwise alter TI's applicable warranties or warranty disclaimers for TI products.

Mailing Address: Texas Instruments, Post Office Box 655303, Dallas, Texas 75265
Copyright © 2019, Texas Instruments Incorporated