

Getting Started With TI DLP® Display Technology



Juan Alvarez and Jesse Richuso

ABSTRACT

This application note is a comprehensive quick guide to find important resources for DLP® display products intended for industrial, enterprise, or personal electronics applications. This document serves as a starting guide for DLP chipset selection, evaluation, design, and manufacturing. You can benefit from this document regardless of your experience level and involvement with a DLP display system. You can send feedback or comments on this document using [TI DLP Products E2E support forum](#).

The maturity of the design and manufacturing ecosystem for DLP display technology allows developers to take display application concepts to production quickly as illustrated below.

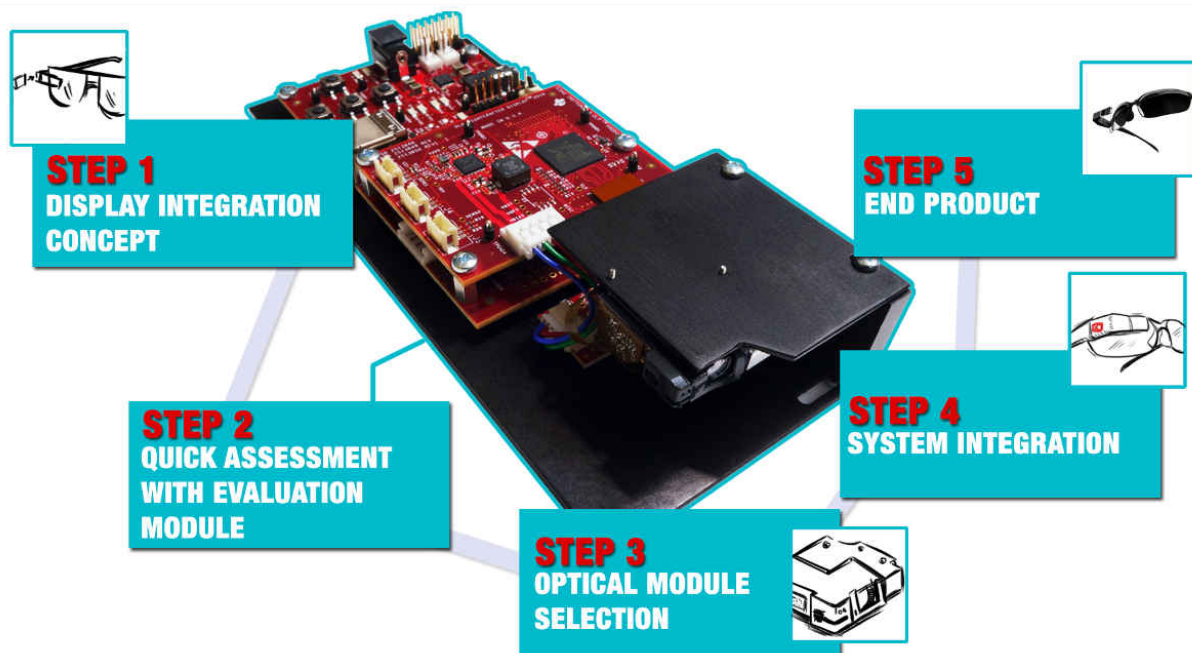

Interested in DLP technology outside of industrial, enterprise, and personal electronics display applications? [Click here](#) for DLP automotive applications and [click here](#) for Light Control applications using DLP technology, such as 3D print, 3D machine vision, and 3D scanning.

Table of Contents

1 Introduction	3
2 DLP Display Projection Benefits	4
3 What is DLP Technology?	8
4 The DLP Display System	9
4.1 Component Part Number Identification.....	9
4.2 Electronics Hardware.....	10
4.3 Optics.....	12
5 Selecting the Correct DLP Display Chipset	15
5.1 Brightness.....	15
5.2 Resolution.....	16
5.3 Size.....	16
6 How to Evaluate Selected DLP Display Chipset	17
7 Selecting the Correct Optical Engine	18
7.1 Optical Module Selection.....	18
7.2 Optical Module Sourcing.....	18
8 DLP Products Supply Chain	19
9 Development and Manufacturing	19
9.1 Electrical Considerations.....	19
9.2 Software Considerations.....	19
9.3 Optical Considerations.....	19
9.4 Mechanical Considerations.....	20
9.5 Thermal Considerations.....	20
9.6 Manufacturing Considerations.....	20
10 Online Resources	21
10.1 DLP Chipset Information.....	21
11 Common Display and Projection Terminology	22
12 References	24
13 Revision History	24

List of Figures

Figure 3-1. Digital Micromirror Device.....	8
Figure 4-1. Typical DLP Display Block Diagram.....	9
Figure 4-2. DLP .2 nHD (DLP2000) Chipset Evaluation Module (EVM) Electronics.....	10
Figure 4-3. Example of a Small Board Design.....	12
Figure 4-4. DLP Pico .23 1080p (DLP230NP) Display Optical Engine.....	13
Figure 4-5. .2 WVGA (DLP2010) Optical Module Example.....	13
Figure 5-1. Minimum Target Resolution.....	16
Figure 6-1. .33 1080p (DLP3310) EVM PC Tool DLP IntelliBright Algorithms Screen.....	17
Figure 11-1. Vertical Keystone Correction.....	22
Figure 11-2. Offset Effect on Projected Image.....	23
Figure 11-3. Throw Ratio Diagram.....	23

List of Tables

Table 1-1. Prioritizing Assistance.....	3
Table 2-1. DLP Projection Benefits.....	4
Table 2-2. DLP Technology Benefits.....	5
Table 2-3. DLP Projection Benefits.....	6
Table 2-4. DLP Technology Benefits.....	7
Table 4-1. DLP Display Chipset Nomenclature.....	9
Table 4-2. Electronic Components.....	11
Table 4-3. Optical Components Included in an Optical Module.....	14
Table 5-1. Resources Available.....	15
Table 7-1. Example Optical Module Specification Table.....	18
Table 10-1. Resources Available.....	21
Table 10-2. Popular Resources.....	21
Table 11-1. Common Display and Projection Terminology.....	22

Trademarks

LightCrafter™, DLP IntelliBright™, and DLP Composer™ are trademarks of Texas Instruments.
DLP® is a registered trademark of Texas Instruments.

All trademarks are the property of their respective owners.

1 Introduction

DLP® display products are used in a wide range of traditional accessory projectors and emerging display equipment. These include embedded projectors in smart phones and tablets, interactive surface computing, screenless and laser TVs, augmented reality glasses, digital signage, projection mapping, large venue, and cinema. DLP display technology contains two families of products, DLP Pico™ chipsets and DLP Standard chipsets. [DLP Pico chipsets](#) offer versatile display capability and can create images on virtually any surface from ultramobile devices. They are a good fit for any application requiring a display with high contrast, small size, and low power. [DLP Standard chipsets](#) enable amazing images for systems that require large screen bright displays with high resolution.

To help you navigate through this document, a [Table 1-1](#) is provided to assist in prioritizing the sections that you might be interested in.

Table 1-1. Prioritizing Assistance





I am...	Electrical Engineer	Optical Engineer	Software Engineer	Systems Engineer	Portfolio Manager
New to DLP technology	<ul style="list-style-type: none"> DLP display projection benefits What is DLP Technology? 				
Selecting a DLP chipset	<ul style="list-style-type: none"> What is the DLP display electronics system? How to select the correct DLP display chipset 	<ul style="list-style-type: none"> What is the display optics system? How to select the correct DLP display chipset 	<ul style="list-style-type: none"> What is the DLP display electronics system? How to select the correct DLP display chipset 	<ul style="list-style-type: none"> What is the DLP display electronics and optics system? How to select the correct DLP display chipset 	<ul style="list-style-type: none"> How to select the correct DLP display chipset
Evaluating a DLP chipset	<ul style="list-style-type: none"> Chipset evaluation 				
Development and Manufacturing	<ul style="list-style-type: none"> Design and Production 				

As you move along with your display application development, see the [Table 1-1](#). For a quick reference guide on DLP Pico technology, see [Getting Started with DLP Pico technology](#).

2 DLP Display Projection Benefits

Table 2-1 shows the main benefits that DLP projection enables for virtually any display application.

Table 2-1. DLP Projection Benefits

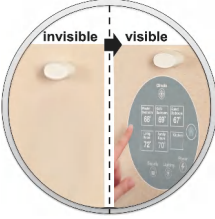
Benefit		Description
Excellent image quality		Based on the same display technology used in 9 out of 10 cinemas worldwide ¹ , the DLP chipset can enable a display that offers saturated colors and high contrast. Display system performance can vary depending on the optical engine.
High contrast ratio		The reflective technology of DLP technology allows for high contrast as off state mirrors reflect light away from the projection optics creating very black pixels on the display surface.
Free form display		Given its projection nature and high contrast ratio, one can enable a display with virtually any form factor. Black pixels will not show on the display surface (effectively providing a transparent background in those areas).
Display on virtually any surface		Projection will display on virtually any surface. Warping can be used to geometrically compensate for irregular-shaped display surfaces.
Small size, large image		The DLP technology optical architecture and pixel design allows for extremely small-form factors compared to the image displayed.
Only visible when needed		DLP projection display can be turned on and off on demand. The display disappears when it is turned off.

Customers can learn how to promote features enabled by DLP technology by visiting the [DLP Products Messaging and Icons Guidelines](#) document (requires a myTI login).

¹ Based on PMA Research

DLP technology benefits outlined by application when visiting the web sites shown in [Table 2-2](#).

Table 2-2. DLP Technology Benefits







Website	Application Examples
<p>Applications for DLP Pico chipsets</p>	<p>Pico projector, Enterprise portable projector, Laser TV <85", smart home displays, industrial displays (DLP signage, humanoids, commercial gaming), virtual reality/augmented reality glasses, smartphones and tablets (mobile accessories), and more.</p> 
<p>Applications for DLP Standard chipsets</p>	<p>Laser TV > 85", smart projector, digital signage, enterprise projector, large venue, and cinema.</p> 

Table 2-1 shows the main benefits that DLP projection enables for virtually any display application.

Table 2-3. DLP Projection Benefits

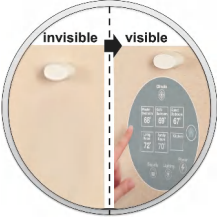

Benefit		Description
Excellent image quality		Based on the same display technology used in 9 out of 10 cinemas worldwide ² , the DLP chipset can enable a display that offers saturated colors and high contrast. Display system performance can vary depending on the optical engine.
High contrast ratio		The reflective technology of DLP technology allows for high contrast as off state mirrors reflect light away from the projection optics creating very black pixels on the display surface.
Free form display		Given its projection nature and high contrast ratio, one can enable a display with virtually any form factor. Black pixels will not show on the display surface (effectively providing a transparent background in those areas).
Display on virtually any surface		Projection will display on virtually any surface. Warping can be used to geometrically compensate for irregular-shaped display surfaces.
Small size, large image		The DLP technology optical architecture and pixel design allows for extremely small-form factors compared to the image displayed.
Only visible when needed		DLP projection display can be turned on and off on demand. The display disappears when it is turned off.

Customers can learn how to promote features enabled by DLP technology by visiting the [DLP Products Messaging and Icons Guidelines](#) document (requires a myTI login).

DLP technology benefits outlined by application when visiting the web sites shown in [Table 2-2](#).

² Based on PMA Research

Table 2-4. DLP Technology Benefits

Website	Application Examples
<p>Applications for DLP Pico chipsets</p>	<p>Pico projector, Enterprise portable projector, Laser TV <85", smart home displays, industrial displays (DLP signage, humanoids, commercial gaming), virtual reality/augmented reality glasses, smartphones and tablets (mobile accessories), and more.</p> 
<p>Applications for DLP Standard chipsets</p>	<p>Laser TV > 85", smart projector, digital signage, enterprise projector, large venue, and cinema.</p> 

3 What is DLP Technology?

Some developers ask **what does *DLP* stand for**. The combination of these three letters do not have any meaning. DLP technology is the registered trademark brand name of the technology enabled by DMDs. Visit the [Texas Instruments DLP® Brand and Logo Guidelines](#) for additional information.

Texas Instruments DLP technology is a fast-switching micro-electro-mechanical systems (MEMS) technology that modulates light using a digital micromirror device (DMD) [Figure 3-1](#). DMDs vary in resolution and size and can contain over 8 million micromirrors. Each micromirror can represent either one or more pixels on a display. The micromirrors are independently controlled and synchronized with color sequential illumination to create stunning images on virtually any surface. In some cases, the combination of the speed of the DLP chip, proprietary algorithms, and an optical actuator located inside the optical engine, can increase pixel density achieving an effective pixel pitch as small as $2.7\mu\text{m}^3$.

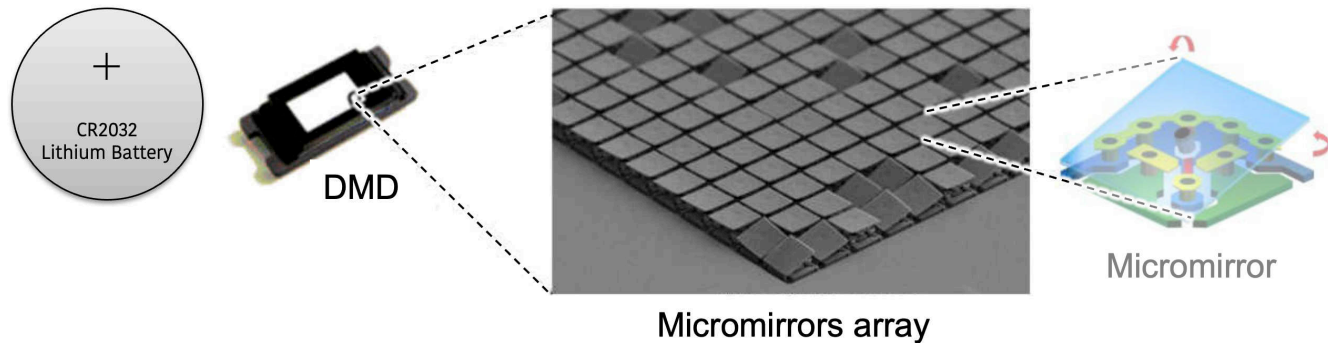

Figure 3-1. Digital Micromirror Device

Here is a [video](#) that illustrates how DLP technology works to create a stunning image.

³ $2.7\mu\text{m} : 5.4\mu\text{m}$ TRP pixel node using a 4-way actuator

4 The DLP Display System

The display system starts with a video input signal and results in a stunning projected image. A display system needs three main components to operate: DMD, DLP display controller, and power management integrated circuit (PMIC). [Figure 4-1](#) illustrates the typical block diagram of an LED DLP display system. You can also [click here](#) for a video that covers the block diagram of a DLP display system in detail.

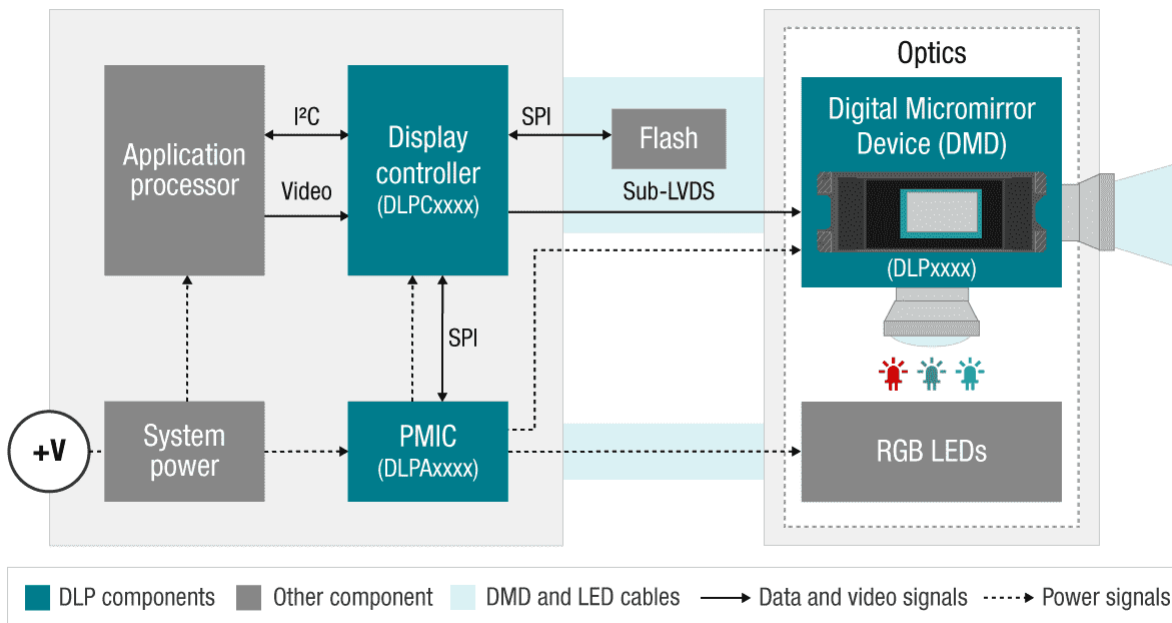

Figure 4-1. Typical DLP Display Block Diagram

The display system requires two primary connections: power and data. Power must be supplied to the DLP PMIC. Digital video data (including 24-bit RGB, DSI, or Vx1) must be supplied to the DLP display controller chip. A media processor, which accepts external sources like HDMI and processes streamed online content, sends digital video data out to the DLP display controller. Alternatively, a product's application processor, such as in a smartphone or tablet, can also send digital video data to the DLP display controller.

4.1 Component Part Number Identification

[Table 4-1](#) provides some general guidelines on part number nomenclature for the DLP display chipset.

Table 4-1. DLP Display Chipset Nomenclature

Component	Part Number Description
DMD	DMD part number begins with the letters DLP followed by two numbers that represent the active array diagonal in inches. Following digits vary for each unique component. <i>Example: DLP4710, DLP DMD with .47-inch diagonal</i>
Display controller	DLP display controllers begin with the letters DLPC followed by other digits that vary for each unique component. <i>Example: DLPC3439, DLP Pico .47 1080p display controller</i>
PMIC	DLP PMIC components begin with the letters DLPA followed by other digits that vary for each unique component. <i>Example: DLPA2000, DLP Pico PMIC supporting up to 200mA of LED drive current</i>

The display system is split up in electronics and optical module hardware.

4.2 Electronics Hardware

The electronics portion of the display system starts with a video input signal (for example, 12/16/18/24-bit RGB (red, green, blue) parallel, DSI, FPD-Link or Vx1 interfaces, typically driven by an application or media processor. The output of the electronics portion includes video signal to the DMD commonly using low voltage differential signaling (LVDS) or Sub-LVDS, illumination drive, and power. [Figure 4-2](#) shows an example of the electronics hardware.

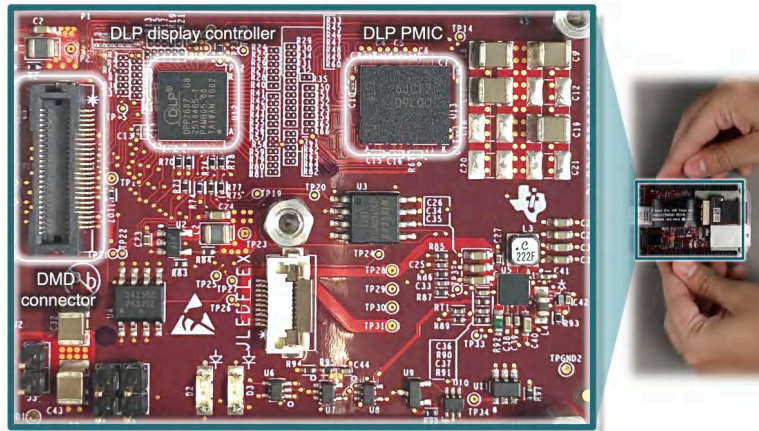

Figure 4-2. DLP .2 nHD (DLP2000) Chipset Evaluation Module (EVM) Electronics

Table 4-2 includes the components of the electronics portion of the display system.

Table 4-2. Electronic Components

Component	Description
Applications processor	The function of the applications processor is to deliver the video signal to the DLP display system as well as inter-integrated circuit (I2C) interface to provide command and control functions. Any video-capable processor should be able to handle this task.
Display controller	<p>The DLP display controller is the digital interface between the DMD and the rest of the system. The controller takes digital input from an applications processor and drives the DMD over a high speed interface. The DLP controller also generates the necessary signals (data, protocols, timings) required to display images on the DMD. Each display controller has a software user's guide that details all its supported video handling functions, which will vary depending on the DLP chipset selected. To see an example software programmer's guide for the .47 1080p DLP Pico chipset (DLP4710), see the DLPC3439 Software Programmer's Guide.</p> <p>Video signal inputs</p> <ul style="list-style-type: none"> • Video interface. The DLP display controller can support a wide range of video interface inputs. 8/16/18/24-bit RGB parallel interface is most common across the DLP portfolio. In some cases, DSI is supported for ultra-portable and embedded applications, and Vx1 for 4K resolution. In a few cases, the video interface input will come from a Field Programmable Gate Array (FPGA) (In such cases, FPD-Link may be supported). • I2C is used to command and control the display controller, typically connected from the application processor • PROJ_ON signal is used to power on/off/reset the display system <p>DMD signal outputs</p> <ul style="list-style-type: none"> • DMD video interface. Depending on the chipset, the display controller will commonly output a Sub-LVDS or LVDS signal to the DMD. • Serial Peripheral Interface (SPI) . Command and control communication with the DLP PMIC (if supported) <p>The display controllers support image processing that helps optimize the image quality displayed, including data compression. A DLP Light Control chipset should be used if precise pixel to pixel mapping is required (typically used in structured lighting applications, learn more here). Image processing features depending on the chipset could include TI DLP® IntelliBright™ Algorithms for the DLPC343x Controller, DLP BrilliantColor™ technology, image keystone correction, warping, blending, frame rate conversion, integrated support for 3-D displays and more. Some systems require dual controllers to format the incoming data before sending it to the DMD. The DMD and its appropriate controller are required to be used together in a system design to ensure reliable operation.</p>
FPGA	<p>Some chipsets incorporate a technology which creates either two or four pixel images on the screen from a single DMD micromirror. This is accomplished through a combination of proprietary image processing coupled with an optical actuator. The actuator is an opto-mechanical element which is positioned in the optical path between the DMD and the projection lens, and which has the ability to slightly alter the direction of the projection light rays. A 2-way actuator can direct light into two discrete directions, and a 4-way actuator can direct light into four discrete directions. The proprietary image processing converts the image data (from the customers application processor) into either two or four sub-frames of data. These sub-frames of data are then displayed on the DMD, synchronized with the direction-state of the actuator. For chipsets which incorporate this technology, the image processing is performed in an FPGA which sits in the data path between the customers application processor and the DLP controller. This FPGA is designed to receive data in the same manner that a DLP controller would, and generate both the sub-frame data as well as actuator control signals:</p> <ul style="list-style-type: none"> • Video interface input from the application processor. Typically RGB parallel, Flat Panel Display Link (FPD-Link), or Vx1 interfaces. • Video interface output and I2C connected to the display controller(s). • Actuator output drive data (DAC_DATA and DAC_CLK) responsible to drive the actuator wave-form synchronous with video sub-frames.

Table 4-2. Electronic Components (continued)

Component	Description
PMIC, LED drive, and motor driver	In most cases, a DLP PMIC is responsible for providing input power to the DLP display controller, DMD, and LED illumination components. The PMIC takes care of supplying core voltages related to the DLP chipset and gently power sequencing the DMD to ensure correct operation. It also provides other monitoring and protection functions, and dynamic LED control based on image color content (for example, <i>TI DLP® IntelliBright™ Algorithms for the DLPC343x Controller</i>). Integration of the power supply and LED driver circuitry in a small IC not only allows for small-size electronics to be designed, but also reduces the product design cycle time. A motor driver is also needed for systems that include a color wheel. This capability provides a color wheel motor drive control for phosphor laser illumination-based applications, as well as switching regulators and adjustable linear regulators for customer designed peripherals. It supports two peripherals by supplying three fan drivers and one 3-phase Back electromotive force (BEMF): motor driver or controller for a color wheel.
Flash memory	Application-specific configurations are stored in the Flash memory. This component is typically placed on the electronics board or the DMD flex cable.

DLP display controller and PMIC that accompany the DLP Pico DMDs are very small enabling extremely compact display products. Figure 4-3 shows both sides of an example printed circuit board design (estimate only) with the DLPA2000 PMIC and the DLPC3430 controller device, which drives a .2 WVGA (DLP2010) DMD.

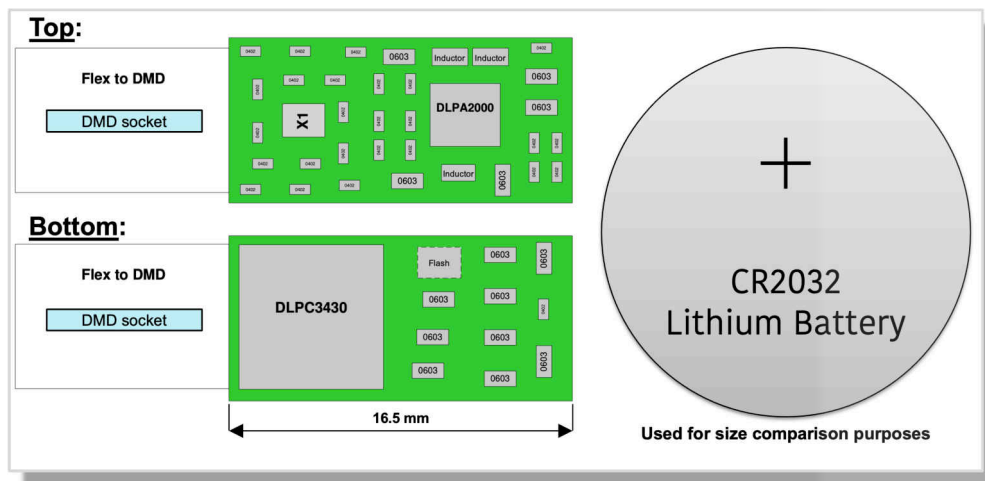

Figure 4-3. Example of a Small Board Design

4.3 Optics

The DMD, along with its associated electronics, an illumination source, optical elements, and necessary mechanical components, are combined into a compact and rugged assembly known as an optical module or light engine (Figure 4-4). The optical module is the core display component of the system. Optical modules can be of various sizes depending on the application and requirements. In general, the higher the brightness, the larger the size of the optical module due to the use of larger illumination sources, optics, DMDs, and thermal management components such as heat sinks and fans.

The optics portion of the display hardware system starts with electric signals going into an optical module housing that include all the components needed to create a projected image. General information about optical modules are located [here](#) for DLP Pico chipsets and [here](#) for DLP standard chipsets.

The DMD is connected to the DLP Pico controller by a flex cable or board-to-board connector. The LEDs in the optical module are connected with wires to the DLP PMIC (LED driver). System boards, fans, heat sinks, mechanical parts, switches, and other parts are assembled into a compact and robust final product around the optical module.

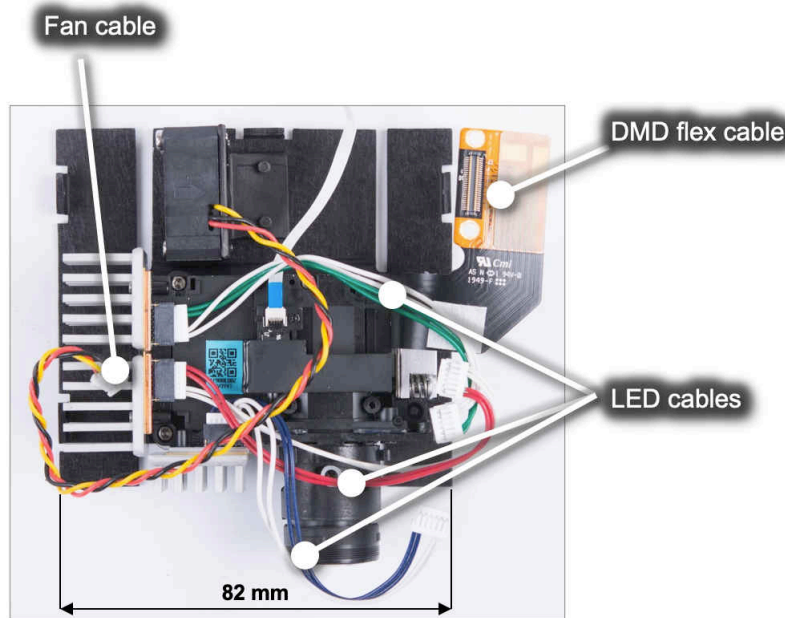

Figure 4-4. DLP Pico .23 1080p (DLP230NP) Display Optical Engine

Figure 4-5 shows the optical components that can be included in an optical module. Click [here](#) to watch a video of an example optical module reference design (.23 qHD DMD; DLP230GP). Keep in mind that details of an optical module may not be relevant for a company that is planning to source a mass production optical engine. To read an application note that covers in detail how to specify an optical module, see [TI DLP® Pico™ System Design: Optical Module Specifications](#). Also, click [here](#) to search for optical modules in mass production available for purchase. Figure 4-5 shows an optical module design example from [DLP2010 DMD Optical engine reference design](#).

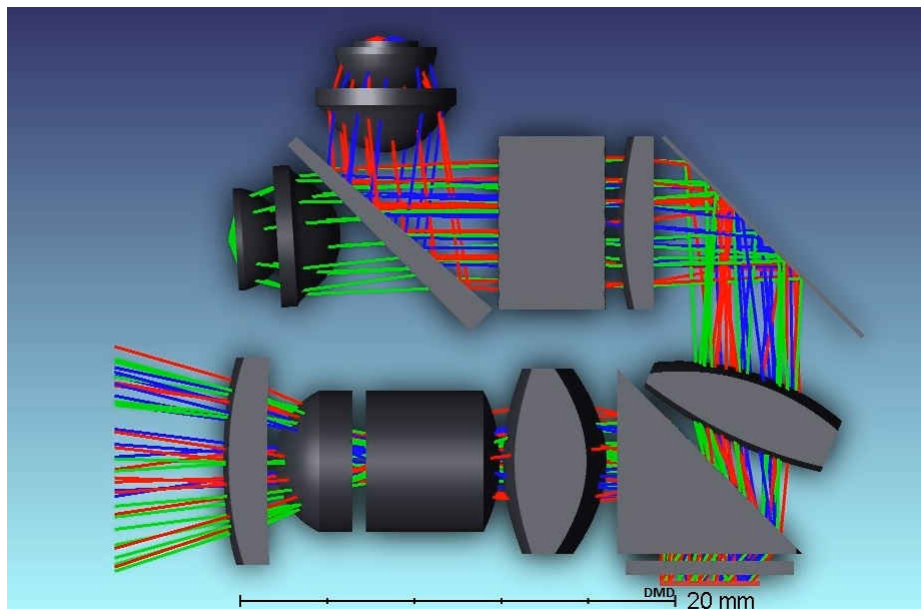

Figure 4-5. .2 WVGA (DLP2010) Optical Module Example

Table 4-3. Optical Components Included in an Optical Module

Components	Description
DMD	<p>The digital micromirror device is the component that houses the active digital micromirror array, which allows the creation of a color plane, which enables the projected image in combination with the illumination source. Each DMD has the following unique characteristics:</p> <ul style="list-style-type: none"> • Active array, includes diagonal size of the imager and number of pixels on the imager • Pixel architecture, includes (a) tilt angle relative to the flat surface, including 12° and, more recently, 17° micromirror tilt; (b) shape of the micromirror including orthogonal and diamond-shaped pixels; (c) pixel pitch, including 7.6 μm or 5.4 μm; and (d) illumination direction, including side, bottom, and corner illumination. • Video interface, depending on the chipset, a signal provided by the display controller provides the video data input required to update the active array, including sub-LVDS or LVDS interfaces.
DMD mounting mechanism	<p>The mounting of the DMD includes several needs: (a) proper placement of the DMD's active array relative to the optical axis of the application, (b) a dust-proof seal between DMD and the optical assembly chassis, (c) reliable electrical connection, and (d) proper thermal management. To learn more about mounting concepts for various DLP chipsets, see Mounting Hardware and Quick Reference Guide for DLP® Advanced Light Control DMDs.</p>
DMD flex cable	<p>Cable used to transport electrical signals between the DMD and the display controller.</p>
Illumination source (color mechanism)	<p>DLP technology is illumination source agnostic. The illumination sources that are broadly available today are RGB LED and laser phosphor.</p> <p>RGB LED illumination. This illumination scheme uses red, green, and blue LEDs displayed with a single-color plane refresh rate. In some cases, a fourth LED will be used to increase brightness, although this brightness increase is penalized heavily against power efficiency. A 3-channel architecture could support brightness efficiency over 20 lumens/Watt (lm/W), while a 4-channel architecture will support brightness efficiency lower than 10 lm/W.</p> <p>Laser phosphor illumination. This illumination approach uses a single blue laser source diffused in combination with one or two phosphor color wheels to provide RGB light sources. Some implementations add a red or green channel to boost color performance.</p> <p>RGB Laser illumination. This illumination approach uses red, green, and blue laser sources. A de-speckler optical element is typically used for this implementation to improve image quality, although it is not required.</p>
Optical actuator (if needed)	<p>The DMD fast speed allows a use of an optical actuator. 2-way and 4-way actuators that meet TI specifications are used to increase on-screen resolution while retaining the optical benefits of a 5.4μm pixel node.</p> <p>2-way actuator, products like the DLP Pico .33 1080p (DLP3310) use a 2-way actuator to double the on-screen resolution of the DMD active array.</p> <p>4-way actuator, products like the DLP Standard .47 4K (DLP471TE) use a 4-way actuator to quadruple the on-screen resolution of the DMD active array</p>
Homogenizer	<p>The function of the homogenizer is to make the intensity profile of the light source to be more uniform. Typically, a fly's eye array or light tunnel are used for this purpose. The optical element is located between the illumination source and the DMD.</p>
Projection lens	<p>The purpose of the projection lens is to magnify the image coming from the DMD to the display surface. It also determines the throw ratio, defined as the distance between the projection lens and the display surface divided by the width of the displayed image. It also determines the image offset of the projection lens relative to the display surface. Watch this video to learn more about throw ratio and image offset.</p>
Illumination projection interface	<p>This optical element is responsible to interface between the DMD and projection optics. A few options include field lens, non-telecentric, total internal reflection (TIR) prism, and reverse TIR (RTIR) prism.</p>
Thermal management	<p>To ensure the proper operation of the optical module, it is important to consider thermal management for the DMD and the illumination sources. Watch this video to see an innovative example of thermal management for a very small projection-based smart display.</p>

Watch this [video](#) to get more details on common projection lens specifications, including throw ratio definition, offset definition, and telecentric and non-telecentric architecture comparison.

5 Selecting the Correct DLP Display Chipset

There are several factors to consider selecting the correct chipset. To get started quickly, there are resources available that you can leverage as shown in [Table 5-1](#).

Table 5-1. Resources Available

Resource	Example
<p>To get a comparison of all the DLP display chipsets available today, see the Texas Instruments DLP® Display & Projection Chipset Selection Guide.</p>	
<p>Watch this video to receive some general idea on how to select the correct chipset for your application.</p>	

The following qualifiers should help you down select the DLP chipset that you need for your display application:

Portfolio overview: DLP display products have a wide range offering starting at a nHD resolution supporting 50 lm up to 4K resolution supporting over 10,000 lm. There are two general offerings:

- **DLP Standard chipsets.** These products are optimal for large displays with high brightness and resolution requirements ranging from .55 XGA ([DLP550JE](#)) resolution to 0.66 4K UHD ([DLP660TE](#)) resolution. These chipsets are also referred as Enterprise and Cinema Display (ECD) chipsets.
- **DLP Pico chipsets.** With mirror arrays ranging from 0.2-inch to 0.47-inch, DLP Pico products are ideal for small applications. From nHD ([DLP2000](#)) to 4K UHD ([DLP471TP](#)) resolutions, DLP microdisplay brings colorful and crisp images to virtually any surface.

5.1 Brightness

Brightness requirement (measured in [lumens](#)) varies depending on a range of factors, including image size, ambient light, and nits. The brightness requirement will affect the diagonal size of the DMD active array. You can learn more on how to select the right brightness level for your application by reading [TI DLP® IntelliBright™ Algorithms for the DLPC343x Controller](#) or watching this [video](#).

- **Brightness vs power consumption.** In general, the brighter the projection module, the higher the power consumption (driven mainly by the illumination power). For embedded applications, a target power of 1 to 2 W is typical, while accessory projectors can range from a few watts to tens of watts. In the case of LED illumination sources, efficiency is typically not linear, meaning **doubling the power to the LEDs results in less than double the brightness**. Finding the right balance of brightness and power consumption is important.

- **Brightness vs size**, optical modules can vary greatly in size from a few cubic centimeters in embedded smartphone or tablet applications to hundreds of cubic centimeters in high brightness accessory projectors. In general, projection modules with higher brightness capability are larger in size. A larger illumination source, optics, and DLP DMDs may be used in order to achieve a higher brightness. The power and heat generated by the illumination source increases as the brightness increases. Heat dissipation requirements add to the size if heatsinks or fans are necessary. The size of small, low power DLP Pico systems is driven mainly by the size of the optical module, while the size of larger, higher brightness DLP display systems is driven not only by the size of the optical module but also the size of the thermal solution.

5.2 Resolution

Depending on your application, you will require a minimum resolution to achieve a good image quality on the display. [Figure 5-1](#) provides a general idea on what resolution is required depending on viewing distance, image size, and content type.

Image Diagonal (inches)	Minimum Required Resolution (horizontal pixels)		
	Good	Better	Best
200	1230	1846	2460
160	1200	1802	2402
120	1158	1736	2314
100	1122	1684	2248
80	1076	1614	2154
70	1046	1568	2090
60	1006	1510	2014
50	956	1436	1914
40	890	1334	1780
30	798	1196	1594
25	734	1102	1470
20	660	988	1318
15	560	842	1122
10	432	648	864
Image Quality	Good	Better	Best

Assumptions

- Throw ratio: 1.2:1
- Aspect ratio: 16:9
- Viewing distance: 2' behind projection lens
- Pixels per degree requirements
 - Good: 30 pixels per degree
 - Better: 45 pixels per degree
 - Best: 60 pixels per degree

Target Resolutions
4K UHD (3840x2160)
1080p FHD (1920x1080)
720p HD (1280x720)
qHD (960x540)
WVGA (854x480)
nHD (640x360)

Figure 5-1. Minimum Target Resolution

5.3 Size

You may have very demanding end product size requirements. The size of the optical module, which determines the overall physical size of the product, derives from a few considerations including:

1. Brightness level as stated earlier
2. Illumination source
3. **f-number**, optical system focal length divided by diameter of the entrance pupil (effective aperture)
4. **Throw ratio or magnification**, the shorter the throw ratio, the larger the optical module due to larger optical components such as lenses and mirrors
5. Thermal management

6 How to Evaluate Selected DLP Display Chipset

After selecting the right chipset for your application, you can purchase a DLP Display LightCrafter™ evaluation module (EVM). The EVM has a few key features that will help you finalize your chipset and brightness level selection, and software configuration settings.

- **Image quality assessment.** The tool provides you with an optical module at a specified brightness level. Keep in mind that you may find projectors in the market that advertise a specific brightness; you should measure the brightness of those projectors yourself to verify the measurement of each individual product.
- **Modifying chipset software parameters.** Most of the EVMs can be used with a PC Windows software package to make display changes including test patterns/images, color temperature, keystone, DLP IntelliBright™ algorithms, and RGB LED current modifications. The PC tool can also update the firmware of the EVM.

Figure 6-1 shows an example screen capture.

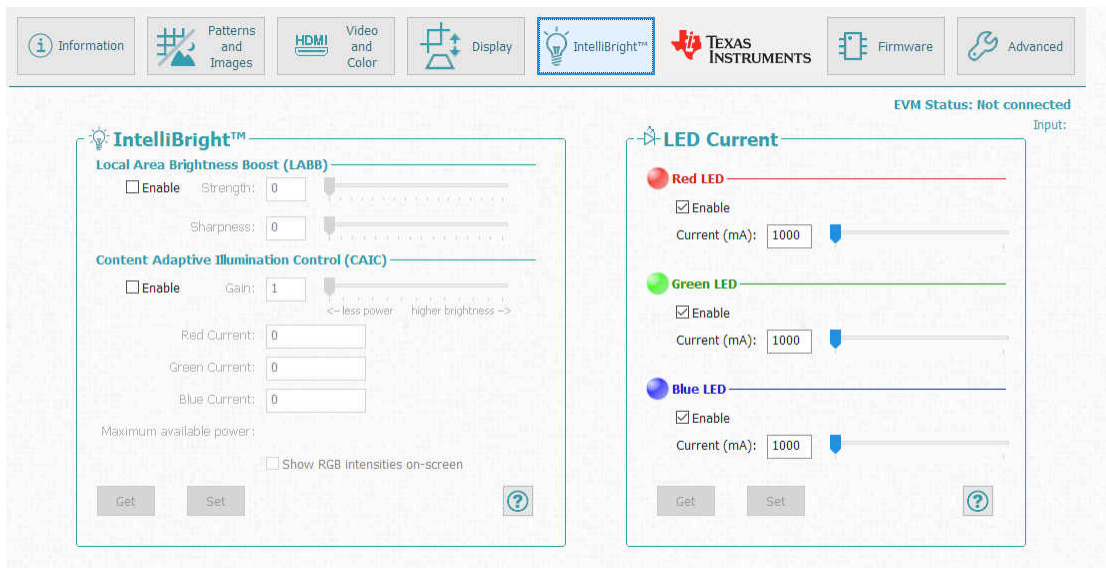

Figure 6-1. .33 1080p (DLP3310) EVM PC Tool DLP IntelliBright Algorithms Screen

In a few cases, the EVM can connect to a single board computer (SBC) to enable customization of the display instead of using a PC software. This is the case for the .2nHD (DLP2000) and the .23 1080p (DLP230NP) DLP Pico chipsets.

- **I2C communication.** In all cases, I2C is used to command/control the chipset to enable various software features documented with the chipset’s software users guide. I2C communication can be done directly with all EVMs. However, each EVM has its unique requirements on how to do so.
- **DLP Pico Firmware selector.** For DLP Pico products, you can [download](#) a broad selection of firmware options that will vary depending on the chipset, PMIC, display controller pin-mapping, and application profile.
- **Optical module options.** You may want to look at various optical module choices for a specific chipset offering including different levels of brightness, throw ratio, contrast, and optics design. Our [optical module search tool](#) allows you to choose from many optical modules available in the market today. You can contact the optical module maker to learn more about the module. Seldom a production optical modules can be connected directly to a DLP EVM. The optical module manufacturer may need to offer you with their own evaluation tool or instructions how to connect to the TI EVM. Notice the EVM comes rated for a specific LED current drive, which needs to match with the desired optical module.

7 Selecting the Correct Optical Engine

7.1 Optical Module Selection

There are a lot of optical module choices to select from. It is important that you know exactly what optical module you need to specify. You can read the [TI DLP® Pico™ System Design: Optical Module Specifications](#) to understand optical module specifications and other related system design considerations. After deciding what optical module specification meets your needs, you should document that specification to share it with optical module maker candidates. All of the terminology used in the example below are thoroughly explained in the application note.

Table 7-1. Example Optical Module Specification Table

Specification	Priority Rank	Target	Boundary (min/max)	Example
Description	Provide a high level description of the application and <i>must-have</i> optical module specifications/features.			
Brightness (lumens)				> 30 lumens
Resolution (x by y pixels)				854 × 480
Size (x-y-z dimensions in mm) – note if one dimension is higher priority				25 mm × 25 mm × 6 mm (minimize thickness)
Power consumption (watts)				< 1.5 W
Throw ratio				1.0 - 1.5
Offset (typically 0% or 100-120%)				100%
Optional Specifications				
Brightness uniformity				> 70%
Contrast ratio (full on, full off)				> 500:1
Contrast ratio (checkerboard)				> 200:1
Optical zoom (note as required or not required)				Not required
Long depth of focus (note as required or not required)				Not required
Focus method (for example, manual, motorized, autofocus)				Motorized

7.2 Optical Module Sourcing

There are a few ways to source an optical module. The quickest one, source an optical module that is already in mass production from an optical module maker. In some cases, you may want to make some modifications to the optical module. For that case, you can work with an optical module maker to customize a catalog optical module to meet your needs; the optical module maker may require some commercial terms and conditions to support you as it may require tooling optical components. If your company has optics expertise, then you can design the optical module and find a company to manufacture it or manufacture it in-house. Also, you can contract with a third-party optical engine design house that can design the optical module for you, which can be manufactured by the design house or an optical module maker.

In some cases, the DMDs will include an optical module design guide that can help you understand the requirements for that specific chipset.

8 DLP Products Supply Chain

Aligned with the division of hardware electronics and optics, it is common to have the following supply chain arrangement:

- **Texas Instruments** designs and supplies DLP chipsets (DMD, controller, and PMIC).
- **Optical module maker (OMM)** designs the optical system and supplies entire optics housing including the DMD, illumination source, flex cable, and heatsinks (in some cases).
- **System integrator** designs the electronics and casing and supplies final product, including optical module and DLP chipset.

In some cases, the system integrator will design and supply the optical module as well.

9 Development and Manufacturing

Our experts have consolidated a list that is useful as you move along with your development and ramp of your display application.

9.1 Electrical Considerations

- Do not exceed recommended operating conditions
- Choose a flash device memory size by using DLP Composer™ software to create example firmware builds similar to what you will need in your products.
- Based on your LED voltages and currents needed, select the DLP PMIC that is best suited for use in your product
- Read all applicable user guides and electrical application notes; follow the guidance given pertaining to the DLP chipset
- Use TI reference schematic and layout guidelines when designing a PCB using the DLP chipset

9.2 Software Considerations

- Use DLP Composer software to configure the DLP chipset firmware stored in the flash device as needed by your product
- Use the software programmer's guide for the DLP chipset to learn the I2C (or USB) commands that can be input to control the DLP chipset
- Consider implementing the following image manipulation features integrated in most DLP display controllers:
 - 1D keystone correction to vertically compensate the image geometry for a projection engine that is not perpendicular aligned with the viewing surface.
 - DLP IntelliBright™ algorithms for DLPC343x series, **CAIC and LABB** to increase up to 50% brightness with the same power or decrease power by 50% without decreasing the brightness.
 - Warping and DynamicBlack for DLPC654x and DLPC754x series for compensating the image on irregular viewing surfaces and enhanced contrast ratio capability.

9.3 Optical Considerations

- Minimize illumination overfill to reduce heat load on the DMD and maximize light output.
- A light absorber may be required to eliminate or minimize off-state light resulting from thermal or optical issues.
- Properly manage off-state light for contrast purposes away from projection optics by maintaining the pupil separation of the illumination and projection light bundles. This is dependent on the DMD pixel architecture, illumination angle, and F/#.
- TIR or reverse-TIR prisms are effective in separating illumination and projection light in telecentric systems. Be conscious of the refractive index and ray angles for proper light path transmission.
- In non-telecentric systems, make sure the optical ray angles do not exceed the DMD max ray angles. At high angles of incidence, the transmission of the DMD window is reduced but also light may be vignetted within the DMD package apertures. This could produce poor uniformity in the image.
- Depending on the brightness level, be conscious of the optical materials used such as glass vs plastic. Certain plastic materials may not hold well with high flux density or in high temperatures reducing optical efficiency, image quality, or both.

9.4 Mechanical Considerations

- Do not exceed mechanical mounting recommendations
- The DMD data sheet defines thermal and electrical interface areas and the maximum load (force) that can be applied to each area. Exceeding the maximum load can damage the DMD
- When mounting the DMD the loads applied can be **controlled by design**, or **assembly process**.
 - **Controlled by design** is a design where features of the design prevent loads on the DMD that can exceed the maximum. These typically utilize shoulder screws and a spring element (flat or coil springs)
 - **Controlled by assembly** is a design that relies on the assembly process to ensure the loads on the DMD are not exceeded. These typically utilize procedures and torque of screws
 - **Control by design is the most robust design**

9.5 Thermal Considerations

- Design to be as cool as practical
- Design the product to meet recommended operating conditions when the DMD is operating. Absolute maximum ratings are provided as a guide for short term life testing and not long-term operation
- Storage Conditions are always applicable the DMD is not operating. This includes times when before and after the DMD is installed
- Design the cooling to comprehend the full temperature range the DMD will be used. To help meet the DMD temperatures in extreme ambient conditions the speed of the cooling fans could be increased, or the optical power reduced
- Thermal testing early using a thermal mockup before part designs are finalized and tooling started allows simple changes to be made that can improve thermal performance without impacting schedule or tooling costs.
- Refine the thermal mockup as the design matures and do additional testing.
- The DMD data sheet identifies specific thermal test point locations that should be used when doing thermal testing.
- The T_array specification in the DMD data sheet is the calculated array temperature from the identified thermal test point. A sample calculation is provided in the data sheet.
- Thermal testing of the DMD should be done in the enclosure of the unit. Thermal testing of a standalone optical module has very different airflow and cooling characteristics which results in very different temperatures than those in the enclosed unit.

9.6 Manufacturing Considerations

- Never hot-swap the DMD during assembly
- Follow all power-up and power-down requirements
- Do not over tighten mechanical mounting hardware
- To prevent stress concentration and uneven loads applied to the DMD tighten the mounting screws partially before final tightening
- Use low power illumination during optical alignment to avoid overheating the DMD aperture or bond line
- DMD temperatures should always be met during assembly (illumination alignment, characterization/testing, burn-in), storage, and operating
- Exceeding the DMD window temperatures for even a brief period, like illumination alignment, can permanently damage the DMD that will not be detectable during the manufacturing process

10 Online Resources

This section is a reference to assist you to quickly identify resources available with the chipset you selected.

10.1 DLP Chipset Information

The best method to identify all resources associated with each chipset is to visit the product page of the DMD, controller, and PMIC of interest. In those pages, you can find information as shown in [Table 10-1](#).

Table 10-1. Resources Available

Component	Resources
DMD	Data sheet Product details <ul style="list-style-type: none"> Data sheet highlights Packaging Technical Documentation <ul style="list-style-type: none"> Application-specific technical documents and white papers Mounting and electrical interconnect information Optical reference design example DMD optical efficiency Design and development <ul style="list-style-type: none"> Chipset evaluation module (EVM) information Display system reference designs
Display controller	Data sheet Software programmer's guide Image calibration PCB design requirements IntelliBright algorithms Chipset EVM information Real-time color management reference design IBIS models Firmware selector
PMIC	Data sheet PCB design requirements

Table 10-2. Popular Resources

Resource	Description
DLP Pico display getting started website	Quick getting started content to help learn, select, evaluate, and develop DLP Pico display applications
Product selection documents	
Product selection video	Training that illustrates how to select the right DLP display chipset based on a few parameters
Texas Instruments DLP® Display & Projection Chipset Selection Guide	Includes all DLP display chipsets available in mass production
Brightness trade-offs DLP System Design: Brightness Requirements and Tradeoffs and video	Provides guidelines on how to select the right brightness level (lumens) for your application
Optical module selection documents	
Common projection lens specifications video	Video explaining how a projection system performs and an application note that provides guidelines on how to specify an optical engine.
OMM search tool	Comprehensive mass production-ready optical modules available worldwide
Design resources	
E2E forum for DLP Products	Forum that you can use to ask questions to our experts as well as review technical questions that may have already been addressed

Table 10-2. Popular Resources (continued)

Resource	Description
PCB design requirements for PCB Design Requirements for DLP® Standard TRP Digital Micromirror Devices and PCB Design Requirements for TI DLP Pico TRP Digital Micromirror Devices TRP chipsets (myTI login required)	Electrical recommendations on how to layout electronics to interface the display controller with the DMD

11 Common Display and Projection Terminology

Table 11-1 provides common display and projection terminology.

Table 11-1. Common Display and Projection Terminology

Term	Description
Brightness	Brightness is a measure of how much light is perceived by the human eye in a given scene. This is a function of the amount of light (number of photons) and their spread across the color spectrum (photon energy), as well as the varying sensitivity of the human eye across the visible spectrum (most sensitive in the yellow-green region, less sensitive in the blue and red regions). The International System of Units (SI) identifies the lumen as the unit of measurement for brightness
Lumens	A DLP projector will often be specified by the number of lumens it is capable of delivering in its projected image. The brightness (lumens) determines how large a screen the projector can create and still be viewable in a given ambient light environment. The greater the brightness, the bigger the displayed image can be made. End products utilizing DLP display technology can range from 20-30 lumens in smartphones and tablets to greater than 50,000 lumens in digital cinema projectors
Contrast	The quality of a displayed image is greatly dependent on the distinction between the brightest and the darkest areas of the viewed image. This is quantified by the contrast ratio, which is the ratio of the brightest possible region of the image to the darkest possible region of the image. While the contrast ratio specification of a DLP system is based on system performance, the viewing experience can also be greatly impacted by ambient light. The more ambient light on the screen, the lower the viewable contrast of the image. Together, system contrast and ambient light determine the true viewable contrast of the image. Special attention must be given to the optical design, and quality of optics used in the optical module to maximize contrast.
Resolution	The level of detail available in an image is determined by the number of pixels which make up the displayed image. In a DLP system, this is a function of the number of mirrors on the DMD which can represent one or more pixels of the displayed image. Resolution is the number of pixels that can be displayed. The level of detail displayed is not only dependent on the resolution of the projector system but it is also dependent on the resolution of the source content. If the resolution of the source content does not match the resolution of the projector system, the source content is mapped by the controller to make maximum usage of the resolution displayed. DLP display resolutions range from 640 × 360 (nHD) to 3840 × 2160 (4K UHD).
Keystone	<p>When the optical axis of a projection system is not perpendicular to the imaging screen, the image will be geometrically distorted. One of these distortions, caused by the different distance to the screen top and bottom, is called keystone distortion. The resulting image will have a different width from top to bottom, giving the image the shape of an architectural keystone (used at the top of an arch). This distortion can be avoided by keeping the projection axis perpendicular to the screen. However, this is sometimes unavoidable. The keystone distortion can be corrected optically (very difficult, cost prohibitive, not adjustable) or by image processing means. DLP controllers provide keystone correction by re-mapping the input image to the DMD array in such a way as to produce a rectangular image at the screen. The keystone correction feature is commonly paired with an accelerometer in the system to automatically adjust the image as the projector is tilted up and down.</p>  <p style="text-align: center;">Figure 11-1. Vertical Keystone Correction</p>
Color sequential display	DLP DMDs are made up of micromirrors. They only reflect the light which illuminates them. So, how can a DMD chip reproduce full color images? The secret is in the way the human eye works. The human retina and brain synthesizes perceived color by means of a short-term time averaged differential response to the quantity of light impinging on the 3 types of retinal cones (red sensitive, green sensitive, blue sensitive). Since the eye continuously averages the light striking the retina over a period of about 1/50 second, it is possible to illuminate the eye sequentially at a sufficient rate with red, green, and blue images such that the viewer perceives the impression of full color images. This is achieved by a DLP optical module by sequentially turning the R, G, B light sources on and off such that there is, for example, a red image, followed by a green image, followed by a blue image.

Table 11-1. Common Display and Projection Terminology (continued)

Term	Description
Front projection / rear projection and screens	A DLP display system uses an optical system to produce a real image of the pixel pattern displayed on the DMD. In order for the projected image to be seen by viewers, the light must be scattered off a surface co-located with the plane of image focus. This function is provided by a screen, which may be a specially optimized sheet of material, or simply a wall, floor, or counter top – any smooth, light colored surface can make a great image. In a front-projection system, the screen must be a reflective surface. A rear-projection system requires a translucent, dispersive screen. In both cases the viewer focuses their eyes on the screen in order to see the projected image. There are some display systems which work by producing a virtual image. For example, near eye displays and heads-up displays create images that are only formed after the light travels through the eye onto the retina
Offset	<p>The DMD in many DLP projectors is offset to a position below the optical axis of the projection lens in order to shift the image above the horizontal plane. This is useful when the projector is placed on a table to avoid cutting off the bottom of the projected image. The offset also avoids the distortion of the image which would occur if the projector was simply tilted up.</p> <div data-bbox="617 441 1185 714" style="text-align: center;"> </div> <p style="text-align: center;">Figure 11-2. Offset Effect on Projected Image</p>
Throw ratio	<p>In many projection applications, the placement of the projector with respect to the viewing screen is important. The throw ratio of the projector determines how far away the projector must be placed in order to achieve a certain screen size. The width of the projected image (W) with respect to the distance from the lens to the center of the screen (D) is the throw ratio (T).</p> <p>Common references to throw ratio: standard throw: throw ratio>1; short throw (ST): 1>throw ratio>0.4; ultra short throw (UST): throw ratio<0.4.</p> <div data-bbox="584 924 1234 1386" style="text-align: center;"> <div style="border: 1px solid black; padding: 5px; width: fit-content; margin: 10px auto;"> <p style="text-align: center;">Throw ratio = $\frac{l}{w}$ distance from the lens to the image horizontal width of the image</p> </div> <p style="text-align: center;">Figure 11-3. Throw Ratio Diagram</p> </div>
F-number	<p>The relative brightness of a projected image is a function of both the brightness of the illumination system and the aperture of the lens – that is, the width (D) of the lens opening with respect to the focal length (f) of the lens (determines the size of the projected image). This is expressed as a value called the F-number (N). $N = f/D$. The relative brightness (rb) of two lenses is a function of square of the inverse ratio of their f-numbers. $rb = (N_2 / N_1)^2$. For example, a lens of $N_1=2$ is 4x <i>brighter</i> than a lens of $N_2=4$. f-number impacts the system as a tradeoff between brightness and volume (dimensions). Higher f-number ($N=2.4$) systems are thinner, but may sacrifice brightness compared to a system with lower f-number ($N=1.7$) depending on its Etendue (typically applicable to LED systems).</p>
DLP chipset nomenclature	<p>It is common to refer to the DLP chipset by its active array diagonal, resolution, and portfolio as follows: [Array diagonal in inches] [resolution] DLP [Standard or Pico] chipset</p> <p>Example: .47 1080p DLP Pico chipset, refers to the DLP Pico chipset that has .47-inch diagonal active array that supports 1080p on-screen resolution.</p> <p>Table 4-1 provides a high level overview of the DLP chipset part number nomenclature for the DMD, DLP display controller, and DLP PMIC.</p>

12 References

- Texas Instruments: [DLP Products Messaging and Icons Guidelines](#)
- Texas Instruments: [DLPC3439 Software Programmer's Guide](#)
- Texas Instruments: [TI DLP® Pico™ System Design: Optical Module Specifications](#)
- Texas Instruments: [Mounting Hardware and Quick Reference Guide for DLP® Advanced Light Control DMDs](#)
- Texas Instruments: [Texas Instruments DLP® Display & Projection Chipset Selection Guide](#)
- Texas Instruments: [TI DLP® IntelliBright™ Algorithms for the DLPC343x Controller](#)
- Texas Instruments: [DLP System Design: Brightness Requirements and Tradeoffs](#)
- Texas Instruments: [PCB Design Requirements for DLP® Standard TRP Digital Micromirror Devices](#)
- Texas Instruments: [PCB Design Requirements for TI DLP Pico TRP Digital Micromirror Devices](#)

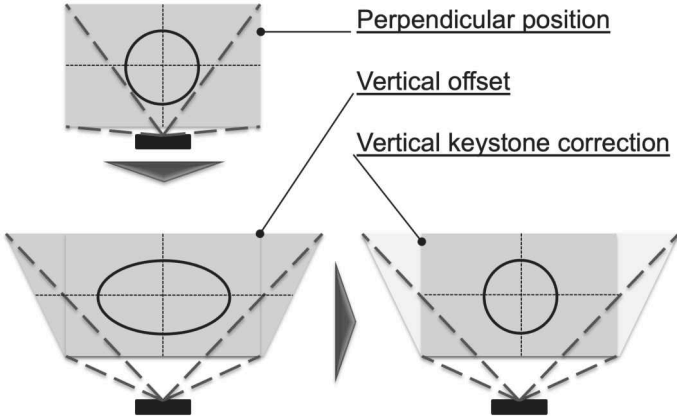
13 Revision History

NOTE: Page numbers for previous revisions may differ from page numbers in the current version.

Changes from Revision E (August 2021) to Revision F (August 2022)	Page
• Updated the numbering format for tables, figures and cross-references throughout the document.....	3
• Updated Section 2	4
• Updated Section 3	8
• Updated Section 4	9
• Updated Section 5	15

IMPORTANT NOTICE AND DISCLAIMER

TI PROVIDES TECHNICAL AND RELIABILITY DATA (INCLUDING DATA SHEETS), DESIGN RESOURCES (INCLUDING REFERENCE DESIGNS), APPLICATION OR OTHER DESIGN ADVICE, WEB TOOLS, SAFETY INFORMATION, AND OTHER RESOURCES "AS IS" AND WITH ALL FAULTS, AND DISCLAIMS ALL WARRANTIES, EXPRESS AND IMPLIED, INCLUDING WITHOUT LIMITATION ANY IMPLIED WARRANTIES OF MERCHANTABILITY, FITNESS FOR A PARTICULAR PURPOSE OR NON-INFRINGEMENT OF THIRD PARTY INTELLECTUAL PROPERTY RIGHTS.

These resources are intended for skilled developers designing with TI products. You are solely responsible for (1) selecting the appropriate TI products for your application, (2) designing, validating and testing your application, and (3) ensuring your application meets applicable standards, and any other safety, security, regulatory or other requirements.

These resources are subject to change without notice. TI grants you permission to use these resources only for development of an application that uses the TI products described in the resource. Other reproduction and display of these resources is prohibited. No license is granted to any other TI intellectual property right or to any third party intellectual property right. TI disclaims responsibility for, and you will fully indemnify TI and its representatives against, any claims, damages, costs, losses, and liabilities arising out of your use of these resources.

TI's products are provided subject to [TI's Terms of Sale](#) or other applicable terms available either on ti.com or provided in conjunction with such TI products. TI's provision of these resources does not expand or otherwise alter TI's applicable warranties or warranty disclaimers for TI products.

TI objects to and rejects any additional or different terms you may have proposed.

Mailing Address: Texas Instruments, Post Office Box 655303, Dallas, Texas 75265
Copyright © 2022, Texas Instruments Incorporated