

Replacing single-phase ACIMs with three-phase BLDC motors saves energy



Sandun S. Kuruppu
Systems Engineer

John K. Rote
Systems Engineer Manager

Motor Drive Business Unit
Texas Instruments

A single-phase ACIM versus three-phase BLDC motor efficiency comparison.

Single-phase and three-phase induction motors have been prominent in electromechanical energy conversion in industrial, residential and automotive applications. Advances in magnetic material technology have enabled alternative motor technologies such as brushless DC (BLDC) motors to emerge. This white paper compares permanent magnet-based, three-phase brushless DC machine-to-induction motor technologies in terms of efficiency.

Electric motors are widely used in numerous applications varying from appliances to power tools. A significant amount of motor applications are found in the form of fan applications such as:

- bathroom exhaust fans
- kitchen hood exhaust fans
- appliance cooling fans
- dryer exhaust fans
- desk fans
- inline fans
- axial exhaust fans
- attic ventilator fans
- roof ventilation fans
- radon fans

Typical ventilation fans vary from 30W to 80W for residential applications. Fan applications outside the residential segment can vary up to several kilowatts, based on the application. Brushed DC motors, single-phase AC induction motors, shaded-pole induction motors, three-phase induction motors or three-phase brushless DC motors are some of the common motors available for fan applications. Our analysis in this paper specifically relates to low-power fan applications that include ventilation fans.

Historically, single-phase induction motors dominated most low-power motor markets. At the time, a key disadvantage was magnet technology. Ceramic magnets available at the time could not deliver flux densities comparable to single-phase induction motors. Recent developments in magnet technology have enabled stronger magnets capable of producing torque levels that are equivalent to or

exceed the torque of single-phase induction motors of the same size. Motor selection for an application entails several criteria such as:

- system efficiency
- system cost
- power quality
- acoustic performance
- mechanical vibration and torque ripple
- product life

Efficiency standards and requirements

System efficiency being a key factor, efficiency standards for motors are defined by regional governing bodies such as International Electrotechnical Commission (IEC) in the European Union, and National Electrical Manufacturers Association (NEMA) in the United States (US). Present IEC motors standards have four levels. These IEC 60034-30-1 efficiency classes are:

1. IE1 (standard efficiency)
2. IE2 (high efficiency)
3. IE3 (premium efficiency)
4. IE4 (super premium efficiency)

These standards define the efficiency of 50 and 60 Hz motors with single- or three-phase windings built with any type of motor technology (brushless DC or induction, and so on) with power output higher than 120W.

NEMA provides guidelines in the US for motor efficiency standards, which are:

- Old Standard Efficiency Motor
- Prior NEMA EE
- NEMA Energy
- NEMA Premium

Similar to IEC standards, NEMA requirements for efficiency increase with higher output power. In our analysis, the assumption is that each motor is optimized for a specific application and each system is controlled by a power converter that drives the motor. Three-phase motors are controlled by a three-phase inverter stage (**Figure 1**), and the 'start/run capacitor single-phase induction motor' is controlled by a three terminal semiconductor (TRIAC) (**Figure 3**). Alternate single-phase induction motor drive methods include a transformer with several taps to control the average voltage applied, or using capacitors of different sizes in series with the auxiliary winding.

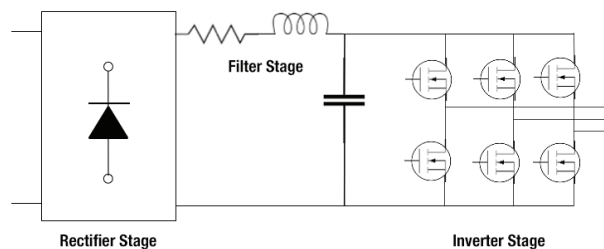

Figure 1: Drive stage for three-phase systems

Typical control strategy of BLDC motors in ventilation fan applications include position sensorless open-loop control or hall sensor-based open-loop control as speed regulation is not a requirement in most cases.

The inverter stage shown in **Figure 1** uses rectified line voltage to generate the DC bus voltage.

Efficiency of an electric machine is determined based on the actual work done for the given input power. Losses that occur in a motor are directly related to motor efficiency. Losses in an electric machine can occur in several forms which include:

- copper loss
 - stator copper loss ($P_{Cu,St}$)
 - rotor copper loss ($P_{Cu,Ro}$)
- core loss (iron loss, P_{Fe})
 - hysteresis loss
 - eddy current loss
- friction loss (P_{Fr})
- windage loss (P_{WIND})

Copper loss is also known as I^2R loss and is caused by the resistance in any current path. Due to pulse-width modulation (PWM) switching, the winding's effective resistance is increased. This phenomenon is caused by skin effect. The change in winding resistance due to skin effect is neglected in the analysis presented in this paper. Hysteresis loss is related to the characteristic of the material used in the stator and rotor material where the magnetic flux cycles. The material's B-H loop area is directly related to the energy lost during energy conversion.

Alternating magnetic fields in a conductor cause eddy currents (for example, in the motor material). The Circular electric currents that flow in the material contribute towards machine losses. Machine designers tend to use laminated material to reduce losses due to eddy currents.

Loss characteristics vary based on motor type and design. The following sections address loss models of three main motor technologies, followed by case studies that compare losses in a single-phase induction motor and a three-phase BLDC.

Single-phase induction motors

Single-phase induction motors are widely used in various applications due to their simple design, low cost and simple control scheme. A motor cross section of a single-phase induction motor is shown in **Figure 2**. The motor consists of a stator and a rotor. The rotor consists of a mechanical assembly known as a 'squirrel cage' in most designs, and the stator consists of two windings. The main and auxiliary windings on the stator are spatially displaced by 90 degrees. The auxiliary winding has a capacitor in series with it (**Figure 3**). The capacitor allows the current in the auxiliary winding to be approximately 90 degrees out-of-phase from the current in the main winding.

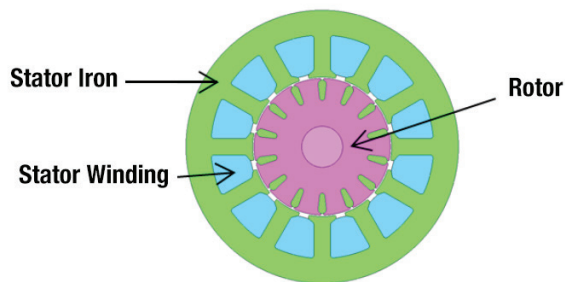

Figure 2: Single-phase induction motor example cross section

The phase shift between currents in the main and auxiliary windings results in a rotating magnetic field in the air gap, which induces currents in the rotor causing a rotor magnetic field enabling torque generation.

The equivalent circuit for the single-phase induction motor (SPIM) (**Figure 4, Figure 5**) is based on the double revolving magnetic field theory with iron losses. Both windings in the SPIM contribute towards two magnetic fields in the air gap. While one magnetic field moves in the forward direction, the other moves in the opposite direction. Hence, the equivalent circuit model of each winding consists of a forward and a reverse component.

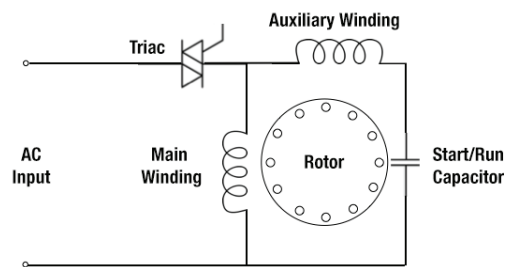

Figure 3: Capacitor start/run single-phase induction motor drive [1]

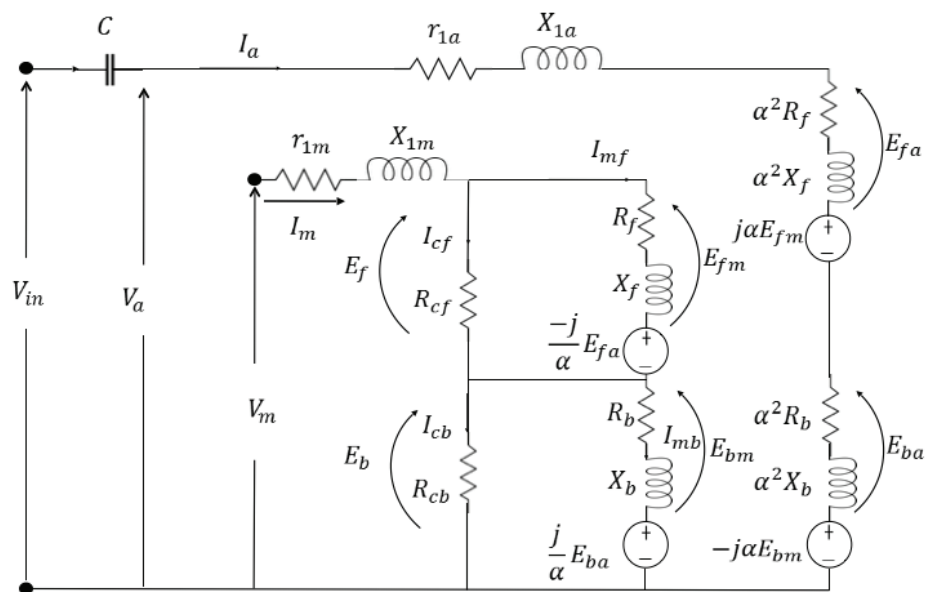

Figure 4: Equivalent circuit model for a SPIM [3]

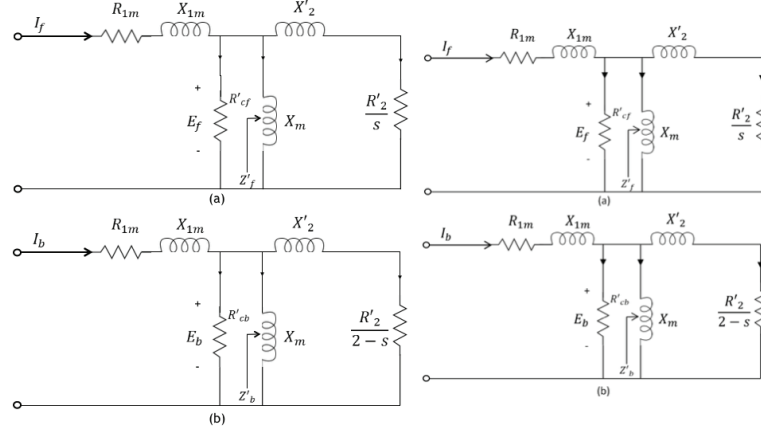

Figure 5: Equivalent circuit for SPIM forward (a) and backward (b) components [3]

As these magnetic fields rotate in opposite directions they cause higher torque ripple, resulting in vibration and noise in SPIMs. Typically, the auxiliary winding and the main winding are connected in parallel to each other (equations 1-6):

$$(1) \mathbf{V}_m = \mathbf{E}_m + \mathbf{I}_m (r_{1m} + jX_{1m})$$

$$(2) \mathbf{V}_a = \mathbf{E}_a + \mathbf{I}_a (r_{1a} + jX_{1a})$$

$$(3) \mathbf{E}_m = \mathbf{E}_f + \mathbf{E}_b$$

$$(4) \mathbf{E}_a = j\alpha \mathbf{E}_f - j\alpha \mathbf{E}_b$$

$$(5) \alpha = \frac{N_a}{N_m}$$

$$(6) \mathbf{V}_m = \mathbf{V}_{in}$$

N_a is the number of turns in the auxiliary winding, and N_m is number of turns in the main winding.

Copper loss in the stator ($P_{Cu,St}$) is calculated as:

$$(7) P_{Cu,St} = r_{1m} I_m^2 + r_{1a} I_a^2$$

Copper loss in the rotor ($P_{Cu,R}$) is calculated as:

$$(8) P_{Cu,R} = \frac{R'_2}{2} \left\{ (I_{mf}^2 + \alpha^2 I_a^2) \frac{X_m}{|R'_2/s + jX'_2|} + (I_{mb}^2 + \alpha^2 I_a^2) \frac{X_m}{|R'_2/(2-s) + jX'_2|} \right\}$$

Iron loss (P_{Fe}) in the motor is calculated as:

$$(9) P_{Fe} = R_{cf} I_{cf}^2 + R_{cb} I_{cb}^2$$

Where, $R_{cf} = R'_{cf}/2$ and $R_{cb} = R'_{cb}/2$

The mechanical output power (P_m) is calculated as:

$$(10) P_m = 2(1-s)(R_f I_f^2 - R_b I_b^2)$$

Friction and windage loss in a motor drive system are represented as:

$$(11) P_{Fr,Wind} = T_{Fr} \omega_{Mech} + B \omega_{Mech}^2$$

Unlike a permanent magnet synchronous machine (PMSM), losses exist in the induction motor's rotor as well as the stator, regardless of the number of phases. **Figure 6** shows the flow of losses. The friction loss component is T_{Fr} and the windage loss is B .

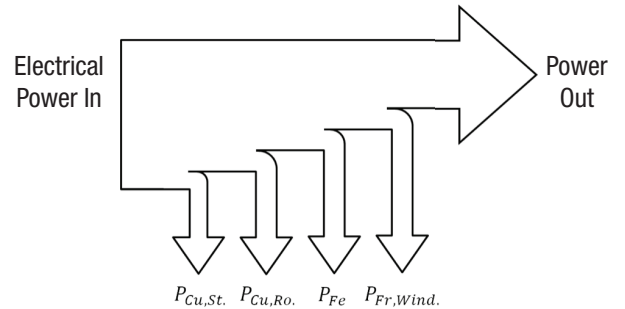

Figure 6: Losses in a single-phase induction motor [02]

Motor efficiency is quantified as (12 - 14):

$$(12) \text{ Eff.} = \frac{P_{Out}}{P_{In}} \cdot 100\%$$

$$(13) \text{ Eff.} = \frac{P_{In} - P_{Cu,St} - P_{Cu,R} - P_{Fe} - P_{Fr,Wind}}{P_{In}} \cdot 100\%$$

$$(14) \text{ Eff.} = \frac{T_{Mech} \omega_{Mech}}{V_{In} I_{In}} \cdot 100\%$$

The mechanical torque output is T_{Mech} , and the mechanical speed is ω_{Mech} .

Loss factors in three-phase IMs

Three-phase ACIMs are the work horse of the industry. Low maintenance, inexpensive design, variable-speed capability, and relatively high efficiency make the three-phase induction motor (IM) an ideal candidate for process automation.

Three-phase IMs are cost-effective in high power applications at current material market prices.

Three-phase IM variable-speed operation is achieved via an inverter stage. Typically, these inverters are equipped with soft starters and power factor correction (PFC) stages to maintain line power quality.

A three-phase ACIM cross section is shown in **Figure 7**. The equivalent circuit model is shown (per phase) in **Figure 8**. Similar to a single-phase IM, the three-phase IM also has stator and rotor windings. Generally, the rotor is made up of a cast 'squirrel cage' type structure. Additionally, the energy conversion principal of a three-phase ACIM is similar to a SPIM. The three-phase ACIM stator consists of a winding arrangement that generates a rotating magnetomotive force (MMF), when three-phase voltages are supplied to the motor. The result is a rotating MMF that generates the rotor field, similar to single-phase induction motor.

Rotor MMF frequency is slightly less than stator MMF speed. This difference in speed is necessary to induce a magnetic field in the rotor. This difference is defined as the slip, which increases as the load increases. Induction motors are also

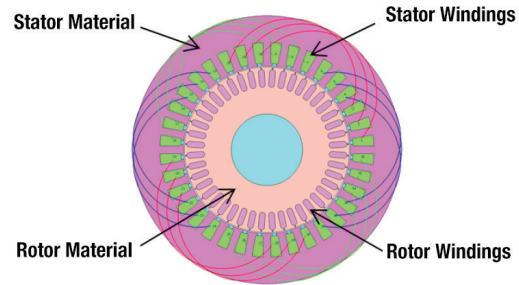

Figure 7: Example three-phase ACIM cross-section

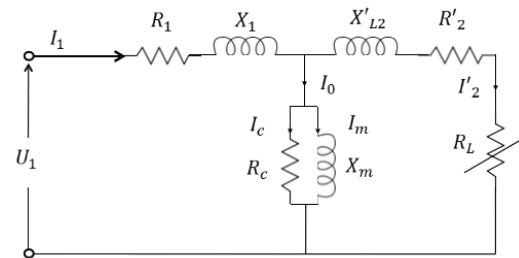

Figure 8: Per-phase equivalent circuit for a three-phase induction motor [7]

known as asynchronous machines because of the difference in the rotor and stator MMF speeds.

Rotating MMF speed is a function of the stator winding current frequency. Now a variable frequency drive is able to control the motor speed by varying the electrical frequency of the applied voltage. In the case of a speed control application, the mechanical speed can be approximated only by knowing the electrical frequency due to slip. An additional speed sensor is necessary for an induction motor, if accurate speed regulation is required.

Losses that occur in a three-phase induction motor are approximated based on the equivalent circuit model (**equations 15-17**):

Air gap power:

$$(15) P_{ag} = \frac{3}{2} \frac{I_2'^2 R_2'}{s}$$

Stator copper loss:

$$(16) P_{Cu,St} = \frac{3}{2} I_1^2 R_1$$

Rotor copper loss:

$$(17) P_{Cu,R} = \frac{3}{2} I_2'^2 R_2'$$

Iron losses are caused by eddy current losses, and hysteresis losses are characterized as: [6]

$$(18) P_{Fe} = P_{Hyst} + P_{Eddy} = k_h B^\beta \omega_1 m_s + k_e B^2 \omega_1^2 m_s$$

Where k_h and k_e are hysteresis and eddy current constants is the Steinmetz constant. B is flux density in Tesla. The magnetic field frequency in radian per second is ω_1 , and the mass of the stator iron core in kilograms is m_s .

$$(19) P_{Fe} = \frac{3 \omega_1^2 L \mu}{2 R_{Fe}}$$

In the latter form (**equation 19**), iron losses are expressed as a resistance parallel to the magnetizing inductance. Friction and windage loss in a motor drive system are represented as:

$$(20) P_{Fr,Wind} = T_{Fr} \omega_{Mech} + B \omega_{Mech}^2$$

Where input power is calculated as:

$$(21) P_{In} = \frac{3}{2} \frac{V_L I_L \cos(\theta)}{\sqrt{3}}$$

The power delivered to the load is P_{Out} . Total power flow from input to output is:

$$(22) P_{in} = P_{Cu,St} + P_{Cu,R} + P_{Fe} + P_{Fr,Wind} + P_{Out}$$

Motor efficiency is quantified as **equations 23-25**:

$$(23) Eff. = \frac{P_{Out}}{P_{In}} \cdot 100\%$$

$$(24) Eff. = \frac{P_{In} - P_{Cu,St} - P_{Cu,R} - P_{Fe} - P_{Fr,Wind}}{P_{In}} \cdot 100\%$$

$$(25) Eff. = \frac{T_{Mech} \omega_{Mech}}{V_{in} I_{In}} \cdot 100\%$$

An induction motor, regardless of three-phase or single-phase, needs to induce a magnetic field in the rotor, which consists of a wound rotor or squirrel cage type. The magnetic field in the rotor is generated by the circulating currents in the rotor, resulting from the rotating electromagnetic field from the stator. Hence, in an induction motor, copper loss or I^2R loss occurs both in the rotor and stator.

Loss factors in three-phase brushless DC motors

Brushless DC machines are a type of synchronous motor where the rotor magnetic field is generated by a set of permanent magnets. These vary from single-phase BLDC to multiphase BLDC, with a variety of rotor and stator designs. In this paper our focus is on a three-phase BLDC motor topology. Brushless DC motors are also known as permanent magnet synchronous machines (PMSMs). Two major types of PMSMs are shown in **Figure 9**. The image on the left illustrates the PMSM cross-section with surface-mounted magnets (SM-PMSM), and the image on the right shows a PMSM with interior permanent magnets (IPMSM).

Interior permanent magnet synchronous machines facilitate the generation of reluctance torque, due to the variation in inductance with respect to rotor position.

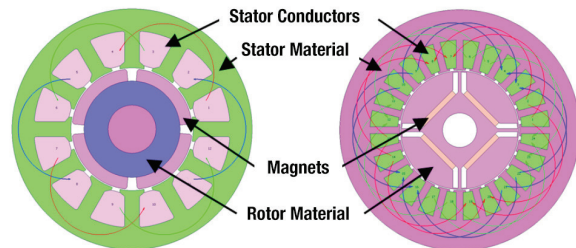

Figure 9: Example of three-phase BLDC motor cross-section: SM-PMSM (left); IPMSM (right)

The BLDC motor is a synchronous motor. Unlike the induction motor, there is no slippage between the stator and rotor fields. The stator windings of a BLDC generate a rotating MMF when supplied with a three-phase voltage. The rotor magnetic field rotates synchronously with the stator field.

The typical equivalent circuit model for a BLDC/PMSM is presented in the rotor reference frame (**Figure 10**), or also known as the synchronous reference frame. In a subsequent section, we present the rotor reference frame equivalent circuit model of a balanced BLDC motor.

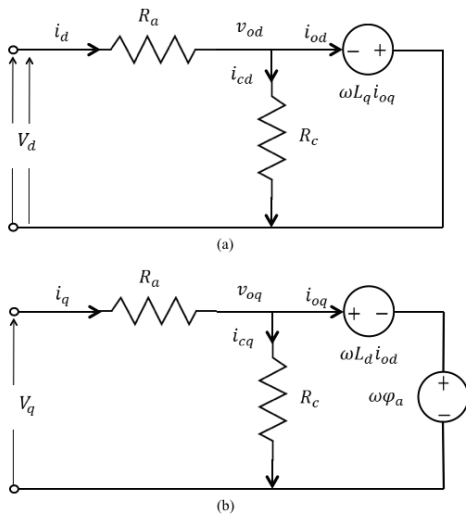

Figure 10: Rotor reference frame loss model of a BLDC motor

Copper ($P_{Cu,St}$) and iron losses (P_{Iron}) are the two main forms of loss for a three-phase BLDC motor (**equations 26-27**):

$$(26) P_{Cu,St} = R_a (i_d^2 + i_q^2)$$

$$(27) P_{Iron} = R_c (i_{cd}^2 + i_{cq}^2)$$

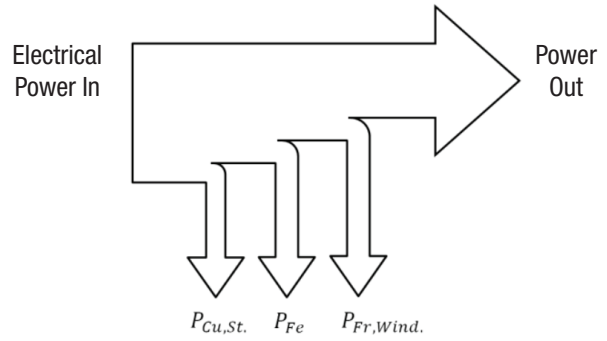

Figure 11: Power flow diagram of a brushless DC motor

Mechanical power loss is calculated as:

$$(28) P_{Fr,Wind} = T_{Fr} \omega_{Mech} + B \omega_{Mech}^2$$

P_{Out} is the power delivered to the load **Figure 11**.

Total power flow from input to output is calculated as:

$$(29) P_{in} = P_{Cu,St} + P_{Fe} + P_{Fr,Wind} + P_{Out}$$

Motor efficiency is quantified as equations 30-33:

$$(30) Eff. = \frac{P_{Out}}{P_{In}} \cdot 100\%$$

$$(31) Eff. = \frac{P_{In} - P_{Cu,St} - P_{Fe} - P_{Fr,Wind}}{P_{In}} \cdot 100\%$$

$$(32) Eff. = \frac{T_{Mech} \omega_{Mech}}{V_{In} I_{In}} \cdot 100\%$$

It is worth reiterating that unlike induction motors, there is no copper loss in the rotor as the rotor magnetic field is generated by permanent magnets.

Advantages and disadvantages of motor technologies

Depending on the fan application, a different type of motor can be used. Selection is based on the requirements of each system solution. Market studies by academic researchers [1, 2] show that the line-driven capacitor start-run, single-phase induction motors dominate the ventilation fan market. The lack of suitable permanent magnets and lower system-level cost has been the primary reason for choosing single-phase induction motors for ventilation fan solutions. We presented the motor model and loss components for single-phase induction motors, three-phase induction motors, and three-phase brushless DC motors. Here we compare each motor type and their suitability for ventilation fan applications followed by a summary of case studies:

- line driven, capacitor start-run, single-phase induction motor
- low voltage, capacitor start-run, single-phase induction motor
- high-voltage, three-phase induction motor
- high-voltage, three-phase brushless DC motor
- low-voltage, three-phase brushless DC Motor

Compared to single-phase IMs, three-phase IMs at this power level are disadvantageous due to machine losses (rotor and stator losses), switching losses in the three-phase inverter, and cost of motor material and drive stage. In an IM the energy required to generate the rotor magnetic field is transferred

from the stator, which results in increased copper losses in the stator as well as the rotor. Therefore, a brushless DC motor inherently has an advantage over an IM in terms of efficiency.

Low-voltage IMs increase losses further due to increased operating current at a particular torque-speed point. A line-voltage, inverter-fed, three-phase IM requires a stable DC bus voltage and an inverter stage. An inverter stage increases cost, with little improvement in efficiency as the losses incurred in the process of generating the rotor magnetic field remains. A high-voltage BLDC motor requires the same inverter stage, but provides better efficiency performance compared to induction motor solutions. The capacitor in series with the auxiliary winding in a single-phase induction motor poses a reliability concern with prolonged operation.

In considering low-power applications (less than 100W), a high-voltage BLDC motor requires a higher back electromotive force (EMF) constant. Several factors impact the back EMF constant. Magnet strength is a key factor. Therefore, high-voltage BLDC applications may require using stronger magnets, but at a cost penalty. This cost penalty may be averted by using less expensive Ferrite magnets and a lower bus voltage. Lower bus voltages also help reduce DC bus capacitor cost. But the system now requires a voltage step-down scheme, if operated by the AC line voltage. Each system solution must be carefully evaluated on a case-by-case basis in order to obtain the best system-level performance and cost benefits.

Case Study: Three-phase, variable-frequency PMSM analysis with single-phase IM in household appliances

This case study is a summary of reference [10] where we highlight the experimental data comparing efficiency and power factor between a single-phase ACIM system and a three-phase BLDC system.

The SPIM and BLDC motor of choice have the same core length. Yet the BLDC power density is higher compared to that of the SPIM. The BLDC motor is rated for 80V and the SPIM is rated at 220V.

	Single-phase induction motor	Three-phase BLDC motor
Rated power (kW)	1.5	2.2
Rated speed (RPM)	1400	1500
Rated voltage (V)	220	80
Rated current (A)	10.5	10.12
Phases	1	3
Poles	4	4
Rated torque (Nm)	10	14

Table 1. Motor specifications*

*Copyright © IEEE. All rights reserved. Reprinted, with permission, from [10]. Personal use of this material is permitted. However, permission to reuse this material for any other purpose must be obtained from the IEEE.

Load rate	Single-phase induction motor		Three-phase BLDC motor	
	Efficiency	P.F.	Efficiency	P.F.
20%	48.7%	0.550	76.2%	0.776
40%	68.7%	0.615	89.2%	0.867
60%	75.7%	0.702	90.4%	0.905
80%	79.6%	0.860	90.5%	0.947
100%	80.8%	0.930	90.8%	0.973

Table 2. Performance comparison*

*Copyright © IEEE. All rights reserved. Reprinted, with permission, from [10]. Personal use of this material is permitted. However, permission to reuse this material for any other purpose must be obtained from the IEEE.

A detailed summary of the motor specifications are presented in **Table 1**.

A series of tests were conducted by the authors of reference [10] as well as ourselves to evaluate the performance of each motor. The efficiency and power factor at different load conditions are in **Table 2** and **Figures 12, 13**. We do not present the exact operating point in terms of torque and speed. Therefore, assume that each motor was driven in open-loop mode, and the load applied from the dynamometer was varied between operating points to obtain the efficiency and the power factor.

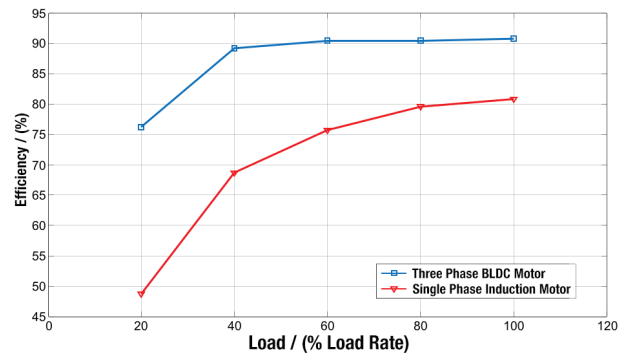

Figure 12: Efficiency comparison*

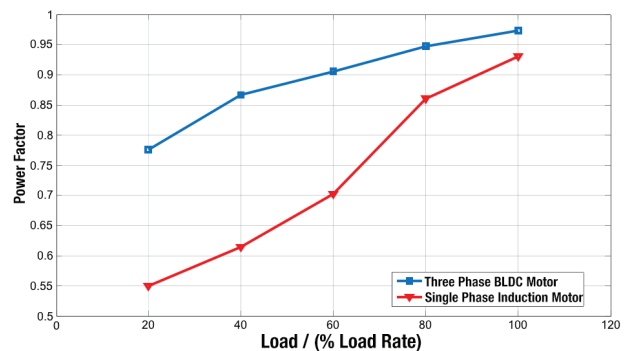

Figure 13: Power factor comparison*

Case Study 2: Data collected with fan motors

Data provided in the first case study are for motors with a larger than 1 kW power rating. In the second case study, we collected data with single-phase ACIM fans and three-phase BLDC fans that are less than 100W.

A load curve for a specific fan design is unique and is a function of the mechanical speed. To ensure equivalent loading, both motors ran at the same mechanical speed and with the same fan blades (Figure 14). The single-phase ACIM used a start-run capacitor drive topology (110V AC), whereas the BLDC motor speed was varied electronically (three-phase inverter-based average voltage control at 24V DC). Power data was collected with a Yokogawa® WT1800 power analyzer. Collected data



Figure 14: Three-phase BLDC motor with fan blades used in the experiment

are shown in Table 3, Figure 15. Table 04, Figure 16 shows total energy consumed by each system if operated at the chosen speed: two hours a day for 365 days.

	Single-phase induction motor	Three-phase BLDC motor
Speed (RPM)	Power (W)	Power (W)
415	18.2	5.15
715	54.50	23.44
890	71.17	47.37

Table 3. Comparison of power consumed by single-phase AC induction motor (SPACIM) fan and three-phase BLDC fan

	Single-phase induction motor	Three-phase BLDC motor	Annual energy savings with BLDC / kWh
Speed (RPM)	Energy (kWh)	Energy (kWh)	
415	18.2	5.15	9.53
715	54.50	23.44	22.67
890	71.17	47.37	17.37

Table 4. Comparison of annual energy consumption of a use case

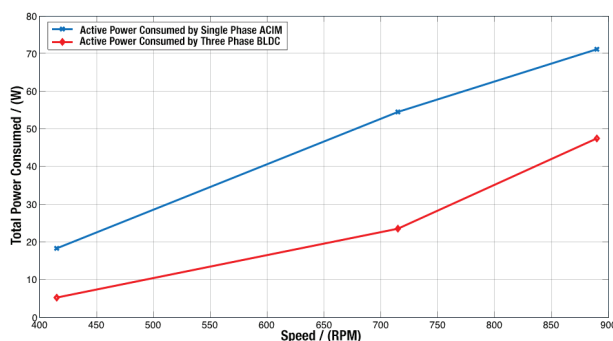

Figure 15: Comparison of power consumption between single-phase AC induction motor versus three-phase BLDC motor

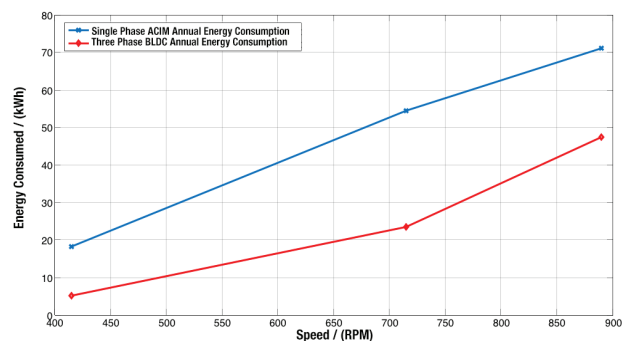

Figure 16: Comparison of annual energy consumption between single-phase AC induction motor versus three-phase BLDC motor-based on the selected use case (two hours per day for 365 days)

Conclusions

Increasing energy cost and environmental concerns are demanding system efficiency. Electromechanical energy conversion is a major use of energy in both industrial and residential sector. Electric motors are the main form of electromechanical energy conversion. Hence, an efficient form of energy conversion reduces energy cost and the environmental impact. Historically, the induction motor was a favorable solution as ceramic magnets were not a cost-effective solution to generate a strong magnetic field for energy conversion. But advancements in magnetic material are enabling cost-effective BLDC solutions that out-perform induction motors. BLDC motors have been shown to provide better efficiency compared to single-phase induction motors.

In this paper we provide an equivalent circuit model-based machine loss analysis as well as experimental data to justify efficiency improvement achievable

with BLDC motors, compared to single-phase induction motors. Data shows that BLDC motors may improve your efficiency as much as 3.5 times that of a single-phase induction motor. Additionally, in variable speed applications BLDC motors with a variable frequency drive, use less active material compared to a variable frequency drive-driven, induction motor [12].

This approach is advantageous as overall BLDC motor-based systems will be compact and lighter.

Different governing bodies across different parts of the world have provided guidelines for motor system efficiency for a range of applications. IEC and NEMA are some of those governing bodies. In considering the efficiency requirements and performance criterion, a brushless DC motor solution is superior in-terms of performance and efficiency compared to induction motors.

References

1. A.E. Fitzgerald, C. Kingsley Jr., S.D. Umans, "Single and Two-Phase Motors," Electric Machinery, 6th ed. McGraw-Hill.
2. Fuchs, E.F.; Vandenput, A.J.; Holl, J.; White, J.C., "Design analysis of capacitor-start, capacitor-run single-phase induction motors," Energy Conversion, IEEE Transactions, vol.5, no.2, pp.327-336, Jun 1990.
3. Vaez-Zadeh, S.; Zahedi, B., "A Steady State Model Including Iron loss for Variable Speed Single-Phase Induction Motors," Power Electronics Specialists Conference, 2007. PESC 2007. IEEE, vol., no., pp.606-611, 17-21 June 2007.
4. T.J.E. Miller, "Brushless Permanent-Magnet and Reluctance Motor Drives," Oxford Science Publications. 1989.
5. Ozcelik, N.G.; Dogru, U.E.; Ergene, L.T., "Comparison study of drive motors for cooker hood applications," Power Electronics and Motion Control Conference and Exposition (PEMC), 2014 16th International, vol., no., pp.1252-1258, 21-24 Sept. 2014.
6. Stanislav, F.; Jan, B.; Jiri, L., "Analytical derivation of induction machine efficiency map," Power Engineering, Energy and Electrical Drives (POWERENG), 2013 Fourth International Conference, vol., no., pp.1206-1210, 13-17 May 2013.
7. Guemes, J.A.; del Hoyo, J.I., "On-load modelling of three-phase induction motors. A new method for determination of the rated current and equivalent circuit parameters," Industry Applications Conference, 2000. Conference Record of the 2000 IEEE, vol.1, no., pp.352-358 vol.1, 2000.
8. Feng, X.; Bao, Y.; Liu, L.; Huang, L.; Zhang, Y., "Performance investigation and comparison of Line Start-up Permanent Magnet Synchronous Motor with super premium efficiency," Electrical Machines (ICEM), 2012 XXth International Conference, vol., no., pp.424-429, 2-5 Sept. 2012.
9. Morimoto, S.; Tong, Y.; Takeda, Y.; Hirasaka, T., "Loss minimization control of permanent magnet synchronous motor drives," Industrial Electronics, IEEE Transactions, vol.41, no.5, pp.511-517, Oct 1994.
10. Guihong Feng; Wen Qi; Bingyi Zhang; Chao Li, "Analysis and comparison of three-phase variable frequency PMSM with single-phase induction motor in household appliances," Electrical Machines and Systems (ICEMS), 2011 International Conference, vol., no., pp.1-5, 20-23 Aug. 2011.
11. Martire, T.; Matt, D.; Fadar, J., "The permanent magnet synchronous motor in household appliances domain," Industrial Electronics, 2004 IEEE International Symposium, vol.2, no., pp.1231-1235 vol. 2, 4-7 May 2004.
12. de Almeida, A.T.; Ferreira, F.J.T.E.; Fong, J.A.C., "Standards for Efficiency of Electric Motors," Industry Applications Magazine, IEEE, vol.17, no.1, pp.12-19, Jan.-Feb. 2011.
13. Dalvi J., "24-V, 50W BLDC Motor Sinusoidal Drive for Air Purifier Fans," TI Designs, Oct-2015. This approach is advantageous as overall BLDC motor-based systems will be compact and lighter.

Important Notice: The products and services of Texas Instruments Incorporated and its subsidiaries described herein are sold subject to TI's standard terms and conditions of sale. Customers are advised to obtain the most current and complete information about TI products and services before placing orders. TI assumes no liability for applications assistance, customer's applications or product designs, software performance, or infringement of patents. The publication of information regarding any other company's products or services does not constitute TI's approval, warranty or endorsement thereof.

The platform bar is a trademark of Texas Instruments.
All other trademarks are the property of their respective owners.

© 2016 Texas Instruments Incorporated
Printed in the U.S.A.

IMPORTANT NOTICE

Texas Instruments Incorporated and its subsidiaries (TI) reserve the right to make corrections, enhancements, improvements and other changes to its semiconductor products and services per JESD46, latest issue, and to discontinue any product or service per JESD48, latest issue. Buyers should obtain the latest relevant information before placing orders and should verify that such information is current and complete. All semiconductor products (also referred to herein as "components") are sold subject to TI's terms and conditions of sale supplied at the time of order acknowledgment.

TI warrants performance of its components to the specifications applicable at the time of sale, in accordance with the warranty in TI's terms and conditions of sale of semiconductor products. Testing and other quality control techniques are used to the extent TI deems necessary to support this warranty. Except where mandated by applicable law, testing of all parameters of each component is not necessarily performed.

TI assumes no liability for applications assistance or the design of Buyers' products. Buyers are responsible for their products and applications using TI components. To minimize the risks associated with Buyers' products and applications, Buyers should provide adequate design and operating safeguards.

TI does not warrant or represent that any license, either express or implied, is granted under any patent right, copyright, mask work right, or other intellectual property right relating to any combination, machine, or process in which TI components or services are used. Information published by TI regarding third-party products or services does not constitute a license to use such products or services or a warranty or endorsement thereof. Use of such information may require a license from a third party under the patents or other intellectual property of the third party, or a license from TI under the patents or other intellectual property of TI.

Reproduction of significant portions of TI information in TI data books or data sheets is permissible only if reproduction is without alteration and is accompanied by all associated warranties, conditions, limitations, and notices. TI is not responsible or liable for such altered documentation. Information of third parties may be subject to additional restrictions.

Resale of TI components or services with statements different from or beyond the parameters stated by TI for that component or service voids all express and any implied warranties for the associated TI component or service and is an unfair and deceptive business practice. TI is not responsible or liable for any such statements.

Buyer acknowledges and agrees that it is solely responsible for compliance with all legal, regulatory and safety-related requirements concerning its products, and any use of TI components in its applications, notwithstanding any applications-related information or support that may be provided by TI. Buyer represents and agrees that it has all the necessary expertise to create and implement safeguards which anticipate dangerous consequences of failures, monitor failures and their consequences, lessen the likelihood of failures that might cause harm and take appropriate remedial actions. Buyer will fully indemnify TI and its representatives against any damages arising out of the use of any TI components in safety-critical applications.

In some cases, TI components may be promoted specifically to facilitate safety-related applications. With such components, TI's goal is to help enable customers to design and create their own end-product solutions that meet applicable functional safety standards and requirements. Nonetheless, such components are subject to these terms.

No TI components are authorized for use in FDA Class III (or similar life-critical medical equipment) unless authorized officers of the parties have executed a special agreement specifically governing such use.

Only those TI components which TI has specifically designated as military grade or "enhanced plastic" are designed and intended for use in military/aerospace applications or environments. Buyer acknowledges and agrees that any military or aerospace use of TI components which have **not** been so designated is solely at the Buyer's risk, and that Buyer is solely responsible for compliance with all legal and regulatory requirements in connection with such use.

TI has specifically designated certain components as meeting ISO/TS16949 requirements, mainly for automotive use. In any case of use of non-designated products, TI will not be responsible for any failure to meet ISO/TS16949.

Products

Audio	www.ti.com/audio
Amplifiers	amplifier.ti.com
Data Converters	dataconverter.ti.com
DLP® Products	www.dlp.com
DSP	dsp.ti.com
Clocks and Timers	www.ti.com/clocks
Interface	interface.ti.com
Logic	logic.ti.com
Power Mgmt	power.ti.com
Microcontrollers	microcontroller.ti.com
RFID	www.ti-rfid.com
OMAP Applications Processors	www.ti.com/omap
Wireless Connectivity	www.ti.com/wirelessconnectivity

Applications

Automotive and Transportation	www.ti.com/automotive
Communications and Telecom	www.ti.com/communications
Computers and Peripherals	www.ti.com/computers
Consumer Electronics	www.ti.com/consumer-apps
Energy and Lighting	www.ti.com/energy
Industrial	www.ti.com/industrial
Medical	www.ti.com/medical
Security	www.ti.com/security
Space, Avionics and Defense	www.ti.com/space-avionics-defense
Video and Imaging	www.ti.com/video

TI E2E Community

e2e.ti.com