

# **Linear Repeaters Used in SAS/SATA Applications**

Lee Sledjeski

## **ABSTRACT**

This report summarizes the results of SAS/SATA testing using TI's DS125BR820 and DS125BR401A Low-Power 12.5 Gbps 8-Channel Repeaters. The TI devices are tested in an external miniSAS-HD environment and directly using a DS125BR820EVM. The test results will demonstrate how linear equalization can improve system margin and allow for the extended channel configurations that are required in the latest storage systems.

## **Contents**

1	Introduction .....	2
2	SAS-3 Transmit Waveforms .....	2
3	Equalizer Placement within a SAS-3 Channel .....	5
4	System Results Using Linear Equalization .....	7
5	Passing Out Of Band (OOB) Signals .....	10
6	Conclusions .....	12
7	Appendix A: Layout Considerations .....	12

## **List of Figures**

1	Typical Application Using the DS125BR820 .....	2
2	Typical Host Transmitter Reference Waveforms .....	3
3	Transmitted and Recovered SAS-3 Waveforms .....	4
4	Waveforms Before and After a Linear Equalizer .....	5
5	Illustration of Channel Extension and DS125BR820 Placement .....	6
6	Waveforms at the SAS-3 Tx and After the Linear Equalizer .....	7
7	SAS-3 System Test Setup .....	7
8	TIDA-00425, 12 Gbps SAS-3 Link Extender Board .....	8
9	12 Gbps SAS-3 Waveform Output from "Link Extender Board" .....	9
10	12 Gbps SAS-3 Testing with System ASIC .....	10
11	OOB Signaling at DS125BR820 Input .....	11
12	OOB Signaling at DS125BR820 Output .....	11
13	Evaluation Module Layout Using the DS125BR820 .....	13
14	AC Coupling Capacitor Footprint Relief .....	14

## **List of Tables**

1	SAS-3 Transmitter Equalization .....	2
2	SAS-3 Reference Waveform Characteristics .....	3
3	DS125BR820 Settings Used for Testing .....	6
4	DS125BR401A Settings Used for Testing .....	8
5	OOB Specifications .....	10

## Trademarks

### 1 Introduction

The testing carried out in this report involves the DS125BR820 Low-Power 12.5Gbps 8-Channel Linear Repeater which is designed to support 40GbE (40G-CR4/KR4/SR4/LR4), SAS/SATA, and PCIe Gen 3.0 applications. The linear nature of the DS125BR820's equalization allows the DS125BR820 to preserve the transmit signal characteristics of the system ASIC, thereby allowing the link partners to negotiate transmit equalizer coefficients.

The DS125BR820 is in a small 10mm x 5.5mm leadless WQFN package, which fits easily behind a standard miniSAS-HD connector.

A typical SAS application of the DS125BR820 is shown in [Figure 1](#).

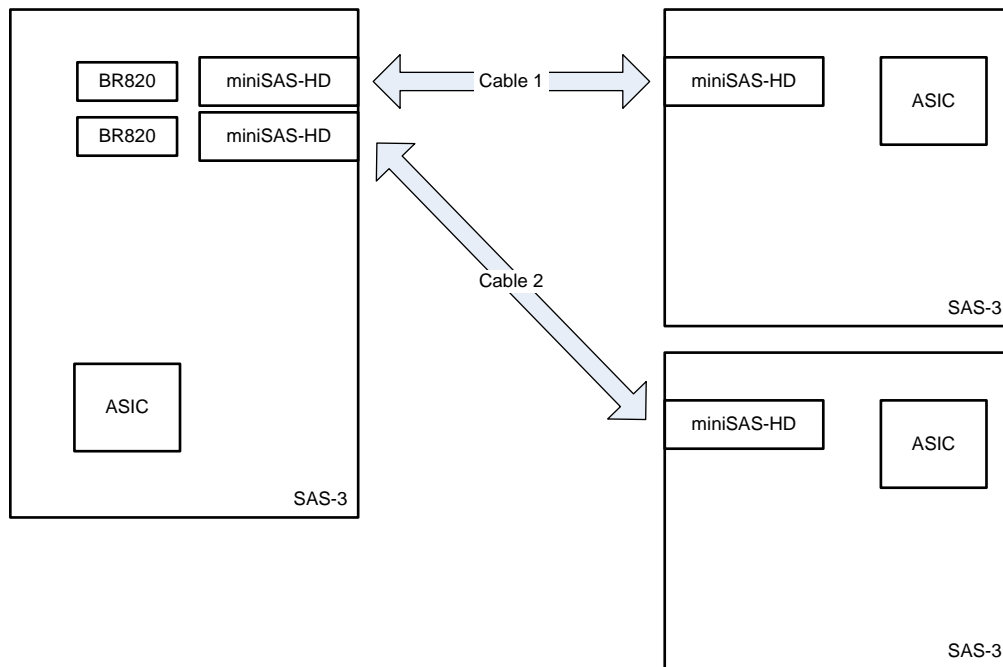

**Figure 1. Typical Application Using the DS125BR820**

### 2 SAS-3 Transmit Waveforms

SAS-3 is a serial interface which is often grouped in a x4 lane arrangement supported by miniSAS-HD connectors. Due to the link attenuation supported by SAS-3 devices, the SAS-3 transmitter must contribute some Tx equalization to help compensate for the total channel attenuation or loss at high frequencies. The transmitter must be able to produce individual pre- and post- cursor equalization coefficients based on the table below.

**Table 1. SAS-3 Transmitter Equalization**

SIGNAL CHARACTERISTIC	MINIMUM	NOMINAL	MAXIMUM	UNITS
Precursor Equalization Ratio $R_{PRE}$	1		1.66	V/V
Post Cursor Equalization Ratio $R_{POST}$	1		3.33	V/V
Peak to Peak Voltage (Differential $V_{p,p}$ )	850		1200	mV
Transmitter Device Off Voltage			50	mV

**NOTE:** When pre- and post-cursor energy is applied, the combined equalization may be higher.

The experiments in this report demonstrate the DS125BR820's ability to reproduce this type of transmitted waveform using active continuous time linear equalization. This capability works well with system Tx-Rx training algorithms, allowing for increased reach in SAS-3 applications.

### 2.1 Default Transmit Equalization Coefficients

SAS-3 defines a pair of Reference waveforms, Reference 1 (left side) and Reference 2 (right side). In many cases Reference 1 is used as a starting point for link training.

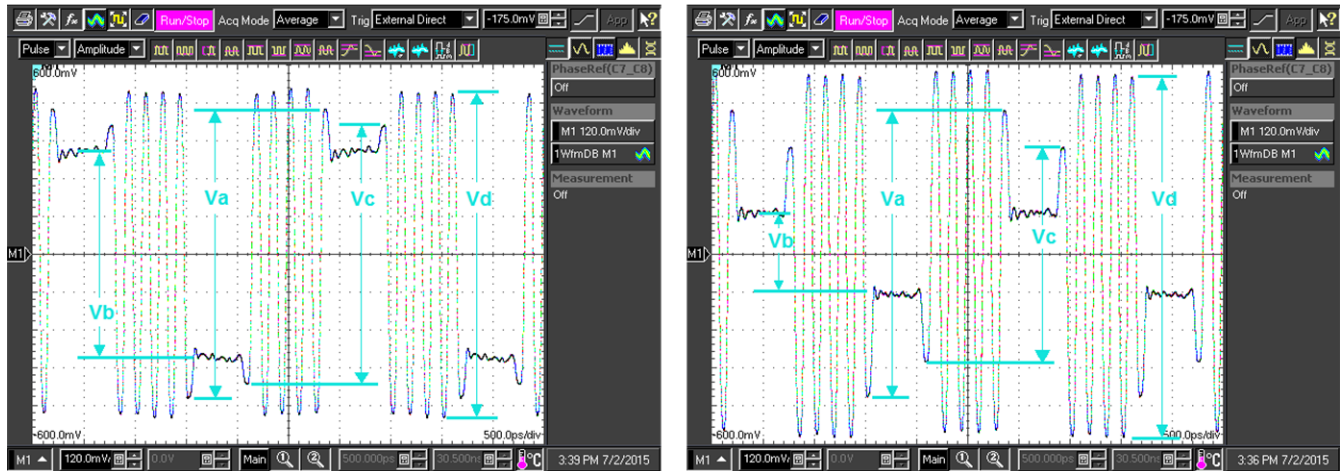

Figure 2. Typical Host Transmitter Reference Waveforms

The voltage specifications for Reference 1 and Reference 2 waveforms are listed in Table 2.

Table 2. SAS-3 Reference Waveform Characteristics

WAVEFORM	Va	Vb	Vc	Vd	Va/Vb	Vc/Vb	POST CURSOR	PRE CURSOR
Reference 1	1.03	0.725	0.915	1.20	1.42	1.262	-3 dB	2 dB
Reference 2	0.84	0.23	0.61	1.20	3.65	2.652	-11.2 dB	8.5 dB
No Tx Eq	1.20	1.20	1.20	1.20	1	1	0 dB	0 dB

### 2.2 Using Linear Equalization to Recover Tx FIR Information

Tx equalization or Tx Finite Impulse Response (FIR) is used in SAS-3 to assist the SAS-3 receiver in establishing a robust communication link across the system interface. When the system is physically large and the serial data-rate is increased, there is going to be an increase in the overall attenuation or loss present in the transmit channel. Since the SAS-3 specification utilizes a Rx – Tx training algorithm to optimize the overall equalization solution, it is important that any intermediate component provide a linear response. Keeping the whole system relatively linear enables the SAS-3 transmit signals to reach through the linear equalizer and make an impact on the SAS-3 receiver eye opening. Without this linear behavior the training process is likely to result in sub-optimal solutions.

In order to demonstrate the linear nature of the DS125BR820, a transmit waveform with TX FIR energy was observed. Placing the DS125BR820 within the active channel at a point 8 dB removed from the SAS-3 transmitter output shows how linear equalization can recover high frequency energy lost due to attenuation and retain critical low frequency information as well. This preserves the transmitted waveform analog characteristics.

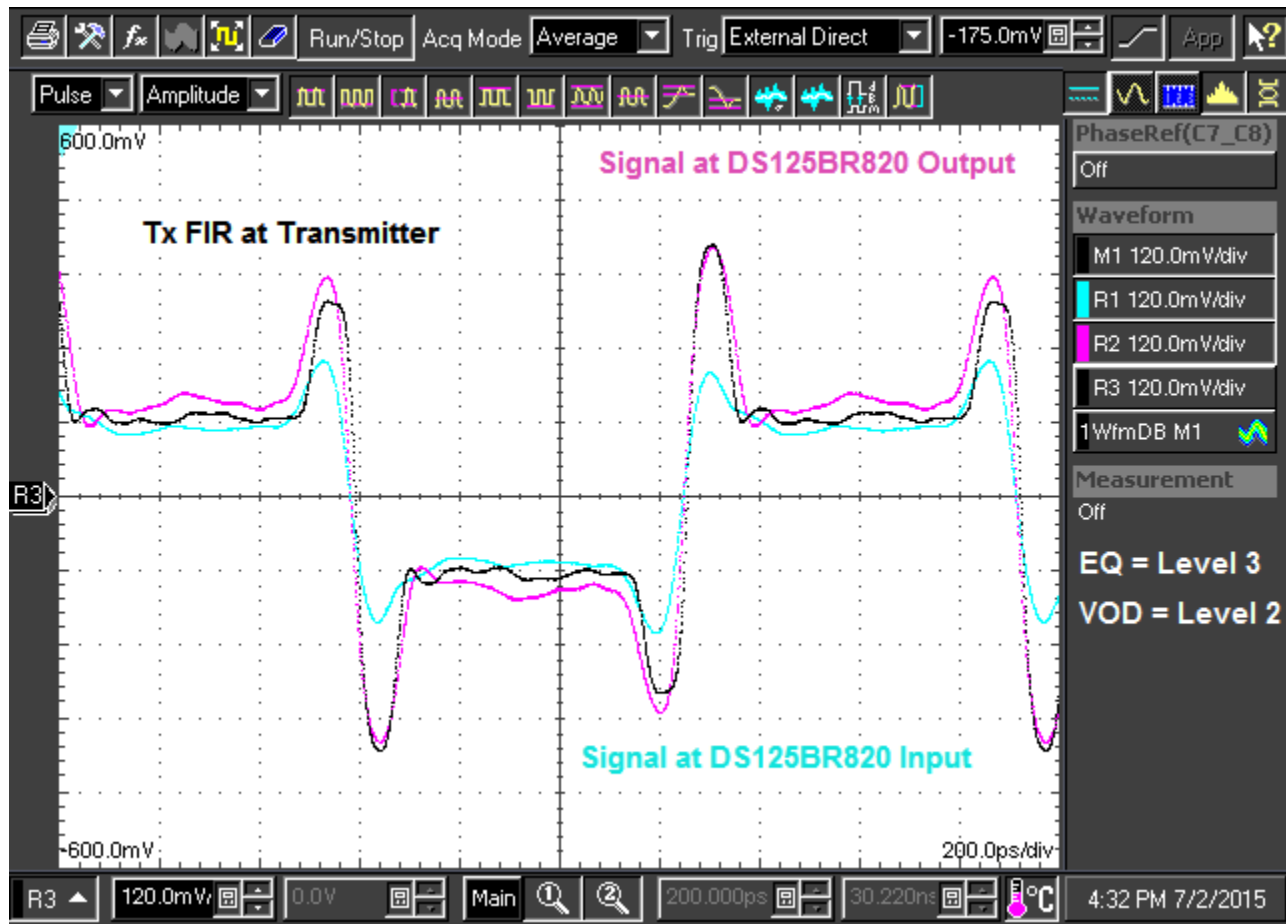

Figure 3. Transmitted and Recovered SAS-3 Waveforms

The SAS-3 Tx and equalizer input/output waveforms in Figure 3 are aligned in time. Much of the original Tx information has been lost due to attenuation (Light Blue Waveform). Linear equalization on the DS125BR820 output (Magenta Waveform) is still able to recover and reproduce the analog characteristics of the original FIR Tx waveform (Black Waveform).

### 2.3 Linear Equalization Effects on Jitter Due to Attenuation

A key benefit of linear equalization is how it can have a positive impact further down the channel after significant energy has been attenuated away from the initial transmit signal. By moving the point of linear equalization 14" from the SAS-3 transmitter it is easy to see just how much jitter accumulates after only ~ 14 dB of attenuation at 6 GHz. When combined with a typical Reference 1 waveform, the DS125BR820 significantly improves the eye opening and reduces jitter. This is shown in Figure 4.

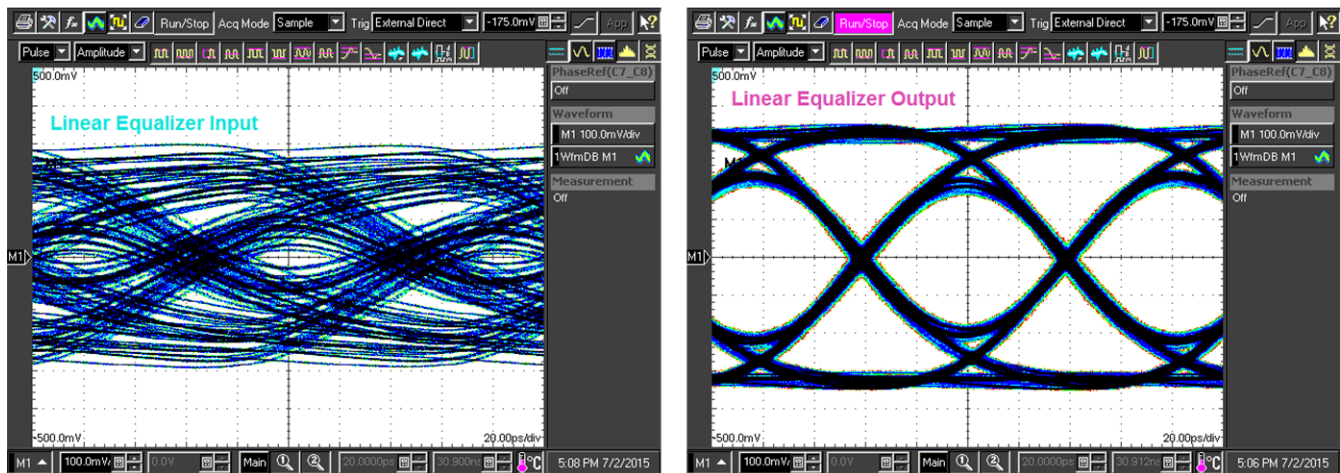

Figure 4. Waveforms Before and After a Linear Equalizer

The combination of Expander package, transmission line traces, and vias can easily add up to a total attenuation of 10-12 dB when connecting a SAS Expander to a set of external miniSAS-HD connectors.

### 3 Equalizer Placement within a SAS-3 Channel

The benefits of a linear equalizer can only be realized if it is placed some distance away from the SAS-3 transmitter. The physical distance may vary based on materials used in PCB fabrication, but not the attenuation. Since linear equalizers compensate for PCB or cable based attenuation, some attenuation must occur prior to the equalizer to result in any benefit. Figure 5 helps to show the minimum input loss required to optimize the possible channel extension. As the level of equalization in the DS125BR820 is increased, the device must be placed further away from the transmit source. Using an equalization setting which can drive the DS125BR820 beyond the 1.2 V dynamic range will result in non-linear operation. This will degrade the waveform and result in sub-optimal link training results.

Placement to maximize channel extension is not limited to a location roughly 10 dB removed from the transmit source. It is possible to achieve full extension when the DS125BR820 is placed at any point beyond the 10 dB minimum. If placement closer than 10 dB from the transmitter is required, a lower level of equalization is recommended.

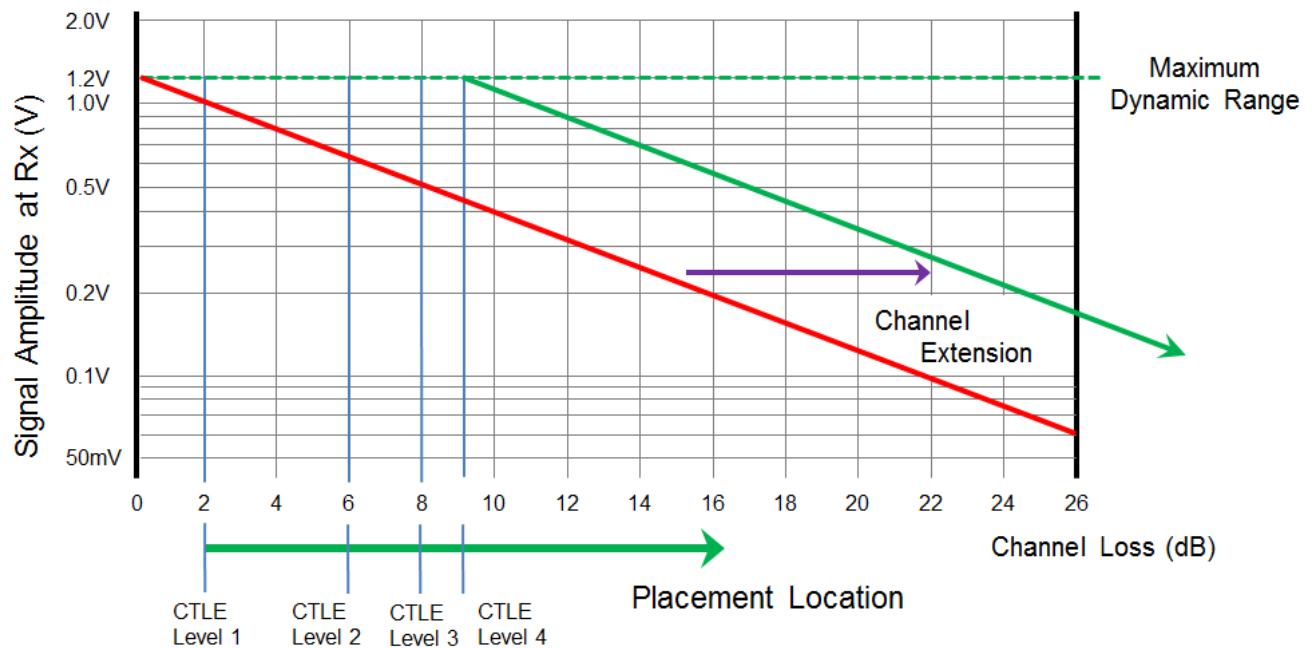
**Figure 5. Illustration of Channel Extension and DS125BR820 Placement**
**Table 3. DS125BR820 Settings Used for Testing**

EQ SETTING			OUTPUT SETTINGS		COMMENTS
VALUE	PIN STRAP	EQUIVALENT REGISTER SETTING	VOD	VOD_DB	
Level 1	0: 1 kΩ to GND	0x2C or 0x00	Level 2 - Level 6 or 0xAA – 0xAE	0 dB or 000'b	Different EQ settings used for different input channel length.
Level 2	R: 20 kΩ to GND	0x2D or 0x01			
Level 3	F: Floating	0x2E or 0x02			
Level 4	1: 1 kΩ to VIH	0x2F or 0x03			

**NOTE:** Each channel has its own EQ, VOD, and VOD\_DB control register.

## 4 System Results Using Linear Equalization

### 4.1 Linear Equalization Effects on Jitter Due to Attenuation

As shown earlier with the ability to recover and reproduce SAS-3 transmit FIR characteristics, this section shows a family of curves from the SAS-3 Transmitter and at the output of the DS125BR820 Linear Equalizer. As the SAS-3 waveform post cursor is stepped up from a minimum value (Light Blue Waveform), the DS125BR820 is able to stay in sync with the SAS-3 transmit waveform characteristics. Like waveform colors on left and right oscilloscope screens show SAS-3 Tx output and equalizer output characteristics for the same condition.

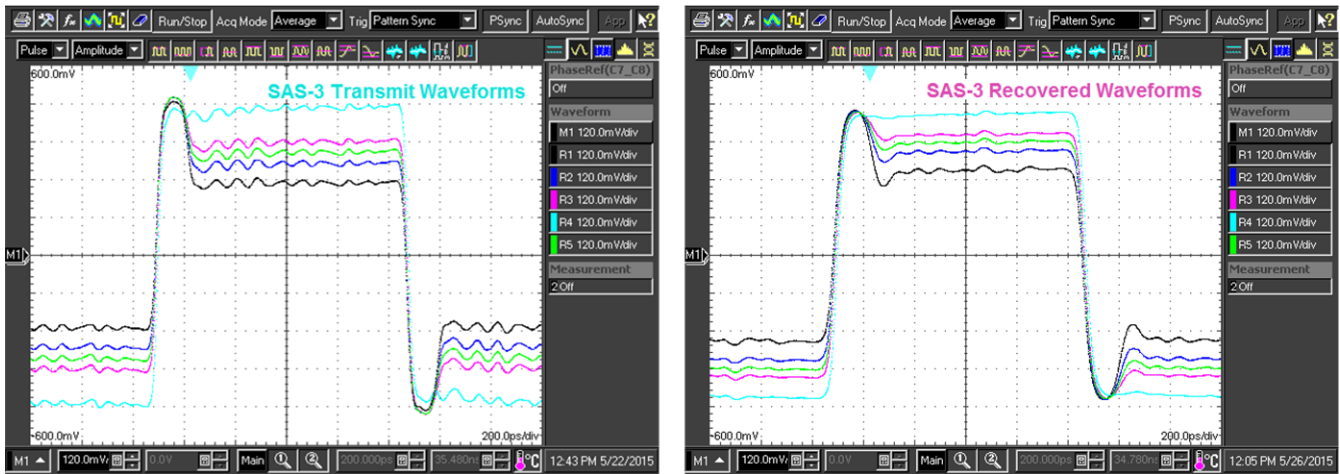

Figure 6. Waveforms at the SAS-3 Tx and After the Linear Equalizer

For this family of waveforms the linear equalizer was placed ~ 5 dB from the SAS-3 Tx. The waveforms taken at the output of the DS125BR820 utilized an equalizer setting of Level 2 (+5dB).

### 4.2 Channel Extension

In order to assess channel extension in a system environment, a PCB with the DS125BR401A and miniSAS-HD connectors was developed.

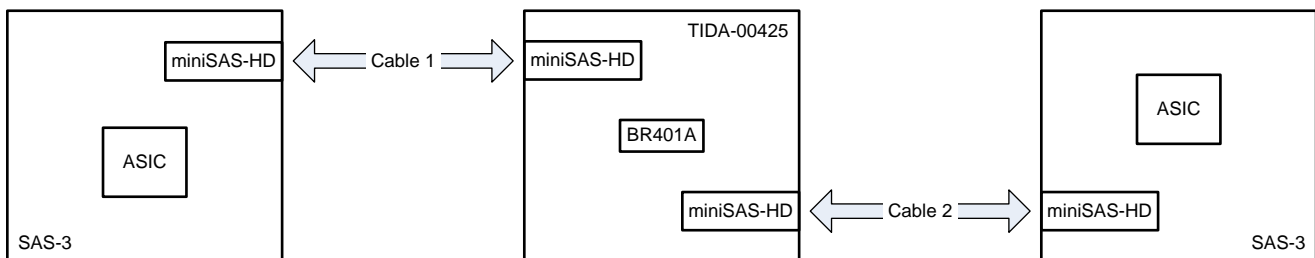

Figure 7. SAS-3 System Test Setup

The following EQ, VOD, DEM, and VOD\_DB settings have been tested for SAS-3 12 Gbps operation with a SAS-3 Expander ASIC. The cable lengths tested ranged from 1 – 12 meters with no more than 7 meters on one side of the DS125BR401A. The test data is shown in the table below.

**Table 4. DS125BR401A Settings Used for Testing**

CABLE LENGTHS		DS125BR401A SETTINGS						BER Testing Result
Cable1	Cable 2	CH-A EQ	CH-A VOD	CH-A DEM	CH-B EQ	CH-B VOD	CH-B DEM	
2m	7m	0x03'h	110'b	0x00'h	0x03'h	1.4Vpp	0x00'h	Pass
3m	7m	0x03'h	110'b	0x00'h	0x03'h	1.4Vpp	0x00'h	Pass
5m	7m	0x03'h	110'b	0x00'h	0x03'h	1.4Vpp	0x00'h	Pass
7m	2m	0x03'h	110'b	0x00'h	0x00'h	1.4Vpp	0x00'h	Pass
7m	3m	0x03'h	110'b	0x00'h	0x00'h	1.4Vpp	0x00'h	Pass
7m	5m	0x03'h	110'b	0x00'h	0x00'h	1.4Vpp	0x00'h	Pass

**NOTE:** Channel-A DEM is listed as VOD\_DB in the device datasheet.

The mini-SAS HD cable running from the system ASIC to the DS125BR401A (Table 4, Column 2) connects to the top connector on the DS125BR401A SAS board given the orientation shown in Figure 8. The mini-SAS HD cable running from the DS125BR401A to the system ASIC (Table 4, Column 4) connects to the bottom connector.

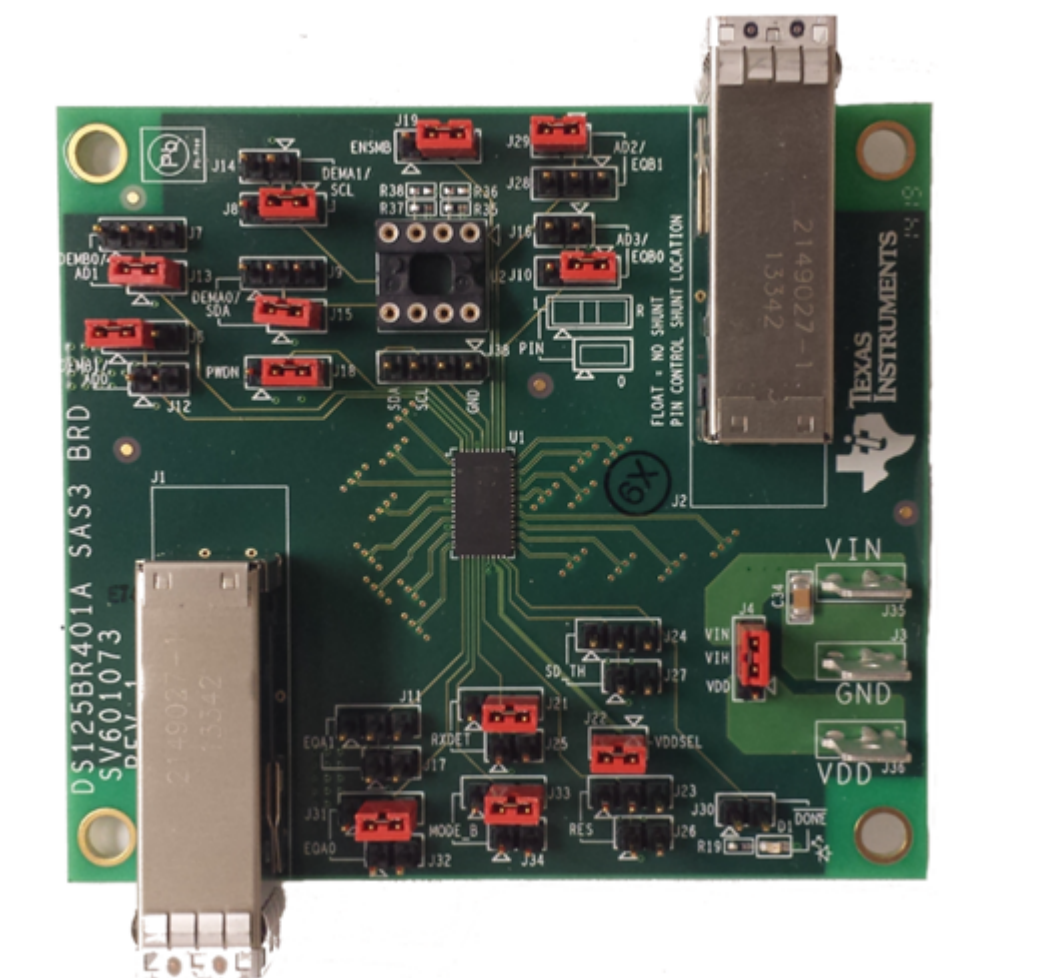

**Figure 8. TIDA-00425, 12 Gbps SAS-3 Link Extender Board**



Although testing was completed with DS124BR401A CTLE = 0x03'h for Channel A, lower levels of equalization should be used if the attenuation between the SAS-3 ASIC Tx and the DS125BR401A inputs is less than 8-10 dB at 6 GHz.

With the miniSAS-HD cables removed, the TIDA-00425 "SAS-3 Link Extender" design can be tested directly using SMA to miniSAS-HD breakout cables. Under this condition, high quality waveforms are observed on the output ports.

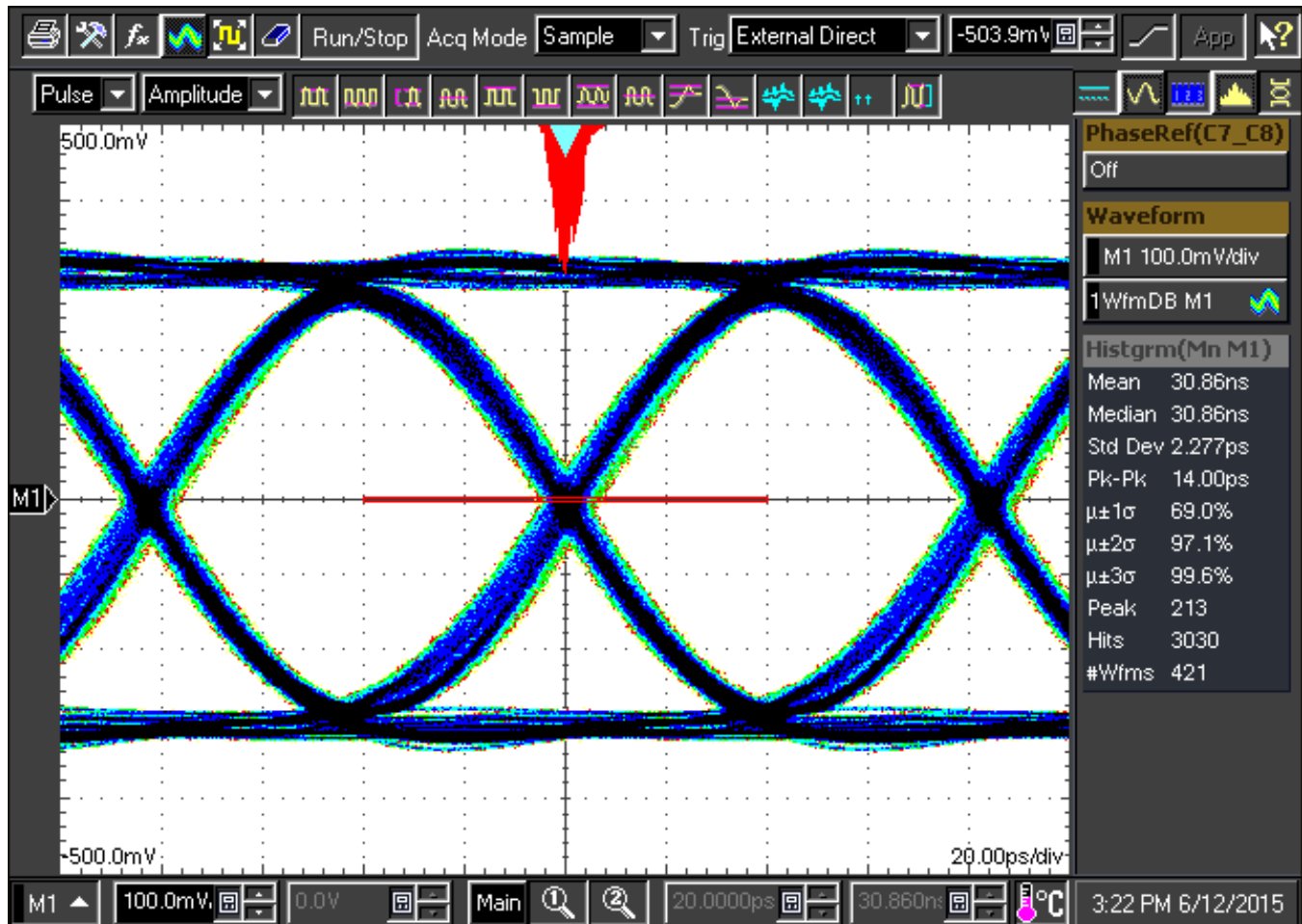
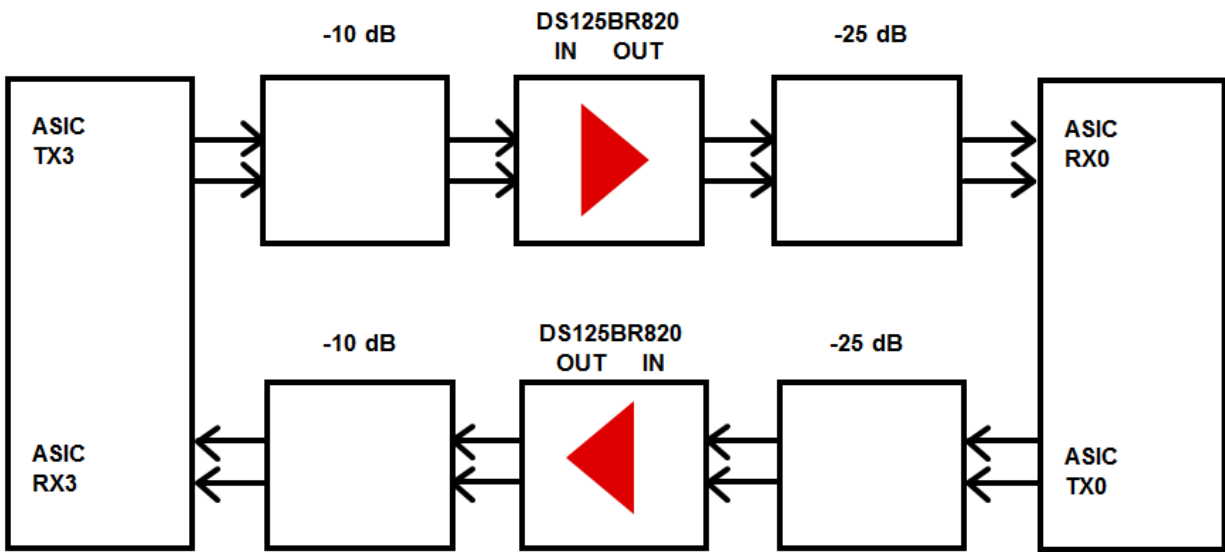

Figure 9. 12 Gbps SAS-3 Waveform Output from "Link Extender Board"

Additional testing with the DS125BR820 using the setup in Figure 10 shows SAS-3 channel extension of approximately 10 dB is possible with good isolation between channels. This diagram shows DS125BR820 placement at both 10 dB and 25 dB away from the SAS-3 ASIC Tx. Further testing verified that all locations between 10 – 25 dB resulted in error free system performance.

**Figure 10. 12 Gbps SAS-3 Testing with System ASIC**

## 5 Passing Out Of Band (OOB) Signals

Out of Band (OOB) Signaling is used in SATA and SAS to enable device-to-device communication and negotiation in a storage environment. This signaling uses a series of Idle and Active periods with specific timing. Any impact to this timing could cause major problems within a storage system. This makes undistorted propagation of the OOB signaling extremely important to a storage system design engineer.

Highlighting some key OOB signaling specifications from SATA3.1 gives some guidelines for the type of OOB and signal noise which could be encountered in a real storage system.

**Table 5. OOB Specifications**

PARAMETER	UNITS	LIMIT	ELECTRICAL SPECIFICATION		
			Gen 1	Gen 2	Gen 3
V <sub>THRESH</sub> : OOB Signal Detection Threshold	mVppd	Min	50	75	75
		Nom	100	125	125
		Max	200	200	200
COMINIT/COMRESET and COMWAKE Transmit Burst Length	ns	Min	103.5		
		Nom	106.7		
		Max	109.9		
COMINIT/COMRESET Transmit Gap Length	ns	Min	310.4		
		Nom	320.0		
		Max	329.6		
COMWAKE Transmit Gap Length	ns	Min	103.5		
		Nom	106.7		
		Max	109.9		

Using the COMWAKE waveform burst timing and a noise level equal to the typical OOB signal detection threshold represents a very difficult problem for most re-driver components. With a fully linear datapath, the DS125BR820 overcomes any distortion issues while propagating this waveform across SAS/SATA links ensuring robust OOB communication.

The visible noise injected in [Figure 11](#) is 100 mVpp in amplitude at a frequency of 200 MHz.

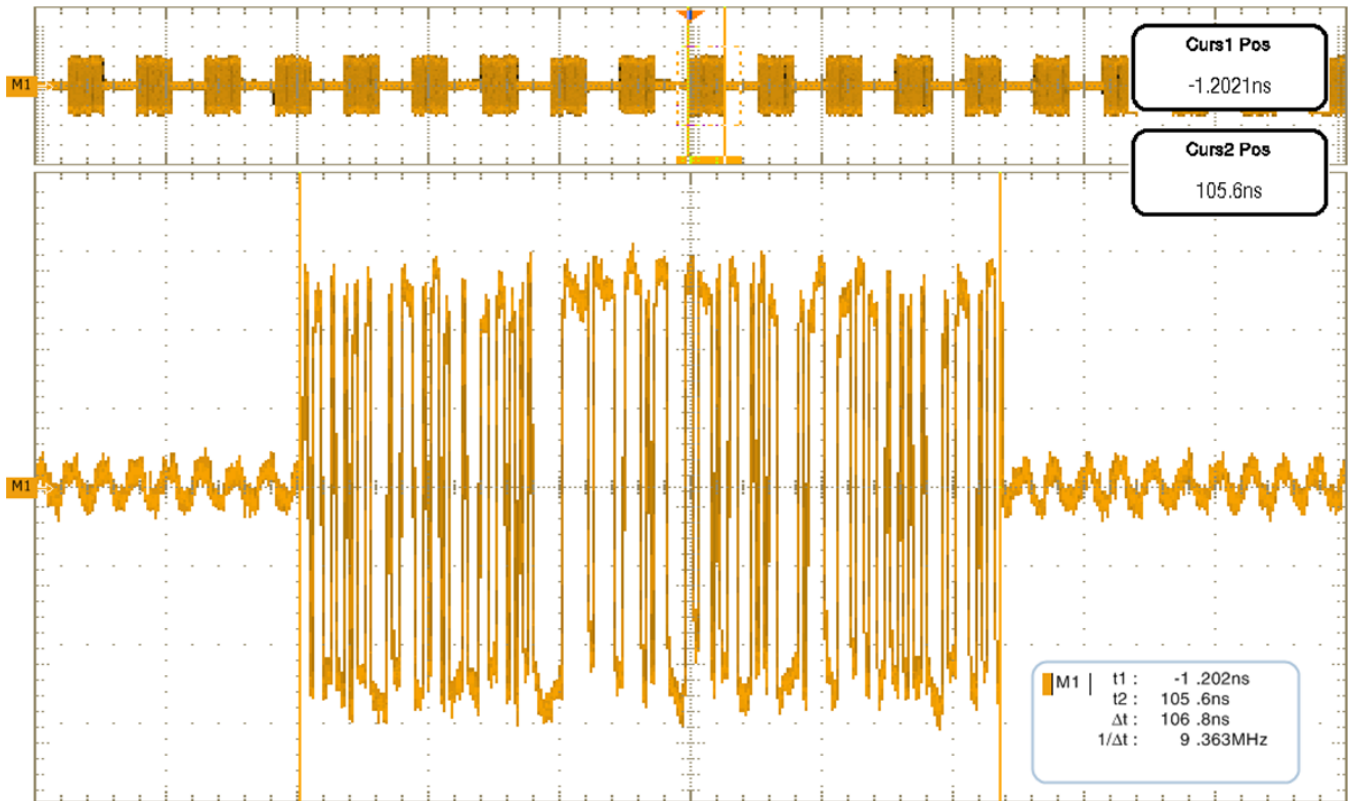

Figure 11. OOB Signaling at DS125BR820 Input

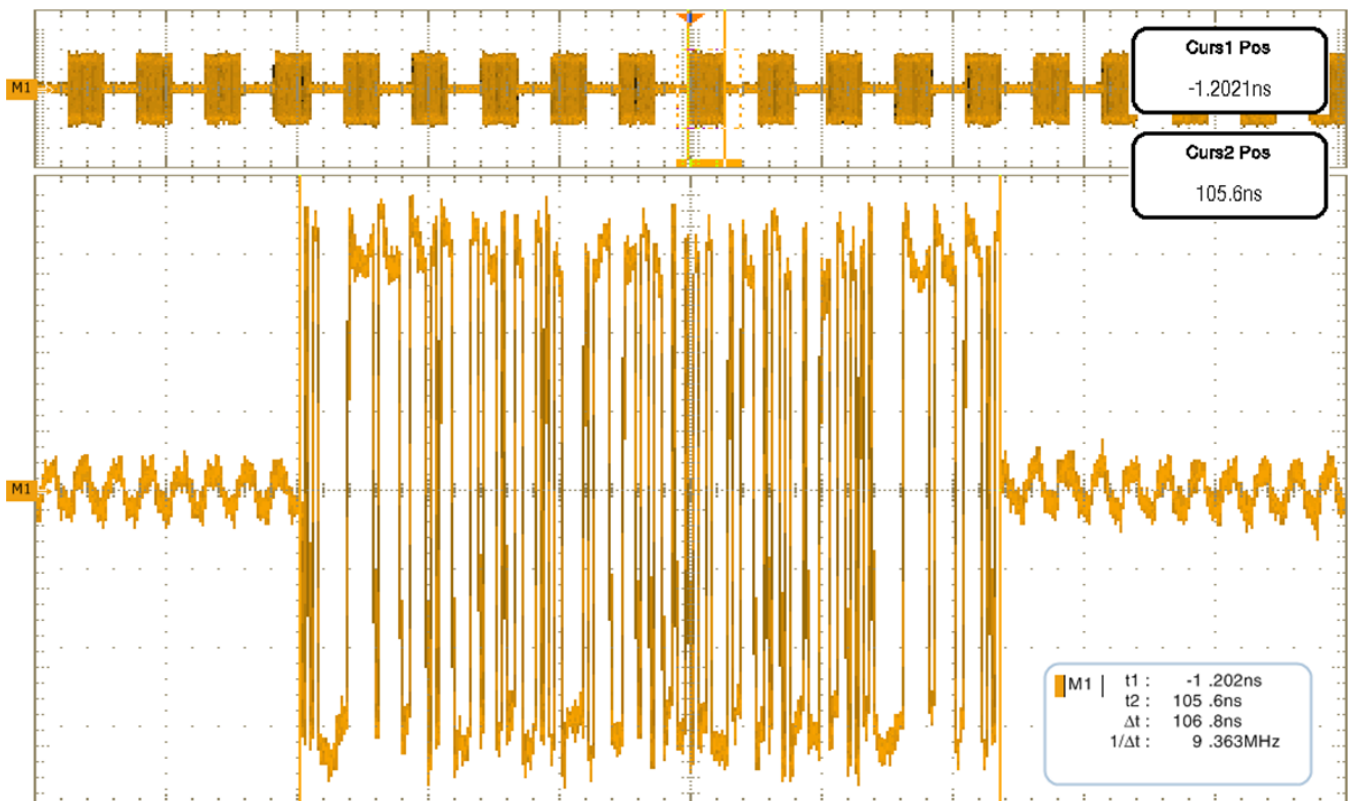

Figure 12. OOB Signaling at DS125BR820 Output

## 6 Conclusions

The DS125BR820 Linear Repeater can enable SAS-3 operation beyond typical system ASIC capability. The CTLE on the DS125BR820 can provide up to 10 dB of high frequency gain helping to compensate for the additional channel losses. Full linear operation allows for consistent link training, helping to establish the best possible eye at the SAS-3 receiver. This channel extension comes without any penalty of OOB signaling amplitude or timing distortion.

## 7 Appendix A: Layout Considerations

Storage applications commonly use miniSAS-HD connectors and cages. The 8-channel DS125BR820 can easily fit adjacent to this style of connector to service all eight channels. Two DS125BR820 repeaters can even be placed on opposing sides of the PCB (top and bottom) if that facilitates board routing. The DS125BR820 does not require a heat sink or airflow, since the power consumption is only 70 mW/channel.

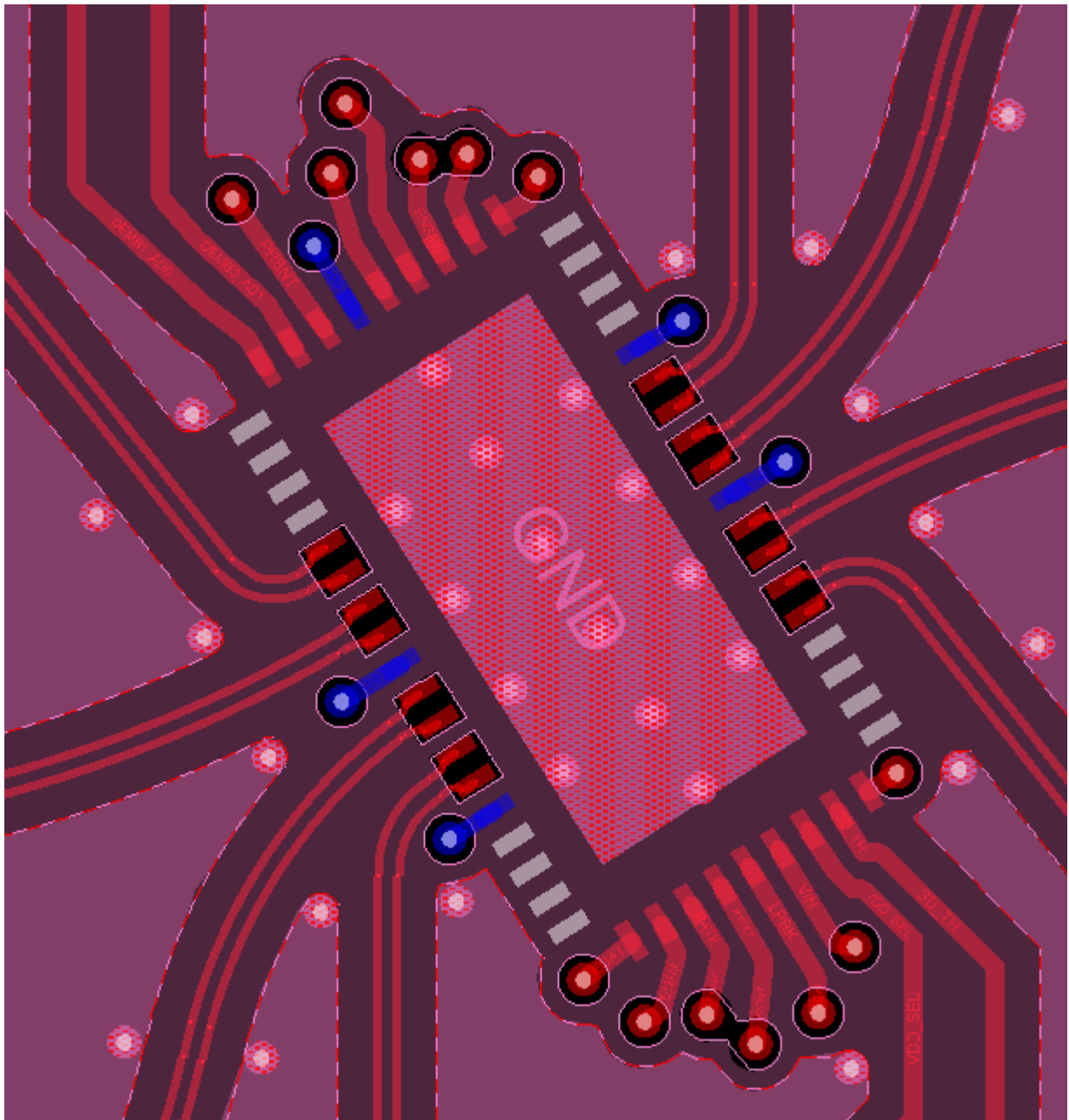

**Figure 13. Evaluation Module Layout Using the DS125BR820**

There are several structures on the evaluation board which aid signal fidelity. In [Figure 13](#) one clear structure is the Reference Plane or GND relief immediately beneath the high speed I/O. By relieving the copper directly under the pads, parasitic capacitance in this area is reduced, helping to bring the local impedance closer to the target value. This is especially true when thin dielectric materials are used to fabricate the outer layers of the PCB.

A similar effect can often be detected at AC coupling capacitors when they are placed close to device transmitter outputs. When the extremely small 0201 size SMT capacitors are used, no relief is required. If 0402 size capacitors are used, a relief cutout like the one in [Figure 14](#) is recommended.

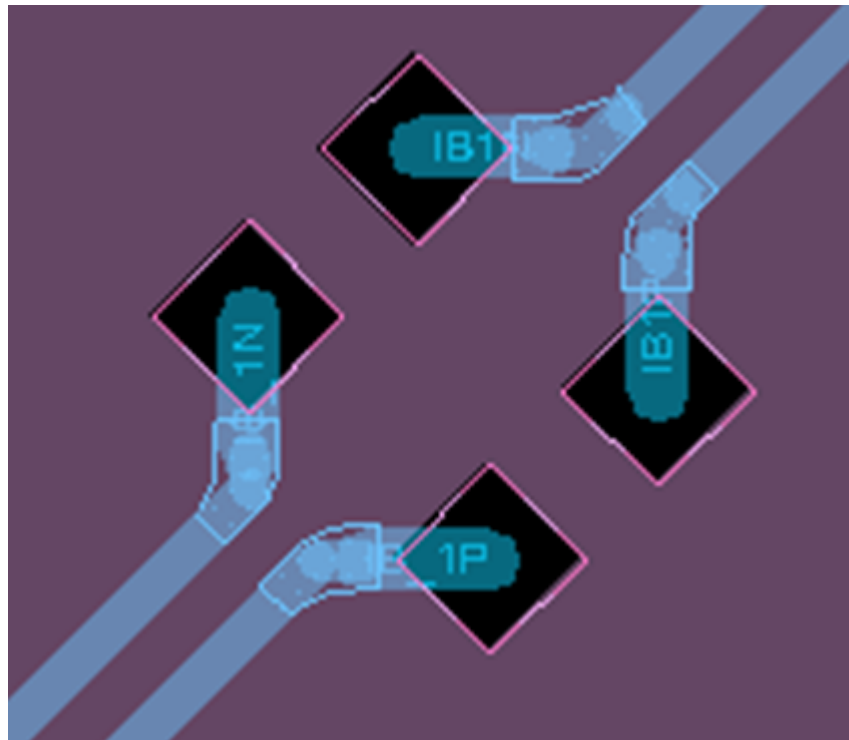

**Figure 14. AC Coupling Capacitor Footprint Relief**

The final “structure” is related to the overall differential pair coupling and pair-to-pair spacing. Signals around this type of component are forced into a relatively small space. Fanning signals out to create additional space between pairs will help to control crosstalk levels. Using a differential microstrip with narrow traces and tight coupling in the breakout area immediately around the repeater will also improve the channel isolation in this densely routed space. The evaluation PCB in [Table 5](#) uses a 5-6-5 (w-s-w) differential pair topology to create a 100  $\Omega$  signaling environment. The minimum channel-to-channel spacing is 24 mils which results in a 4:1 ratio of inter-pair to intra-pair spacing. For high speed and high loss channels, going below this ratio is not recommended.

**Revision History**

<b>DATE</b>	<b>REVISION</b>	<b>NOTES</b>
September 2015	*	Initial release.

## IMPORTANT NOTICE FOR TI DESIGN INFORMATION AND RESOURCES

Texas Instruments Incorporated ("TI") technical, application or other design advice, services or information, including, but not limited to, reference designs and materials relating to evaluation modules, (collectively, "TI Resources") are intended to assist designers who are developing applications that incorporate TI products; by downloading, accessing or using any particular TI Resource in any way, you (individually or, if you are acting on behalf of a company, your company) agree to use it solely for this purpose and subject to the terms of this Notice.

TI's provision of TI Resources does not expand or otherwise alter TI's applicable published warranties or warranty disclaimers for TI products, and no additional obligations or liabilities arise from TI providing such TI Resources. TI reserves the right to make corrections, enhancements, improvements and other changes to its TI Resources.

You understand and agree that you remain responsible for using your independent analysis, evaluation and judgment in designing your applications and that you have full and exclusive responsibility to assure the safety of your applications and compliance of your applications (and of all TI products used in or for your applications) with all applicable regulations, laws and other applicable requirements. You represent that, with respect to your applications, you have all the necessary expertise to create and implement safeguards that (1) anticipate dangerous consequences of failures, (2) monitor failures and their consequences, and (3) lessen the likelihood of failures that might cause harm and take appropriate actions. You agree that prior to using or distributing any applications that include TI products, you will thoroughly test such applications and the functionality of such TI products as used in such applications. TI has not conducted any testing other than that specifically described in the published documentation for a particular TI Resource.

You are authorized to use, copy and modify any individual TI Resource only in connection with the development of applications that include the TI product(s) identified in such TI Resource. NO OTHER LICENSE, EXPRESS OR IMPLIED, BY ESTOPPEL OR OTHERWISE TO ANY OTHER TI INTELLECTUAL PROPERTY RIGHT, AND NO LICENSE TO ANY TECHNOLOGY OR INTELLECTUAL PROPERTY RIGHT OF TI OR ANY THIRD PARTY IS GRANTED HEREIN, including but not limited to any patent right, copyright, mask work right, or other intellectual property right relating to any combination, machine, or process in which TI products or services are used. Information regarding or referencing third-party products or services does not constitute a license to use such products or services, or a warranty or endorsement thereof. Use of TI Resources may require a license from a third party under the patents or other intellectual property of the third party, or a license from TI under the patents or other intellectual property of TI.

TI RESOURCES ARE PROVIDED "AS IS" AND WITH ALL FAULTS. TI DISCLAIMS ALL OTHER WARRANTIES OR REPRESENTATIONS, EXPRESS OR IMPLIED, REGARDING TI RESOURCES OR USE THEREOF, INCLUDING BUT NOT LIMITED TO ACCURACY OR COMPLETENESS, TITLE, ANY EPIDEMIC FAILURE WARRANTY AND ANY IMPLIED WARRANTIES OF MERCHANTABILITY, FITNESS FOR A PARTICULAR PURPOSE, AND NON-INFRINGEMENT OF ANY THIRD PARTY INTELLECTUAL PROPERTY RIGHTS.

TI SHALL NOT BE LIABLE FOR AND SHALL NOT DEFEND OR INDEMNIFY YOU AGAINST ANY CLAIM, INCLUDING BUT NOT LIMITED TO ANY INFRINGEMENT CLAIM THAT RELATES TO OR IS BASED ON ANY COMBINATION OF PRODUCTS EVEN IF DESCRIBED IN TI RESOURCES OR OTHERWISE. IN NO EVENT SHALL TI BE LIABLE FOR ANY ACTUAL, DIRECT, SPECIAL, COLLATERAL, INDIRECT, PUNITIVE, INCIDENTAL, CONSEQUENTIAL OR EXEMPLARY DAMAGES IN CONNECTION WITH OR ARISING OUT OF TI RESOURCES OR USE THEREOF, AND REGARDLESS OF WHETHER TI HAS BEEN ADVISED OF THE POSSIBILITY OF SUCH DAMAGES.

You agree to fully indemnify TI and its representatives against any damages, costs, losses, and/or liabilities arising out of your non-compliance with the terms and provisions of this Notice.

This Notice applies to TI Resources. Additional terms apply to the use and purchase of certain types of materials, TI products and services. These include; without limitation, TI's standard terms for semiconductor products (<http://www.ti.com/sc/docs/stdterms.htm>), [evaluation modules](#), and [samples](http://www.ti.com/sc/docs/sampterm.htm) (<http://www.ti.com/sc/docs/sampterm.htm>).

Mailing Address: Texas Instruments, Post Office Box 655303, Dallas, Texas 75265  
Copyright © 2018, Texas Instruments Incorporated