

Channel Tuning Made Easy Using Linear Redrivers

Guilherme Borba

ABSTRACT

This report demonstrates the benefits of using Texas Instruments Linear Redrivers to simplify the process of channel tuning and improve system margins. Test results of the [DS125BR820](#) linear redriver operating in various pre-channel and post-channel conditions are presented and show improvements in channel conditions in terms of transmitter pre- and post-cursor error-free operating region. This allows link training to more easily find an optimal operating point that is more robust against system variations. These results are applicable to other Linear Redriver devices in TI's signal conditioning portfolio, including [DS125BR111](#), [DS125BR401A](#), and [DS80PCI810](#).

Contents

1	Introduction	3
2	Pre-Channel and Post-Channel Performance Test	3
3	Conclusions.....	8
Appendix A	10.3125 Gbps Error Count Matrices	9
Appendix B	12.5 Gbps Error Count Matrices	12

List of Figures

1	Test Setup with DS125BR820EVM	3
2	Test Setup without Redriver	3
3	DS125BR820EVM Top Side	4
4	40" (-33.9 dB) Channel No-Redriver	5
5	5" (-5.7 dB) Pre- and 35" (-31.9 dB) Post-channel with Redriver	5
6	45" (-38.2 dB) Channel No-Redriver	5
7	5" (-5.7 dB) Pre- and 40" (-35.3 dB) Post-channel with Redriver	5
8	30" (-31.2 dB) Channel No-Redriver	6
9	5" (-6.8 dB) Pre- and 25" (-27 dB) Post-channel with Redriver.....	6
10	35" (-36 dB) Channel No-Redriver	6
11	10" (-11.9 dB) Pre- and 25" (-27 dB) Post-channel with Redriver.....	6
12	35" (-30.5 dB) Channel No-Redriver	7
13	5" (-5.7 dB) Pre- and 40" (-35.3 dB) Post-channel with Redriver	7
14	30" (-31.2 dB) Channel No-Redriver	7
15	10" (-11.9 dB) Pre- and 25" (-27 dB) Post-channel with Redriver.....	7
16	40" (-33.9 dB) Channel No-Redriver	9
17	5" (-5.7 dB) Pre- and 35" (-31.9 dB) Post-channel with Redriver	9
18	40" (-33.9 dB) Channel No-Redriver	9
19	15" (-14.5 dB) Pre- and 25" (-22.9 dB) Post-channel with Redriver	9
20	40" (-33.9 dB) Channel No-Redriver	9
21	25" (-22.9 dB) Pre- and 15" (-14.5 dB) Post-channel with Redriver	9
22	40" (-33.9 dB) Channel No-Redriver.....	10
23	35" (-31.9 dB) Pre- and 5" (-5.7 dB) Post-channel with Redriver	10

All trademarks are the property of their respective owners.

24	45" (-38.2 dB) Channel No-Redriver	10
25	5" (-5.7 dB) Pre- and 40" (-35.3 dB) Post-channel with Redriver	10
26	45" (-38.2 dB) Channel No-Redriver	10
27	15" (-14.5 dB) Pre- and 30" (-27.9 dB) Post-channel with Redriver	10
28	45" (-38.2 dB) Channel No-Redriver	11
29	30" (-27.9 dB) Pre- and 15" (-14.5 dB) Post-channel with Redriver	11
30	45" (-38.2 dB) Channel No-Redriver	11
31	40" (-35.3 dB) Pre- and 5" (-5.7 dB) Post-channel with Redriver	11
32	30" (-31.2 dB) Channel No-Redriver	12
33	5" (-6.8 dB) Pre- and 25" (-27 dB) Post-channel with Redriver	12
34	30" (-31.2 dB) Channel No-Redriver	12
35	10" (-11.9 dB) Pre- and 20" (-22.1 dB) Post-channel with Redriver	12
36	30" (-31.2 dB) Channel No-Redriver	12
37	20" (-22.1 dB) Pre- and 10" (-11.9 dB) Post-channel with Redriver	12
38	30" (-31.2 dB) Channel No-Redriver	13
39	25" (-27 dB) Pre- and 5" (-6.8 dB) Post-channel with Redriver	13
40	35" (-36 dB) Channel No-Redriver	13
41	5" (-6.8 dB) Pre- and 30" (-32.9 dB) Post-channel with Redriver	13
42	35" (-36 dB) Channel No-Redriver	13
43	10" (-11.9 dB) Pre- and 25" (-27 dB) Post-channel with Redriver	13
44	35" (-36 dB) Channel No-Redriver	14
45	25" (-27 dB) Pre- and 10" (-11.9 dB) Post-channel with Redriver	14
46	35" (-36 dB) Channel No-Redriver	14
47	30" (-32.9 dB) Pre- and 5" (-6.8 dB) Post-channel with Redriver	14

List of Tables

1	DS125BR820 Settings Used for Testing	5
---	--	---

1 Introduction

The testing carried out in this report involves the [DS125BR820](#) Low-Power 12.5 Gbps 8-Channel Linear Redriver, which is designed to support 40GbE (40G-CR4/KR4/SR4/LR4), 10GbE (10G-KR, SFF-8431), 12G SAS-3, PCIe Gen 3.0, and other applications up to 12.5Gbps. The linear nature of the [DS125BR820](#)'s equalization allows the [DS125BR820](#) to preserve the transmit signal characteristics of the host ASIC, thereby allowing the host and the link partner ASIC to negotiate transmit equalizer coefficients during Link Training. These results are applicable to other Linear Redriver devices in TI's signal conditioning portfolio, including [DS125BR111](#), [DS125BR401A](#), and [DS80PCI810](#).

2 Pre-Channel and Post-Channel Performance Test

This test was conducted by varying the length of channel segments at the input and output of the [DS125BR820](#), known as pre-channel and post-channel respectively. For each pre- and post-channel configuration, the transmitter pre- and post-cursor settings were swept, and the number of bit errors was recorded for 97 seconds (> 1E12 bits). In addition, baseline tests were conducted without the [DS125BR820](#) Linear Redriver for different lengths of channel. The goal of this test was to compare the system's region of error-free operation for a given total channel length with and without the [DS125BR820](#).

2.1 Test Setup – Hardware

The ASIC transmitter output is connected to a trace board (pre-channel) and then to the input of the [DS125BR820EVM](#). The output of the [DS125BR820EVM](#) is connected to another trace board (post-channel) followed by the ASIC receiver. In the no-redriver test case, the [DS125BR820EVM](#) is removed and replaced with two female-to-female SMA connectors, leaving only PCB trace between the transmitter and receiver. A diagram of the test setup with the redriver is shown in [Figure 1](#). A diagram of the equivalent no-redriver test case is shown in [Figure 2](#).

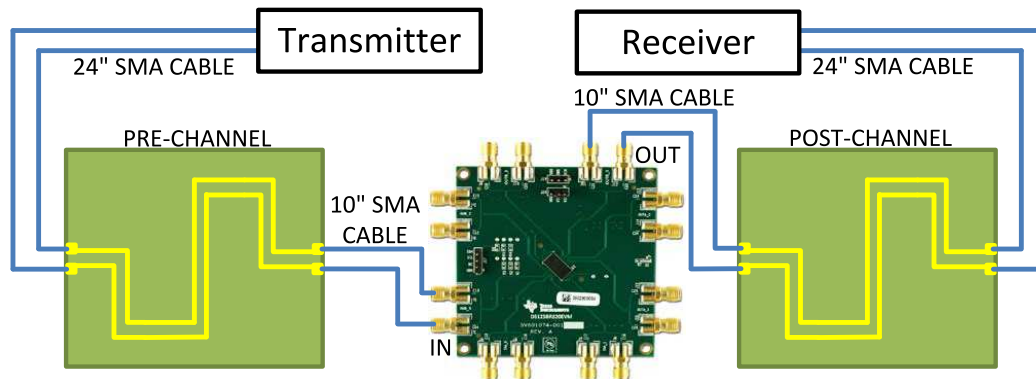

Figure 1. Test Setup with DS125BR820EVM

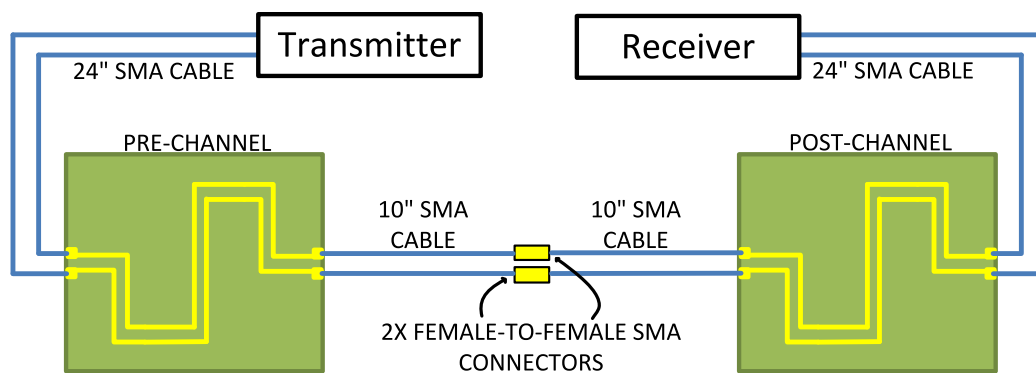

Figure 2. Test Setup without Redriver

2.1.1 DS125BR820EVM

The [DS125BR820EVM](#) SMA evaluation kit provides a complete platform to evaluate the signal conditioning features of the Texas Instruments [DS125BR820](#) redriver. The [DS125BR820EVM](#) can be used for standards compliance testing, performance evaluation, and system prototyping. The equalization settings (EQ) and output differential amplitude (VOD) can be adjusted by strapping control pins to the proper logic levels, or register programming through SMBus serial interface.

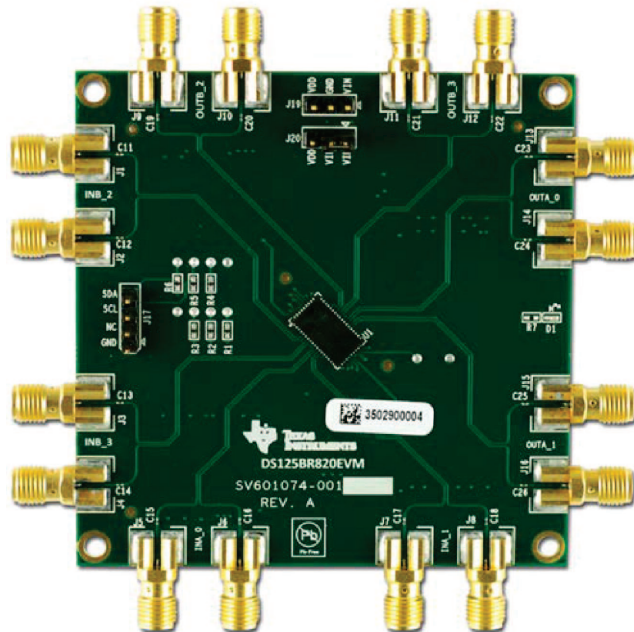

Figure 3. DS125BR820EVM Top Side

2.1.2 ASIC Transmitter

A generic, commercially-available transmitter was used as the source of the 10.3125 Gbps and 12.5 Gbps PRBS31 data in this test. The differential output amplitude was configured to be 780 mV peak-to-peak. A frequency offset of ~210 ppm was introduced between the transmitter and receiver. The transmitter sweeps pre-cursor values from -3.1 dB to 0 dB (-15% to 0%) and post-cursor from -10.5 dB to 0 dB (-35% to 0%).

2.1.3 ASIC Receiver

A generic, commercially-available receiver was used to check the PRBS31 data for bit errors. This receiver has a continuous-time linear equalizer (CTLE) with up to 14 dB of equalization capability as well as a five-tap decision feedback equalizer (DFE). Both the CTLE and DFE are automatically adapted in real time to optimize the post-equalized eye height.

2.1.4 FR4 Microstrip Trace Boards

Various FR4 differential microstrip trace boards are used to mimic pre- and post-channel conditions of a real system. These boards vary in length from 5 to 40 inches (4 mil trace width) in steps of 5 inches.

2.2 Test Setup – Device Configuration

The settings used for the [DS125BR820](#) Redriver in these tests are listed in Table 1. Lower EQ settings may be more suitable for shorter channel lengths.

Table 1. DS125BR820 Settings Used for Testing

EQ SETTING			VOD SETTING		
Value	Pin Strap	Equivalent Register Setting ⁽¹⁾	Value	Pin Strap	Equivalent Register Setting ⁽²⁾
Level 3	1 (1 kΩ to VIH ⁽³⁾)	Reg_0xF = 0x03	Level 6	VODA1 = VODB1 = 1 (1 kΩ to VIH ⁽³⁾) VODA1 = VODB1 = 0 (1 kΩ to GND)	Reg_0x10 = 0xAE

⁽¹⁾ Each channel has its own EQ control register. Reg_0x0F controls channel 0. Reg_0x16 controls channel 1, and so on.

⁽²⁾ Each channel has its own VOD control register. Reg_0x10 controls channel 0. Reg_0x17 controls channel 1, and so on.

⁽³⁾ VIH is nominally 2.5 V when the device is in 2.5-V Mode, or 3.3 V when the device is in 3.3-V Mode. For more details, see the electrical characteristics table of the device datasheet.

2.3 Results

The measurements are plotted in a matrix where the x-axis is the post-cursor value in decibels and the y-axis is the pre-cursor value in decibels applied by the ASIC TX. The total error count during the 97 second test is shown in each point and is color coded to represent the total error range. Green means there were zero errors, and red represents the maximum number of the error counter, 4,095. Some examples can be seen in [Figure 6](#) through [Figure 11](#). For all of the data with various channel configurations, see [Appendix A](#) and [Appendix B](#).

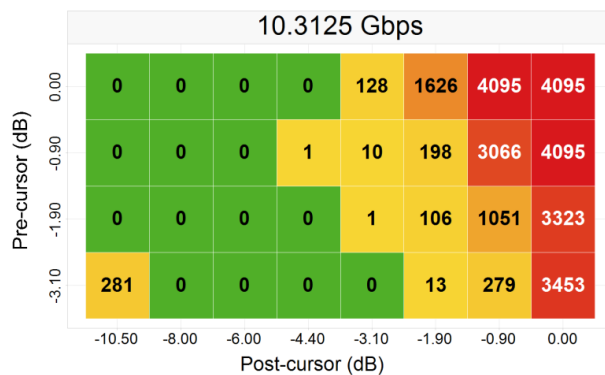

Figure 4. 40" (-33.9 dB) Channel No-Redriver

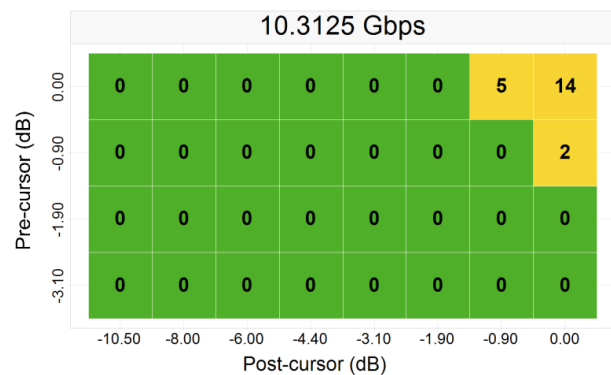

Figure 5. 5" (-5.7 dB) Pre- and 35" (-31.9 dB) Post-channel with Redriver

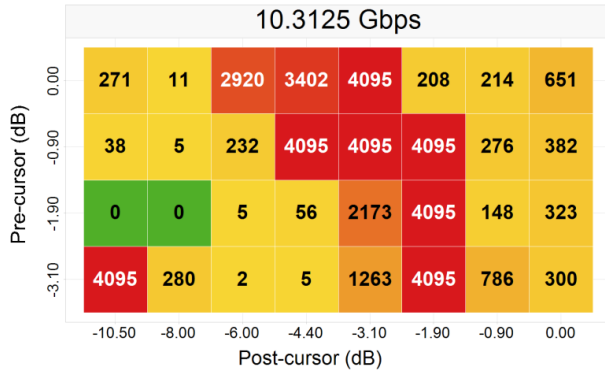

Figure 6. 45" (-38.2 dB) Channel No-Redriver

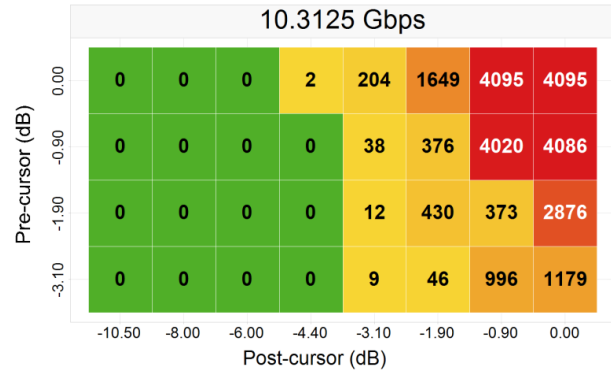

Figure 7. 5" (-5.7 dB) Pre- and 40" (-35.3 dB) Post-channel with Redriver

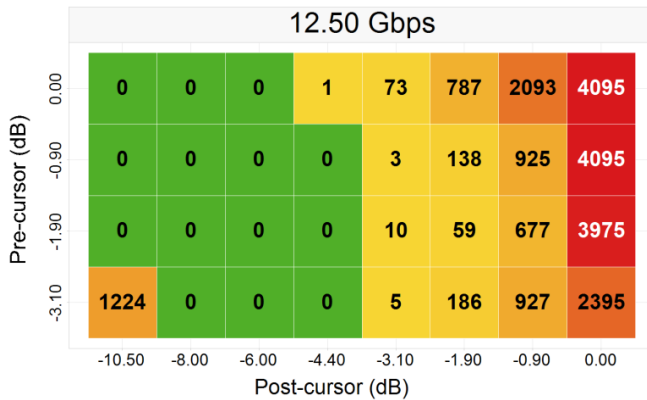

Figure 8. 30" (-31.2 dB) Channel No-Redriver

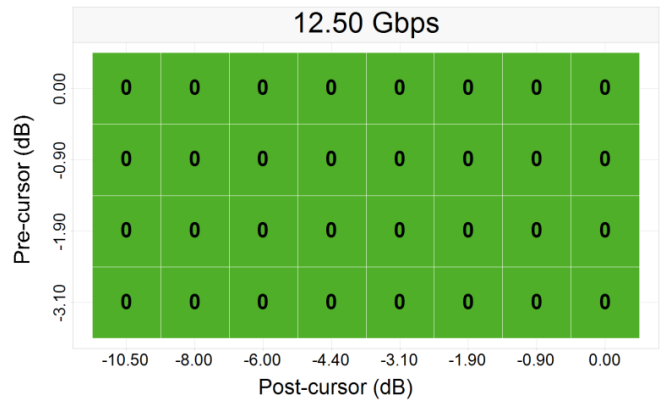

Figure 9. 5" (-6.8 dB) Pre- and 25" (-27 dB) Post-channel with Redriver

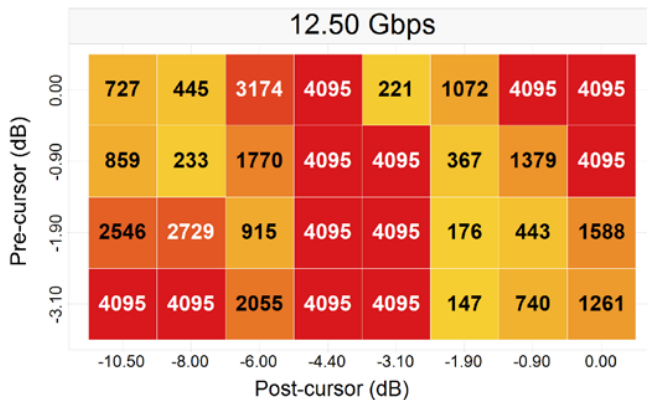

Figure 10. 35" (-36 dB) Channel No-Redriver

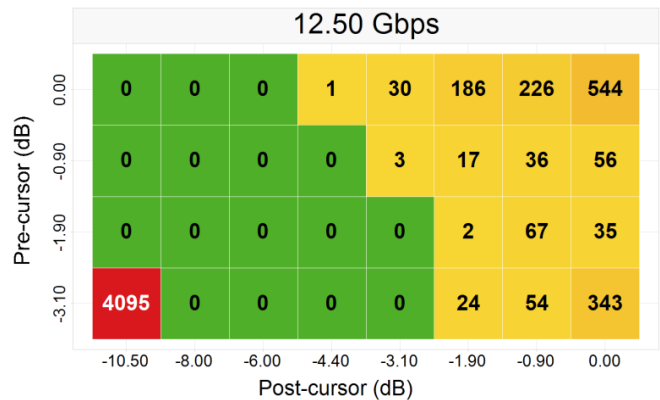

Figure 11. 10" (-11.9 dB) Pre- and 25" (-27 dB) Post-channel with Redriver

NOTE: In addition to comparing the performance of with-redriver and no-redriver cases for similar total channel lengths, no-redriver tests with a given channel length were compared to with-redriver tests with a longer channel length for the purposes of demonstrating channel reach extension. This is shown in [Figure 12](#) and [Figure 13](#) (35" against 45" at 10.3125 Gbps), and [Figure 14](#) and [Figure 15](#) (30" against 35" at 12.5 Gbps).

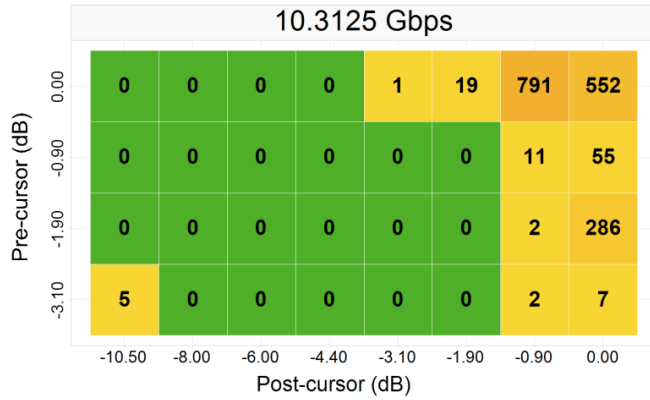

Figure 12. 35" (-30.5 dB) Channel No-Redriver

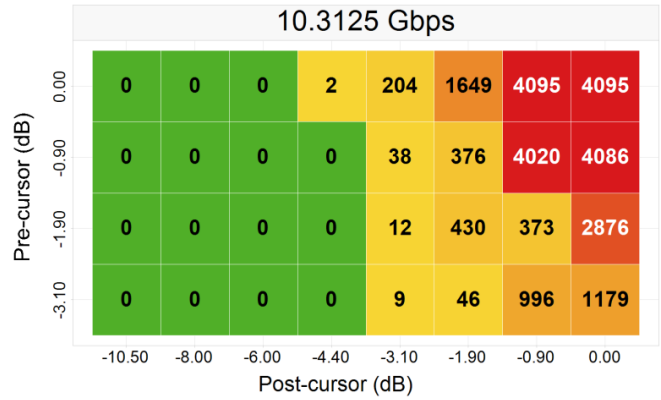

Figure 13. 5" (-5.7 dB) Pre- and 40" (-35.3 dB) Post-channel with Redriver

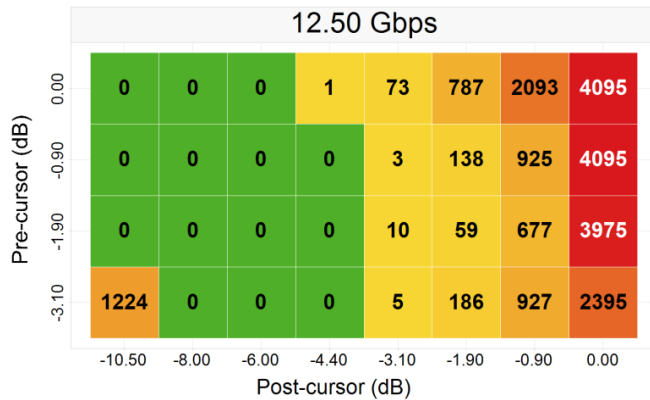

Figure 14. 30" (-31.2 dB) Channel No-Redriver

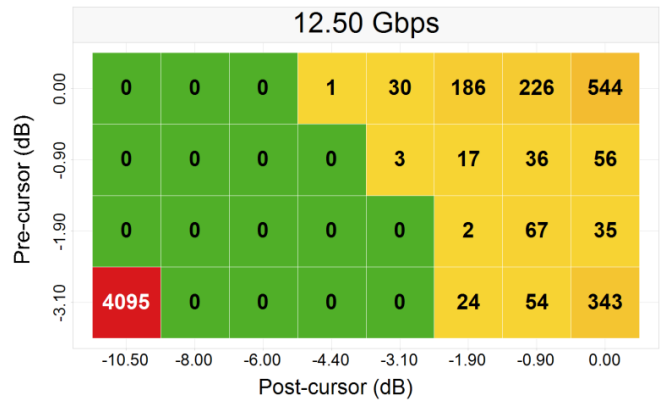

Figure 15. 10" (-11.9 dB) Pre- and 25" (-27 dB) Post-channel with Redriver

3 Conclusions

The [DS125BR820](#) Linear Redriver shows a clear improvement in the size of the error-free region for a given channel length, as shown in [Figure 4](#) through [Figure 11](#). This increase in system margin is a great advantage because link training happens very quickly and the resulting operating point may not be optimal due to normal run-to-run variations. Having a larger error-free operating region is helpful to ensure best chances of link training finding an error-free operating point. Having a larger error-free region is also beneficial because the system characteristics may change over time due to ambient temperature changes or voltage supply fluctuations.

Furthermore, [Figure 12](#) through [Figure 15](#) shows it is possible to extend the overall channel reach of the system by utilizing TI's linear redrivers. At both 10.3125 Gbps and 12.5 Gbps, similar system margins were obtained with up to 10 dB additional insertion loss as a result of using the [DS125BR820](#) Linear Redriver.

TI's Linear Redrivers add system flexibility thereby relaxing the requirements for the ASIC and simplifying the process of channel tuning. This can provide advantages in overall system cost, power consumption, and time to market.

10.3125 Gbps Error Count Matrices

The following figures show a comparison between the error count matrices for the with and without redriver cases for 10.3125 Gbps. Note that 4,095 is the maximum number of errors and the loss in decibels includes the trace losses of the EVM and all other parts of the test fixture.

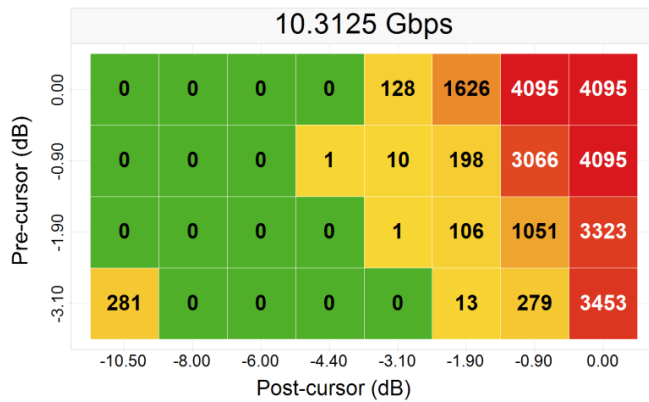

Figure 16. 40" (-33.9 dB) Channel No-Redriver

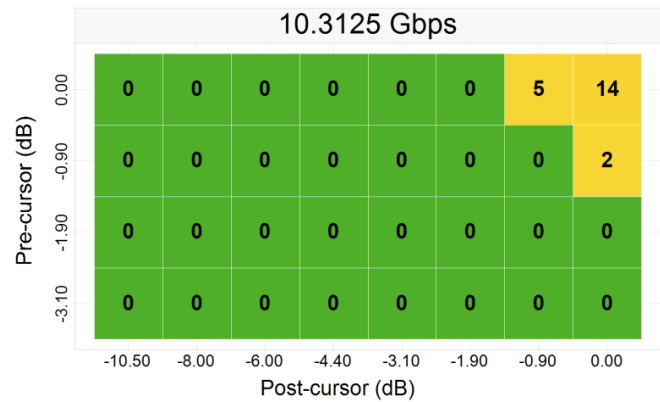

Figure 17. 5" (-5.7 dB) Pre- and 35" (-31.9 dB) Post-channel with Redriver

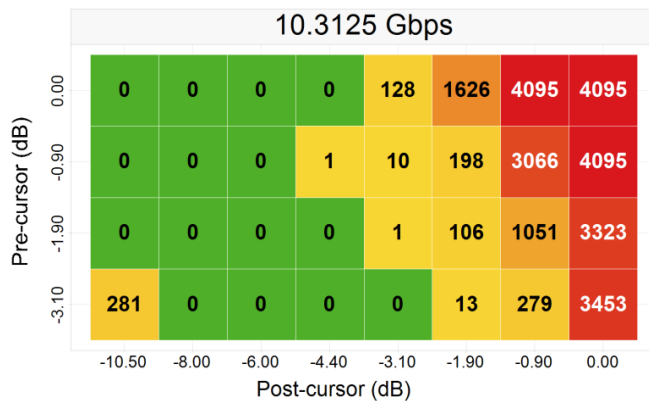

Figure 18. 40" (-33.9 dB) Channel No-Redriver

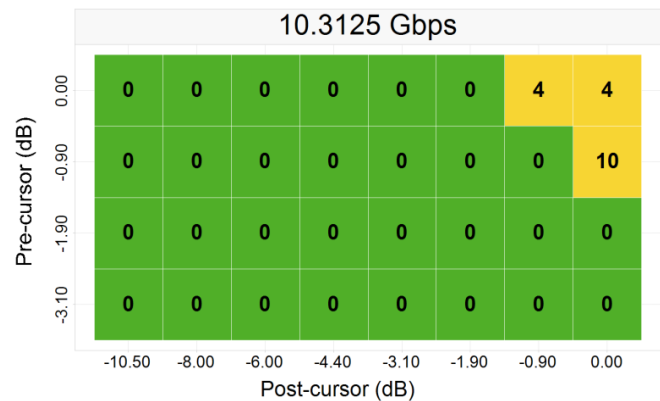

Figure 19. 15" (-14.5 dB) Pre- and 25" (-22.9 dB) Post-channel with Redriver

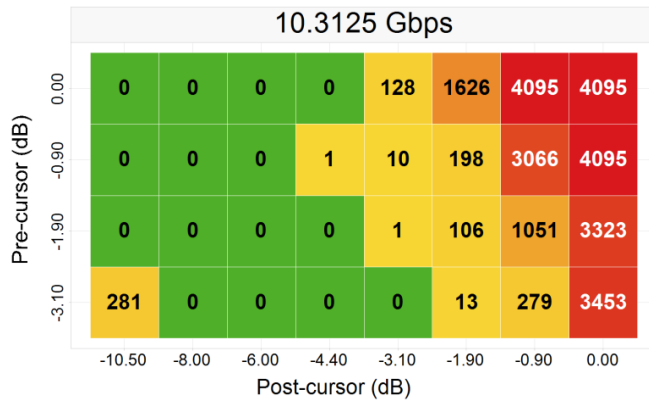

Figure 20. 40" (-33.9 dB) Channel No-Redriver

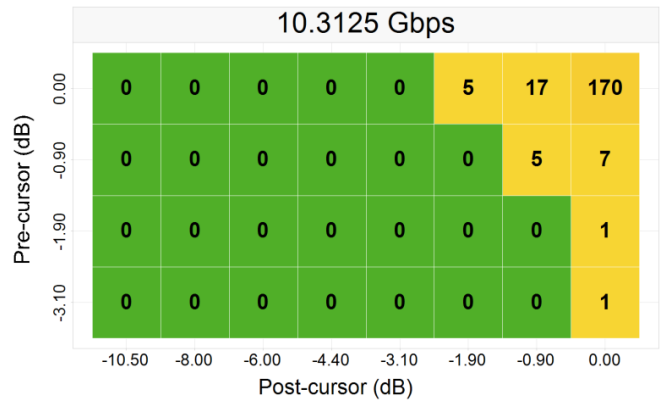

Figure 21. 25" (-22.9 dB) Pre- and 15" (-14.5 dB) Post-channel with Redriver

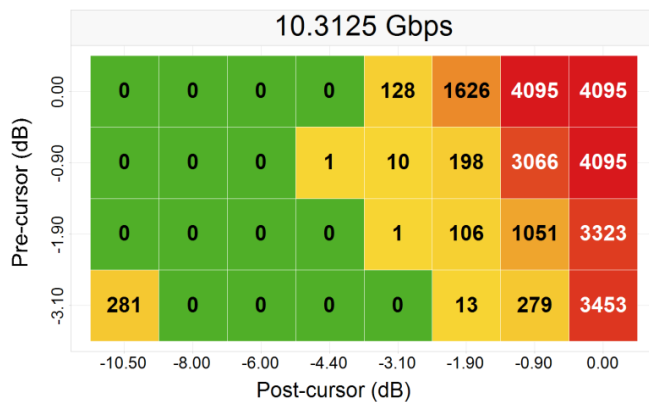

Figure 22. 40" (-33.9 dB) Channel No-Redriver

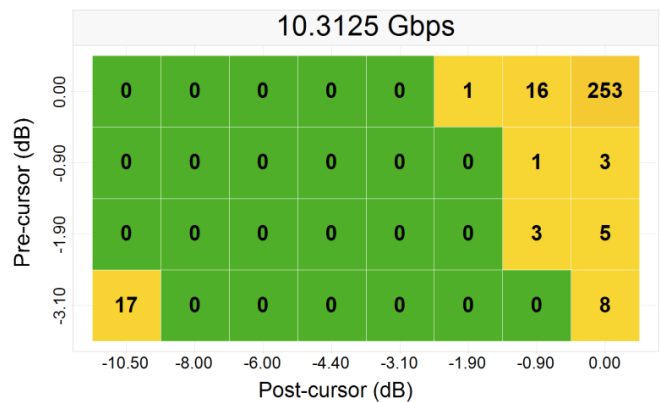

Figure 23. 35" (-31.9 dB) Pre- and 5" (-5.7 dB) Post-channel with Redriver

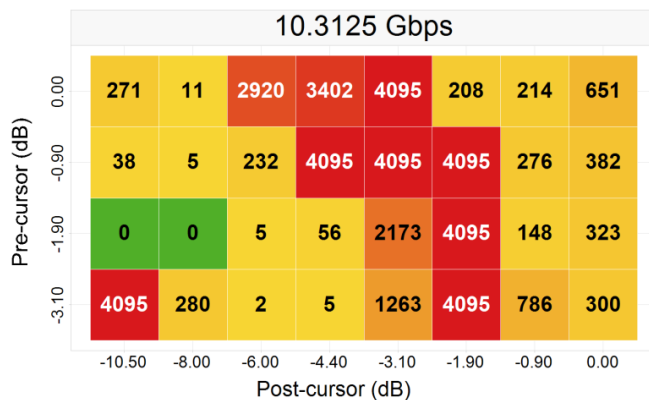

Figure 24. 45" (-38.2 dB) Channel No-Redriver

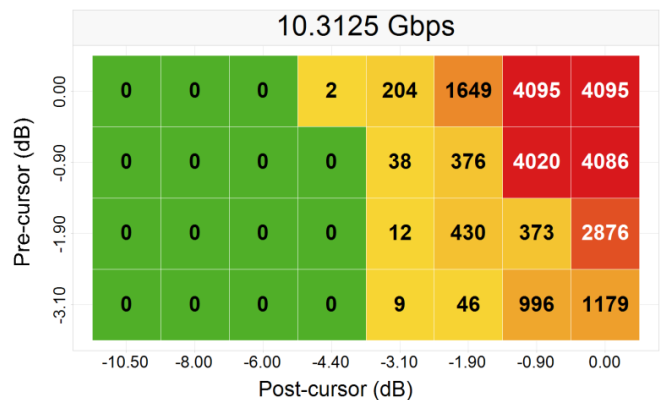

Figure 25. 5" (-5.7 dB) Pre- and 40" (-35.3 dB) Post-channel with Redriver

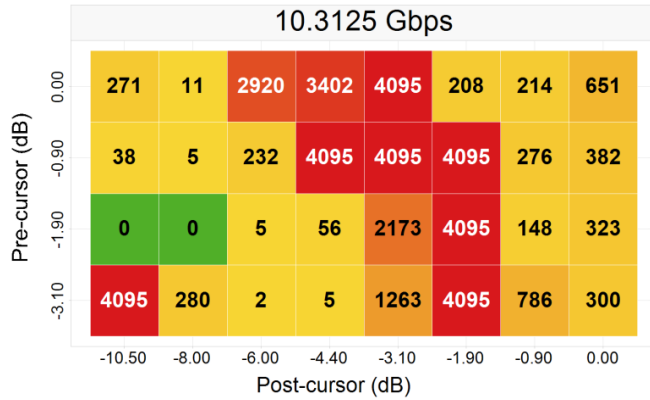

Figure 26. 45" (-38.2 dB) Channel No-Redriver

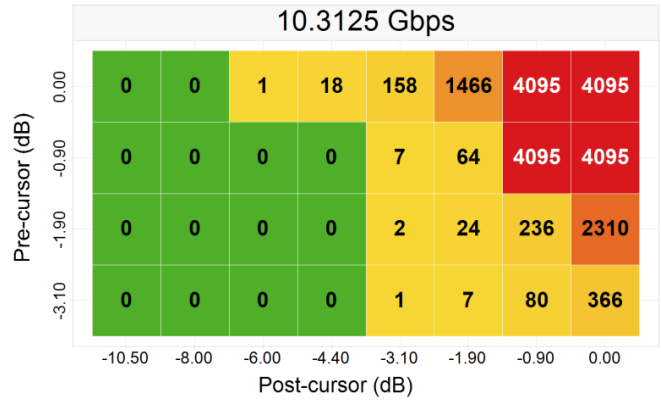

Figure 27. 15" (-14.5 dB) Pre- and 30" (-27.9 dB) Post-channel with Redriver

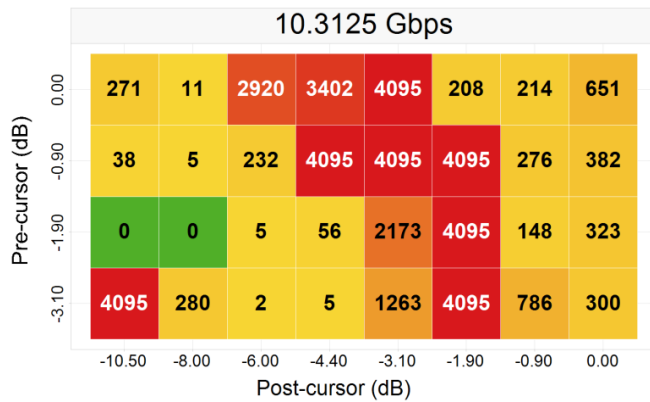

Figure 28. 45" (-38.2 dB) Channel No-Redriver

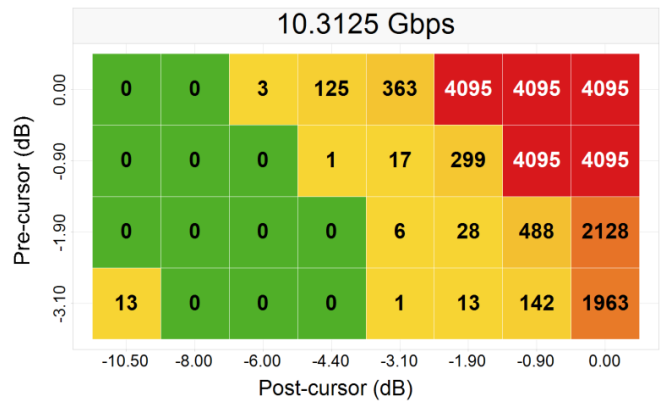

Figure 29. 30" (-27.9 dB) Pre- and 15" (-14.5 dB) Post-channel with Redriver

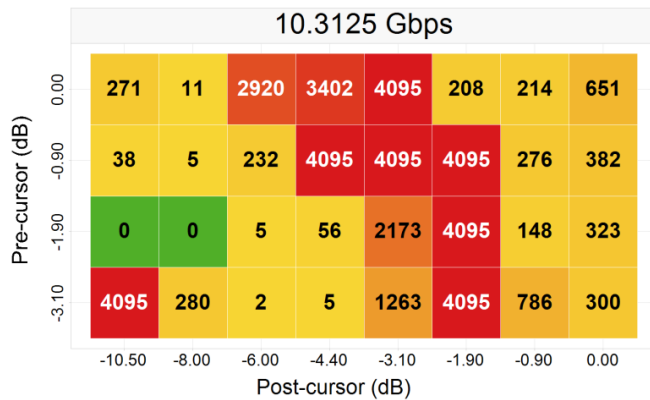

Figure 30. 45" (-38.2 dB) Channel No-Redriver

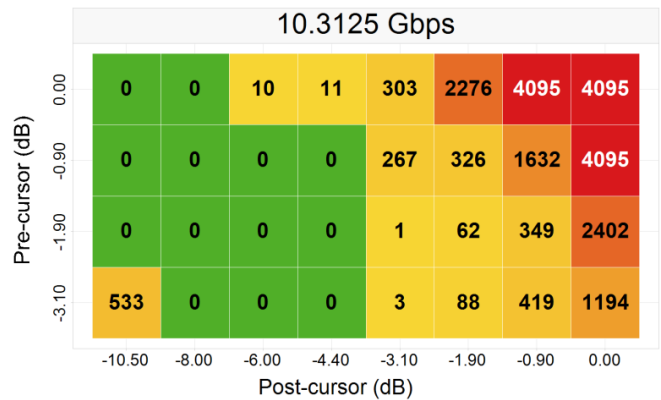

Figure 31. 40" (-35.3 dB) Pre- and 5" (-5.7 dB) Post-channel with Redriver

12.5 Gbps Error Count Matrices

The following figures show a comparison between the error count matrices for the with and without redriver cases for 12.5 Gbps. Note that 4,095 is the maximum number of errors and the loss in decibels includes the trace losses of the EVM and all other parts of the test fixture.

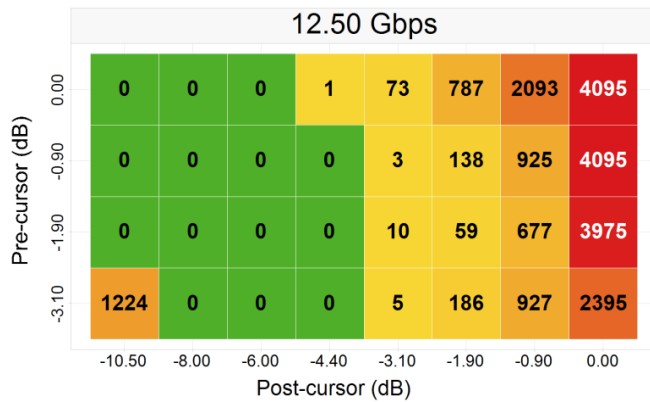

Figure 32. 30" (-31.2 dB) Channel No-Redriver

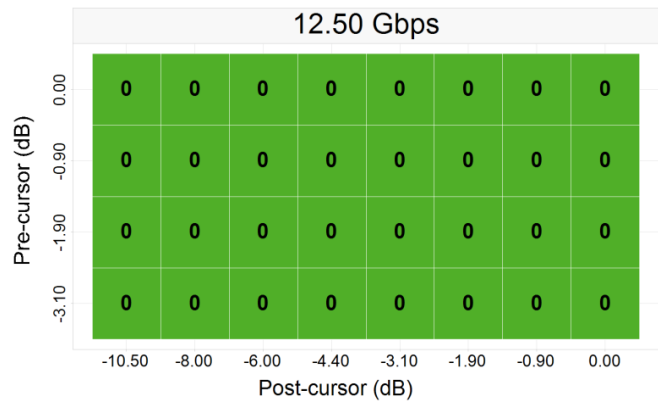

Figure 33. 5" (-6.8 dB) Pre- and 25" (-27 dB) Post-channel with Redriver

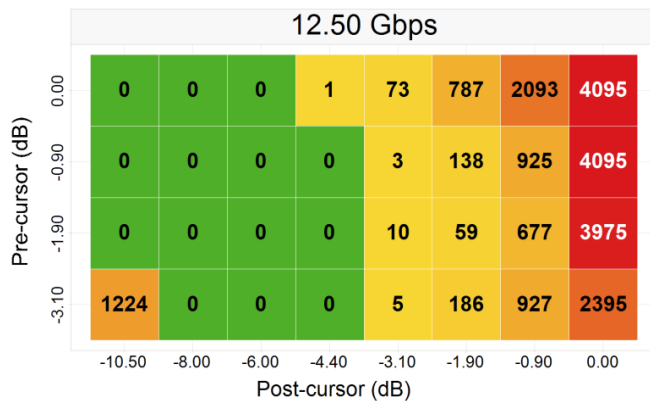

Figure 34. 30" (-31.2 dB) Channel No-Redriver

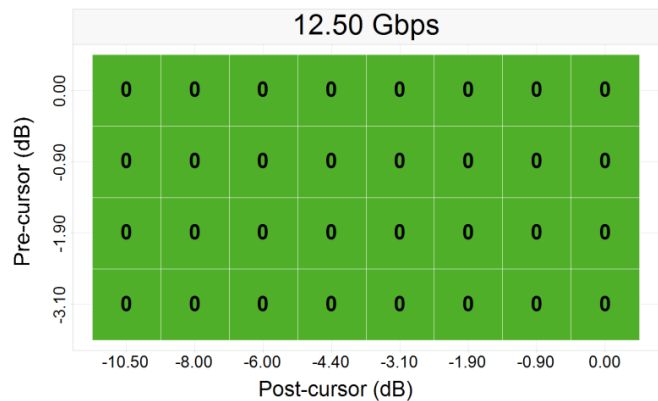

Figure 35. 10" (-11.9 dB) Pre- and 20" (-22.1 dB) Post-channel with Redriver

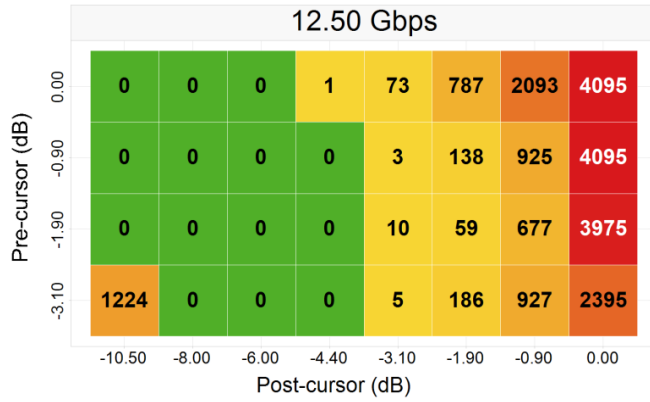

Figure 36. 30" (-31.2 dB) Channel No-Redriver

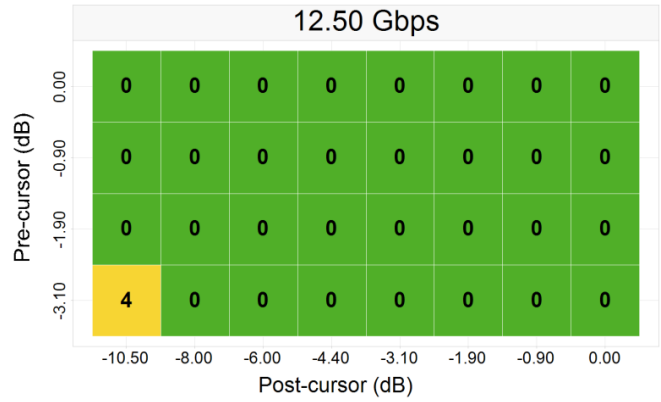

Figure 37. 20" (-22.1 dB) Pre- and 10" (-11.9 dB) Post-channel with Redriver

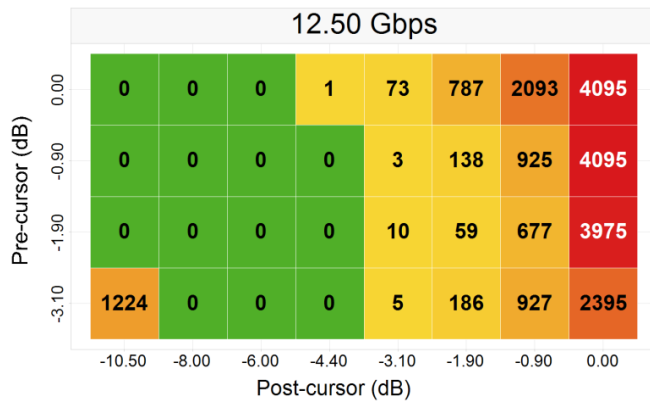

Figure 38. 30" (-31.2 dB) Channel No-Redriver

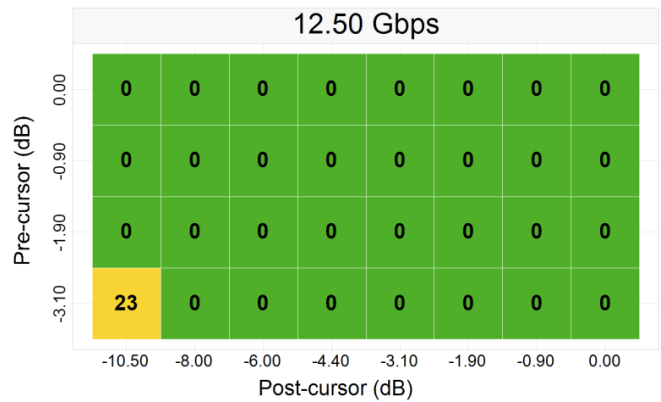

Figure 39. 25" (-27 dB) Pre- and 5" (-6.8 dB) Post-channel with Redriver

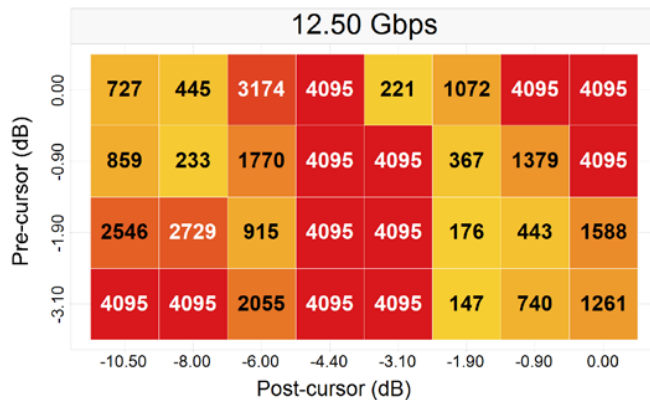

Figure 40. 35" (-36 dB) Channel No-Redriver

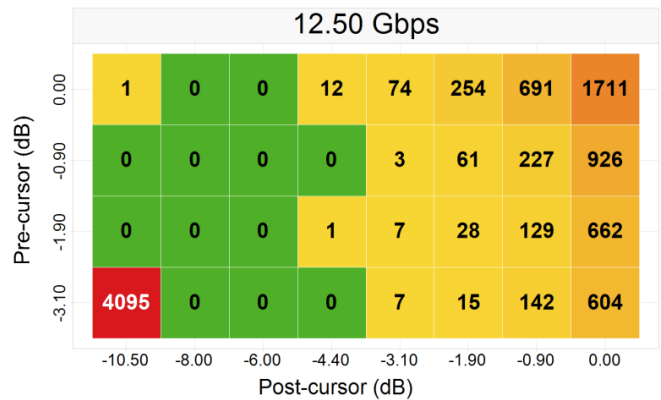

Figure 41. 5" (-6.8 dB) Pre- and 30" (-32.9 dB) Post-channel with Redriver

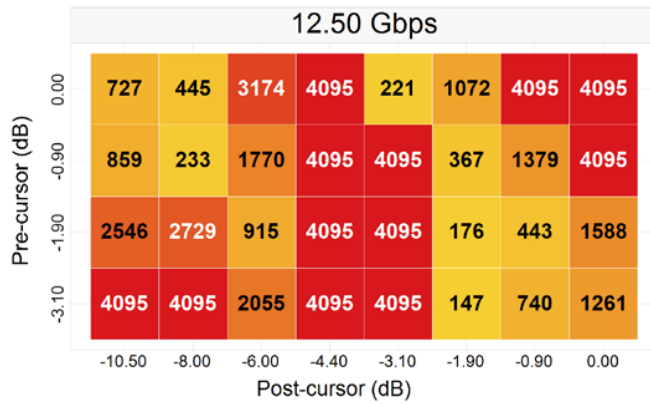

Figure 42. 35" (-36 dB) Channel No-Redriver

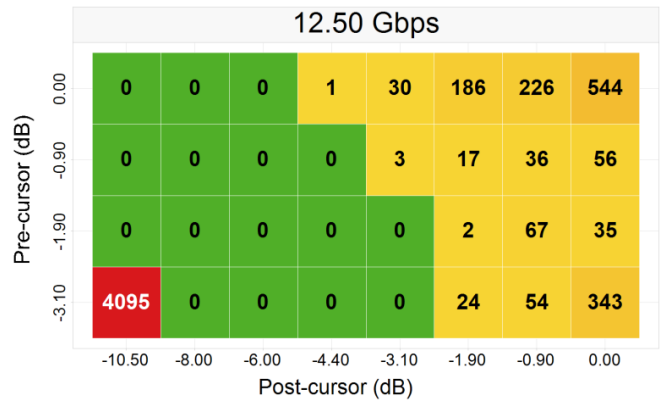

Figure 43. 10" (-11.9 dB) Pre- and 25" (-27 dB) Post-channel with Redriver

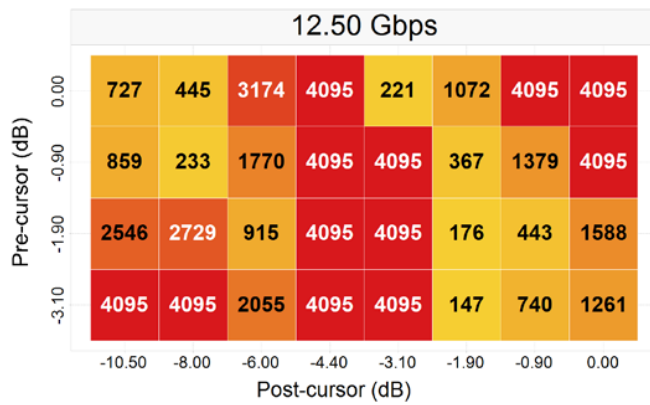

Figure 44. 35" (-36 dB) Channel No-Redriver

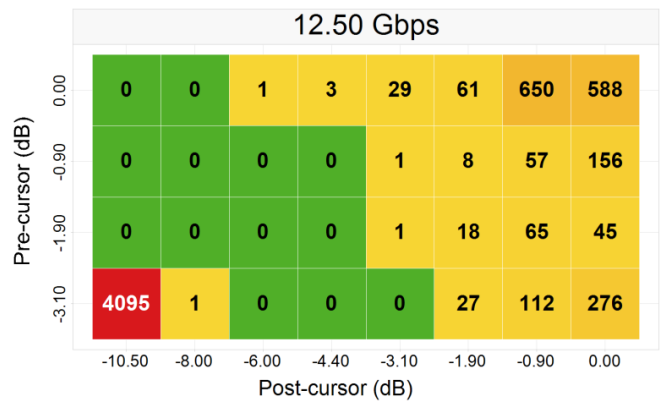

Figure 45. 25" (-27 dB) Pre- and 10" (-11.9 dB) Post-channel with Redriver

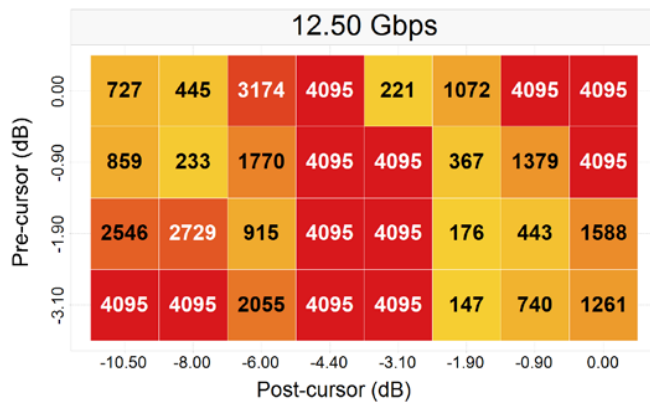

Figure 46. 35" (-36 dB) Channel No-Redriver

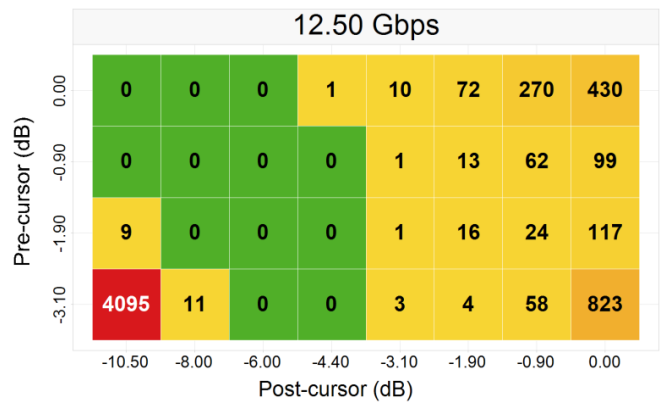

Figure 47. 30" (-32.9 dB) Pre- and 5" (-6.8 dB) Post-channel with Redriver

STANDARD TERMS AND CONDITIONS FOR EVALUATION MODULES

1. *Delivery:* TI delivers TI evaluation boards, kits, or modules, including any accompanying demonstration software, components, or documentation (collectively, an "EVM" or "EVMs") to the User ("User") in accordance with the terms and conditions set forth herein. Acceptance of the EVM is expressly subject to the following terms and conditions.
 - 1.1 EVMs are intended solely for product or software developers for use in a research and development setting to facilitate feasibility evaluation, experimentation, or scientific analysis of TI semiconductors products. EVMs have no direct function and are not finished products. EVMs shall not be directly or indirectly assembled as a part or subassembly in any finished product. For clarification, any software or software tools provided with the EVM ("Software") shall not be subject to the terms and conditions set forth herein but rather shall be subject to the applicable terms and conditions that accompany such Software
 - 1.2 EVMs are not intended for consumer or household use. EVMs may not be sold, sublicensed, leased, rented, loaned, assigned, or otherwise distributed for commercial purposes by Users, in whole or in part, or used in any finished product or production system.
2. *Limited Warranty and Related Remedies/Disclaimers:*
 - 2.1 These terms and conditions do not apply to Software. The warranty, if any, for Software is covered in the applicable Software License Agreement.
 - 2.2 TI warrants that the TI EVM will conform to TI's published specifications for ninety (90) days after the date TI delivers such EVM to User. Notwithstanding the foregoing, TI shall not be liable for any defects that are caused by neglect, misuse or mistreatment by an entity other than TI, including improper installation or testing, or for any EVMs that have been altered or modified in any way by an entity other than TI. Moreover, TI shall not be liable for any defects that result from User's design, specifications or instructions for such EVMs. Testing and other quality control techniques are used to the extent TI deems necessary or as mandated by government requirements. TI does not test all parameters of each EVM.
 - 2.3 If any EVM fails to conform to the warranty set forth above, TI's sole liability shall be at its option to repair or replace such EVM, or credit User's account for such EVM. TI's liability under this warranty shall be limited to EVMs that are returned during the warranty period to the address designated by TI and that are determined by TI not to conform to such warranty. If TI elects to repair or replace such EVM, TI shall have a reasonable time to repair such EVM or provide replacements. Repaired EVMs shall be warranted for the remainder of the original warranty period. Replaced EVMs shall be warranted for a new full ninety (90) day warranty period.
3. *Regulatory Notices:*
 - 3.1 *United States*
 - 3.1.1 *Notice applicable to EVMs not FCC-Approved:*

This kit is designed to allow product developers to evaluate electronic components, circuitry, or software associated with the kit to determine whether to incorporate such items in a finished product and software developers to write software applications for use with the end product. This kit is not a finished product and when assembled may not be resold or otherwise marketed unless all required FCC equipment authorizations are first obtained. Operation is subject to the condition that this product not cause harmful interference to licensed radio stations and that this product accept harmful interference. Unless the assembled kit is designed to operate under part 15, part 18 or part 95 of this chapter, the operator of the kit must operate under the authority of an FCC license holder or must secure an experimental authorization under part 5 of this chapter.
 - 3.1.2 *For EVMs annotated as FCC – FEDERAL COMMUNICATIONS COMMISSION Part 15 Compliant:*

CAUTION

This device complies with part 15 of the FCC Rules. Operation is subject to the following two conditions: (1) This device may not cause harmful interference, and (2) this device must accept any interference received, including interference that may cause undesired operation.

Changes or modifications not expressly approved by the party responsible for compliance could void the user's authority to operate the equipment.

FCC Interference Statement for Class A EVM devices

NOTE: This equipment has been tested and found to comply with the limits for a Class A digital device, pursuant to part 15 of the FCC Rules. These limits are designed to provide reasonable protection against harmful interference when the equipment is operated in a commercial environment. This equipment generates, uses, and can radiate radio frequency energy and, if not installed and used in accordance with the instruction manual, may cause harmful interference to radio communications. Operation of this equipment in a residential area is likely to cause harmful interference in which case the user will be required to correct the interference at his own expense.

FCC Interference Statement for Class B EVM devices

NOTE: This equipment has been tested and found to comply with the limits for a Class B digital device, pursuant to part 15 of the FCC Rules. These limits are designed to provide reasonable protection against harmful interference in a residential installation. This equipment generates, uses and can radiate radio frequency energy and, if not installed and used in accordance with the instructions, may cause harmful interference to radio communications. However, there is no guarantee that interference will not occur in a particular installation. If this equipment does cause harmful interference to radio or television reception, which can be determined by turning the equipment off and on, the user is encouraged to try to correct the interference by one or more of the following measures:

- Reorient or relocate the receiving antenna.
- Increase the separation between the equipment and receiver.
- Connect the equipment into an outlet on a circuit different from that to which the receiver is connected.
- Consult the dealer or an experienced radio/TV technician for help.

3.2 Canada

3.2.1 For EVMs issued with an Industry Canada Certificate of Conformance to RSS-210

Concerning EVMs Including Radio Transmitters:

This device complies with Industry Canada license-exempt RSS standard(s). Operation is subject to the following two conditions: (1) this device may not cause interference, and (2) this device must accept any interference, including interference that may cause undesired operation of the device.

Concernant les EVMs avec appareils radio:

Le présent appareil est conforme aux CNR d'Industrie Canada applicables aux appareils radio exempts de licence. L'exploitation est autorisée aux deux conditions suivantes: (1) l'appareil ne doit pas produire de brouillage, et (2) l'utilisateur de l'appareil doit accepter tout brouillage radioélectrique subi, même si le brouillage est susceptible d'en compromettre le fonctionnement.

Concerning EVMs Including Detachable Antennas:

Under Industry Canada regulations, this radio transmitter may only operate using an antenna of a type and maximum (or lesser) gain approved for the transmitter by Industry Canada. To reduce potential radio interference to other users, the antenna type and its gain should be so chosen that the equivalent isotropically radiated power (e.i.r.p.) is not more than that necessary for successful communication. This radio transmitter has been approved by Industry Canada to operate with the antenna types listed in the user guide with the maximum permissible gain and required antenna impedance for each antenna type indicated. Antenna types not included in this list, having a gain greater than the maximum gain indicated for that type, are strictly prohibited for use with this device.

Concernant les EVMs avec antennes détachables

Conformément à la réglementation d'Industrie Canada, le présent émetteur radio peut fonctionner avec une antenne d'un type et d'un gain maximal (ou inférieur) approuvé pour l'émetteur par Industrie Canada. Dans le but de réduire les risques de brouillage radioélectrique à l'intention des autres utilisateurs, il faut choisir le type d'antenne et son gain de sorte que la puissance isotrope rayonnée équivalente (p.i.r.e.) ne dépasse pas l'intensité nécessaire à l'établissement d'une communication satisfaisante. Le présent émetteur radio a été approuvé par Industrie Canada pour fonctionner avec les types d'antenne énumérés dans le manuel d'usage et ayant un gain admissible maximal et l'impédance requise pour chaque type d'antenne. Les types d'antenne non inclus dans cette liste, ou dont le gain est supérieur au gain maximal indiqué, sont strictement interdits pour l'exploitation de l'émetteur.

3.3 Japan

3.3.1 *Notice for EVMs delivered in Japan:* Please see http://www.tij.co.jp/lstds/ti_ja/general/eStore/notice_01.page 日本国内に輸入される評価用キット、ボードについては、次のところをご覧ください。
http://www.tij.co.jp/lstds/ti_ja/general/eStore/notice_01.page

3.3.2 *Notice for Users of EVMs Considered "Radio Frequency Products" in Japan:* EVMs entering Japan may not be certified by TI as conforming to Technical Regulations of Radio Law of Japan.

If User uses EVMs in Japan, not certified to Technical Regulations of Radio Law of Japan, User is required by Radio Law of Japan to follow the instructions below with respect to EVMs:

1. Use EVMs in a shielded room or any other test facility as defined in the notification #173 issued by Ministry of Internal Affairs and Communications on March 28, 2006, based on Sub-section 1.1 of Article 6 of the Ministry's Rule for Enforcement of Radio Law of Japan,
2. Use EVMs only after User obtains the license of Test Radio Station as provided in Radio Law of Japan with respect to EVMs, or
3. Use of EVMs only after User obtains the Technical Regulations Conformity Certification as provided in Radio Law of Japan with respect to EVMs. Also, do not transfer EVMs, unless User gives the same notice above to the transferee. Please note that if User does not follow the instructions above, User will be subject to penalties of Radio Law of Japan.

【無線電波を送信する製品の開発キットをお使いになる際の注意事項】 開発キットの中には技術基準適合証明を受けていないものがあります。技術適合証明を受けていないものご使用に際しては、電波法遵守のため、以下のいずれかの措置を取っていただく必要がありますのでご注意ください。

1. 電波法施行規則第6条第1項第1号に基づく平成18年3月28日総務省告示第173号で定められた電波暗室等の試験設備でご使用いただく。
2. 実験局の免許を取得後ご使用いただく。
3. 技術基準適合証明を取得後ご使用いただく。

なお、本製品は、上記の「ご使用にあたっての注意」を譲渡先、移転先に通知しない限り、譲渡、移転できないものとします。

上記を遵守頂けない場合は、電波法の罰則が適用される可能性があることをご留意ください。日本テキサス・インスツルメンツ株式会社
東京都新宿区西新宿 6 丁目 2 4 番 1 号
西新宿三井ビル

3.3.3 *Notice for EVMs for Power Line Communication:* Please see http://www.tij.co.jp/llds/ti_ja/general/eStore/notice_02.page
電力線搬送波通信についての開発キットをお使いになる際の注意事項については、次のところをご覧ください。http://www.tij.co.jp/llds/ti_ja/general/eStore/notice_02.page

4 *EVM Use Restrictions and Warnings:*

4.1 EVMS ARE NOT FOR USE IN FUNCTIONAL SAFETY AND/OR SAFETY CRITICAL EVALUATIONS, INCLUDING BUT NOT LIMITED TO EVALUATIONS OF LIFE SUPPORT APPLICATIONS.

4.2 User must read and apply the user guide and other available documentation provided by TI regarding the EVM prior to handling or using the EVM, including without limitation any warning or restriction notices. The notices contain important safety information related to, for example, temperatures and voltages.

4.3 *Safety-Related Warnings and Restrictions:*

4.3.1 User shall operate the EVM within TI's recommended specifications and environmental considerations stated in the user guide, other available documentation provided by TI, and any other applicable requirements and employ reasonable and customary safeguards. Exceeding the specified performance ratings and specifications (including but not limited to input and output voltage, current, power, and environmental ranges) for the EVM may cause personal injury or death, or property damage. If there are questions concerning performance ratings and specifications, User should contact a TI field representative prior to connecting interface electronics including input power and intended loads. Any loads applied outside of the specified output range may also result in unintended and/or inaccurate operation and/or possible permanent damage to the EVM and/or interface electronics. Please consult the EVM user guide prior to connecting any load to the EVM output. If there is uncertainty as to the load specification, please contact a TI field representative. During normal operation, even with the inputs and outputs kept within the specified allowable ranges, some circuit components may have elevated case temperatures. These components include but are not limited to linear regulators, switching transistors, pass transistors, current sense resistors, and heat sinks, which can be identified using the information in the associated documentation. When working with the EVM, please be aware that the EVM may become very warm.

4.3.2 EVMs are intended solely for use by technically qualified, professional electronics experts who are familiar with the dangers and application risks associated with handling electrical mechanical components, systems, and subsystems. User assumes all responsibility and liability for proper and safe handling and use of the EVM by User or its employees, affiliates, contractors or designees. User assumes all responsibility and liability to ensure that any interfaces (electronic and/or mechanical) between the EVM and any human body are designed with suitable isolation and means to safely limit accessible leakage currents to minimize the risk of electrical shock hazard. User assumes all responsibility and liability for any improper or unsafe handling or use of the EVM by User or its employees, affiliates, contractors or designees.

4.4 User assumes all responsibility and liability to determine whether the EVM is subject to any applicable international, federal, state, or local laws and regulations related to User's handling and use of the EVM and, if applicable, User assumes all responsibility and liability for compliance in all respects with such laws and regulations. User assumes all responsibility and liability for proper disposal and recycling of the EVM consistent with all applicable international, federal, state, and local requirements.

5. *Accuracy of Information:* To the extent TI provides information on the availability and function of EVMs, TI attempts to be as accurate as possible. However, TI does not warrant the accuracy of EVM descriptions, EVM availability or other information on its websites as accurate, complete, reliable, current, or error-free.

6. *Disclaimers:*
- 6.1 EXCEPT AS SET FORTH ABOVE, EVMS AND ANY WRITTEN DESIGN MATERIALS PROVIDED WITH THE EVM (AND THE DESIGN OF THE EVM ITSELF) ARE PROVIDED "AS IS" AND "WITH ALL FAULTS." TI DISCLAIMS ALL OTHER WARRANTIES, EXPRESS OR IMPLIED, REGARDING SUCH ITEMS, INCLUDING BUT NOT LIMITED TO ANY IMPLIED WARRANTIES OF MERCHANTABILITY OR FITNESS FOR A PARTICULAR PURPOSE OR NON-INFRINGEMENT OF ANY THIRD PARTY PATENTS, COPYRIGHTS, TRADE SECRETS OR OTHER INTELLECTUAL PROPERTY RIGHTS.
- 6.2 EXCEPT FOR THE LIMITED RIGHT TO USE THE EVM SET FORTH HEREIN, NOTHING IN THESE TERMS AND CONDITIONS SHALL BE CONSTRUED AS GRANTING OR CONFERRING ANY RIGHTS BY LICENSE, PATENT, OR ANY OTHER INDUSTRIAL OR INTELLECTUAL PROPERTY RIGHT OF TI, ITS SUPPLIERS/LICENSORS OR ANY OTHER THIRD PARTY, TO USE THE EVM IN ANY FINISHED END-USER OR READY-TO-USE FINAL PRODUCT, OR FOR ANY INVENTION, DISCOVERY OR IMPROVEMENT MADE, CONCEIVED OR ACQUIRED PRIOR TO OR AFTER DELIVERY OF THE EVM.
7. *USER'S INDEMNITY OBLIGATIONS AND REPRESENTATIONS.* USER WILL DEFEND, INDEMNIFY AND HOLD TI, ITS LICENSORS AND THEIR REPRESENTATIVES HARMLESS FROM AND AGAINST ANY AND ALL CLAIMS, DAMAGES, LOSSES, EXPENSES, COSTS AND LIABILITIES (COLLECTIVELY, "CLAIMS") ARISING OUT OF OR IN CONNECTION WITH ANY HANDLING OR USE OF THE EVM THAT IS NOT IN ACCORDANCE WITH THESE TERMS AND CONDITIONS. THIS OBLIGATION SHALL APPLY WHETHER CLAIMS ARISE UNDER STATUTE, REGULATION, OR THE LAW OF TORT, CONTRACT OR ANY OTHER LEGAL THEORY, AND EVEN IF THE EVM FAILS TO PERFORM AS DESCRIBED OR EXPECTED.
8. *Limitations on Damages and Liability:*
- 8.1 *General Limitations.* IN NO EVENT SHALL TI BE LIABLE FOR ANY SPECIAL, COLLATERAL, INDIRECT, PUNITIVE, INCIDENTAL, CONSEQUENTIAL, OR EXEMPLARY DAMAGES IN CONNECTION WITH OR ARISING OUT OF THESE TERMS AND CONDITIONS OR THE USE OF THE EVMS PROVIDED HEREUNDER, REGARDLESS OF WHETHER TI HAS BEEN ADVISED OF THE POSSIBILITY OF SUCH DAMAGES. EXCLUDED DAMAGES INCLUDE, BUT ARE NOT LIMITED TO, COST OF REMOVAL OR REINSTALLATION, ANCILLARY COSTS TO THE PROCUREMENT OF SUBSTITUTE GOODS OR SERVICES, RETESTING, OUTSIDE COMPUTER TIME, LABOR COSTS, LOSS OF GOODWILL, LOSS OF PROFITS, LOSS OF SAVINGS, LOSS OF USE, LOSS OF DATA, OR BUSINESS INTERRUPTION. NO CLAIM, SUIT OR ACTION SHALL BE BROUGHT AGAINST TI MORE THAN ONE YEAR AFTER THE RELATED CAUSE OF ACTION HAS OCCURRED.
- 8.2 *Specific Limitations.* IN NO EVENT SHALL TI'S AGGREGATE LIABILITY FROM ANY WARRANTY OR OTHER OBLIGATION ARISING OUT OF OR IN CONNECTION WITH THESE TERMS AND CONDITIONS, OR ANY USE OF ANY TI EVM PROVIDED HEREUNDER, EXCEED THE TOTAL AMOUNT PAID TO TI FOR THE PARTICULAR UNITS SOLD UNDER THESE TERMS AND CONDITIONS WITH RESPECT TO WHICH LOSSES OR DAMAGES ARE CLAIMED. THE EXISTENCE OF MORE THAN ONE CLAIM AGAINST THE PARTICULAR UNITS SOLD TO USER UNDER THESE TERMS AND CONDITIONS SHALL NOT ENLARGE OR EXTEND THIS LIMIT.
9. *Return Policy.* Except as otherwise provided, TI does not offer any refunds, returns, or exchanges. Furthermore, no return of EVM(s) will be accepted if the package has been opened and no return of the EVM(s) will be accepted if they are damaged or otherwise not in a resalable condition. If User feels it has been incorrectly charged for the EVM(s) it ordered or that delivery violates the applicable order, User should contact TI. All refunds will be made in full within thirty (30) working days from the return of the components(s), excluding any postage or packaging costs.
10. *Governing Law:* These terms and conditions shall be governed by and interpreted in accordance with the laws of the State of Texas, without reference to conflict-of-laws principles. User agrees that non-exclusive jurisdiction for any dispute arising out of or relating to these terms and conditions lies within courts located in the State of Texas and consents to venue in Dallas County, Texas. Notwithstanding the foregoing, any judgment may be enforced in any United States or foreign court, and TI may seek injunctive relief in any United States or foreign court.

Mailing Address: Texas Instruments, Post Office Box 655303, Dallas, Texas 75265
Copyright © 2015, Texas Instruments Incorporated

IMPORTANT NOTICE

Texas Instruments Incorporated and its subsidiaries (TI) reserve the right to make corrections, enhancements, improvements and other changes to its semiconductor products and services per JESD46, latest issue, and to discontinue any product or service per JESD48, latest issue. Buyers should obtain the latest relevant information before placing orders and should verify that such information is current and complete. All semiconductor products (also referred to herein as "components") are sold subject to TI's terms and conditions of sale supplied at the time of order acknowledgment.

TI warrants performance of its components to the specifications applicable at the time of sale, in accordance with the warranty in TI's terms and conditions of sale of semiconductor products. Testing and other quality control techniques are used to the extent TI deems necessary to support this warranty. Except where mandated by applicable law, testing of all parameters of each component is not necessarily performed.

TI assumes no liability for applications assistance or the design of Buyers' products. Buyers are responsible for their products and applications using TI components. To minimize the risks associated with Buyers' products and applications, Buyers should provide adequate design and operating safeguards.

TI does not warrant or represent that any license, either express or implied, is granted under any patent right, copyright, mask work right, or other intellectual property right relating to any combination, machine, or process in which TI components or services are used. Information published by TI regarding third-party products or services does not constitute a license to use such products or services or a warranty or endorsement thereof. Use of such information may require a license from a third party under the patents or other intellectual property of the third party, or a license from TI under the patents or other intellectual property of TI.

Reproduction of significant portions of TI information in TI data books or data sheets is permissible only if reproduction is without alteration and is accompanied by all associated warranties, conditions, limitations, and notices. TI is not responsible or liable for such altered documentation. Information of third parties may be subject to additional restrictions.

Resale of TI components or services with statements different from or beyond the parameters stated by TI for that component or service voids all express and any implied warranties for the associated TI component or service and is an unfair and deceptive business practice. TI is not responsible or liable for any such statements.

Buyer acknowledges and agrees that it is solely responsible for compliance with all legal, regulatory and safety-related requirements concerning its products, and any use of TI components in its applications, notwithstanding any applications-related information or support that may be provided by TI. Buyer represents and agrees that it has all the necessary expertise to create and implement safeguards which anticipate dangerous consequences of failures, monitor failures and their consequences, lessen the likelihood of failures that might cause harm and take appropriate remedial actions. Buyer will fully indemnify TI and its representatives against any damages arising out of the use of any TI components in safety-critical applications.

In some cases, TI components may be promoted specifically to facilitate safety-related applications. With such components, TI's goal is to help enable customers to design and create their own end-product solutions that meet applicable functional safety standards and requirements. Nonetheless, such components are subject to these terms.

No TI components are authorized for use in FDA Class III (or similar life-critical medical equipment) unless authorized officers of the parties have executed a special agreement specifically governing such use.

Only those TI components which TI has specifically designated as military grade or "enhanced plastic" are designed and intended for use in military/aerospace applications or environments. Buyer acknowledges and agrees that any military or aerospace use of TI components which have **not** been so designated is solely at the Buyer's risk, and that Buyer is solely responsible for compliance with all legal and regulatory requirements in connection with such use.

TI has specifically designated certain components as meeting ISO/TS16949 requirements, mainly for automotive use. In any case of use of non-designated products, TI will not be responsible for any failure to meet ISO/TS16949.

Products

Audio	www.ti.com/audio
Amplifiers	amplifier.ti.com
Data Converters	dataconverter.ti.com
DLP® Products	www.dlp.com
DSP	dsp.ti.com
Clocks and Timers	www.ti.com/clocks
Interface	interface.ti.com
Logic	logic.ti.com
Power Mgmt	power.ti.com
Microcontrollers	microcontroller.ti.com
RFID	www.ti-rfid.com
OMAP Applications Processors	www.ti.com/omap
Wireless Connectivity	www.ti.com/wirelessconnectivity

Applications

Automotive and Transportation	www.ti.com/automotive
Communications and Telecom	www.ti.com/communications
Computers and Peripherals	www.ti.com/computers
Consumer Electronics	www.ti.com/consumer-apps
Energy and Lighting	www.ti.com/energy
Industrial	www.ti.com/industrial
Medical	www.ti.com/medical
Security	www.ti.com/security
Space, Avionics and Defense	www.ti.com/space-avionics-defense
Video and Imaging	www.ti.com/video

TI E2E Community

e2e.ti.com