

# **AN-1389 Setting Pre-Emphasis Level for DS40MB200 Dual 4Gb/s Mux/Buffer**

---

## **ABSTRACT**

The DS40MB200 is a dual 2:1 multiplexer and 1:2 fan-out repeater designed to support redundancy and extending copper backplane to data rates up to 4 Gb/s. With input equalization and output pre-emphasis, the DS40MB200 is capable of compensating attenuation distortion and reducing deterministic jitter caused by bandwidth-limited transmission lines. This application report outlines the methods to set the proper amount of equalization to achieve optimum jitter performance.

---

## **Contents**

1	Introduction .....	2
2	Transmission Loss .....	3
3	Methods To Determine the Proper Amount of Equalization .....	3
4	Complete Link With Transmit Pre-Emphasis and Receive Equalization .....	5
5	Criteria for Equalization .....	6
6	Conclusion .....	7
7	Reference .....	7

## **List of Figures**

1	Pre-Emphasis Waveforms .....	2
2	Transmission Loss of a 30-Inch FR4 Board Trace .....	4
3	Data Eye After 30-In FR4 Board Trace With Pre-Emphasis Disabled .....	4
4	Data Eye After 30-In FR4 Board Trace With 6 dB of Pre-Emphasis .....	4
5	Data Eye After 30-In FR4 Board Trace – Under Equalized .....	5
6	Data Eye After 30-In FR4 Board Trace – Over Equalized .....	5
7	A Communication Link With DS40MB200 On Both Ends .....	5
8	Transmission Loss of a 20-Inch FR4 Backplane With 2 High Speed Connectors .....	6
9	Data Eye After 20-In Backplane Without Equalization .....	6
10	Data Eye After 20-In Backplane With 3 dB Tx Pre-Emphasis and 5 dB Rx Equalization .....	6
11	Data Eye After an Equalized 20-Inch Backplane in the Presence Of Crosstalk .....	7
12	Bathtub Plot Showing Prediction of Eye Opening at Various Error Rates .....	7

## **List of Tables**

1	Reference Frequencies versus Data Patterns .....	3
2	Reference Frequencies With 8b/10b Code .....	3

# 1 Introduction

Each output driver of the DS40MB200 has pre-emphasis for compensating the transmission loss disparity of the transmission medium that it is driving. **Figure 1** shows the pre-emphasized waveforms before and after a transmission medium. Whenever there is a transition of logic state, the driver sends the first data bit with its full amplitude. In anticipation of lower transmission loss from the transmission medium, the driver sends the subsequent data bits of the same logic state with reduced amplitude. Effectively, the driver conditions the output signal amplitude such that the lower and higher frequency pulses reach approximately the same amplitude at the receiving end of the transmission medium.

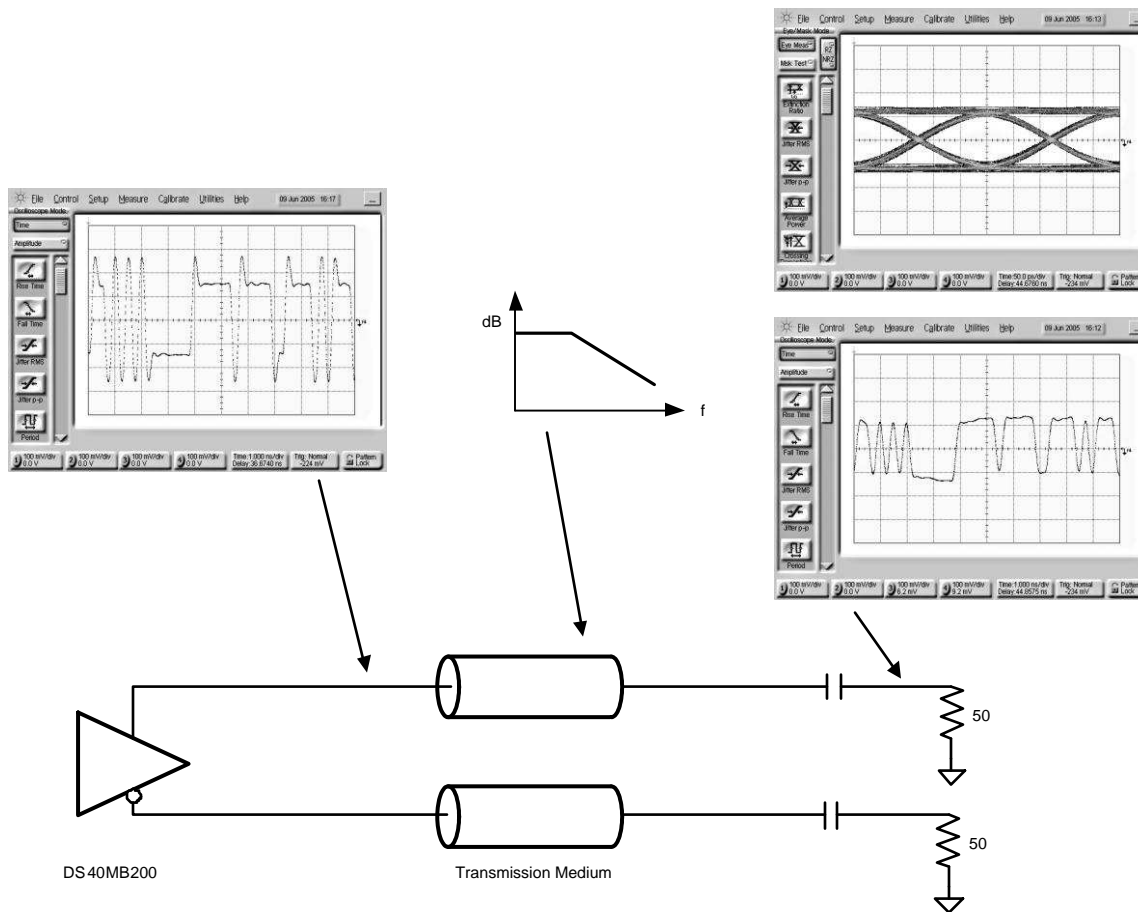

**Figure 1. Pre-Emphasis Waveforms**

Pre-emphasis provides equalization on the driver side. The driver-side equalization minimizes deterministic jitter caused by amplitude disparity of the transmission line. The DS40MB200 provides four steps of user-selectable pre-emphasis ranging from 0, 3, 6 and 9 dB to handle different amount of transmission losses.

Each input stage of the DS40MB200 has a fixed equalizer. It provides boost to higher frequency signals that are attenuated by the transmission loss of the input board trace. The fixed equalizer is designed to equalize about 5 dB of transmission loss disparity from the input transmission line at 4 Gb/s. The input equalizer is capable of providing jitter reduction of about 30 ps caused by a 5 dB transmission loss. For higher transmission loss, driver pre-emphasis provides added equalization. With DS40MB200 on both ends of the transmission medium, they are capable to handle up to 14 dB of transmission loss and enable error free data transmission up to 4 Gb/s.

## 2 Transmission Loss

The proper amount of equalization is determined by the transmission loss of the interconnect elements within the operating frequency range. The spectrum of a bit stream depends on its data pattern. Two reference frequencies are commonly used. The frequency of an alternating-1-0 clock-like pattern is usually used as the upper frequency. Similarly, the frequency of the longest continuous 1's or continuous 0's repeating pattern is used as the lower frequency. The duration for the continuous 1's or continuous 0's is commonly called the Run Length. [Table 1](#) shows the lower and upper frequencies of some commonly used data patterns at which transmission losses are measured. [Table 2](#) shows the lower and upper frequencies of an 8b/10b bit stream at different data rates.

**Table 1. Reference Frequencies versus Data Patterns**

Data Pattern	Run Length	Lower Frequency	Upper Frequency
8b/10b Code	5 Bits	Bit Rate/(2 <sup>5</sup> )	Bit Rate/2
2 <sup>7</sup> -1	7 Bits	Bit Rate/(2 <sup>7</sup> )	Bit Rate/2
2 <sup>10</sup> -1	10 Bits	Bit Rate/(2 <sup>10</sup> )	Bit Rate/2

**Table 2. Reference Frequencies With 8b/10b Code**

Bit Rate	Run Length	Lower Frequency	Upper Frequency
1.25 Gb/s	5 Bits	125 MHz	625 MHz
2.5 Gb/s	5 Bits	250 MHz	1200 MHz
3.125 Gb/s	5 Bits	312.5 MHz	1562.5 MHz
4 Gb/s	5 Bits	400 MHz	2000 MHz

## 3 Methods To Determine the Proper Amount of Equalization

There are many ways to determine the loss of a transmission medium. If a network analyzer is available, it is the most accurate way to sweep the frequency response of the transmission medium. [Figure 2](#) shows the forward transmission characteristics of a 30-inch differential board trace measured by a 4-port network analyzer. Marker 1 (M1) is positioned at the lower frequency, and Marker 2 (M2) is positioned at the upper frequency. The difference in the two markers' positions indicates the transmission loss disparity between its lower and upper frequencies.

A differential Time-Domain Reflectometer (TDR) measures the step response of a transmission medium. The step response at the end of a transmission medium is commonly called the time-domain transmission (TDT) characteristics. There is third-party software that converts the time-domain response to frequency-domain response, from which the transmission losses can be extracted.

In the absence of either a network analyzer or a TDR, a simple way is to send a periodic clock-like data pattern through the transmission medium and measure the transmission loss with an oscilloscope. An alternating-1-0 repeating pattern is used to measure the transmission loss at the upper reference frequency. An alternating-11111-00000 repeating pattern is used to measure the transmission loss at the lower reference frequency for an 8b/10b bit stream. The difference in the losses at the upper and lower reference frequencies is the attenuation distortion that we want to compensate by equalization.

The pre-emphasis level is chosen to compensate the attenuation distortion of the transmission medium. In the case of the 30-inch board trace running 8b/10b code at 4 Gb/s, the attenuation distortion from 400 MHz to 2000 MHz is 5.47 dB (see [Figure 2](#)). The driver is set to provide 6 dB pre-emphasis for properly equalizing the channel. Pre-emphasis of the DS40MB200 is selectable through 2-pin logic controls for 0, 3, 6 and 9 dB. [Figure 3](#) shows the eye diagram at the end of the 30-inch board trace with a (2<sup>7</sup>-1) pseudo-random bit stream running at 4 Gb/s without pre-emphasis. With 6 dB driver pre-emphasis, the data eye is wide open, providing ample of timing and amplitude margins. [Figure 4](#) shows the eye diagram with driver set to 6 dB of pre-emphasis.

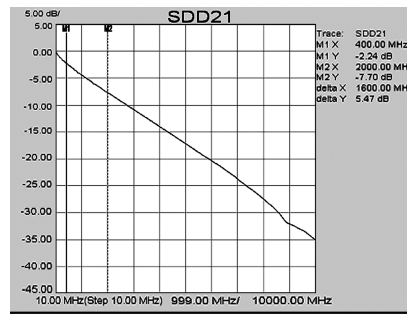

Figure 2. Transmission Loss of a 30-Inch FR4 Board Trace

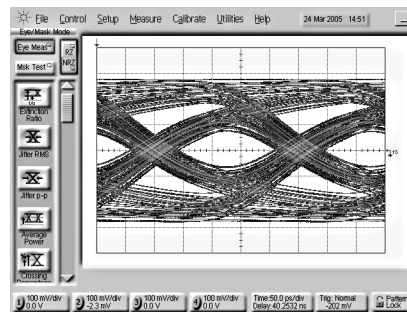

Figure 3. Data Eye After 30-In FR4 Board Trace With Pre-Emphasis Disabled

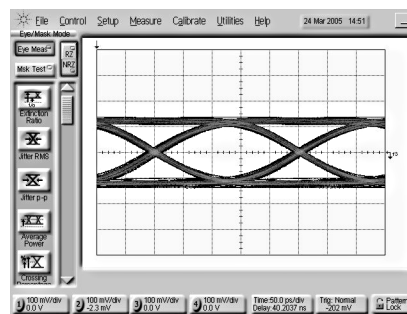

Figure 4. Data Eye After 30-In FR4 Board Trace With 6 dB of Pre-Emphasis

An alternative method to select the proper amount of pre-emphasis is to try out all combinations of pre-emphasis levels and pick the one that offers the lowest jitter and highest eye height performance. This method is by far the simplest approach without even knowing the loss of the transmission medium. With a try-and-error approach, it is important to visually recognize the effect of under-equalization or over-equalization if too little or too much pre-emphasis is applied. Figure 5 shows the eye diagram of the same 30-inch FR4 board trace with driver set to 3 dB pre-emphasis, showing jitter degradation when under-equalization. Figure 6 shows the eye diagram of over-equalization when the amplitude of the higher frequency pulses is higher than that of the lower frequency pulses. Over-equalization usually introduces degradation in eye height.

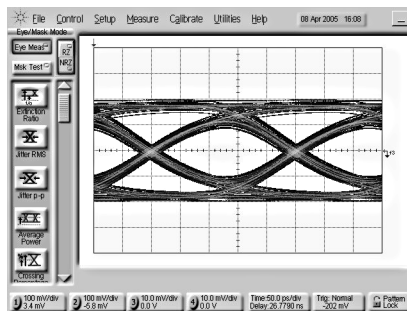

Figure 5. Data Eye After 30-In FR4 Board Trace – Under Equalized

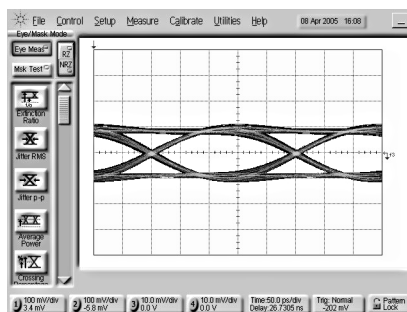

Figure 6. Data Eye After 30-In FR4 Board Trace – Over Equalized

#### 4 Complete Link With Transmit Pre-Emphasis and Receive Equalization

In a communication link where an equalizer is used at the receiver, the total amount of driver pre-emphasis and receiver equalization should be approximately equal to the attenuation distortion of the transmission medium. Figure 7 shows two DS40MB200 signal conditioners on both ends of a 20-inch backplane.

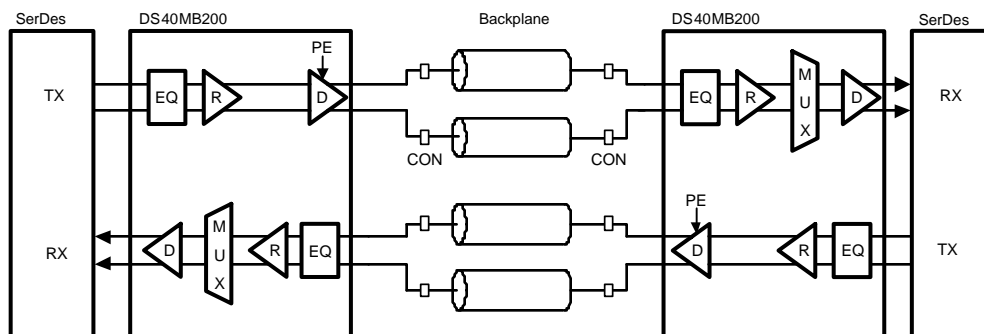

Figure 7. A Communication Link With DS40MB200 On Both Ends

In addition to skin loss and dielectric loss of FR4 board traces, backplane connector and the parasitic capacitance caused by plated-through-holes introduce added losses to the backplane. Figure 8 shows the forward transmission characteristics of a 20-inch FR4 backplane with a high speed backplane connector on both ends. The attenuation distortion for this backplane is about 7.8 dB (see Figure 8). Figure 9 shows the data eye after the backplane without any equalization. Figure 10 shows the data eye opens up with the use of 3 dB driver pre-emphasis and about 5 dB receive equalization from the DS40MB200.

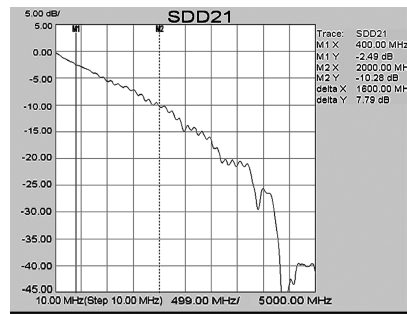

Figure 8. Transmission Loss of a 20-Inch FR4 Backplane With 2 High Speed Connectors

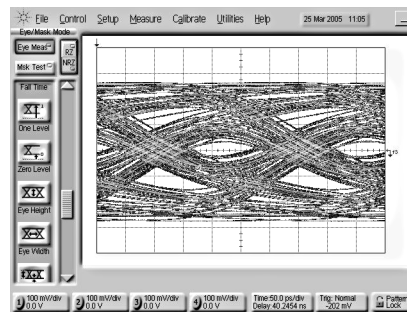

Figure 9. Data Eye After 20-In Backplane Without Equalization

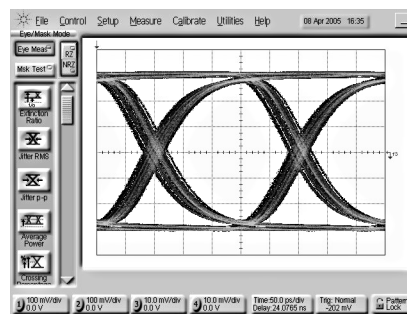

Figure 10. Data Eye After 20-In Backplane With 3 dB Tx Pre-Emphasis and 5 dB Rx Equalization

## 5 Criteria for Equalization

In a typical communication sub-system, in addition to jitter caused by interconnects, there are also jitter components caused by crosstalk, supply noise and other switching noises. They are high frequency jitter components that are usually beyond the bandwidth of a receiver’s phase-locked loop and cannot be filtered by the receiver’s PLL. It is also costly to implement noise cancellation due to circuit complexity and variability of the noise profile. The goal of equalization is to minimize the residual deterministic jitter caused by interconnects and allow enough timing margin for the receiver to tolerate crosstalk and system noise.

The use of equalization achieves the following two goals:

- The total jitter is within the range that a receiver can handle. Most receivers’ PLL have a specification called Input Jitter Tolerance. It spells out the amount of jitter that the PLL can handle under a specific error rate performance.
- The eye height is above the minimum input signal level that the receiver can handle. For DS40MB200, the minimum input level is 100 mV<sub>p-p</sub> differential.



Figure 11 shows the eye diagram of an equalized 20-inch backplane in the presence of crosstalk. Due to the slow acquisition rate of an oscilloscope, an eye diagram taken by an oscilloscope is not adequate to quantify the total jitter introduced by a large number of data transitions. A common practice is to use the bathtub plot feature of a jitter instrument to predict the total jitter at a specific error rate. Figure 12 shows a bathtub plot of the equalized 20-inch backplane, predicting total jitter of 98.4psp-p at an error rate of less than  $10^{-12}$ . This amount of jitter corresponds to 0.394 UI (39.4% of one bit time) at 4 Gb/s. Most receivers' PLL can handle more than 0.5UI of jitter and minimum input signal level of 100 mV<sub>P-P</sub>.

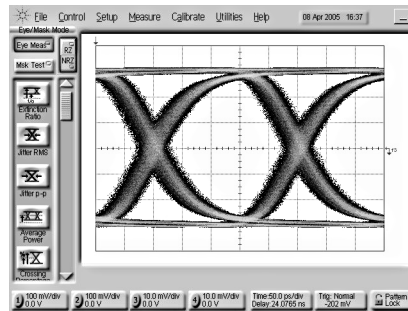

Figure 11. Data Eye After an Equalized 20-Inch Backplane in the Presence Of Crosstalk

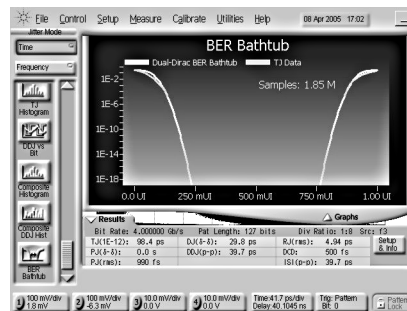

Figure 12. Bathtub Plot Showing Prediction of Eye Opening at Various Error Rates

## 6 Conclusion

DS40MB200 provides user-selectable transmit pre-emphasis and fixed receive equalization that cover a wide range of transmission loss from FR4 board trace, backplane or cables. The DS40MB200 extends the reach and speed of copper transmission media for data rates up to 4 Gb/s.

## 7 Reference

Data sheet of DS40MB200 Dual 4 Gb/s 1:2 Mux/Buffer With Input Equalization and Output Pre-emphasis, National Semiconductor Corp., [www.national.com](http://www.national.com)

4-port network analyzer and Time Domain Reflectometer, Agilent Technology, [www.agilent.com](http://www.agilent.com)

TDR software that extracts transmission loss from TDR, TDA Systems, [www.tdasystems.com](http://www.tdasystems.com)

## IMPORTANT NOTICE

Texas Instruments Incorporated and its subsidiaries (TI) reserve the right to make corrections, enhancements, improvements and other changes to its semiconductor products and services per JESD46, latest issue, and to discontinue any product or service per JESD48, latest issue. Buyers should obtain the latest relevant information before placing orders and should verify that such information is current and complete. All semiconductor products (also referred to herein as "components") are sold subject to TI's terms and conditions of sale supplied at the time of order acknowledgment.

TI warrants performance of its components to the specifications applicable at the time of sale, in accordance with the warranty in TI's terms and conditions of sale of semiconductor products. Testing and other quality control techniques are used to the extent TI deems necessary to support this warranty. Except where mandated by applicable law, testing of all parameters of each component is not necessarily performed.

TI assumes no liability for applications assistance or the design of Buyers' products. Buyers are responsible for their products and applications using TI components. To minimize the risks associated with Buyers' products and applications, Buyers should provide adequate design and operating safeguards.

TI does not warrant or represent that any license, either express or implied, is granted under any patent right, copyright, mask work right, or other intellectual property right relating to any combination, machine, or process in which TI components or services are used. Information published by TI regarding third-party products or services does not constitute a license to use such products or services or a warranty or endorsement thereof. Use of such information may require a license from a third party under the patents or other intellectual property of the third party, or a license from TI under the patents or other intellectual property of TI.

Reproduction of significant portions of TI information in TI data books or data sheets is permissible only if reproduction is without alteration and is accompanied by all associated warranties, conditions, limitations, and notices. TI is not responsible or liable for such altered documentation. Information of third parties may be subject to additional restrictions.

Resale of TI components or services with statements different from or beyond the parameters stated by TI for that component or service voids all express and any implied warranties for the associated TI component or service and is an unfair and deceptive business practice. TI is not responsible or liable for any such statements.

Buyer acknowledges and agrees that it is solely responsible for compliance with all legal, regulatory and safety-related requirements concerning its products, and any use of TI components in its applications, notwithstanding any applications-related information or support that may be provided by TI. Buyer represents and agrees that it has all the necessary expertise to create and implement safeguards which anticipate dangerous consequences of failures, monitor failures and their consequences, lessen the likelihood of failures that might cause harm and take appropriate remedial actions. Buyer will fully indemnify TI and its representatives against any damages arising out of the use of any TI components in safety-critical applications.

In some cases, TI components may be promoted specifically to facilitate safety-related applications. With such components, TI's goal is to help enable customers to design and create their own end-product solutions that meet applicable functional safety standards and requirements. Nonetheless, such components are subject to these terms.

No TI components are authorized for use in FDA Class III (or similar life-critical medical equipment) unless authorized officers of the parties have executed a special agreement specifically governing such use.

Only those TI components which TI has specifically designated as military grade or "enhanced plastic" are designed and intended for use in military/aerospace applications or environments. Buyer acknowledges and agrees that any military or aerospace use of TI components which have **not** been so designated is solely at the Buyer's risk, and that Buyer is solely responsible for compliance with all legal and regulatory requirements in connection with such use.

TI has specifically designated certain components as meeting ISO/TS16949 requirements, mainly for automotive use. In any case of use of non-designated products, TI will not be responsible for any failure to meet ISO/TS16949.

### Products

Audio	<a href="http://www.ti.com/audio">www.ti.com/audio</a>
Amplifiers	<a href="http://amplifier.ti.com">amplifier.ti.com</a>
Data Converters	<a href="http://dataconverter.ti.com">dataconverter.ti.com</a>
DLP® Products	<a href="http://www.dlp.com">www.dlp.com</a>
DSP	<a href="http://dsp.ti.com">dsp.ti.com</a>
Clocks and Timers	<a href="http://www.ti.com/clocks">www.ti.com/clocks</a>
Interface	<a href="http://interface.ti.com">interface.ti.com</a>
Logic	<a href="http://logic.ti.com">logic.ti.com</a>
Power Mgmt	<a href="http://power.ti.com">power.ti.com</a>
Microcontrollers	<a href="http://microcontroller.ti.com">microcontroller.ti.com</a>
RFID	<a href="http://www.ti-rfid.com">www.ti-rfid.com</a>
OMAP Applications Processors	<a href="http://www.ti.com/omap">www.ti.com/omap</a>
Wireless Connectivity	<a href="http://www.ti.com/wirelessconnectivity">www.ti.com/wirelessconnectivity</a>

### Applications

Automotive and Transportation	<a href="http://www.ti.com/automotive">www.ti.com/automotive</a>
Communications and Telecom	<a href="http://www.ti.com/communications">www.ti.com/communications</a>
Computers and Peripherals	<a href="http://www.ti.com/computers">www.ti.com/computers</a>
Consumer Electronics	<a href="http://www.ti.com/consumer-apps">www.ti.com/consumer-apps</a>
Energy and Lighting	<a href="http://www.ti.com/energy">www.ti.com/energy</a>
Industrial	<a href="http://www.ti.com/industrial">www.ti.com/industrial</a>
Medical	<a href="http://www.ti.com/medical">www.ti.com/medical</a>
Security	<a href="http://www.ti.com/security">www.ti.com/security</a>
Space, Avionics and Defense	<a href="http://www.ti.com/space-avionics-defense">www.ti.com/space-avionics-defense</a>
Video and Imaging	<a href="http://www.ti.com/video">www.ti.com/video</a>

### TI E2E Community

[e2e.ti.com](http://e2e.ti.com)