



Ankur Verma, Cole Macias

**ABSTRACT**

The Texas Instruments DS90UB95x-Q1EVM evaluation module (EVM) is a functional board design for evaluating the DS90UB953-Q1 FPD-Link III serializer and the TSER953 V<sup>3</sup>Link serializer. This document provides necessary details for the evaluation such as a brief product overview, quick-start guide, troubleshooting section, schematics, and printed-circuit board (PCB) layout details, and bill of materials (BOM).

The DS90UB953-Q1 and TSER953 serializers represent the next generation in FPD-Link III and V<sup>3</sup>Link serializers and are designed to support high-speed raw data sensors including 2-MP imagers at 60 fps, as well as 4-MP, 30-fps cameras, satellite RADAR, LIDAR, and time-of-flight (ToF) sensors. The chip delivers a 4-Gbps+ forward channel and an ultra-low latency, 50-Mbps bidirectional control channel. The chip also supports power over a single coax (PoC) or shielded twisted-pair (STP) cable and connector. The DS90UB953-Q1 and TSER953 feature advanced data protection and diagnostic features to support ADAS, autonomous driving, and industrial and medical imaging applications. Together with a companion deserializer, the chip delivers precise multi-camera sensor clock and sensor synchronization. For a full list of device characteristics, refer to the [DS90UB953-Q1](#) and [TSER953](#) product folders.

**Table of Contents**

<b>1 Introduction</b> .....	<b>3</b>
<b>2 Quick Start Guide</b> .....	<b>4</b>
<b>3 Troubleshooting</b> .....	<b>7</b>
<b>4 Bill of Materials</b> .....	<b>39</b>
<b>5 PCB Schematics</b> .....	<b>43</b>
<b>6 Board Layout</b> .....	<b>47</b>
<b>7 Related Documentation</b> .....	<b>53</b>
<b>8 Revision History</b> .....	<b>53</b>

**List of Figures**

Figure 1-1. DS90UB95x-Q1EVM Top View.....	3
Figure 2-1. Typical Application Block Diagram Using DS90UB953-Q1 and DS90UB954-Q1 (or variant).....	4
Figure 2-2. DS90UB95x-Q1EVM Major Components.....	5
Figure 2-3. DS90UB95x-Q1EVM With Installed Jumpers.....	5
Figure 2-4. DS90UB954-Q1EVM (or variant) With Jumpers Highlighted.....	6
Figure 3-1. USB2ANY.....	7
Figure 3-2. I2C Pinout of USB2ANY Connector.....	8
Figure 3-3. Launching ALP.....	10
Figure 3-4. Initial ALP Screen.....	10
Figure 3-5. Follow-Up Screen.....	11
Figure 3-6. ALP Information Tab.....	12
Figure 3-7. ALP Registers Tab.....	13
Figure 3-8. ALP Device ID Selected.....	14
Figure 3-9. ALP Device ID Expanded.....	15
Figure 3-10. Writing to Register 0x00 by Checking Bits in ALP.....	15
Figure 3-11. ALP Scripting Tab.....	16
Figure 3-12. Pre-Defined Scripts.....	17
Figure 3-13. Custom Button Creation Step 1.....	18
Figure 3-14. Custom Button Creation Step 2.....	18
Figure 3-15. ALP Scripting Tab.....	21

Figure 3-16. USB2ANY Setup.....	22
Figure 3-17. Remove Incorrect Profile.....	22
Figure 3-18. Add Correct Profile.....	23
Figure 3-19. Finish Setup.....	23
Figure 3-20. ALP No Devices Error.....	24
Figure 3-21. Windows 7, ALP USB2ANY Driver.....	24
Figure 3-22. ALP in Demo Mode.....	25
Figure 3-23. ALP Preferences Menu.....	25
Figure 3-24. Error that States One Instance of This Application Can Be Active in ALP.....	26
Figure 3-25. Ending MainGUI.exe in Task Manager.....	26
Figure 3-26. Error That States That USB2ANY Firmware Must be Updated.....	27
Figure 3-27. USB2ANY Firmware Loader Program Dialog.....	28
Figure 3-28. USB2ANY Without Enclosure.....	29
Figure 3-29. USB2ANY With Enclosure.....	29
Figure 3-30. Verifying DS90UB95x Register.....	30
Figure 3-31. Window for Setting up Scripts in ALP.....	30
Figure 3-32. DS90UB954-Q1EVM (or variant) With Highlighted Jumpers.....	33
Figure 3-33. DS90UB95x-Q1EVM With Installed Jumpers.....	34
Figure 3-34. Test Setup.....	35
Figure 3-35. Setting up Device Profiles in ALP.....	36
Figure 3-36. Navigating to DS90UB954 (or variant) Scripting Tab in ALP.....	36
Figure 3-37. Reading I2C Device ID Within the Register Tab.....	37
Figure 3-38. Verifying Pass and Lock for DS90UB954 (or variant) in ALP.....	37
Figure 3-39. Verifying Camera Initialization in ALP.....	38
Figure 5-1. DS90UB95x-Q1EVM Schematic 1.....	43
Figure 5-2. DS90UB95x-Q1EVM Schematic 2.....	44
Figure 5-3. DS90UB95x-Q1EVM Schematic 3.....	45
Figure 5-4. DS90UB95x-Q1EVM Schematic 4.....	46
Figure 6-1. Top Layer PCB Layout.....	47
Figure 6-2. Top Overlay.....	47
Figure 6-3. Top Paste.....	48
Figure 6-4. Top Solder.....	48
Figure 6-5. Signal Layer 1.....	49
Figure 6-6. Signal Layer 2.....	49
Figure 6-7. Signal Layer 3.....	50
Figure 6-8. Signal Layer 4.....	50
Figure 6-9. Bottom Layer PCB Layout.....	51
Figure 6-10. Bottom Overlay.....	51
Figure 6-11. Bottom Paste.....	52
Figure 6-12. Bottom Solder.....	52

## List of Tables

Table 3-1. Equipment.....	31
Table 4-1. Bill of Materials.....	39

## Trademarks

All trademarks are the property of their respective owners.



## 2 Quick Start Guide

The quick start guide is intended to get the DS90UB95x-Q1EVM operational with the minimum amount of information. See [Section 3.5](#) in the troubleshooting section for in-depth, step-by-step instructions.

### 2.1 System Requirements

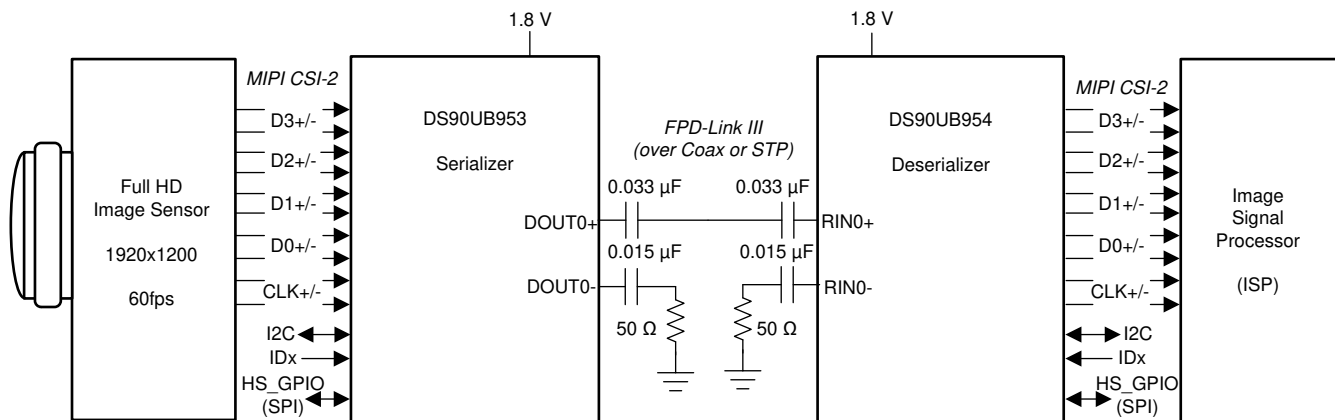
The major components of the DS90UB95x-Q1EVM are:

- DS90UB95xSerializer Board
- On-board Power-over-Coax (PoC) interface
- FAKRA connector for digital video, power, and diagnostics
- On-board I2C programming interface

To demonstrate, TI recommends the following (not included):

- DS90UB954-Q1EVM (or variant)
- One DACAR/FAKRA coax cable
- DC power supply for DS90UB954-Q1EVM (or variant) only
- Power supply cables: for example, banana to coax, banana to grabber, and so forth.
- Two male USB-to-mini USB cables
- USB2ANY or an Aardvark I2C/SPI Host Adapter
- Analog LaunchPAD software (download [Analog Launch PAD](#) from TI.com (a myTI Login required). Steps for installation can be found in [Section 3.3](#)). This software is not required if an external ECU is used.

### 2.2 Application Block Diagram



**Figure 2-1. Typical Application Block Diagram Using DS90UB953-Q1 and DS90UB954-Q1 (or variant)**

## 2.3 Major Components of DS90UB95x-Q1EVM

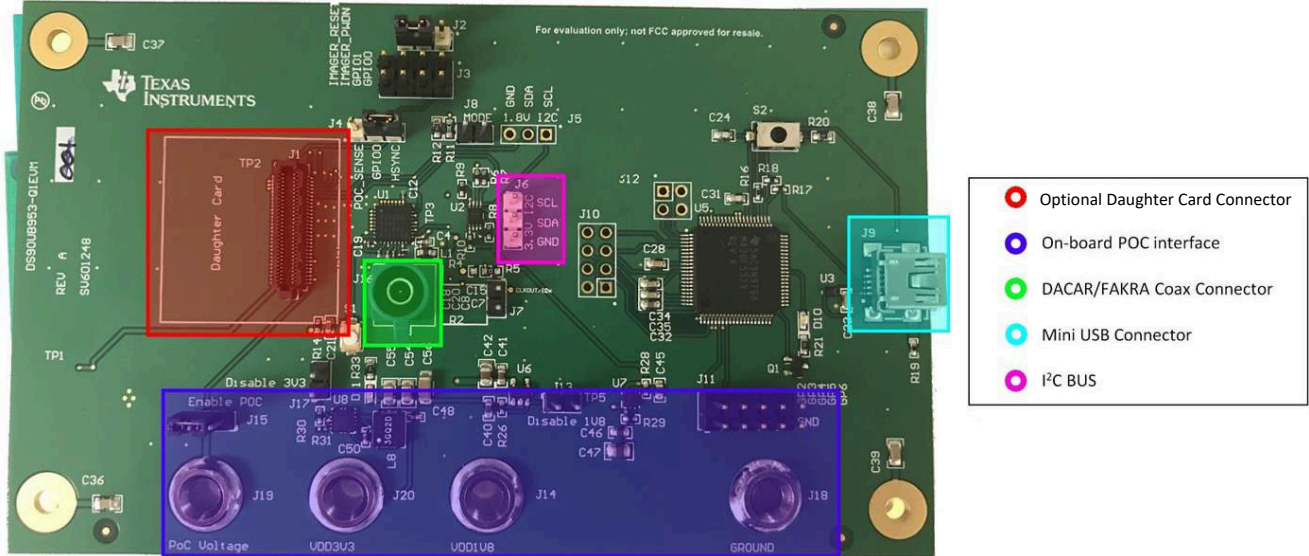


Figure 2-2. DS90UB95x-Q1EVM Major Components

## 2.4 Demo Instructions for DS90UB95x-Q1EVM

1. Ensure jumpers on J2, J4, and J15 for DS90UB95x-Q1EVM are installed as shown in [Figure 2-3](#)

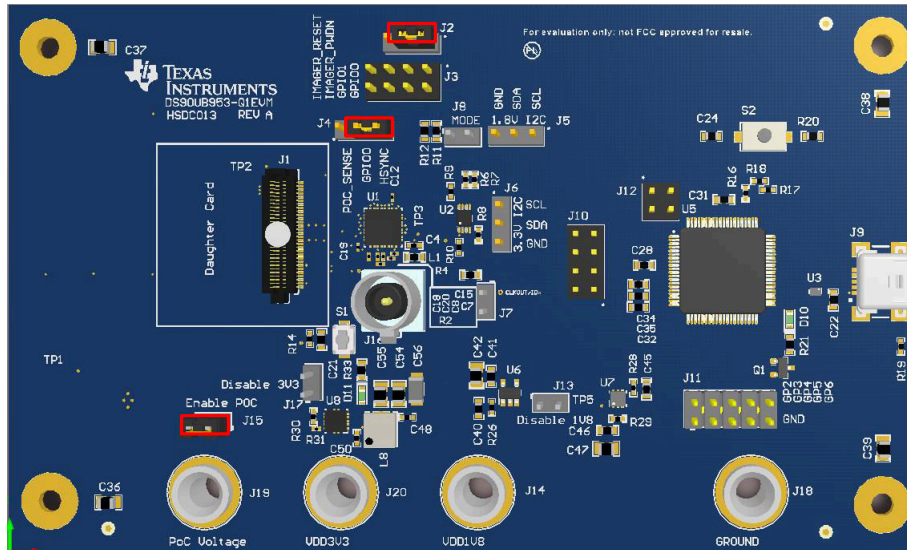


Figure 2-3. DS90UB95x-Q1EVM With Installed Jumpers



## 3 Troubleshooting

### 3.1 Default Addresses

The default 9-bit I2C address of DS90UB95xis set to 0x30 (011 0000) using suitable resistor divider on ID[x] pin. Also, 8-bit I2C address of DS90UB954 (or variant) is set to 0x7A (0111 1010) using suitable resistor dividers on pins IDX[0] and IDX[1].

### 3.2 USB2ANY

The USB2ANY is required to work with any interactive GUI over I2C, such as ALP (Analog LaunchPAD). Download and install ALP from: <http://www.ti.com/tool/ALP>.

The USB2ANY is shown in [Figure 3-1](#). It is powered through the USB port of computer.



**Figure 3-1. USB2ANY**

There are two methods to use the USB2ANY to communicate with the 953/954 EVMs. The first method is to simply connect the USB to Mini-USB cable to the USB port of your computer and the Mini-USB ports on the EVMs, J9 for the 953 EVM (see [Figure 2-2](#)) and J2 on the 954 EVM. If using the first method, skip to [Section 3.3](#). The second method is to use the pinout of the USB2ANY. [Figure 3-2](#) shows the USB2ANY pinout with the I2C pins highlighted. Typically, jumper wires are used to connect these to the 953/954 EVMs.

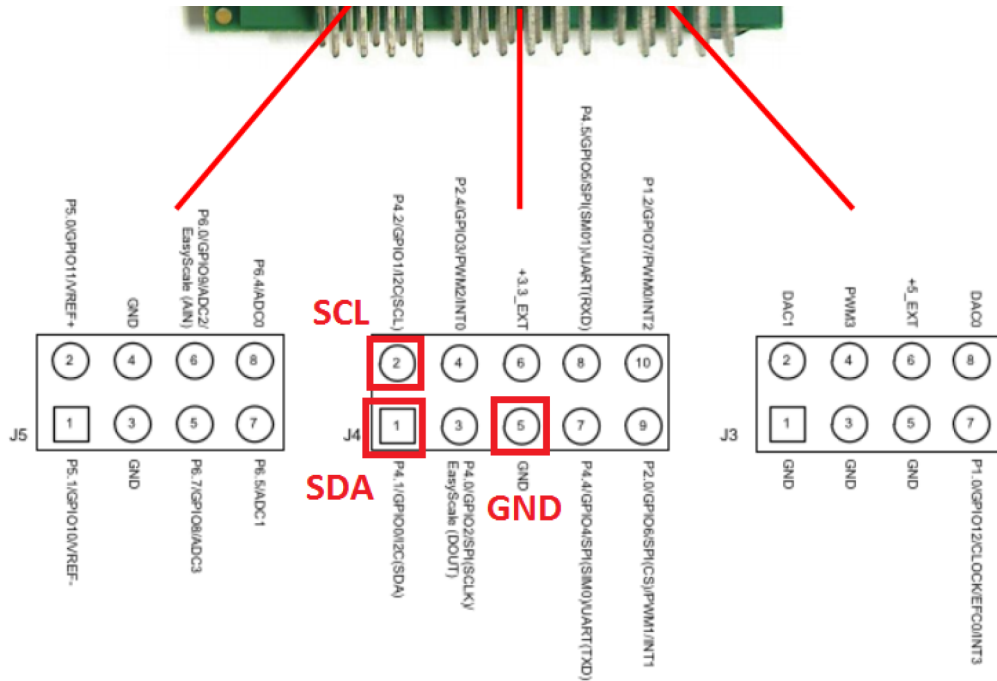


Figure 3-2. I2C Pinout of USB2ANY Connector

On the DS90UB954-Q1EVM (or variant), connect the other ends of the corresponding wires to pins 2, 3, and 4 of J25 labeled SCL, SDA, and GND, respectively.

On the DS90UB95x-Q1EVM, connect the other ends of the corresponding wires to pins 1, 2, and 3 of J5 for 1.8 V, or J6 for 3.3 V labeled SCL, SDA, and GND, respectively. Note that these voltages refer to the pullup voltage used in I2C communication. As a result, check the mode of the I2C adapter before plugging in to the adapter.

Connecting the Mini USB to USB cable from the port of the USB2ANY to the computer should allow ALP to communicate with the EVM. However, if the EVMs are configured to have 1.8 V I2C signal levels (see J5 on the 953 EVM and J16 on the 954 EVM), the USB2ANY must be configured to support the 1.8 V required by the DS90UB95x-Q1EVM and DS90UB954-Q1EVM (or variant). To do this, the user must navigate to the USB2ANY.py script and change the code. The path to the file is given below:

```
C:\Program Files (x86)\Texas Instruments\Analog LaunchPAD
v1.56.0010\Drivers\i2c_controllers\usb2any\python
```

Once the usb2any\_lib.py script is found, open the script in a text editing program (for example, Notepad, Wordpad, Notepad++, and so forth) and replace Line 61 from:

```
self.usb2anydll.u2aI2C_Control(self.u2ahandle,1,0,0)
```

To the following:

```
self.usb2anydll.u2aI2C_Control(self.u2ahandle,1,0,1)
self.usb2anydll.u2aPower_WriteControl(self.u2ahandle,1,0)
```

Save the script, close the program, and ALP will now recognize the connection from the board to the USB2ANY.



## 3.3 ALP Software Setup

### Note

The ALP Software Setup example used in this section refers to several FPD-Link parts. Specific screenshots may not be for the DS90UB954-Q1 or DS90UB953-Q1, however, the process remains the same for using the DS90UB95x-Q1EVM and DS90UB954-Q1EVM.

### 3.3.1 System Requirements

<b>Operating System:</b>	Windows 7 64-bit
<b>USB:</b>	USB2ANY
<b>USB2ANY Firmware Version:</b>	2.5.2.0
<b>USB:</b>	Aardvark I <sup>2</sup> C/SPI host adapter p/n TP240141

### 3.3.2 Download Contents

The latest TI Analog LaunchPAD can be downloaded from: <http://www.ti.com/tool/alp>.

Download and extract the zip file to a temporary location that can be deleted later.

The following installation instructions are for a PC running Windows 7 64-bit Operating System.

### 3.3.3 Installation of the ALP Software

Execute the ALP Setup Wizard program called *ALPF\_setup\_v\_x\_x\_x.exe* that was extracted to a temporary location on the local drive of your PC.

There are 7 steps to the installation once the setup wizard is started:

1. Select the *Next* button.
2. Select *I accept the agreement* and then select the *Next* button.
3. Select the location to install the ALP software and then select the *Next* button.
4. Select the location for the start menu shortcut and then select the *Next* button.
5. There will then be a screen that allows the creation of a desktop icon. After selecting the desired choices select the *Next* button.
6. Select the *Install* button, and the software will then be installed to the selected location.
7. Uncheck *Launch Analog LaunchPAD* and select the *Finish* button. The ALP software will start if *Launch Analog LaunchPAD* is checked, but it will not be useful until the USB driver is installed and board is attached.

Power the DS90UB95x-Q1 EVM board with a 12-VDC power supply.

### 3.3.4 Start-Up - Software Description

Make sure all the software has been installed and the hardware is powered on and connected to the PC. Execute *Analog LaunchPAD* shortcut from the start menu. The default start menu location is under All Programs > Texas Instruments > Analog LaunchPAD vx.x.x > Analog LaunchPAD to start MainGUI.exe.



Figure 3-3. Launching ALP

The application should come up in the state shown in [Figure 3-4](#). If it does not, see [Section 3.4](#).

Under the Devices tab, click twice on the DS90UB95x to select the device to open the device profile and its associated tabs. If the incorrect profile is shown, consult [Section 3.4.1](#).

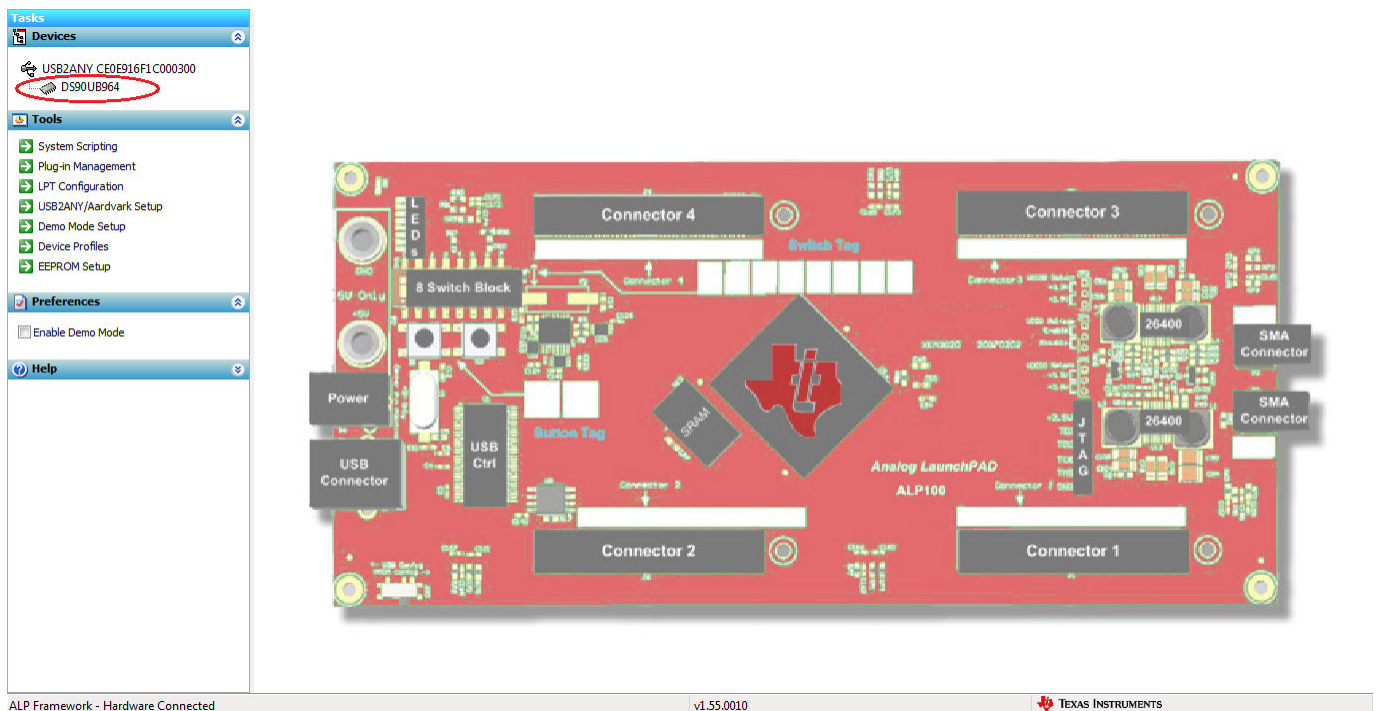
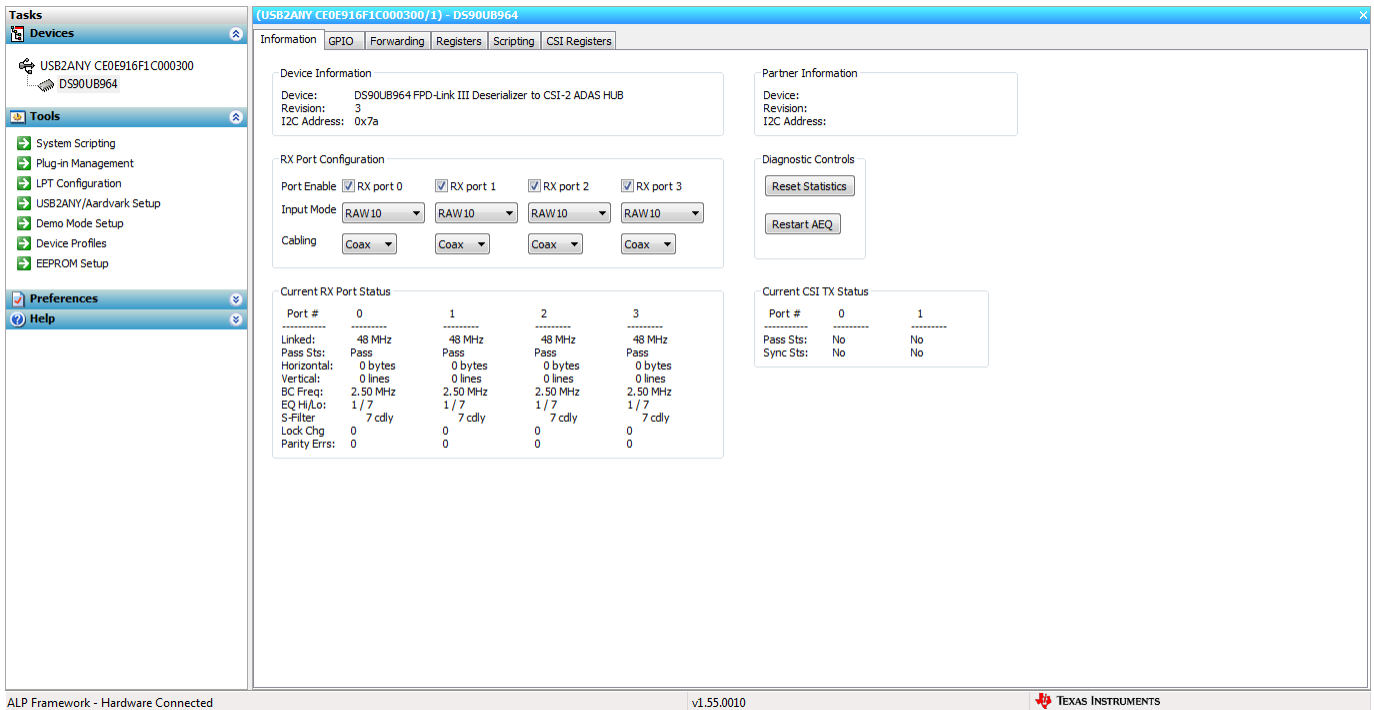


Figure 3-4. Initial ALP Screen

After selecting the DS90UB95x, the following screen shown in [Figure 3-5](#) should appear.



The screenshot shows the 'Follow-Up Screen' for the device DS90UB964. The interface includes a left-hand navigation pane with sections for 'Tasks', 'Devices', 'Tools', 'Preferences', and 'Help'. The main area is titled '(USB2ANY CE0E916F1C000300/1) - DS90UB964' and contains several configuration and diagnostic panels.

**Information** | GPIO | Forwarding | Registers | Scripting | CSI Registers

**Device Information**  
 Device: DS90UB964 FPD-Link III Deserializer to CSI-2 ADAS HUB  
 Revision: 3  
 I2C Address: 0x7a

**Partner Information**  
 Device:  
 Revision:  
 I2C Address:

**RX Port Configuration**  
 Port Enable:  RX port 0  RX port 1  RX port 2  RX port 3  
 Input Mode: RAW10 RAW10 RAW10 RAW10  
 Cabling: Coax Coax Coax Coax

**Diagnostic Controls**  
 Reset Statistics  
 Restart AEQ

**Current RX Port Status**

Port #	0	1	2	3
Linked:	48 MHz	48 MHz	48 MHz	48 MHz
Pass Sts:	Pass	Pass	Pass	Pass
Horizontal:	0 bytes	0 bytes	0 bytes	0 bytes
Vertical:	0 lines	0 lines	0 lines	0 lines
BC Freq:	2.50 MHz	2.50 MHz	2.50 MHz	2.50 MHz
EQ H/L:	1 / 7	1 / 7	1 / 7	1 / 7
S-Filter	7 cddy	7 cddy	7 cddy	7 cddy
Lock Chg	0	0	0	0
Parity Errs:	0	0	0	0

**Current CSI TX Status**

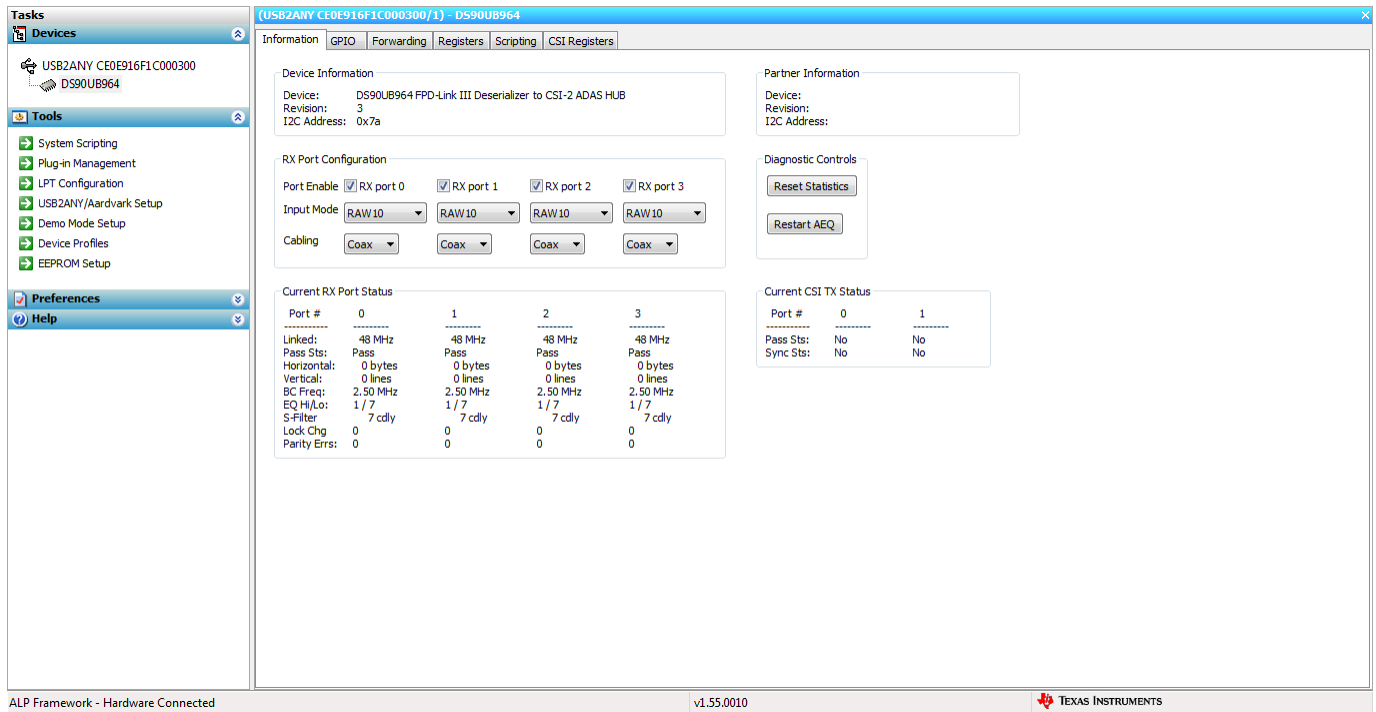
Port #	0	1
Pass Sts:	No	No
Sync Sts:	No	No

ALP Framework - Hardware Connected | v1.55.0010 | TEXAS INSTRUMENTS

Figure 3-5. Follow-Up Screen

### 3.3.5 Information Tab

The Information tab is shown in [Figure 3-6](#).



**Tasks**  
**Devices**  
 USB2ANY CE0E916F1C000300  
 DS90UB964  
**Tools**  
 System Scripting  
 Plug-in Management  
 LPT Configuration  
 USB2ANY/Aardvark Setup  
 Demo Mode Setup  
 Device Profiles  
 EEPROM Setup  
**Preferences**  
**Help**

**(USB2ANY CE0E916F1C000300/1) - DS90UB964**  
 Information | GPIO | Forwarding | Registers | Scripting | CSI Registers

**Device Information**  
 Device: DS90UB964 FPD-Link III Deserializer to CSI-2 ADAS HUB  
 Revision: 3  
 I2C Address: 0x7a

**Partner Information**  
 Device:  
 Revision:  
 I2C Address:

**RX Port Configuration**  
 Port Enable:  RX port 0  RX port 1  RX port 2  RX port 3  
 Input Mode: RAW10 RAW10 RAW10 RAW10  
 Cabling: Coax Coax Coax Coax

**Diagnostic Controls**  
 Reset Statistics  
 Restart AEQ

**Current RX Port Status**

Port #	0	1	2	3
Linked:	48 MHz	48 MHz	48 MHz	48 MHz
Pass Sts:	Pass	Pass	Pass	Pass
Horizontal:	0 bytes	0 bytes	0 bytes	0 bytes
Vertical:	0 lines	0 lines	0 lines	0 lines
BC Freq:	2.50 MHz	2.50 MHz	2.50 MHz	2.50 MHz
EQ H/L/O:	1/7	1/7	1/7	1/7
S-Filter	7 cdly	7 cdly	7 cdly	7 cdly
Lock Chg	0	0	0	0
Parity Errs:	0	0	0	0

**Current CSI TX Status**

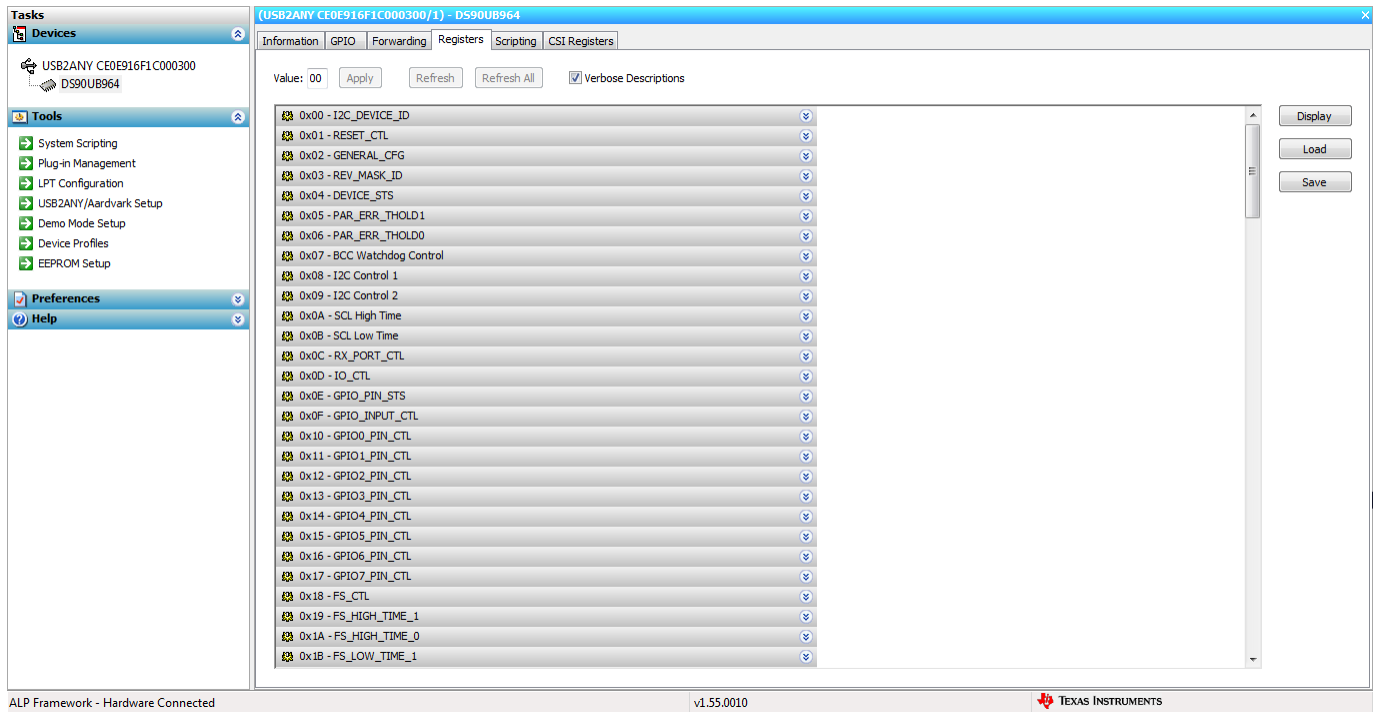
Port #	0	1
Pass Sts:	No	No
Sync Sts:	No	No

ALP Framework - Hardware Connected | v1.55.0010 | TEXAS INSTRUMENTS

**Figure 3-6. ALP Information Tab**

### 3.3.6 Registers Tab

The Register tab is shown in [Figure 3-7](#).



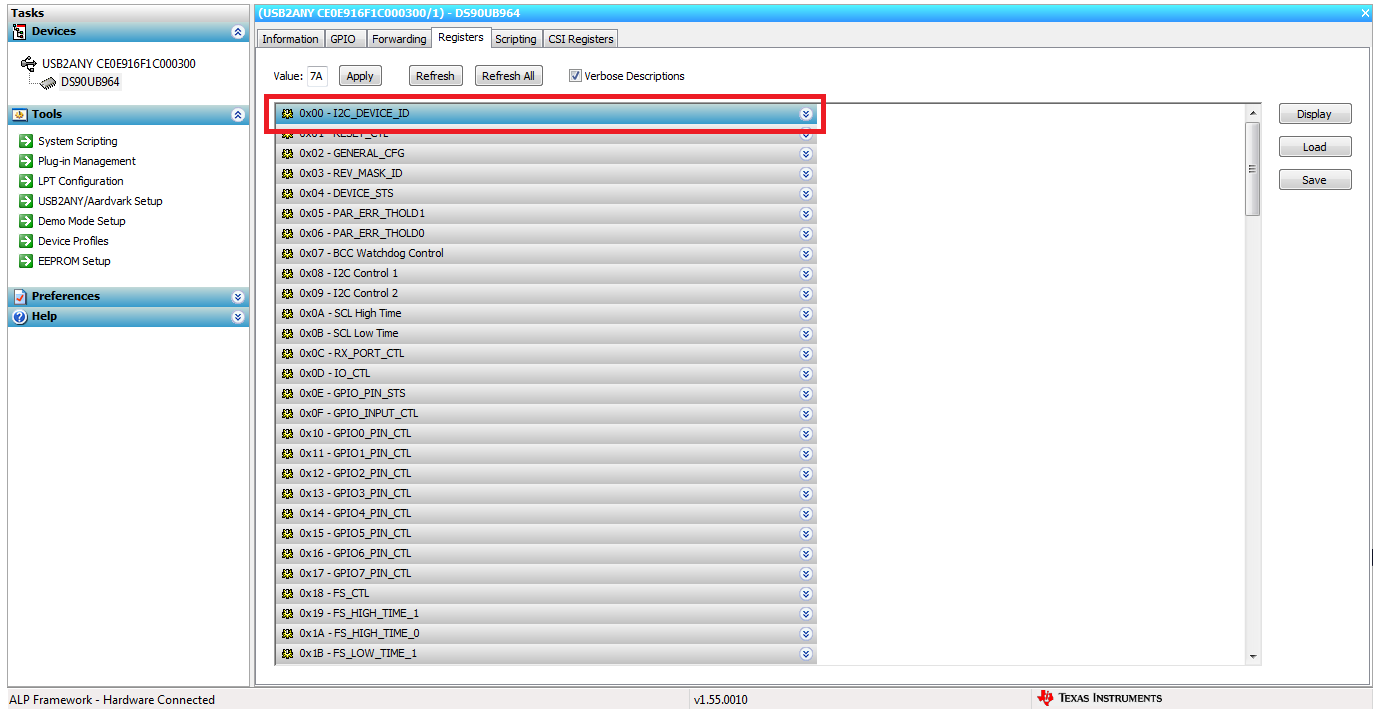
**Figure 3-7. ALP Registers Tab**

### 3.3.7 Registers Tab - Address 0x00 Selected

Figure 3-8 shows Address 0x00 selected. Note that the *Value:* box, of that register.

Value: **7A**

, will now show the hex value




**Figure 3-8. ALP Device ID Selected**

### 3.3.8 Registers Tab - Address 0x00 Expanded

By double clicking on the Address bar



or a single click on , the expanded Address 0x00 reveals contents by bits. Any register address displayed can be expanded.

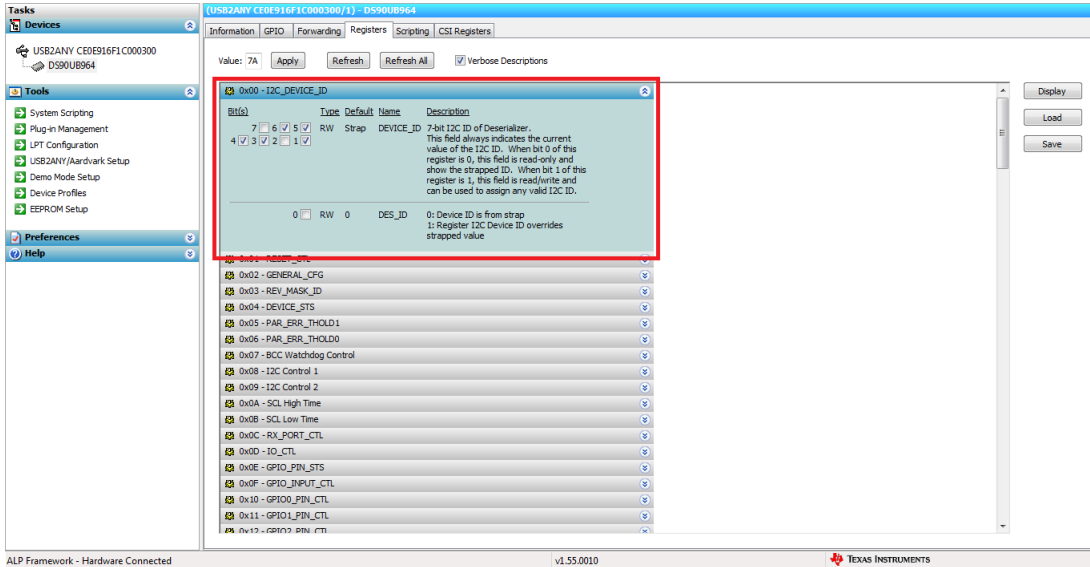


Figure 3-9. ALP Device ID Expanded

Type

Any RW Type register, **RW**, can be written into by writing the hex value into the *Value:* box, **Value: 00** or putting the pointer into the individual register bit(s) box by a left mouse click to put a check mark (indicating a 1) or unchecking to remove the check mark (indicating a 0). Click the *Apply* button to write to the register, and *refresh* to see the new value of the selected (highlighted) register.

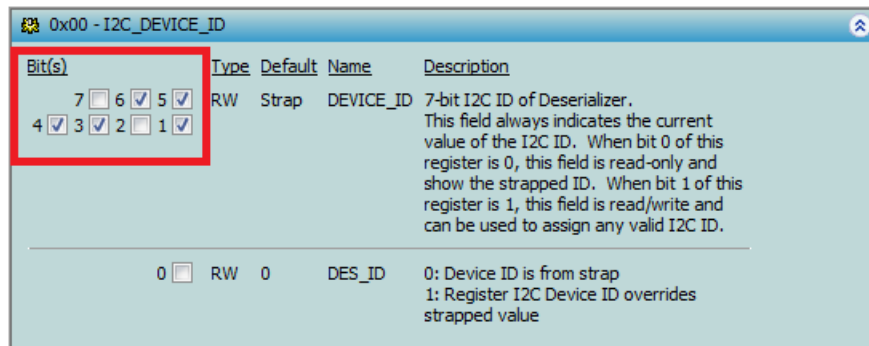


Figure 3-10. Writing to Register 0x00 by Checking Bits in ALP

The box toggles on every mouse click.

### 3.3.9 Scripting Tab

Figure 3-11 shows the Scripting tab. The script window provides a full Python scripting environment which can be for running scripts and interacting with the device in an interactive or automated fashion. Commands may be written directly into the Scripting tab or may be run from a .py file using the "Run" button. Example scripts may be found using the "Run PreDef Script" button.

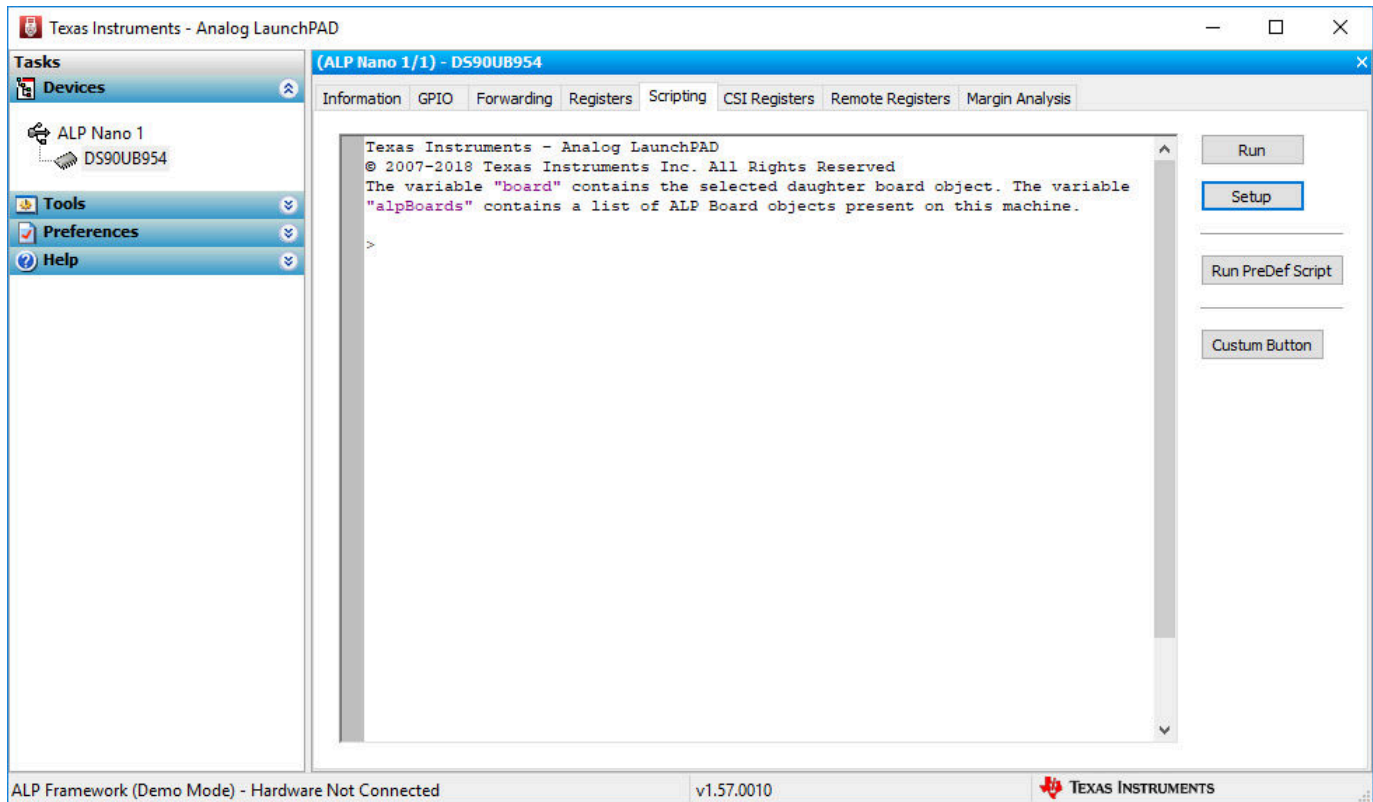
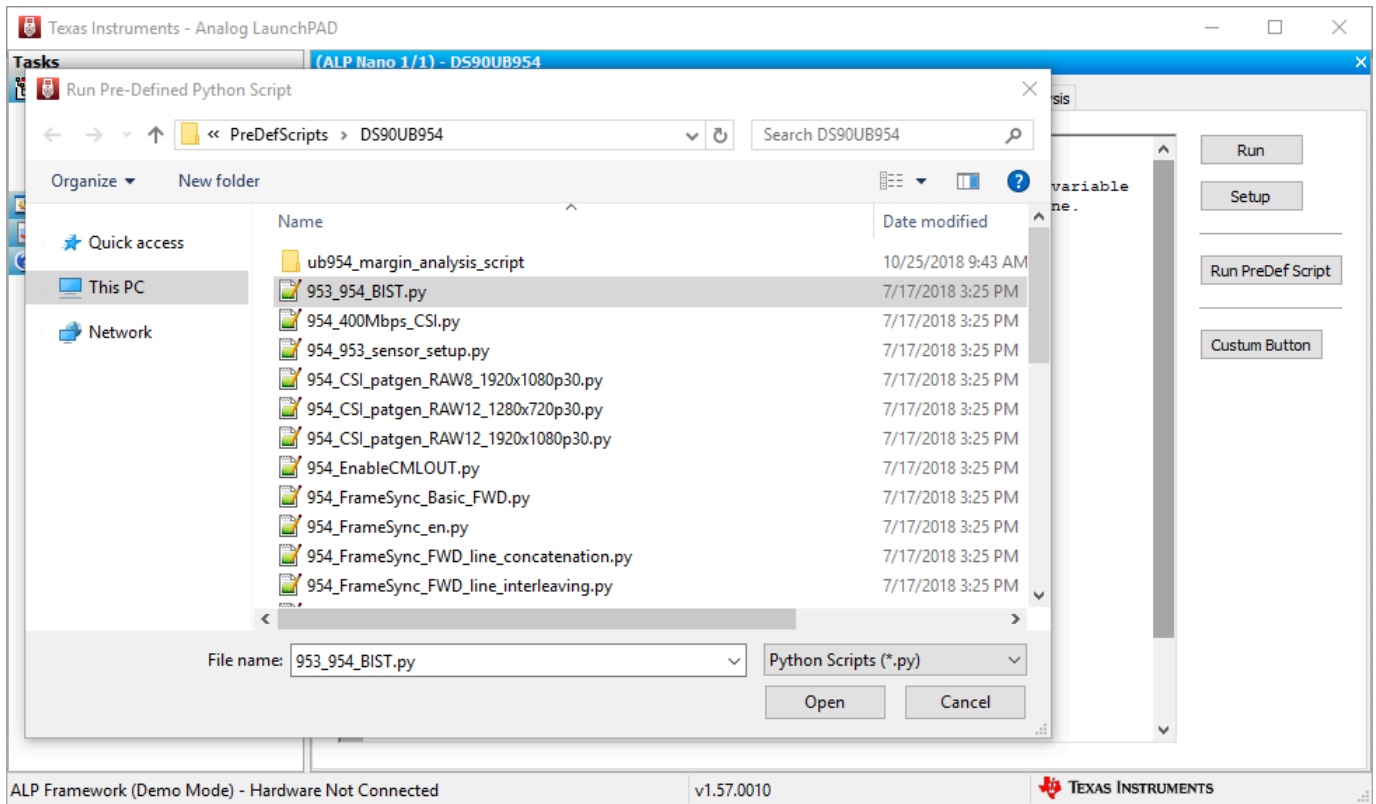


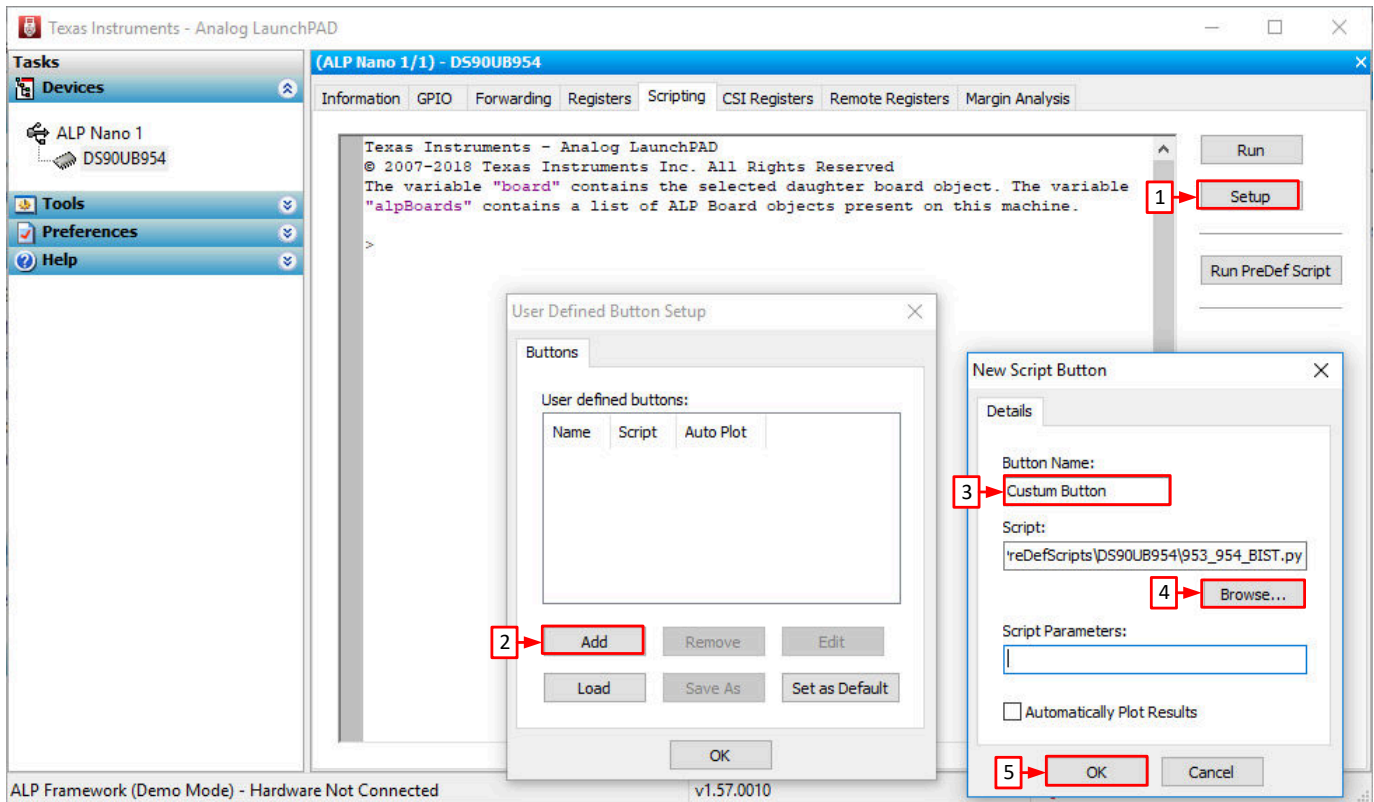
Figure 3-11. ALP Scripting Tab



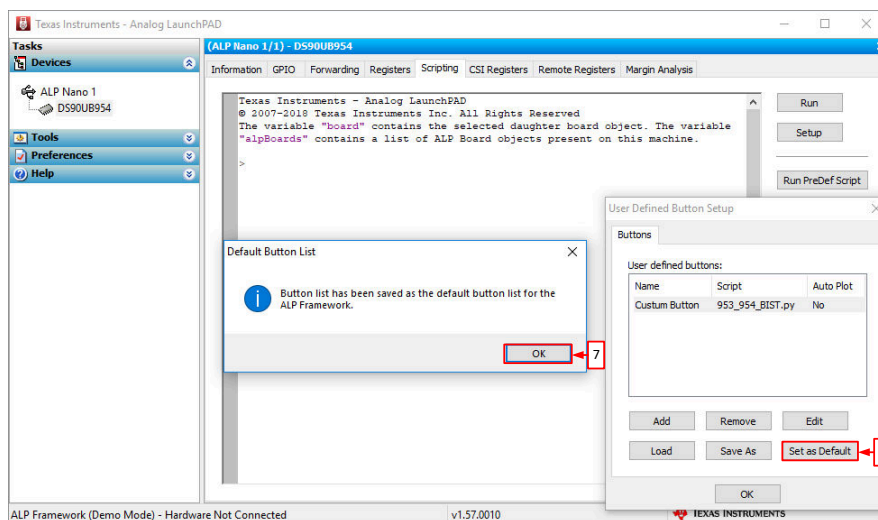


**Figure 3-12. Pre-Defined Scripts**

It is also possible to create custom buttons on the Scripting tab to run a desired script. To do so, click on the "Setup" button, then say "Add", and select the desired name and script. To make the button appear in future instances of ALP, click the "Set As Default" button.



**Figure 3-13. Custom Button Creation Step 1**



**Figure 3-14. Custom Button Creation Step 2**

**WARNING**

Directly interacting with devices either through register modifications or calling device support library functions can effect the performance and/or functionality of the user interface and may even crash the ALP Framework application.

**3.3.9.1 Example Functions**

The following are Python functions commonly used to interact with FPD-Link devices.

### 3.3.9.1.1 Local I2C Reads/Writes

These functions will perform reads and writes only for the I2C assigned to board.devAddr, which by default will be the detected address for the DS90UB954-Q1 (or variant).

**board.ReadReg(Register Address , # of Bytes) OR board.ReadReg(Register Address)** I2C Read Command

- Accepts both hex & decimal inputs
- Number of bytes will default to 1 if omitted
- Ex: board.ReadReg(0x00) will return the value in Register 0 for the local device

**board.WriteReg(Register Address , Data)** I2C Write Command

- Accepts both hex & decimal inputs
- Ex: board.WriteReg(0x01, 0x01) will set Register 0 to have a value of 1

**board.devAddr = [I2C Address]** Assigns I2C address to be used for board.ReadReg and board.WriteReg commands

- Accepts both hex & decimal inputs
- Uses the 8-bit form of the I2C address
- Can be used to shorten read/write commands
- Ex: board.devAddress = 0x60 sets the board address to 0x60

### 3.3.9.1.2 General I2C Reads/Writes:

These I2C commands will work for any I2C address on the local bus and remote devices configured in the slave ID and slave alias registers of the device. The 8-bit form of I2C addresses should be used.

**board.ReadI2C(Device Address, Register Address , # of Bytes) OR board.ReadI2C(Device Address, Register Address)** I2C Read Command

- Accepts both hex & decimal inputs
- Number of bytes will default to 1 if omitted
- Ex: board.ReadI2C(0x60, 0x00) will return the value in Register 0 for the device with address 0x60 (8-bit form)

**board.WriteI2C(Device Address, Register Address , Data)** I2C Write Command

- Accepts both hex & decimal inputs
- Ex: board.WriteI2C(0x60, 0x01, 0x01) will set Register 1 of the device with address 0x60 (8-bit form) to have a value of 1

### 3.3.9.1.3 I2C Reads/Writes with Multi-Byte Register Addresses

These I2C commands will work for any I2C address on the local bus and remote devices configured in the slave ID and slave alias registers of the device. The 8-bit form of I2C addresses should be used.

**board.ReadI2C(Device Address, Register Address Byte 2, [Register Address Byte 1, # of Bytes])**  
**OR board.ReadI2C(Device Address, Register Address Byte 2, [Register Address Byte 1])**

I2C Read Command for devices with multi-byte register addresses

- Accepts both hex & decimal inputs
- Number of bytes will default to 1 if omitted
- Ex: board.ReadI2C(0x60, 0x30, [0x00]) will return the value in Register 0x3000 for the device with address 0x60 (8-bit form)

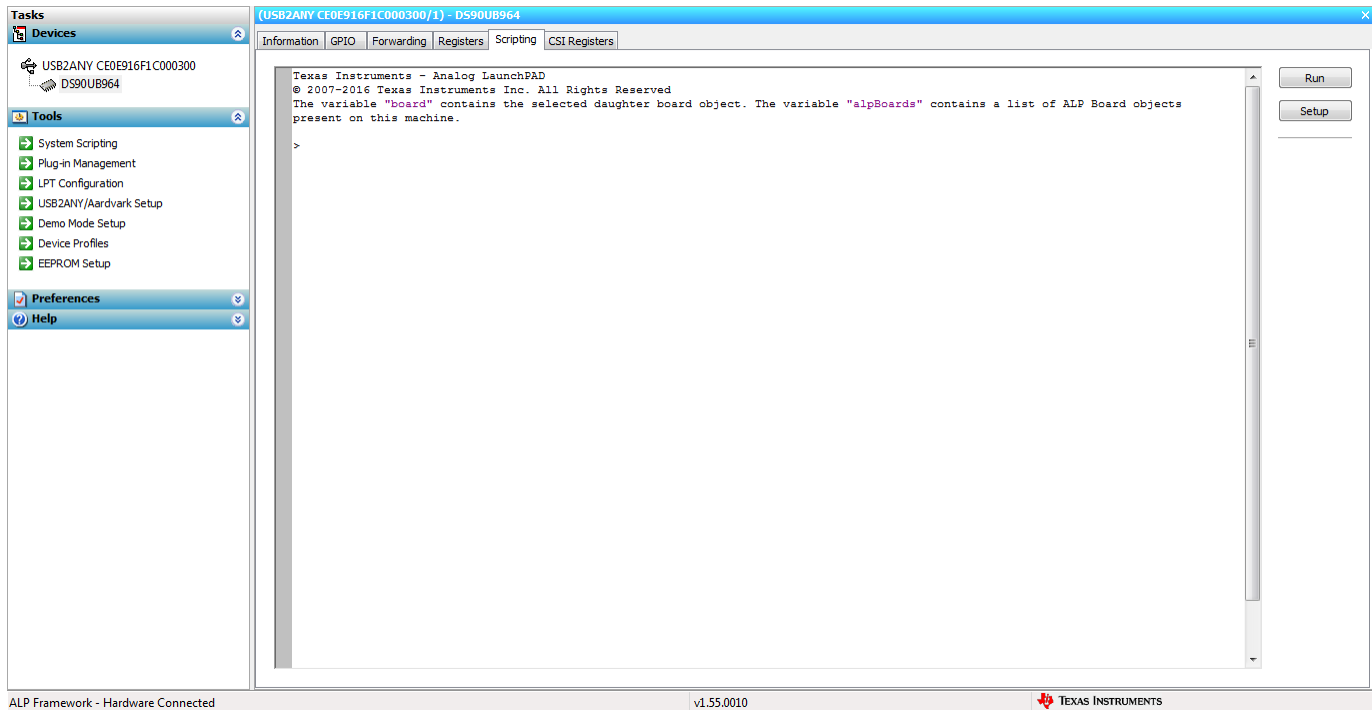
**board.WriteI2C(Device Address, Register Address Byte 2, [Register Address Byte 1, Data])**

I2C Write Command for devices with multi-byte register addresses

- Accepts both hex & decimal inputs
- Number of bytes will default to 1 if omitted
- Ex: board.WriteI2C(0x60, 0x30, [0x01, 0x01]) will set Register 0x3000 of the device with address 0x60 (8-bit form) to have a value of 1

### 3.3.10 Scripting Tab

The Scripting tab is shown in [Figure 3-15](#).



**Figure 3-15. ALP Scripting Tab**

The script window provides a full Python scripting environment which can be for running scripts and interacting with the device in an interactive or automated fashion.

**WARNING**

Directly interacting with devices either through register modifications or calling device support library functions can effect the performance and/or functionality of the user interface and may even crash the ALP Framework application.

### 3.4 Troubleshooting ALP Software

#### 3.4.1 ALP Loads the Incorrect Profile

If ALP opens with the incorrect profile loaded the correct profile can be loaded from the USB2ANY/Aardvark Setup found under the tools menu.

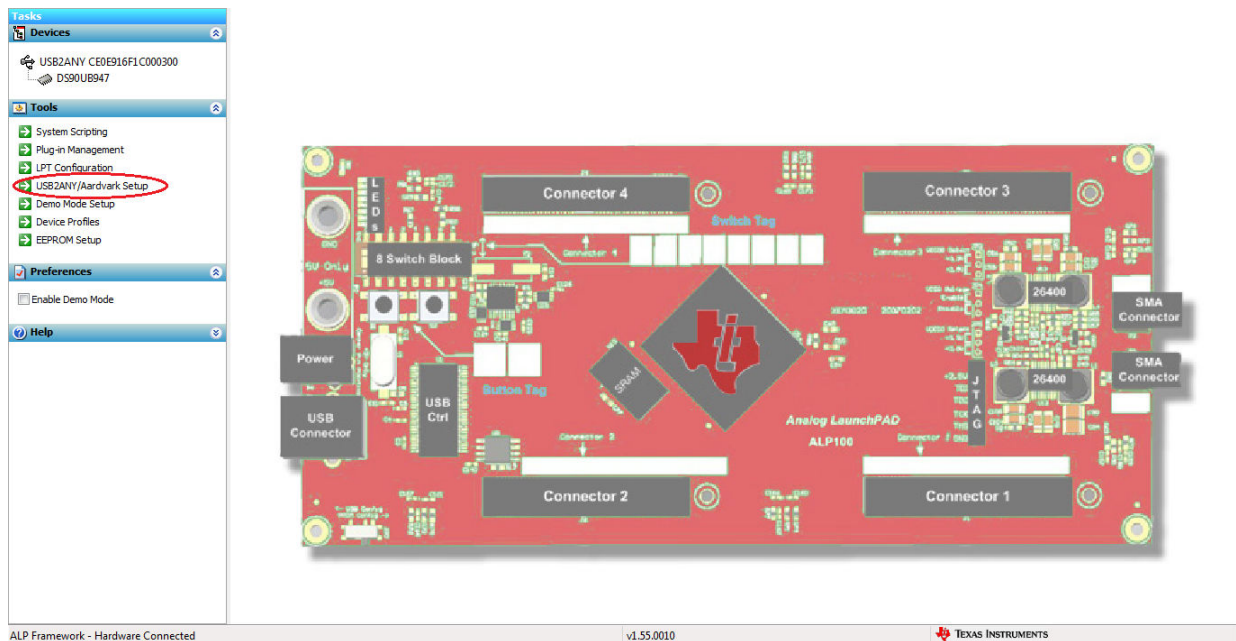


Figure 3-16. USB2ANY Setup

Highlight the incorrect profile in the Defined ALP Devices list and press the remove button.

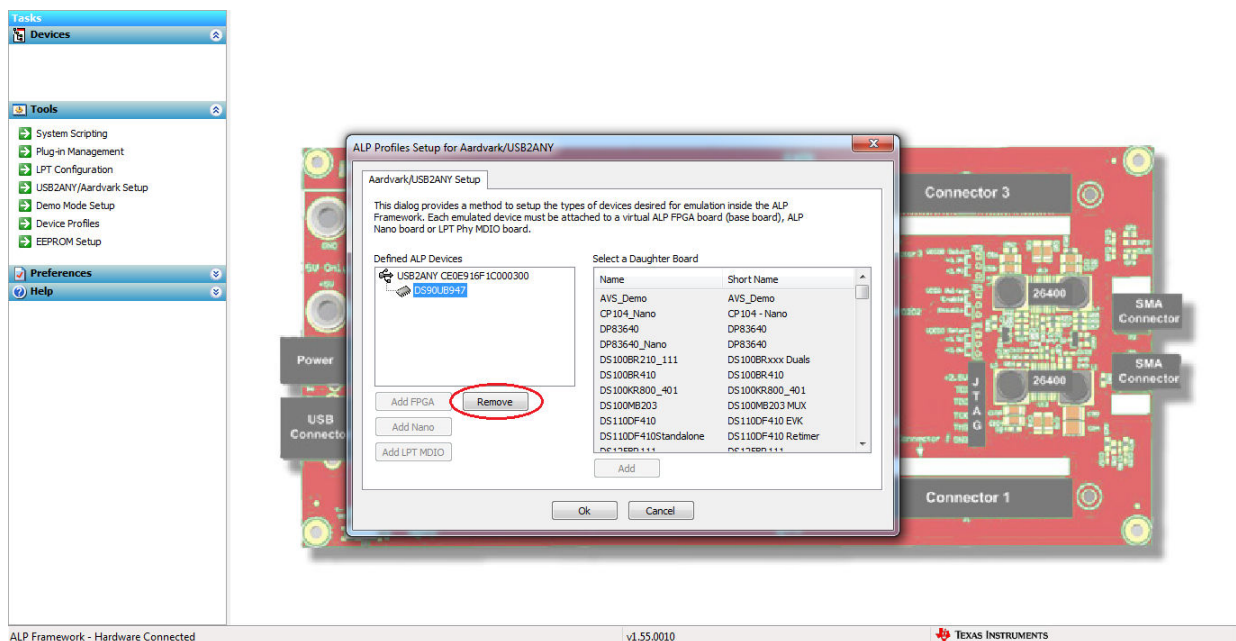
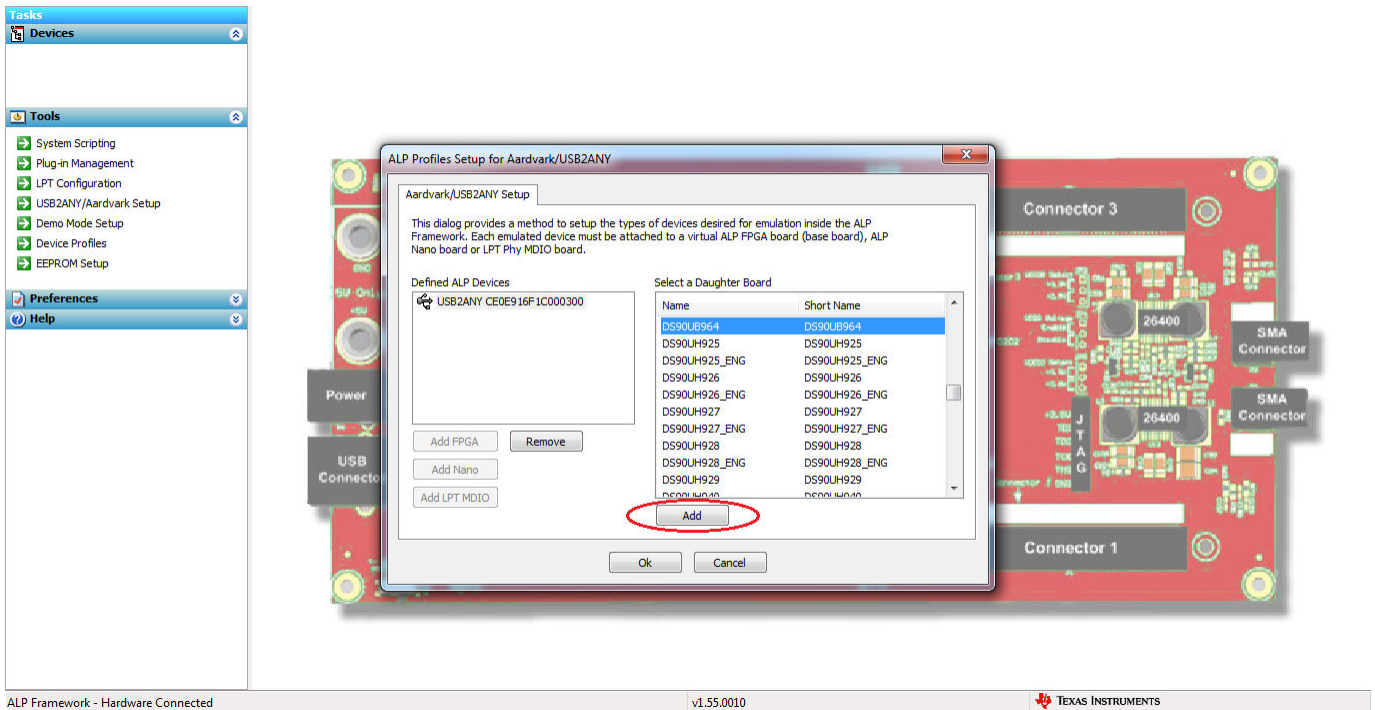


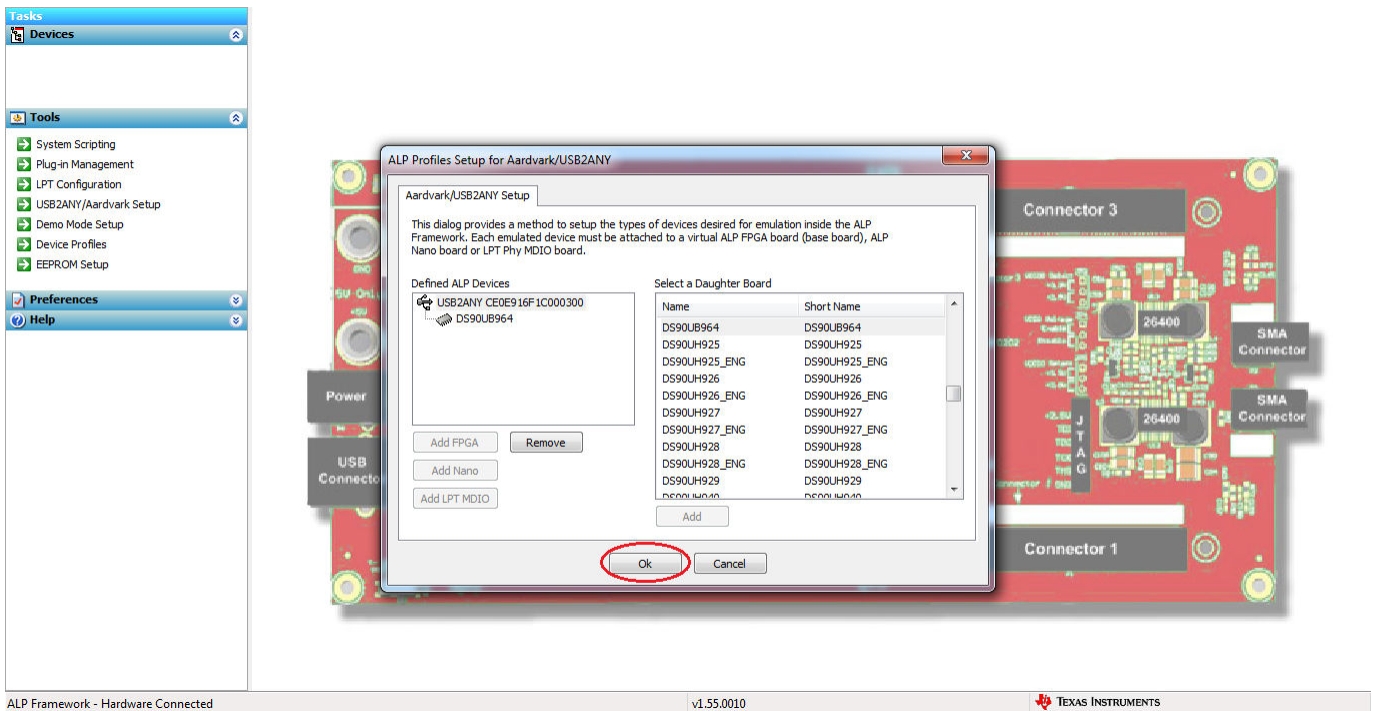
Figure 3-17. Remove Incorrect Profile

Find the correct profile under the Select a Daughter Board list, highlight the profile and press Add.



**Figure 3-18. Add Correct Profile**

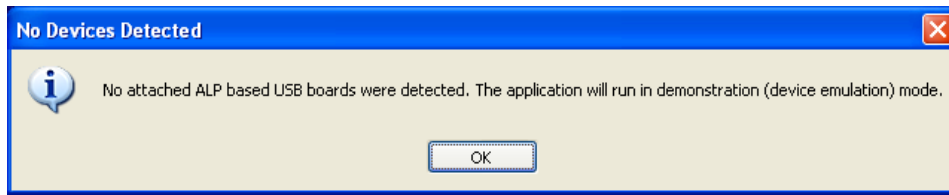
Select Ok and the correct profile should now be loaded.



**Figure 3-19. Finish Setup**

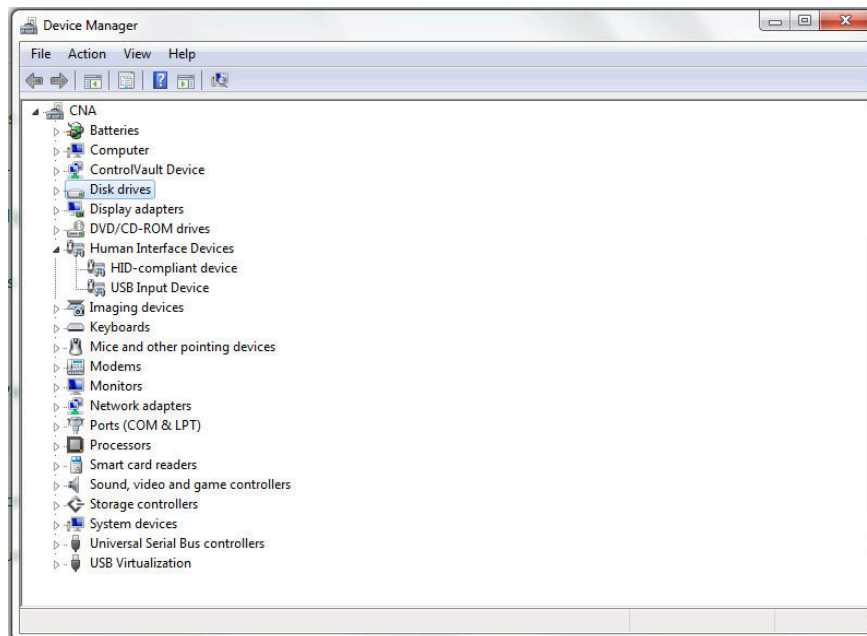
### 3.4.2 ALP Does Not Detect the EVM

If the following window opens after starting the ALP software, double check the hardware setup.



**Figure 3-20. ALP No Devices Error**

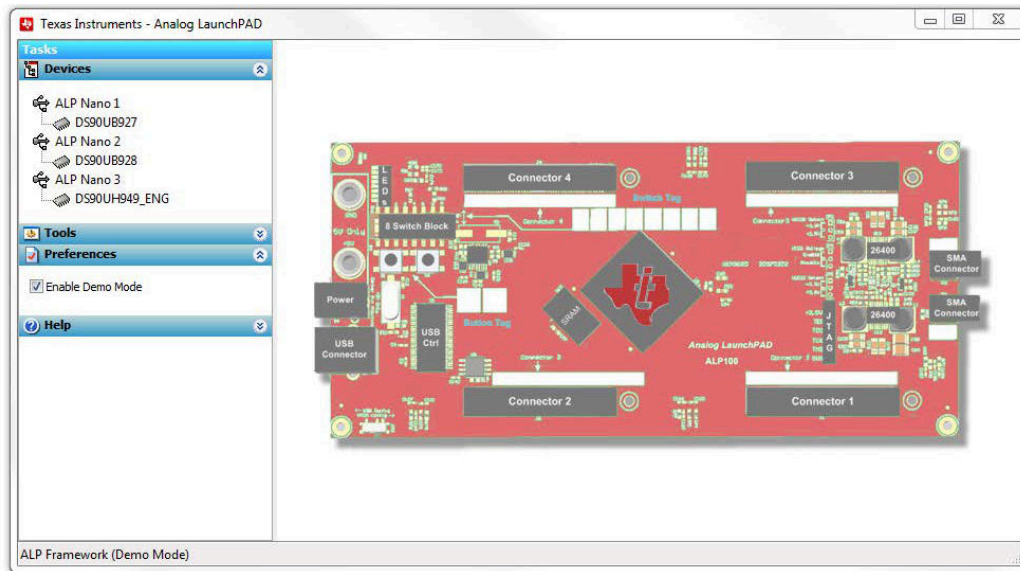
It may also be that the USB2ANY driver is not installed. Check the device manager. There should be a *HID-compliant device* under the *Human Interface Devices* as shown below.



**Figure 3-21. Windows 7, ALP USB2ANY Driver**

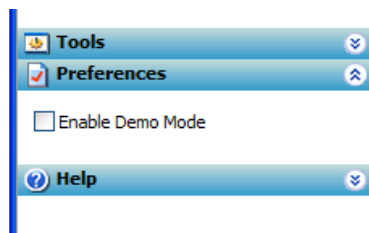


The software should start with only *DS90UB95x* in the *Devices* drop-down menu. If there are more devices then the software is most likely in demo mode. When the ALP is operating in demo mode there is a (*Demo Mode*) indication in the lower left of the application status bar as shown below.



**Figure 3-22. ALP in Demo Mode**

Disable the demo mode by selecting the *Preferences* drop-down menu and unchecking *Enable Demo Mode*.

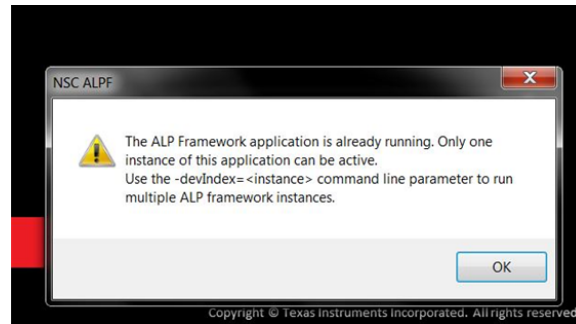


**Figure 3-23. ALP Preferences Menu**

After demo mode is disabled, the ALP software will poll the ALP hardware. The ALP software will update and have only *DS90UB95x* under the *Devices* drop-down menu.

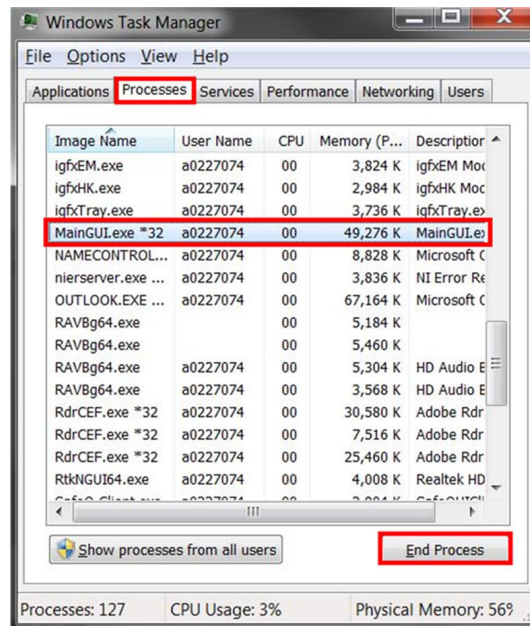
### 3.4.3 Error When Opening ALP: One Instance of this Application Can Be Active

Figure 3-24 shows the error message that states *only one instance of this application can be active*. This occurs when ALP fails to shutdown correctly.



**Figure 3-24. Error that States One Instance of This Application Can Be Active in ALP**

To fix the error, click **OK** to continue. Access your task manager by pressing CTRL + Shift + ESC or CTRL + ALT + DELETE and selecting task manager. Then, go to the processes tab, select the MainGUI.exe \*32 process, click end process shown in Figure 3-25.

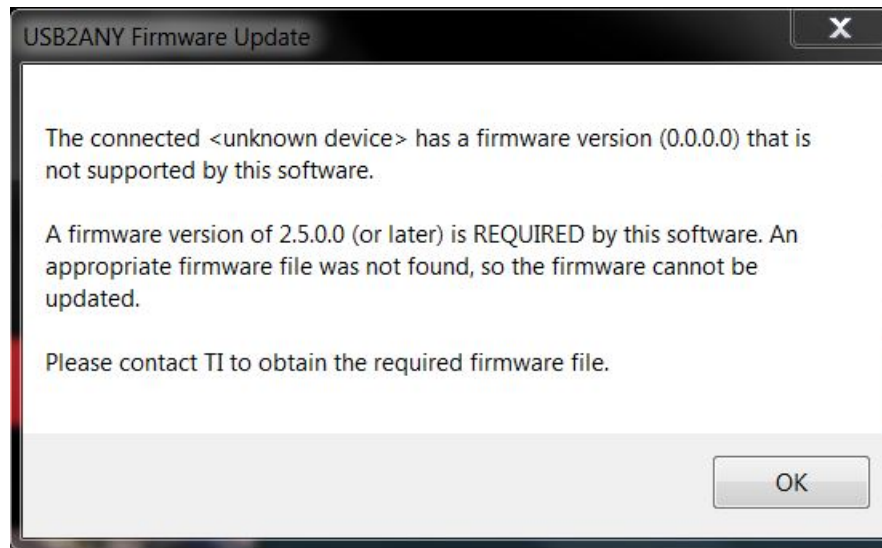


**Figure 3-25. Ending MainGUI.exe in Task Manager**

You should now be able to open ALP normally. If the problem persists, restart your machine and follow the steps again.

### 3.4.4 Error Referring to USB2ANY Firmware Update

Figure 3-26 shows the error message that states that the connected USB2ANY does not have the correct firmware. To update the firmware, follow the steps below:



**Figure 3-26. Error That States That USB2ANY Firmware Must be Updated**

---

#### Note

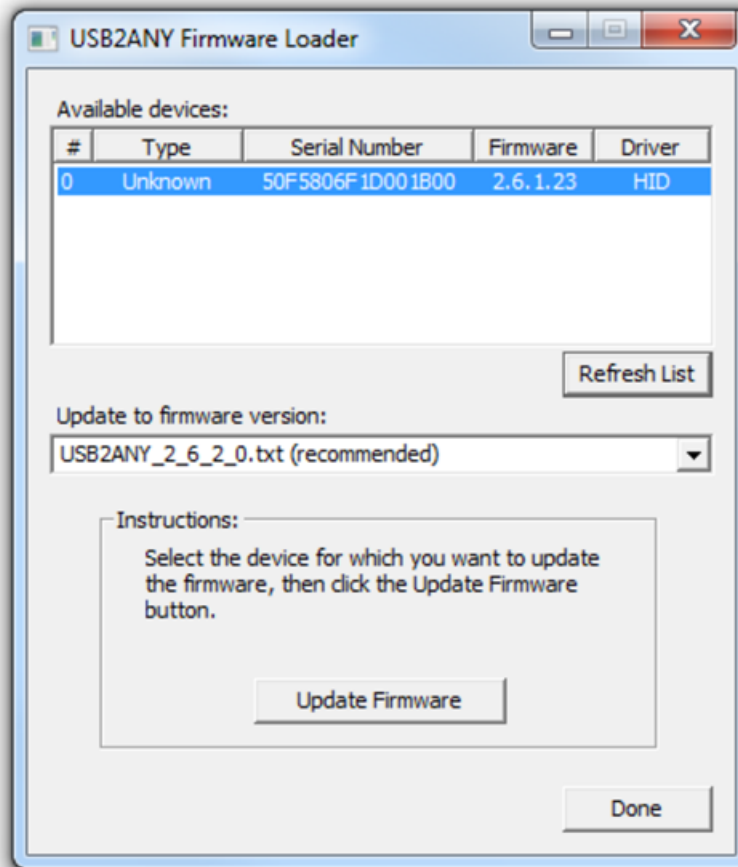
Newer versions of the USB2ANY API Library (USB2ANY.DLL) automatically check the firmware version running on the USB2ANY and update it to the required version automatically, when necessary. That is the preferred method.

In most cases, the USB2ANY Firmware Loader program is no longer required or recommended. It is provided only for legacy applications.

---

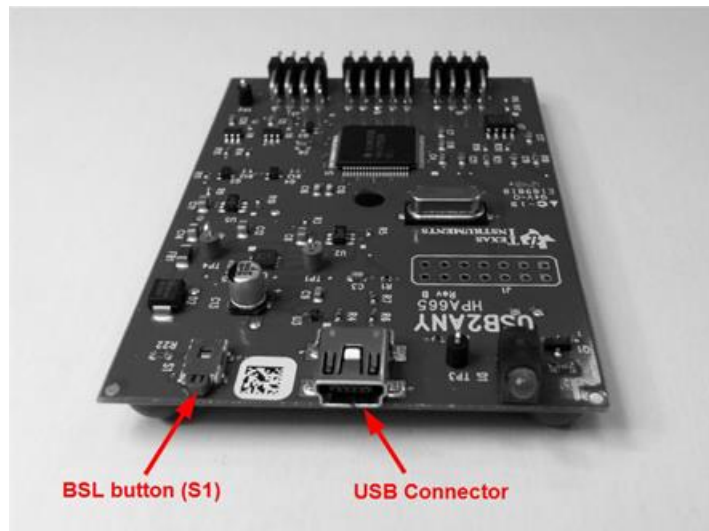
1. Run the *USB2ANY Firmware Loader* program. The installation program will normally create an icon for it on your desktop. By default, the program will be located in the bin folder of the TI USB2ANY SDK folder (for example, *C:\Program Files (x86)\TI USB2ANY SDK\bin*).

The program dialog will look like this:



**Figure 3-27. USB2ANY Firmware Loader Program Dialog**

- Near the top of the dialog, you should see a list of available devices (there is usually only one device), with the first device highlighted.
- If more than one device is displayed, select the desired device using the mouse or arrow keys. If you connect, re-connect, or change devices while the program is running, click the *Refresh List* button to update the displayed list.
- By default, the program will show the recommended firmware version in the *Update to firmware version* drop-down list box. If you want to load an older version of firmware, click the down-arrow button to the right of the list box to display a list of other available versions.
- Click the *Update Firmware* button.
- A confirmation dialog box will display the firmware version selected for the update and prompt to verify that you want to proceed. Click the *Yes* button to continue.
- A new dialog will appear. If the first line of text says *The USB2ANY is ready for download*, proceed to step 9 (that is, skip step 8).
- The dialog will display instructions for preparing the USB2ANY for the firmware download. Follow the instructions, referring to [Figure 3-28](#) and [Figure 3-29](#) for locations of the BSL button (S1 switch) and USB connector. If the USB2ANY is in an enclosure, you will need to insert an implement (a paper clip works great) into the small hole to press the button.



**Figure 3-28. USB2ANY Without Enclosure**



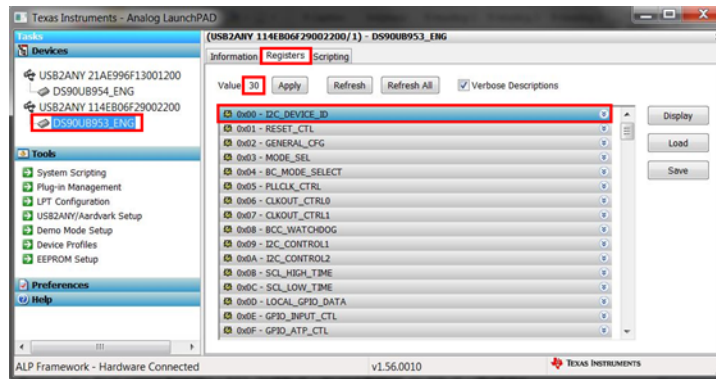
**Figure 3-29. USB2ANY With Enclosure**

9. When the *Update Firmware* button appears, the USB2ANY is ready to be updated with the new firmware. Click the *Update Firmware* button to start the update process.
10. The message *Done!* will appear in the status area when the update completes successfully.
11. Click the *Close* button to return to the previous dialog. If you want to update the firmware on another USB2ANY, go back to Step 2.
12. When finished updating firmware, click the *Done* button.

### 3.4.5 Identifying USB IDs and Corresponding Devices

If you connected both devices to the same machine and are having trouble identifying which device belongs to which USB port, close the USB2ANY/Aardvark Setup, and unplug one of the USB cables from the computer. ALP should automatically update which USB port is still in use. Take note of the remaining USB ID and note whether the 954EVM or 953EVM is connected to the port. Reconnect the other USB cable and assign the appropriate profile to each ID.

Alternatively, arbitrarily assign profiles to each of the USB IDs and open the device page that is assigned to the 953 by double clicking the name. Select the registers tab, click register 0x00 label I2C\_DEVICE\_ID, and read the value, shown in [Figure 3-30](#).



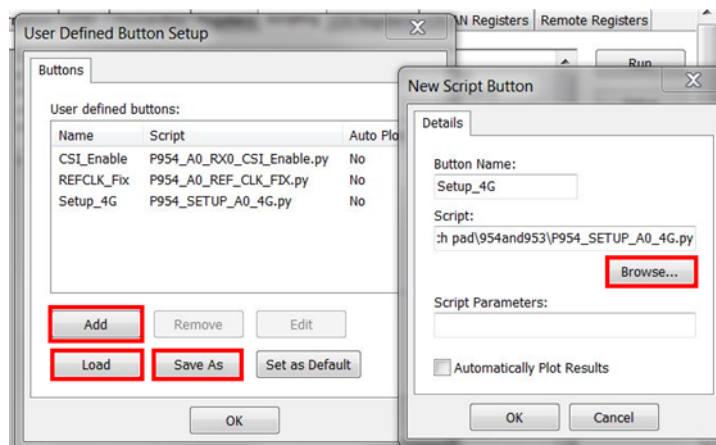
**Figure 3-30. Verifying DS90UB95x Register**

The default I2C Device ID for the 953 is 0x30. If the value is 0x00 instead of 0x30, you need to switch the profiles for the assigned USB ID and re-verify the Device ID.

### 3.4.6 Set up File for Loading Scripts and Create Buttons for Each Script

ALP has a feature that allows the user to load multiple scripts by using one file and create buttons that run the scripts when clicked. To configure this file, go the scripting tab in DS90UB954 (or variant) device page. After navigating to the scripting tab, click Setup.

After clicking Add in the new window, ALP will bring up another separate window with Button Name and Script fields. Using the Browse button, navigate to the script you would like to add and double click the file. In the Button Name field, write in a name the script—note that this name will show up on the button that is created. For example, in [Figure 3-31](#), the script P954\_SETUP\_A0\_4G is named Setup\_4G.



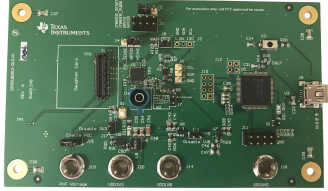
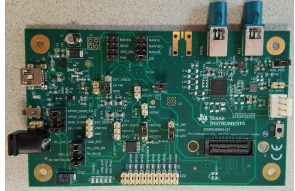





**Figure 3-31. Window for Setting up Scripts in ALP**

After adding every script with an appropriate name, click save as and save the setup file in an appropriate location. Whenever you open the program again, you can open this file and every script will be added to the setup window. When done saving and adding scripts, press OK. The buttons should be added to the right-hand side of the window under the Setup and Run buttons in the script tab.

### 3.5 Additional Troubleshooting – Step-by-Step Guide

#### 3.5.1 EVM Equipment

**Table 3-1. Equipment**

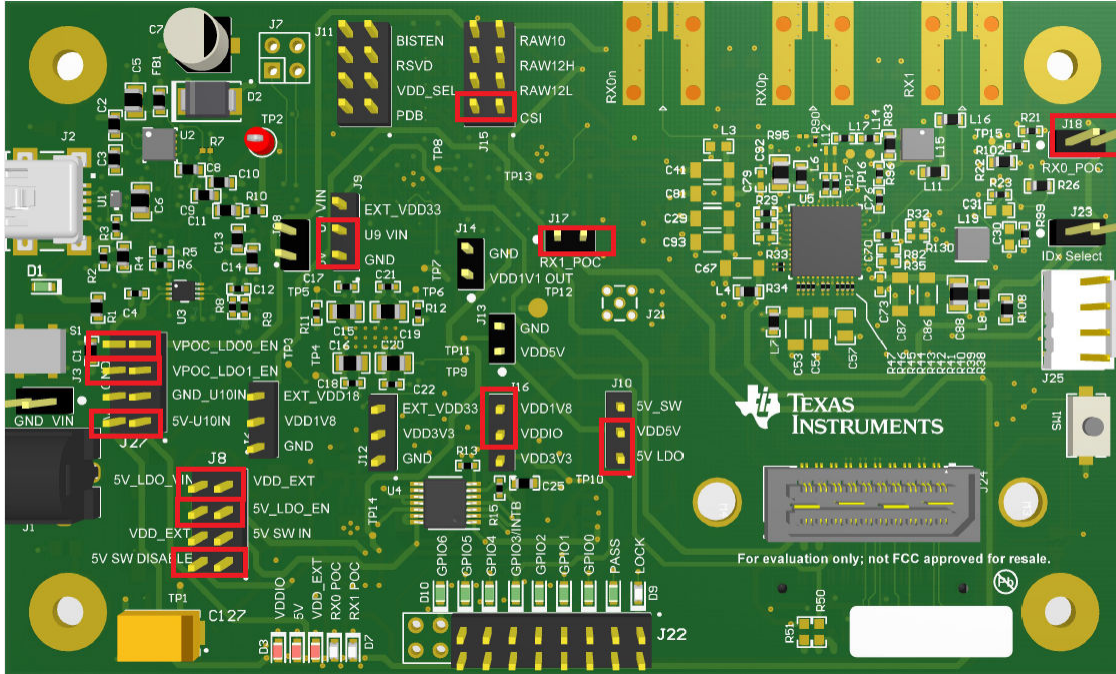
EQUIPMENT	SPECIFICATIONS	RECOMMENDED MODEL	PICTURE
DS90UB95x-Q1EVM		REV A1	
DS90UB954-Q1EVM (or variant)		REV A1	
DC Power Supply		HP E3610A (or any DC Power Supply capable of delivering 12 V)	
DACAR/FAKRA coax cable	1 – Male DACAR/ FAKRA coax to DACAR/ FAKRA coax cable		
USB2ANY (optional)	3 – Jumper Wires: 1 blue, 1 green, and 1 yellow (colors do not matter)	USB2ANY	
USB to Mini USB Cables	2 – Male USB to Mini USB cables		
Banana to Coaxial cable	1 – Male, red and black banana to male coax	(Alternatively, use two male banana to grabber wires, more information in step 5 of <a href="#">Section 2.4</a> ).	

### 3.5.2 EVM Equipment Setup

1. Power ON the HP E3610A.
2. Verify that CC SET is not on which is indicated by the illuminated light next to CV.
3. Verify that RANGE is in 2-A mode which is indicated by the depressed RANGE button
4. Use the Voltage knob to adjust the voltage to 12 V.
5. Power OFF the HP E3610A
6. Connect the red and black banana to coax cable from the + and – output of the HP E3610A, respectively, to the coax jack, J24, on the DS90UB954EVM (or variant) labeled 12 V. Alternatively, use the red and black banana to grabber cables from the “+” and “-“ output of the supply to pin 1 and 2, respectively, of J20, on the DS90UB954EVM (or variant) labeled GND and VDD\_EXT near the lower left side of the board.
7. Connect the FPD Link III cable from CN1 on the DS90UB954EVM (or variant) to J11 on the DS90UB953EVM. Ensure there is a click when connecting the cable to the connectors.
8. Connect the Mini USB to USB cable from J5 on the DS90UB954EVM (or variant) to the computer that will use Analog Launch Pad (ALP).
9. Connect the Mini USB to USB cable from J9 on the DS90UB953EVM to the computer that will use Analog Launch Pad (ALP).

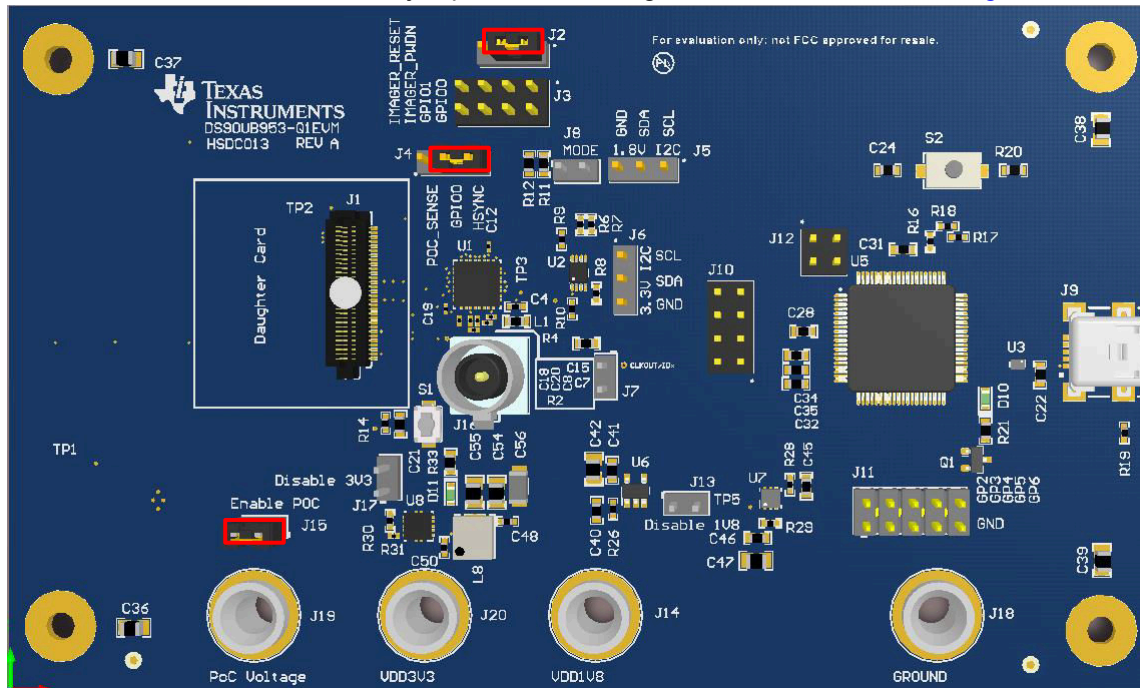


- On the DS90UB954EVM (or variant), ensure that all jumpers are correctly covering the headers highlighted in Figure 3-32.



**Figure 3-32. DS90UB954-Q1EVM (or variant) With Highlighted Jumpers**

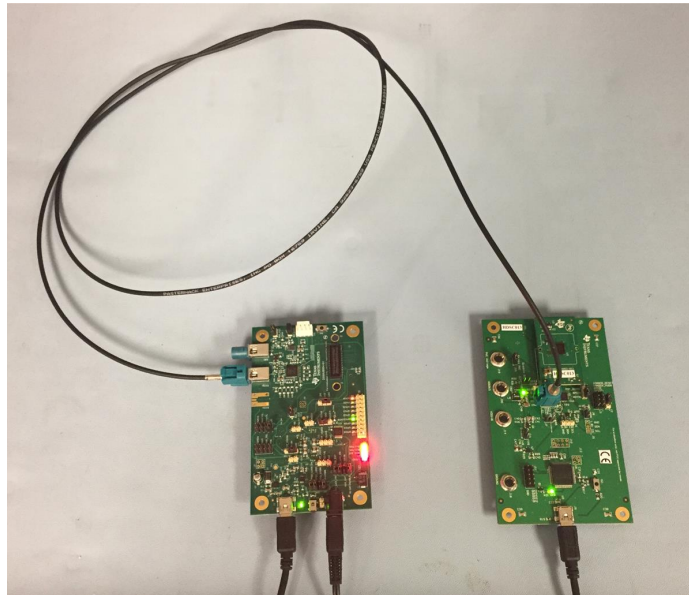
- On the DS90UB953EVM, ensure that jumpers are covering the headers as shown in [Figure 3-33](#).



**Figure 3-33. DS90UB95x-Q1EVM With Installed Jumpers**

- Power ON the HP E3610A.
- Verify that DS90UB953EVM is correctly powered by probing the banana jacks labeled PoC Voltage, VDD3V3, and VDD1V8 using a Digital Multi-meter (DMM). The voltages should approximately read  $\geq 7$  V, 3.3 V, and 1.8 V, respectively.

14. The setup should now look like what is shown in the [Figure 3-34](#).



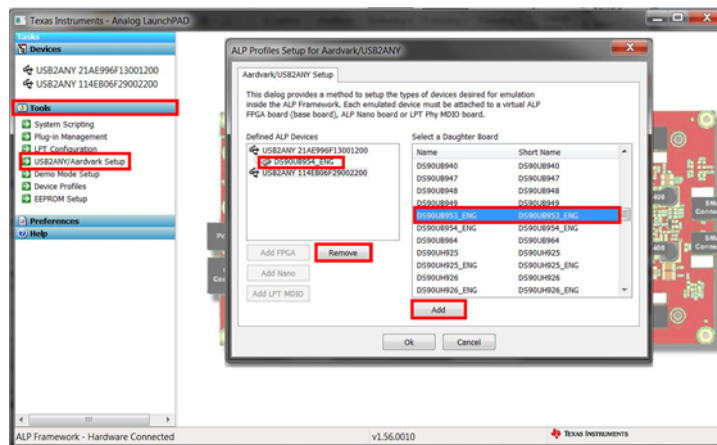
**Figure 3-34. Test Setup**

15. Ensure Analog Launch PAD (ALP) software is downloaded and installed correctly. One can download [Analog Launch PAD](#) from TI.com; note this requires a myTI Login. Steps for installation can be found in [Section 3.3](#)
  16. Open the ALP software. If you receive an error message about running the device in demonstration mode consult [Section 3.4.2](#). If you receive an error message about MainGUI.exe or having one instance of the application open at once, consult [Section 3.4.3](#).
- If you receive an error message about updating the USB2ANY firmware, consult [Section 3.4.4](#).
17. Double click the Tools bar, then the USB2ANY/Aardvark Setup, remove any devices that are not the 954 or 953 profiles by selecting them and clicking remove.

**Note**

Be sure **NOT** to remove the USB ID or you will have to consult [Section 3.4.2](#).

Then select the appropriate device profile for the appropriate USB port using the scrolling menu on the right and clicking add as shown in [Figure 3-35](#).

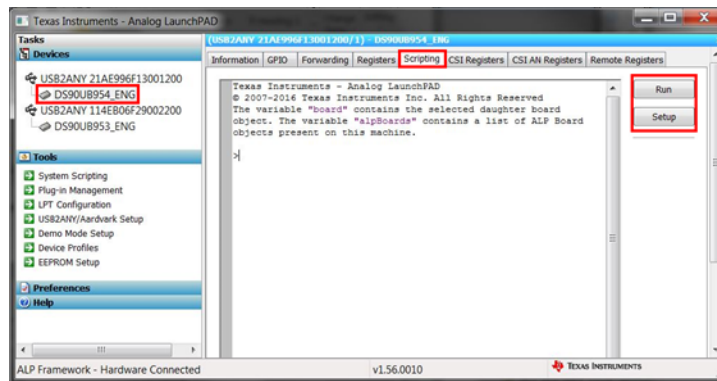


**Figure 3-35. Setting up Device Profiles in ALP**

18. If you are having trouble identifying which USB ID corresponds to a connected device, consult [Section 3.4.5](#).

**3.5.3 Procedure**

1. Open the DS90UB954 (or variant) device window by double clicking the profile and selecting to the scripting tab as shown in [Figure 3-36](#).



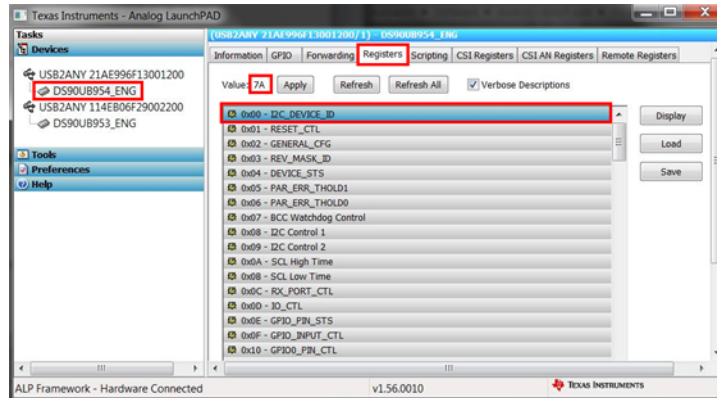
**Figure 3-36. Navigating to DS90UB954 (or variant) Scripting Tab in ALP**

2. If you would like to set up a file that loads all of the scripts and creates a button for running each script, consult [Section 3.4.6](#). Otherwise, you can run scripts by clicking the Run button and navigating to their file location.

- If you would like to place the scripts in the default ALP script folder, move them to the file location:

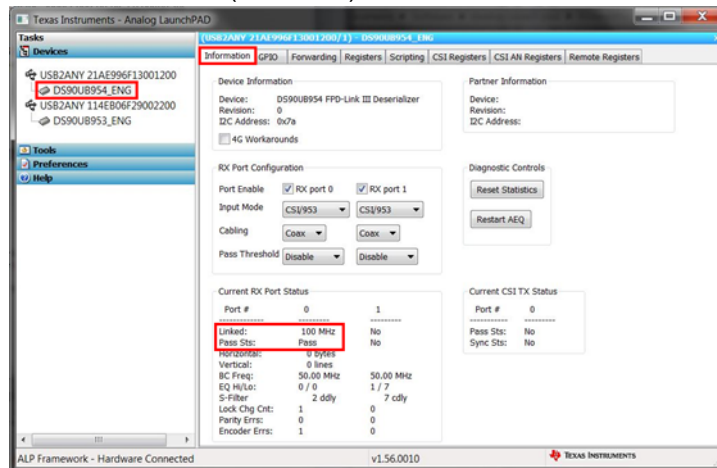
*C:\Program Files (x86)\Texas Instruments\Analog LaunchPAD 1.56.0010*

- Verify there is successful local I2C communication that the script worked by going to the register tab, selecting register 0x00 labeled I2C\_DEVICE\_ID, and reading the value as shown in Figure 3-37. If the value is not 0x7A, then the correct profile has not been assigned to the correct USB2ANY ID. Consult Section 3.4.5 for more information.



**Figure 3-37. Reading I2C Device ID Within the Register Tab**

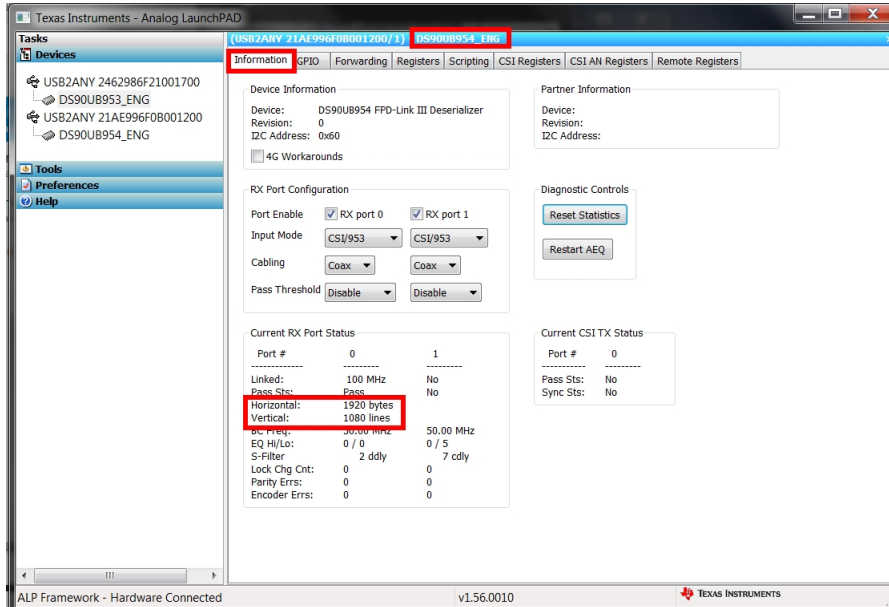
- Ensure that the devices are setup properly by checking that Pass Sts: displays Pass and Linked has a frequency listed like shown in Figure 3-38. In addition, be sure that D3, labeled Lock, and D15 label Pass, are illuminated on the DS90UB954EVM (or variant).



**Figure 3-38. Verifying Pass and Lock for DS90UB954 (or variant) in ALP**

- Navigate back to the Scripting tab of the DS90UB954 (or variant) ALP profile and run the 953to954\_patgen\_YUV\_1920x1080p-4Lanes-Working.py script to initialize a pattern generation from 953->954. The script may be found by clicking on the "Run PreDef Script" button. If the DS90UB954-Q1 (or variant) is not using an I2C address of 0x7A (8-bit form), the script should be modified to use the correct I2C address.

- Verify that the pattern has been enabled navigating to the information tab on the DS90UB954 (or variant), and checking to the horizontal and vertical parameters for the appropriate resolution defined by the camera. [Figure 3-39](#) shows 3840 bytes and 1080 lines for the horizontal and vertical parameters, respectively. Also, verify that the DC power supply, the HP E3610, is sourcing more current.



**Figure 3-39. Verifying Camera Initialization in ALP**

## 4 Bill of Materials

Table 4-1. Bill of Materials

DESIGNATOR	QTY.	VALUE	DESCRIPTION	PACKAGE REFERENCE	PART NUMBER	MANUFACTURER
!PCB1	1		Printed-Circuit Board		Printed-Circuit Board	Any
C1, C2, C3	3	1uF	CAP, CERM, 1 $\mu$ F, 6.3 V, +/- 20%, X7R, 0402	0402	GRM155R70J105MA12D	MuRata
C4, C5, C6, C9, C48, C64	6	0.01uF	CAP, CERM, 0.01 $\mu$ F, 50 V, +/- 5%, X7R, 0402	0402	C0402C103J5RACTU	Kemet
C7	1	0.033uF	CAP, CERM, 0.033 $\mu$ F, 6.3 V, +/- 10%, X5R, 0201	0201	GRM033R60J333KE01D	MuRata
C8	1	0.015uF	CAP, CERM, 0.015 $\mu$ F, 6.3 V, +/- 10%, X5R, 0201	0201	GRM033R60J153KE01D	MuRata
C10, C13, C16, C54, C55, C62, C63	7	10uF	CAP, CERM, 10 $\mu$ F, 6.3 V, +/- 10%, X7R, 0805	0805_HV	GRM21BR70J106KE76L	MuRata
C11, C14, C17	3	0.1uF	CAP, CERM, 0.1 $\mu$ F, 50 V, +/- 20%, X7R, AEC-Q200 Grade 1, 0402	0402	CGA2B3X7R1H104M050BB	TDK
C12, C15, C18	3	0.01uF	CAP, CERM, 0.01 $\mu$ F, 10 V, +/- 10%, X7R, AEC-Q200 Grade 1, 0201	0201_033	CGA1A2X7R1A103K030BA	TDK
C19	1	0.022uF	CAP, CERM, 0.022 $\mu$ F, 6.3 V, +/- 10%, X5R, 0201	0201	GRM033R60J223KE01D	MuRata
C20	1	0.1uF	CAP, CERM, 0.1 $\mu$ F, 6.3 V, +/- 10%, X5R, 0201	0201	C0603X5R0J104K030BC	TDK
C21, C40, C41, C45, C46, C49, C60	7	1uF	CAP, CERM, 1 $\mu$ F, 16 V, +/- 10%, X7R, 0603	0603	C1608X7R1C105K080AC	TDK
C22, C28, C34, C35	4	0.1uF	CAP, CERM, 0.1 $\mu$ F, 16 V, +/- 5%, X7R, 0603	0603	0603YC104JAT2A	AVX
C23	1	2.2uF	CAP, CERM, 2.2 $\mu$ F, 16 V, +/- 10%, X5R, 0805	0805_HV	0805YD225KAT2A	AVX
C24, C31	2	220pF	CAP, CERM, 220 pF, 50 V, +/- 1%, C0G/NP0, 0603	0603	06035A221FAT2A	AVX
C25	1	0.01uF	CAP, CERM, 0.01 $\mu$ F, 50 V, +/- 10%, X7R, 0603	0603	C1608X7R1H103K080AA	TDK
C26	1	22uF	CAP, TA, 22uF, 25V, +/-20%, 0.7 ohm, SMD	7343-31	293D226X0025D2TE3	Vishay-Sprague
C27	1	1uF	CAP, CERM, 1 $\mu$ F, 50 V, +/- 10%, X7R, AEC-Q200 Grade 1, 0805	0805_HV	CGA4J3X7R1H105K125AB	TDK
C29, C30	2	30pF	CAP, CERM, 30 pF, 100 V, +/- 5%, C0G/NP0, 0603	0603	GRM1885C2A300JA01D	MuRata
C32	1	0.47uF	CAP, CERM, 0.47 $\mu$ F, 10 V, +/- 10%, X7R, 0603	0603	GRM188R71A474KA61D	MuRata
C33	1	2200pF	CAP, CERM, 2200 pF, 50 V, +/- 10%, X7R, 0603	0603	C0603X222K5RACTU	Kemet
C36, C37, C38, C39	4	4700pF	CAP, CERM, 4700 pF, 100 V, +/- 10%, X7R, 0805	0805_HV	08051C472KAT2A	AVX
C42, C47	2	10uF	CAP, CERM, 10 $\mu$ F, 16 V, +/- 10%, X7S, AEC-Q200 Grade 1, 0805	0805_HV	CGA4J1X7S1C106K125AC	TDK
C43, C52, C58	3	4.7uF	CAP, CERM, 4.7 $\mu$ F, 16 V, +/- 10%, X7R, 0805	0805_HV	GRM21BR71C475KA73L	MuRata

**Table 4-1. Bill of Materials (continued)**

DESIGNATOR	QTY.	VALUE	DESCRIPTION	PACKAGE REFERENCE	PART NUMBER	MANUFACTURER
C44, C50, C53, C57, C59	5	0.1uF	CAP, CERM, 0.1 $\mu$ F, 50 V, +/- 10%, X7R, 0402	0402	C1005X7R1H104K050BB	TDK
C51	1	10uF	CAP, CERM, 10 $\mu$ F, 35 V, +/- 10%, X7R, 1206_190	1206_190	GMK316AB7106KL-TR	Taiyo Yuden
C56	1	22uF	CAP, CERM, 22 $\mu$ F, 6.3 V, +/- 10%, X7R, AEC-Q200 Grade 1, 1206	1206_180	CGA5L1X7R0J226M160AC	TDK
C61	1	47pF	CAP, CERM, 47 pF, 50 V, +/- 5%, C0G/NP0, 0402	0402	885012005044	Wurth Elektronik
D9	1	7.5V	Diode, Zener, 7.5 V, 550 mW, SMB	SMB	1SMB5922BT3G	ON Semiconductor
D10, D11	2	Green	LED, Green, SMD	WL-SMCW_GREEN	150060VS75000	Wurth Elektronik eiSos
FB1	1	60 ohm	Ferrite Bead, 60 ohm @ 100 MHz, 0.8 A, 0603	0603	BK1608HS600-T	Taiyo Yuden
FID1, FID2, FID3	3		Fiducial mark. There is nothing to buy or mount.	Fiducial10-20	Fiducial	N/A
J1	1		Receptacle, 0.5mm, 30x2, Gold, SMT	Samtec_SS5-30-3_50-x-D-K	SS5-30-3.50-L-D-K-TR	Samtec
J2, J4	2		Header, 100mil, 3x1, Gold, TH	Samtec_HTSW-103-07-G-S	I2C	Samtec
J3, J10	2		Header, 100mil, 4x2, Gold, TH	TSW-104-07-G-D	TSW-104-07-G-D	Samtec
J5	1		Header, 100mil, 3x1, Gold, TH	Samtec_HTSW-103-07-G-S	1.8V I2C	Samtec
J6	1		Header, 100mil, 3x1, Gold, TH	Samtec_HTSW-103-07-G-S	3.3V I2C	Samtec
J7	1		Header, 100mil, 2x1, Tin, TH	TE_5-146278-2	IDx/CLK_OUT	TE Connectivity
J8	1		Header, 100mil, 2x1, Tin, TH	TE_5-146278-2	MODE	TE Connectivity
J9	1		Connector, Receptacle, Mini-USB Type B, R/A, Top Mount SMT	CONN_USB-Mini-B-1734035-2	USB Mini Type B	TE Connectivity
J11	1		Header, 2.54mm, 5x2, Gold, Black, TH	Samtec_TSW-105-07-x-D	TSW-105-07-F-D	Samtec
J12	1		Header, 100mil, 2x2, Gold, TH	TSW-102-07-G-D	TSW-102-07-G-D	Samtec
J13	1		Header, 100mil, 2x1, Tin, TH	TE_5-146278-2	Disable 1V8	TE Connectivity
J14	1		Standard Banana Jack, Uninsulated, 8.9mm	Keystone575-8	VDD1V8	Keystone
J15	1		Header, 100mil, 2x1, Tin, TH	TE_5-146278-2	Enable PoC	TE Connectivity
J16	1		Connector, HF, 50 Ohm, TH	Rosenberger_59S10H-40ML5-Z	59S10H-40ML5-Z	Rosenberger
J17	1		Header, 100mil, 2x1, Tin, TH	TE_5-146278-2	Disable 3V3	TE Connectivity
J18	1		Standard Banana Jack, Uninsulated, 8.9mm	Keystone575-8	GROUND	Keystone
J19	1		Standard Banana Jack, Uninsulated, 8.9mm	Keystone575-8	PoC Voltage	Keystone
J20	1		Standard Banana Jack, Uninsulated, 8.9mm	Keystone575-8	VDD3V3	Keystone
L1, L2, L3	3	1000 ohm	Ferrite Bead, 1000 ohm @ 100 MHz, 0.4 A, 0603	0603	BLM18AG102SN1D	MuRata
L4	1	47 ohm	Ferrite Bead, 47 ohm @ 100 MHz, 0.45 A, 0402	0402	MPZ1005F470ETD25	TDK
L5	1	330 ohm	Ferrite Bead, 330 ohm @ 100 MHz, 0.7 A, 0402	0402	MPZ1005S331ETD25	TDK
L6, R4, R5	3	0	RES, 0, 5%, 0.1 W, 0603	0603	CRCW06030000Z0EA	Vishay-Dale



**Table 4-1. Bill of Materials (continued)**

DESIGNATOR	QTY.	VALUE	DESCRIPTION	PACKAGE REFERENCE	PART NUMBER	MANUFACTURER
L7	1	10uH	Inductor, Wirewound, Ferrite, 10 µH, 0.5 A, 0.57 ohm, SMD	LQH3NP_G0	LQH3NPN100NG0	MuRata
L8, L9	2	4.7uH	Inductor, Shielded, ?, 4.7uH, 2.3A, 0.092 ohm, SMD	MPI4040R3	MPI4040R3-4R7-R	Coiltronics
Q1	1	50V	MOSFET, N-CH, 50 V, 0.22 A, SOT-23	SOT-23	BSS138	Fairchild Semiconductor
R1	1	0	RES, 0, 5%, 0.05 W, 0201	0201M	ERJ-1GE0R00C	Panasonic
R2	1	49.9	RES, 49.9, 1%, 0.05 W, 0201	0201M	ERJ-1GEF49R9C	Panasonic
R3, R29	2	10.0k	RES, 10.0 k, 0.5%, 0.063 W, 0402	0402	CRCW040210K0DHEDP	Vishay-Dale
R6, R14	2	10.0k	RES, 10.0 k, 1%, 0.063 W, 0402	0402	CRCW040210K0FKED	Vishay-Dale
R7, R8	2	1.21k	RES, 1.21 k, 1%, 0.063 W, 0402	0402	CRCW04021K21FKED	Vishay-Dale
R9, R10	2	4.7k	RES, 4.7 k, 5%, 0.063 W, 0402	0402	CRCW04024K70JNED	Vishay-Dale
R11, R15	2	10.0k	RES, 10.0 k, 1%, 0.1 W, 0603	0603	CRCW060310K0FKEA	Vishay-Dale
R12	1	402	RES, 402, 1%, 0.1 W, 0603	0603	CRCW0603402RFKEA	Vishay-Dale
R13	1	40.2k	RES, 40.2 k, 0.1%, 0.1 W, 0603	0603	RT0603BRD0740K2L	Yageo America
R16, R17	2	33	RES, 33 ohm, 5%, 0.063W, 0402	0402	CRCW040233R0JNED	Vishay-Dale
R18	1	1.5k	RES, 1.5k ohm, 5%, 0.063W, 0402	0402	CRCW04021K50JNED	Vishay-Dale
R19, R23	2	33k	RES, 33k ohm, 5%, 0.063W, 0402	0402	CRCW040233K0JNED	Vishay-Dale
R20	1	1.2Meg	RES, 1.2 M, 5%, 0.1 W, 0603	0603	CRCW06031M20JNEA	Vishay-Dale
R21, R33	2	200	RES, 200, 1%, 0.1 W, 0603	0603	CRCW0603200RFKEA	Vishay-Dale
R22	1	0	RES, 0, 5%, 0.063 W, 0402	0402	ERJ-2GE0R00X	Panasonic
R24, R26, R28, R30	4	10.0k	RES, 10.0 k, 1%, 0.1 W, 0402	0402	ERJ-2RKF1002X	Panasonic
R25	1	4.02k	RES, 4.02 k, 1%, 0.1 W, 0603	0603	CRCW06034K02FKEA	Vishay-Dale
R27	1	1.00k	RES, 1.00 k, 1%, 0.063 W, 0402	0402	CRCW04021K00FKED	Vishay-Dale
R31	1	100k	RES, 100 k, 1%, 0.05 W, 0201	0201M	CRCW0201100KFKED	Vishay-Dale
R32	1	100k	RES, 100 k, 1%, 0.063 W, 0402	0402	CRCW0402100KFKED	Vishay-Dale
R34	1	40.2k	RES, 40.2 k, 1%, 0.063 W, 0402	0402	CRCW040240K2FKED	Vishay-Dale
S1	1		Switch, Tactile, SPST-NO, 0.05A, 12V, SMT	SW_TL1015AF160QG	TL1015AF160QG	E-Switch
S2	1		Switch, Normally open, 2.3N force, 200k operations, SMD	KSR	KSR221GLFS	C and K Components
SH-J1, SH-J2, SH-J3	3	1x2	Shunt, 100mil, Gold plated, Black	SNT-100-BK-G	969102-0000-DA	3M
U1	1		FPD-Link III SerDes with CSI-2 interfaces for 2.3MP/60fps camera, RHB0032P (VQFN-32)	RHB0032P	DS90UB953QRHBQ1	Texas Instruments
U2	1		TCA9406 Dual Bidirectional 1-MHz I2C-BUS and SMBus Voltage Level-Translator, 1.65 to 3.6 V, -40 to 85 degC, 8-pin US8 (DCU), Green (RoHS & no Sb/Br)	DCU0008A_N	TCA9406DCUR	Texas Instruments
U3	1		ESD-Protection Array for High-Speed Data Interfaces, 4 Channels, -40 to +85 degC, 6-pin SON (DRY), Green (RoHS & no Sb/Br)	DRY0006A	TPD4E004DRYR	Texas Instruments

**Table 4-1. Bill of Materials (continued)**

DESIGNATOR	QTY.	VALUE	DESCRIPTION	PACKAGE REFERENCE	PART NUMBER	MANUFACTURER
U4	1		500mA, Low Quiescent Current, Ultra-Low Noise, High PSRR Low-Dropout Linear Regulator, DRB0008A	DRB0008A	TPS73533DRBR	Texas Instruments
U5	1		25 MHz Mixed Signal Microcontroller with 128 KB Flash, 8192 B SRAM and 63 GPIOs, -40 to 85 degC, 80-pin QFP (PN), Green (RoHS & no Sb/Br)	PN0080A_N	MSP430F5529IPN	Texas Instruments
U6	1		ULTRA LOW-NOISE, 250-mA LINEAR REGULATOR FOR RF AND ANALOG CIRCUITS REQUIRES NO BYPASS CAPACITOR, DBV0005A	DBV0005A_N	LP5907MFX-1.8/NOPB	Texas Instruments
U7	1		Ultra Low-Noise, 500-mA Linear Regulator for RF and Analog Circuits - Requires No Bypass Capacitor, DRV0006A (WSON-6)	DRV0006A	LP5912-1.8DRVVR	Texas Instruments
U8	1		Synchronous Buck Regulator for 650mA Space Constraint Applications, DSX0010A	DSX0010A	LM536003QDSXRQ1	Texas Instruments
U9	1		Synchronous Buck Regulator for 650mA Space Constraint Applications, DSX0010A	DSX0010A	LM53600AQDSXRQ1	Texas Instruments
Y1	1		OSC, 50MHz, 1.8 to 3.3V, SMD	Abracon_ASDMB	ASDMB-50.000MHZ-LC-T	Abracon Corporation
Y2	1		Crystal, 24 MHz, 18 pF, SMD	XTAL_ABM3	ABM3-24.000MHZ-D2Y-T	Abracon Corporation

## 5 PCB Schematics

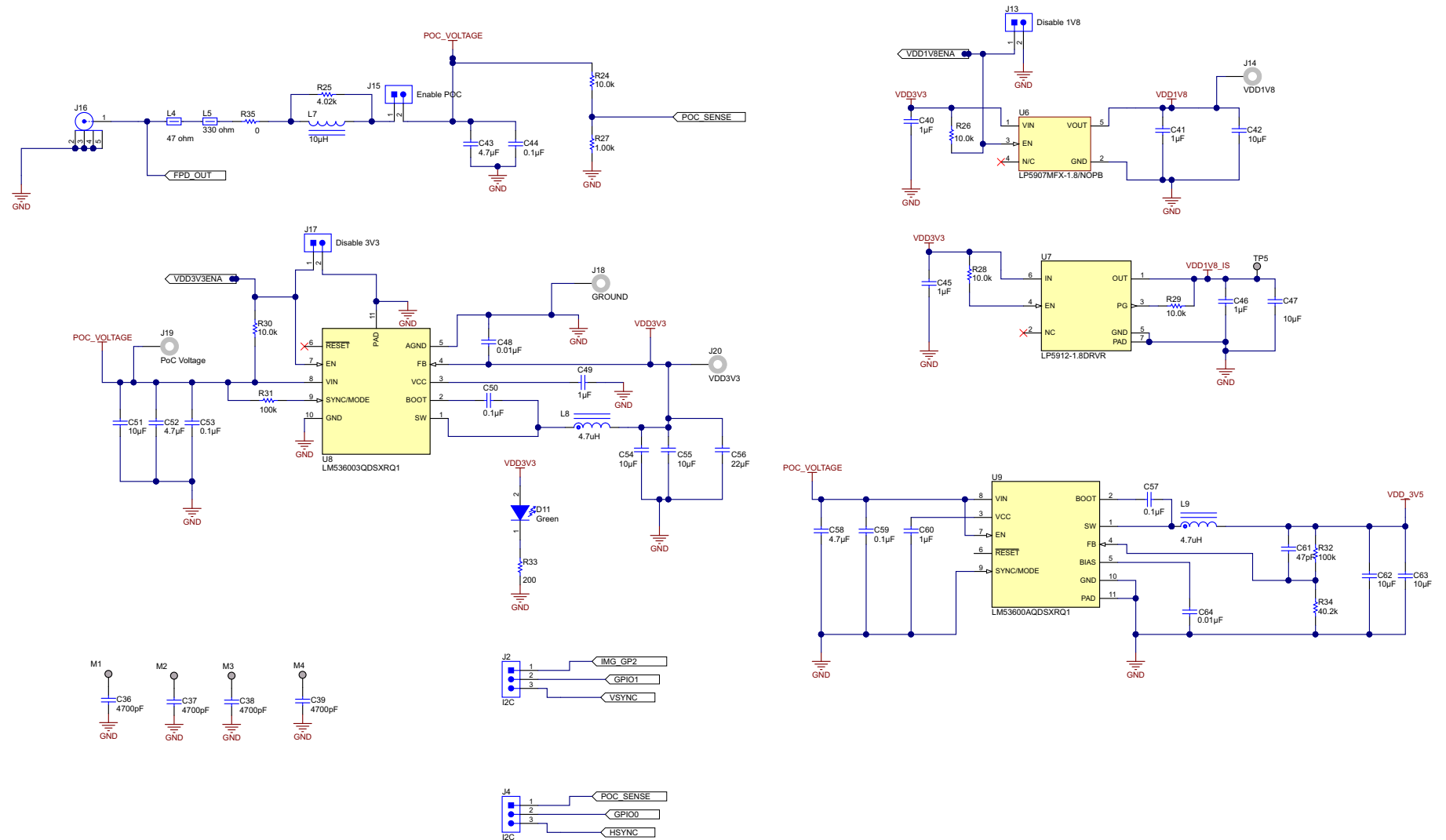


Figure 5-1. DS90UB95x-Q1EVM Schematic 1



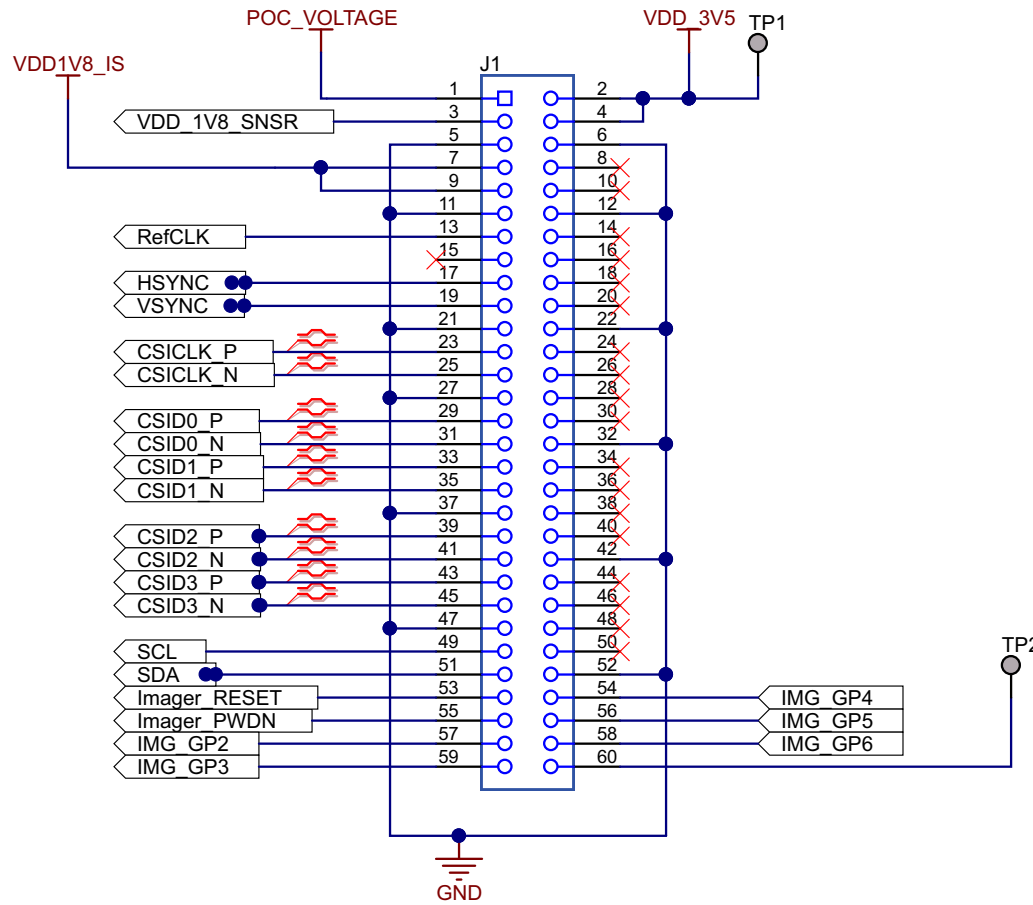


Figure 5-3. DS90UB95x-Q1EVM Schematic 3

Bill of Materials

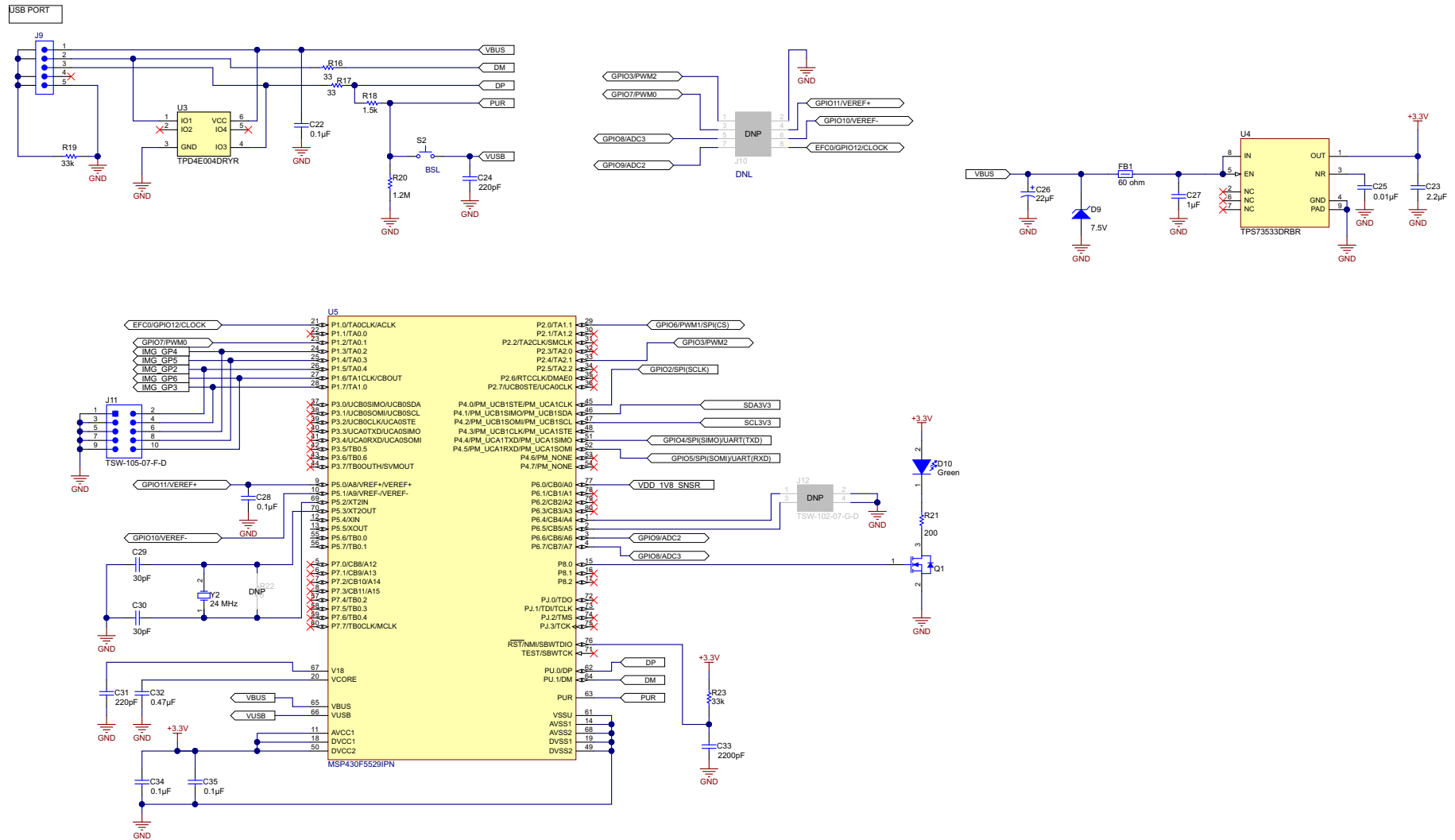
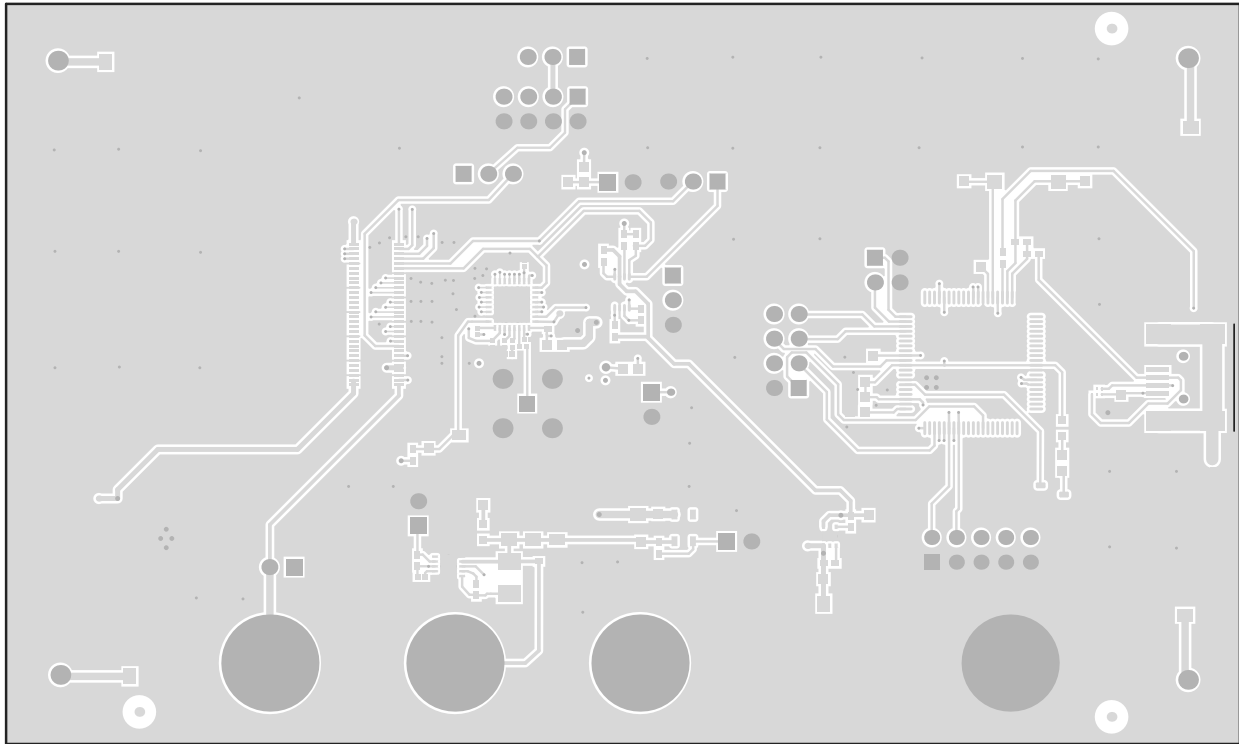


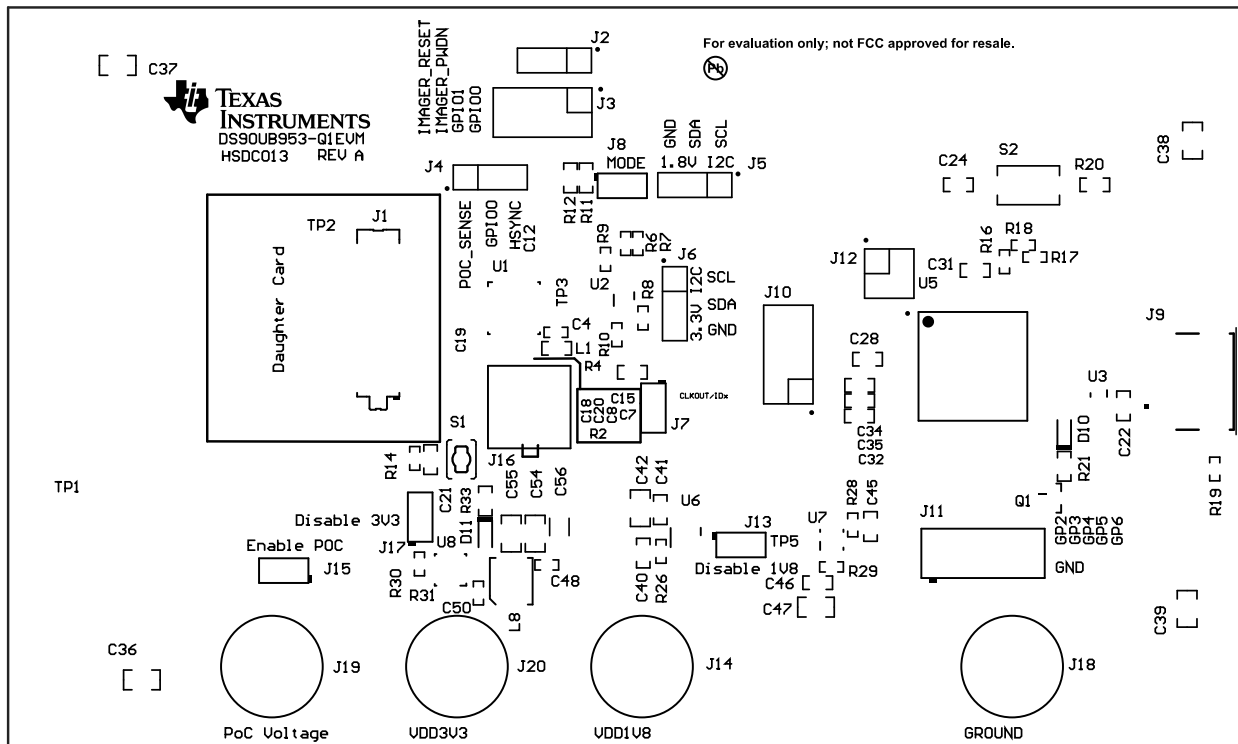
Figure 5-4. DS90UB95x-Q1EVM Schematic 4

## 6 Board Layout

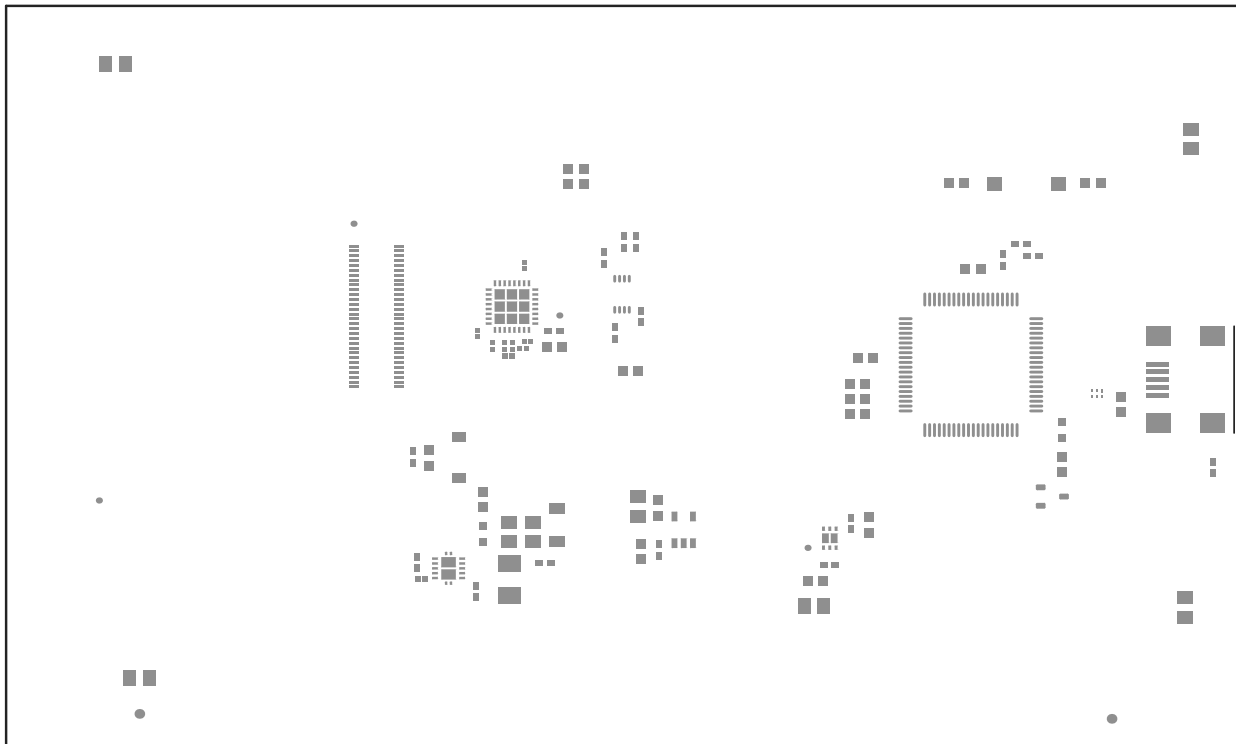
The board layout for the DS90UB95x-Q1EVM is shown in [Figure 6-1](#) through [Figure 6-12](#).



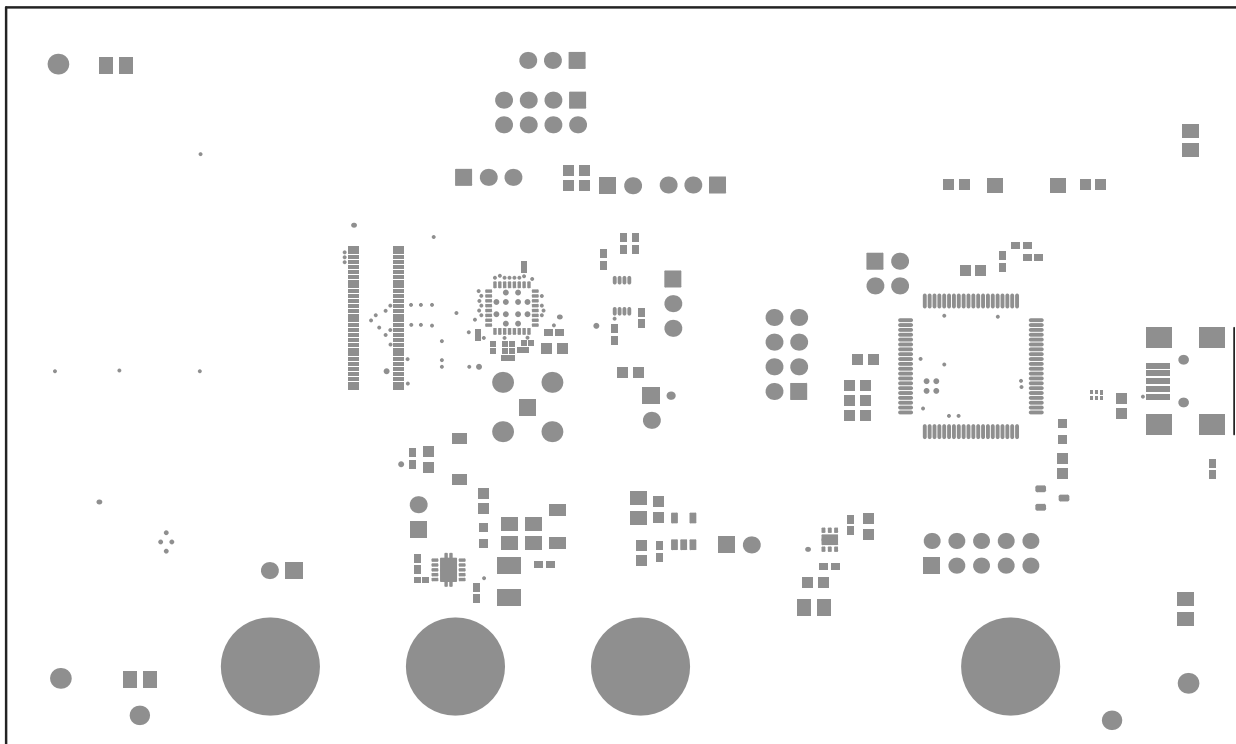
**Figure 6-1. Top Layer PCB Layout**



**Figure 6-2. Top Overlay**

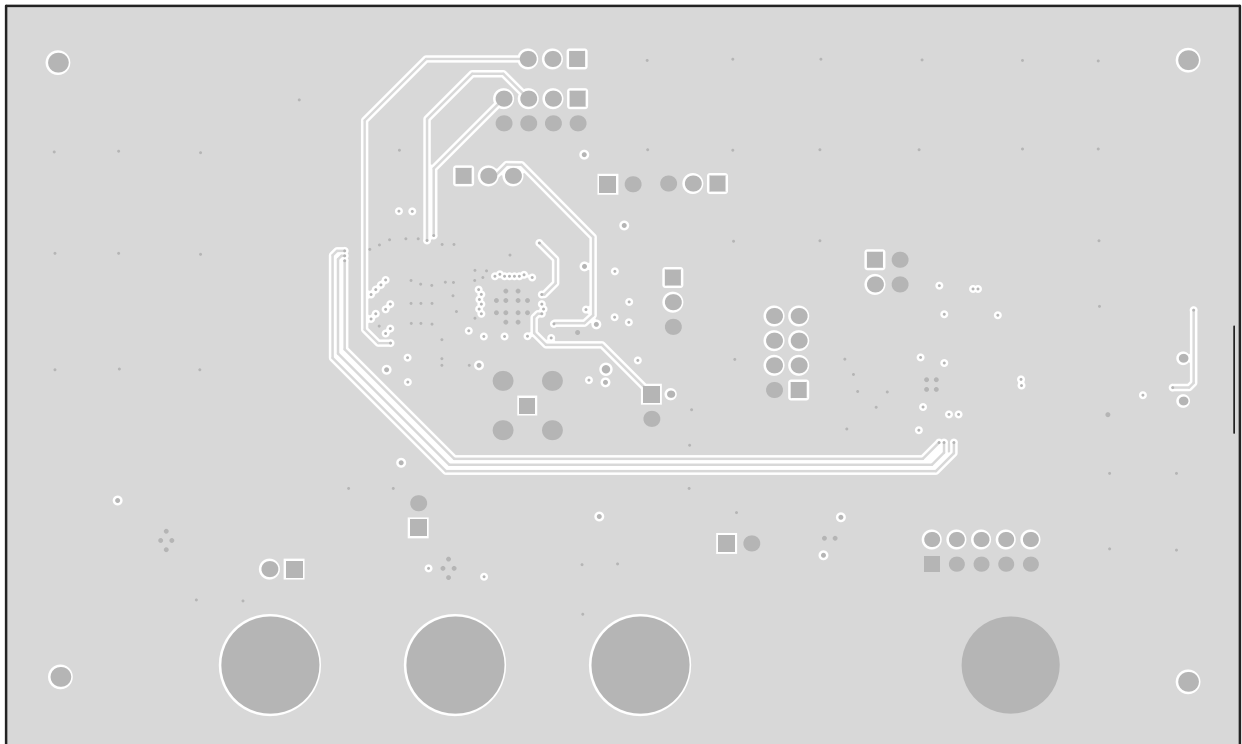


**Figure 6-3. Top Paste**

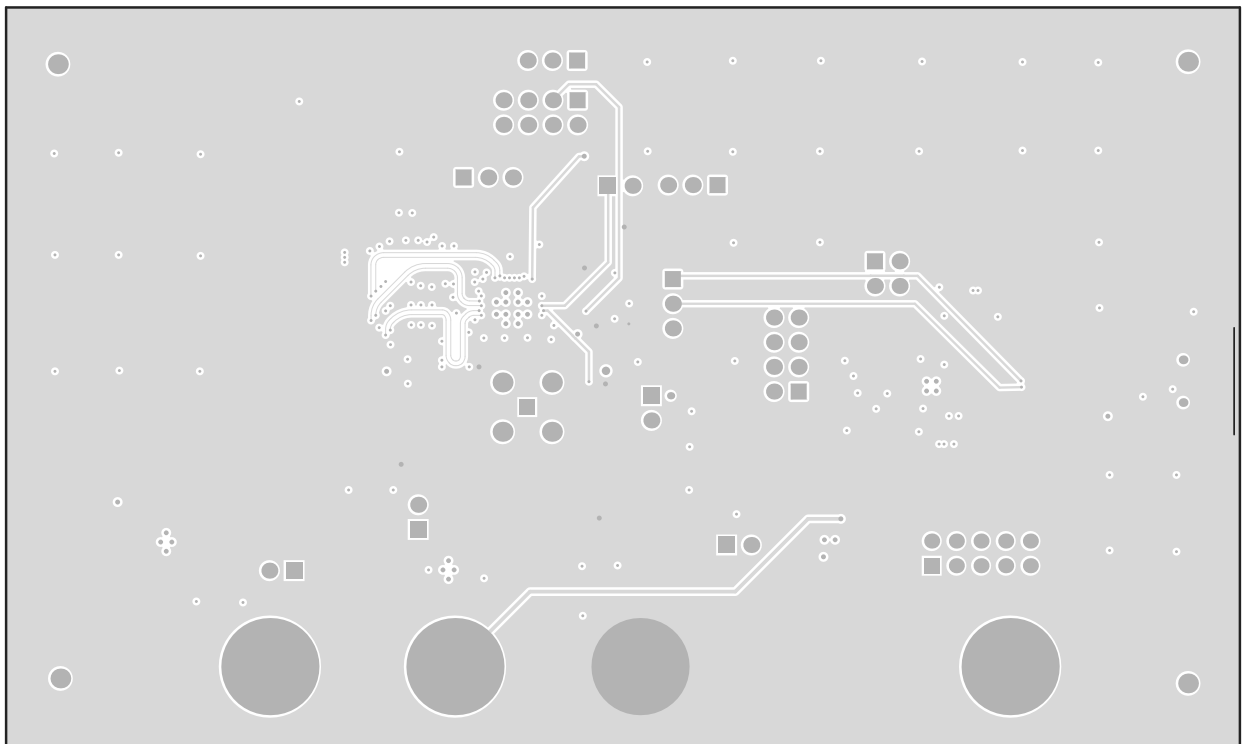


**Figure 6-4. Top Solder**

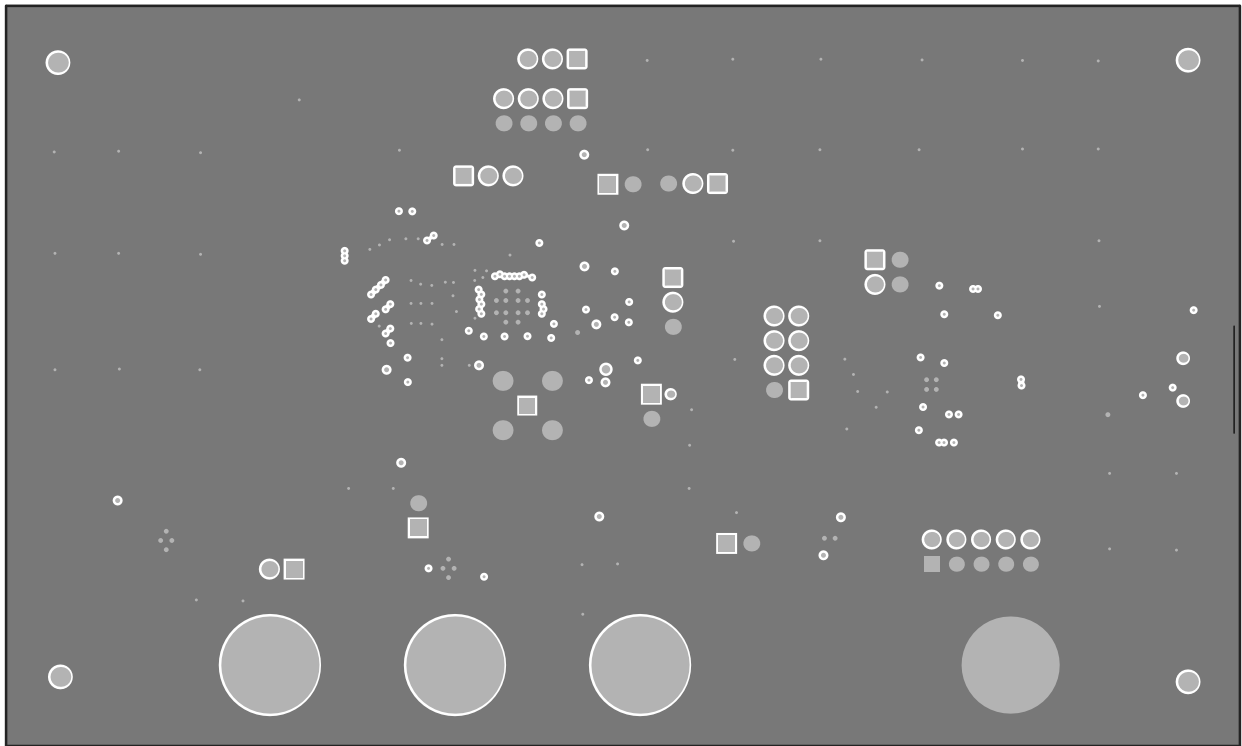




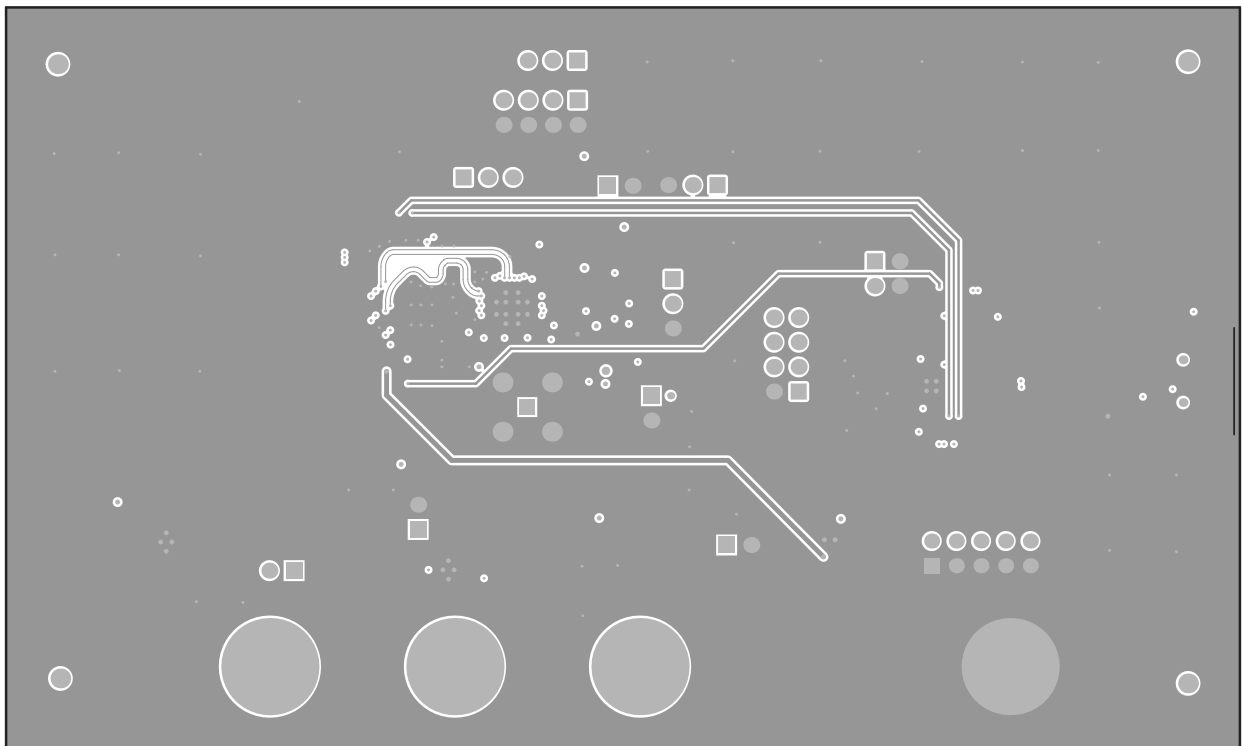
**Figure 6-5. Signal Layer 1**



**Figure 6-6. Signal Layer 2**

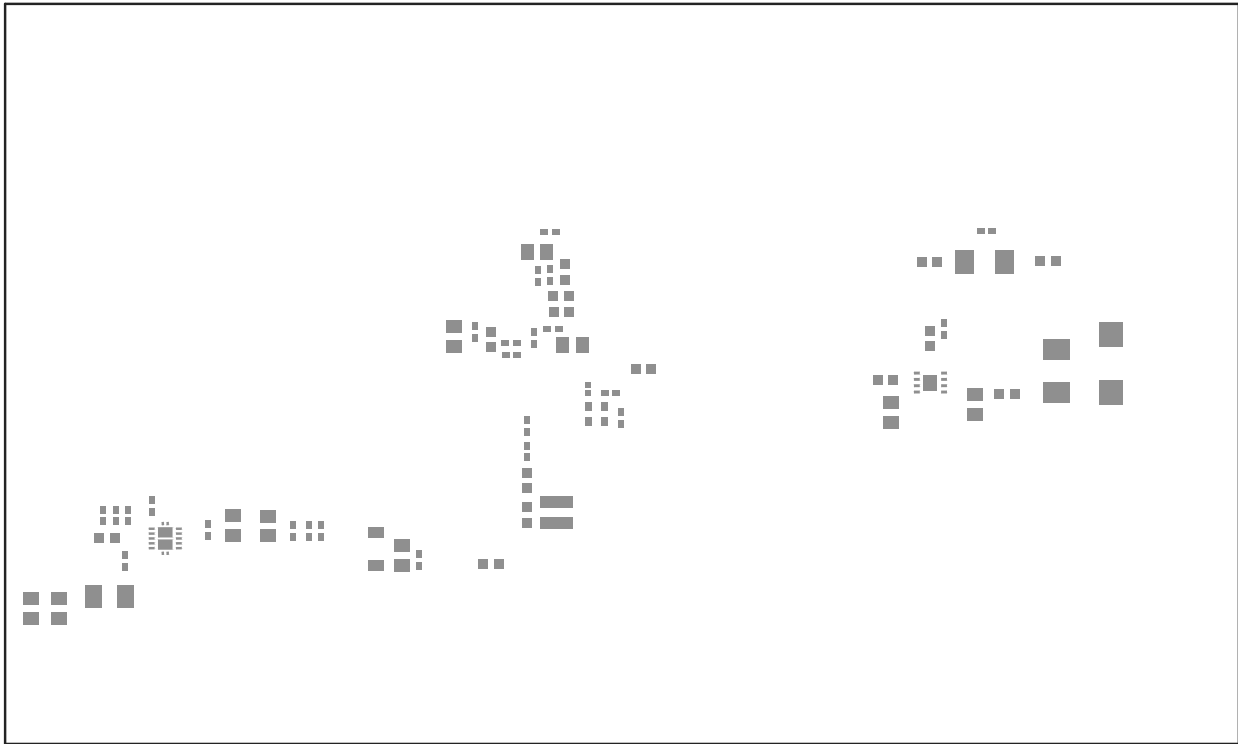


**Figure 6-7. Signal Layer 3**

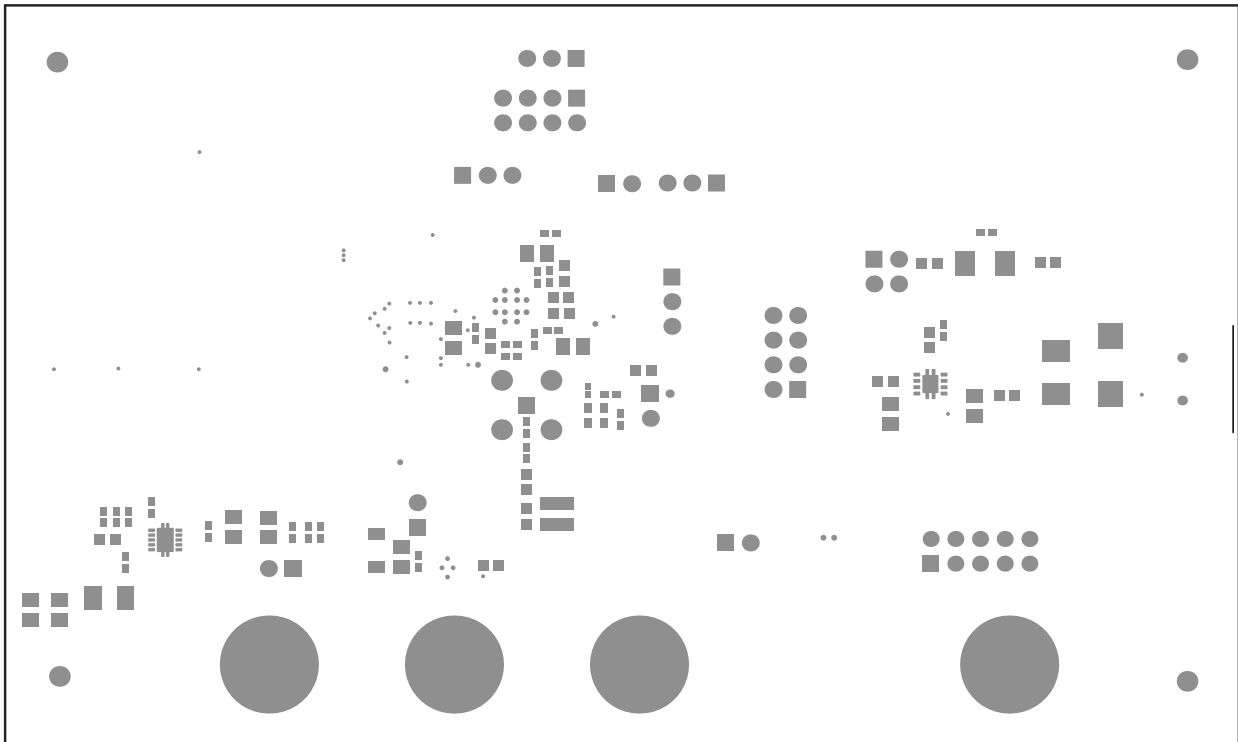


**Figure 6-8. Signal Layer 4**





**Figure 6-11. Bottom Paste**



**Figure 6-12. Bottom Solder**

## 7 Related Documentation

### 7.1 References

- [DS90UB953-Q1](#)
- [DS90UB953A-Q1](#)
- [DS90UB954-Q1](#)
- [TSER953](#)

## 8 Revision History

NOTE: Page numbers for previous revisions may differ from page numbers in the current version.

<b>Changes from Revision B (September 2020) to Revision C (April 2021)</b>	<b>Page</b>
• Updated Abstract section to include V <sup>3</sup> Link TSER953.....	<a href="#">1</a>
• Added link to TSER953 product page.....	<a href="#">53</a>

## IMPORTANT NOTICE AND DISCLAIMER

TI PROVIDES TECHNICAL AND RELIABILITY DATA (INCLUDING DATA SHEETS), DESIGN RESOURCES (INCLUDING REFERENCE DESIGNS), APPLICATION OR OTHER DESIGN ADVICE, WEB TOOLS, SAFETY INFORMATION, AND OTHER RESOURCES "AS IS" AND WITH ALL FAULTS, AND DISCLAIMS ALL WARRANTIES, EXPRESS AND IMPLIED, INCLUDING WITHOUT LIMITATION ANY IMPLIED WARRANTIES OF MERCHANTABILITY, FITNESS FOR A PARTICULAR PURPOSE OR NON-INFRINGEMENT OF THIRD PARTY INTELLECTUAL PROPERTY RIGHTS.

These resources are intended for skilled developers designing with TI products. You are solely responsible for (1) selecting the appropriate TI products for your application, (2) designing, validating and testing your application, and (3) ensuring your application meets applicable standards, and any other safety, security, regulatory or other requirements.

These resources are subject to change without notice. TI grants you permission to use these resources only for development of an application that uses the TI products described in the resource. Other reproduction and display of these resources is prohibited. No license is granted to any other TI intellectual property right or to any third party intellectual property right. TI disclaims responsibility for, and you will fully indemnify TI and its representatives against, any claims, damages, costs, losses, and liabilities arising out of your use of these resources.

TI's products are provided subject to [TI's Terms of Sale](#) or other applicable terms available either on [ti.com](http://ti.com) or provided in conjunction with such TI products. TI's provision of these resources does not expand or otherwise alter TI's applicable warranties or warranty disclaimers for TI products.

TI objects to and rejects any additional or different terms you may have proposed.

Mailing Address: Texas Instruments, Post Office Box 655303, Dallas, Texas 75265  
Copyright © 2022, Texas Instruments Incorporated