

## DS92LV090A 9 Channel Bus LVDS Transceiver

Check for Samples: [DS92LV090A](#)

### FEATURES

- Bus LVDS Signaling
- 3.2 Nanosecond Propagation Delay Max
- Chip to Chip Skew  $\pm 800$ ps
- Low Power CMOS Design
- High Signaling Rate Capability (Above 100 Mbps)
- 0.1V to 2.3V Common Mode Range for  $V_{ID} = 200$ mV
- $\pm 100$  mV Receiver Sensitivity
- Supports Open and Terminated Failsafe on Port Pins
- 3.3V Operation
- Glitch Free Power Up/Down (Driver & Receiver Disabled)
- Light Bus Loading (5 pF Typical) per Bus LVDS Load
- Designed for Double Termination Applications
- Balanced Output Impedance
- Product Offered in 64 Pin LQFP Package
- High Impedance Bus Pins on Power off ( $V_{CC} = 0$ V)
- Driver Channel to Channel Skew (Same Device) 230ps Typical
- Receiver Channel to Channel Skew (Same Device) 370ps Typical

### DESCRIPTION

The DS92LV090A is one in a series of Bus LVDS transceivers designed specifically for the high speed, low power proprietary backplane or cable interfaces. The device operates from a single 3.3V power supply and includes nine differential line drivers and nine receivers. To minimize bus loading, the driver outputs and receiver inputs are internally connected. The separate I/O of the logic side allows for loop back support. The device also features a flow through pin out which allows easy PCB routing for short stubs between its pins and the connector.

The driver translates 3V TTL levels (single-ended) to differential Bus LVDS (BLVDS) output levels. This allows for high speed operation, while consuming minimal power with reduced EMI. In addition, the differential signaling provides common mode noise rejection of  $\pm 1$ V.

The receiver threshold is less than  $\pm 100$  mV over a  $\pm 1$ V common mode range and translates the differential Bus LVDS to standard (TTL/CMOS) levels. (See [Applications Information](#) Section for more details.)

### Simplified Functional Diagram

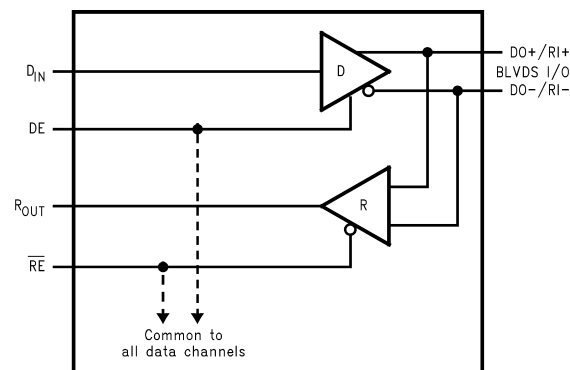
**Figure 1.**

Please be aware that an important notice concerning availability, standard warranty, and use in critical applications of Texas Instruments semiconductor products and disclaimers thereto appears at the end of this data sheet.

All trademarks are the property of their respective owners.

### Connection Diagram

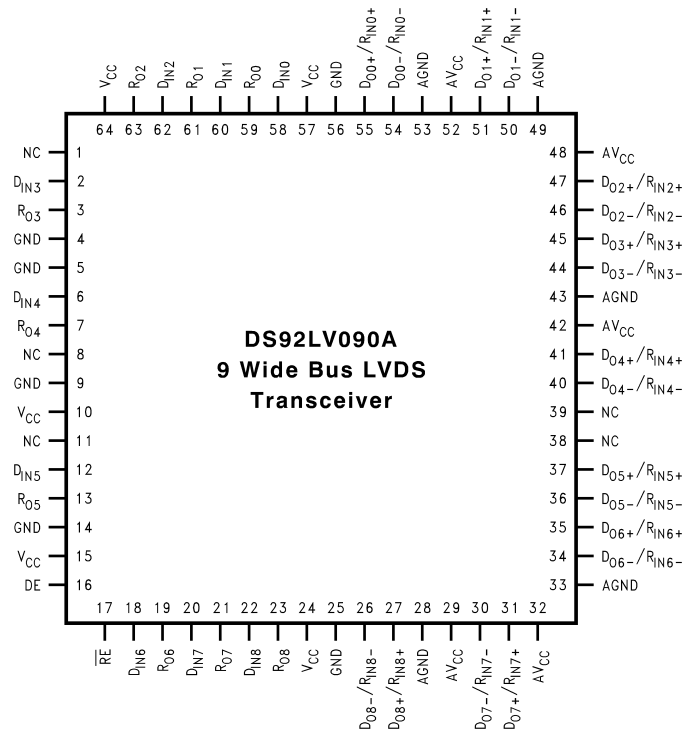

Figure 2. Top View Package Number PM0064

#### PIN DESCRIPTIONS

Pin Name	Pin #	Input/Output	Descriptions
DO+/RI+	27, 31, 35, 37, 41, 45, 47, 51, 55	I/O	True Bus LVDS Driver Outputs and Receiver Inputs.
DO-/RI-	26, 30, 34, 36, 40, 44, 46, 50, 54	I/O	Complimentary Bus LVDS Driver Outputs and Receiver Inputs.
DIN	2, 6, 12, 18, 20, 22, 58, 60, 62	I	TTL Driver Input.
RO	3, 7, 13, 19, 21, 23, 59, 61, 63	O	TTL Receiver Output.
RE	17	I	Receiver Enable TTL Input (Active Low).
DE	16	I	Driver Enable TTL Input (Active High).
GND	4, 5, 9, 14, 25, 56	Power	Ground for digital circuitry (must connect to GND on PC board). These pins connected internally.
VCC	10, 15, 24, 57, 64	Power	VCC for digital circuitry (must connect to VCC on PC board). These pins connected internally.
AGND	28, 33, 43, 49, 53	Power	Ground for analog circuitry (must connect to GND on PC board). These pins connected internally.
AVCC	29, 32, 42, 48, 52	Power	Analog VCC (must connect to VCC on PC board). These pins connected internally.
NC	1, 8, 11, 38, 39	N/A	Leave open circuit, do not connect.



These devices have limited built-in ESD protection. The leads should be shorted together or the device placed in conductive foam during storage or handling to prevent electrostatic damage to the MOS gates.

**Absolute Maximum Ratings** <sup>(1)(2)(3)</sup>

Supply Voltage ( $V_{CC}$ )		4.0V
Enable Input Voltage (DE, $\overline{RE}$ )		-0.3V to ( $V_{CC} + 0.3V$ )
Driver Input Voltage ( $D_{IN}$ )		-0.3V to ( $V_{CC} + 0.3V$ )
Receiver Output Voltage ( $R_{OUT}$ )		-0.3V to ( $V_{CC} + 0.3V$ )
Bus Pin Voltage (DO/RI±)		-0.3V to +3.9V
ESD (HBM 1.5 k $\Omega$ , 100 pF)		>4.5 kV
Driver Short Circuit Duration		momentary
Receiver Short Circuit Duration		momentary
Maximum Package Power Dissipation at 25°C	LQFP	1.74 W
	Derate LQFP Package	13.9 mW/°C
	$\theta_{ja}$	71.7°C/W
	$\theta_{jc}$	10.9°C/W
Junction Temperature		+150°C
Storage Temperature Range		-65°C to +150°C
Lead Temperature (Soldering, 4 sec.)		260°C

- (1) All currents into device pins are positive; all currents out of device pins are negative. All voltages are referenced to ground unless otherwise specified except  $V_{OD}$ ,  $\Delta V_{OD}$  and  $V_{ID}$ .
- (2) "Absolute Maximum Ratings" are those values beyond which the safety of the device cannot be ensured. They are not meant to imply that the devices should be operated at these limits. The table of "Electrical Characteristics" provides conditions for actual device operation.
- (3) If Military/Aerospace specified devices are required, please contact the Texas Instruments Sales Office/ Distributors for availability and specifications.

**Recommended Operating Conditions**

	Min	Max	Units
Supply Voltage ( $V_{CC}$ )	3.0	3.6	V
Receiver Input Voltage	0.0	2.4	V
Operating Free Air Temperature	-40	+85	°C
Maximum Input Edge Rate (20% to 80%) <sup>(1)</sup>			$\Delta t/\Delta V$
Data		1.0	ns/V
Control		3.0	ns/V

- (1) Generator waveforms for all tests unless otherwise specified:  $f = 25$  MHz,  $Z_O = 50\Omega$ ,  $t_r, t_f = <1.0$  ns (0%–100%). To ensure fastest propagation delay and minimum skew, data input edge rates should be equal to or faster than 1ns/V; control signals equal to or faster than 3ns/V. In general, the faster the input edge rate, the better the AC performance.

## DC Electrical Characteristics

Over recommended operating supply voltage and temperature ranges unless otherwise specified <sup>(1)(2)</sup>

Symbol	Parameter	Conditions	Pin	Min	Typ	Max	Units	
V <sub>OD</sub>	Output Differential Voltage	R <sub>L</sub> = 27Ω, <a href="#">Figure 3</a>	DO+/RI+, DO-/RI-	240	300	460	mV	
ΔV <sub>OD</sub>	V <sub>OD</sub> Magnitude Change					27	mV	
V <sub>OS</sub>	Offset Voltage			1.1	1.3	1.5	V	
ΔV <sub>OS</sub>	Offset Magnitude Change				5	10	mV	
V <sub>OH</sub>	Driver Output High Voltage <sup>(3)</sup>	R <sub>L</sub> = 27Ω	R <sub>OUT</sub>		1.4	1.65	V	
V <sub>OL</sub>	Driver Output Low Voltage <sup>(3)</sup>	R <sub>L</sub> = 27Ω		0.95	1.1		V	
I <sub>OSD</sub>	Output Short Circuit Current <sup>(4)</sup>	V <sub>OD</sub> = 0V, DE = V <sub>CC</sub> , Driver outputs shorted together				[36]	[65]	mA
V <sub>OH</sub>	Voltage Output High <sup>(5)</sup>	V <sub>ID</sub> = +300 mV		I <sub>OH</sub> = -400 μA	V <sub>CC</sub> -0.2			V
		Inputs Open			V <sub>CC</sub> -0.2			V
		Inputs Terminated, R <sub>L</sub> = 27Ω			V <sub>CC</sub> -0.2			V
V <sub>OL</sub>	Voltage Output Low	I <sub>OL</sub> = 2.0 mA, V <sub>ID</sub> = -300 mV		0.05	0.075	V		
I <sub>OD</sub>	Receiver Output Dynamic Current <sup>(4)</sup>	V <sub>ID</sub> = 300mV, V <sub>OUT</sub> = V <sub>CC</sub> -1.0V		-110	[75]		mA	
		V <sub>ID</sub> = -300mV, V <sub>OUT</sub> = 1.0V			[75]	110	mA	
V <sub>TH</sub>	Input Threshold High	DE = 0V, V <sub>CM</sub> = 1.5V	DO+/RI+, DO-/RI-			+100	mV	
V <sub>TL</sub>	Input Threshold Low			-100			mV	
V <sub>CMR</sub>	Receiver Common Mode Range			V <sub>ID</sub>  /2		2.4 -  V <sub>ID</sub>  /2		V
I <sub>IN</sub>	Input Current	DE = 0V, $\overline{RE}$ = 2.4V, V <sub>IN</sub> = +2.4V or 0V		-20	±1	+20	μA	
		V <sub>CC</sub> = 0V, V <sub>IN</sub> = +2.4V or 0V		-20	±1	+20	μA	
V <sub>IH</sub>	Minimum Input High Voltage	D <sub>IN</sub> , DE, $\overline{RE}$	V <sub>CC</sub>	2.0		V <sub>CC</sub>	V	
V <sub>IL</sub>	Maximum Input Low Voltage			GND		0.8	V	
I <sub>IH</sub>	Input High Current			V <sub>IN</sub> = V <sub>CC</sub> or 2.4V	-20	±10	+20	μA
I <sub>IL</sub>	Input Low Current			V <sub>IN</sub> = GND or 0.4V	-20	±10	+20	μA
V <sub>CL</sub>	Input Diode Clamp Voltage			I <sub>CLAMP</sub> = -18 mA	-1.5	-0.8		V
I <sub>CCD</sub>	Power Supply Current Drivers Enabled, Receivers Disabled			No Load, DE = $\overline{RE}$ = V <sub>CC</sub> , D <sub>IN</sub> = V <sub>CC</sub> or GND			55	80
I <sub>CCR</sub>	Power Supply Current Drivers Disabled, Receivers Enabled	DE = $\overline{RE}$ = 0V, V <sub>ID</sub> = ±300mV			73	80	mA	
I <sub>CCZ</sub>	Power Supply Current, Drivers and Receivers TRI-STATE	DE = 0V; $\overline{RE}$ = V <sub>CC</sub> , D <sub>IN</sub> = V <sub>CC</sub> or GND			35	80	mA	
I <sub>CC</sub>	Power Supply Current, Drivers and Receivers Enabled	DE = V <sub>CC</sub> ; $\overline{RE}$ = 0V, D <sub>IN</sub> = V <sub>CC</sub> or GND, R <sub>L</sub> = 27Ω			170	210	mA	
I <sub>OFF</sub>	Power Off Leakage Current	V <sub>CC</sub> = 0V or OPEN, D <sub>IN</sub> , DE, $\overline{RE}$ = 0V or OPEN, V <sub>APPLIED</sub> = 3.6V (Port Pins)	DO+/RI+, DO-/RI-	-20		+20	μA	
C <sub>OUTPUT</sub>	Capacitance @ Bus Pins		DO+/RI+, DO-/RI-		5		pF	
C <sub>OUTPUT</sub>	Capacitance @ R <sub>OUT</sub>		R <sub>OUT</sub>		7		pF	

(1) All currents into device pins are positive; all currents out of device pins are negative. All voltages are referenced to ground unless otherwise specified except V<sub>OD</sub>, ΔV<sub>OD</sub> and V<sub>ID</sub>.

(2) All typicals are given for V<sub>CC</sub> = +3.3V and T<sub>A</sub> = +25°C, unless otherwise stated.

(3) The DS92LV090A functions within datasheet specification when a resistive load is applied to the driver outputs.

(4) Only one output at a time should be shorted, do not exceed maximum package power dissipation capacity.

(5) V<sub>OH</sub> failsafe terminated test performed with 27Ω connected between RI+ and RI- inputs. No external voltage is applied.

## AC Electrical Characteristics

Over recommended operating supply voltage and temperature ranges unless otherwise specified <sup>(1)</sup>

Symbol	Parameter	Conditions	Min	Typ	Max	Units
<b>DIFFERENTIAL DRIVER TIMING REQUIREMENTS</b>						
$t_{PHLD}$	Differential Prop. Delay High to Low <sup>(2)</sup>	$R_L = 27\Omega$ , Figure 4, Figure 5, $C_L = 10\text{ pF}$	0.6	1.4	2.2	ns
$t_{PLHD}$	Differential Prop. Delay Low to High <sup>(2)</sup>		0.6	1.4	2.2	ns
$t_{SKD1}$	Differential Skew $ t_{PHLD} - t_{PLHD} $ <sup>(3)</sup>			80		ps
$t_{SKD2}$	Chip to Chip Skew <sup>(4)</sup>				1.6	ns
$t_{SKD3}$	Channel to Channel Skew <sup>(5)</sup>			0.25	0.45	ns
$t_{TLH}$	Transition Time Low to High				0.6	1.2
$t_{THL}$	Transition Time High to Low			0.5	1.2	ns
$t_{PHZ}$	Disable Time High to Z	$R_L = 27\Omega$ , Figure 6, Figure 7, $C_L = 10\text{ pF}$		3	8	ns
$t_{PLZ}$	Disable Time Low to Z			3	8	ns
$t_{PZH}$	Enable Time Z to High			3	8	ns
$t_{PZL}$	Enable Time Z to Low			3	8	ns
<b>DIFFERENTIAL RECEIVER TIMING REQUIREMENTS</b>						
$t_{PHLD}$	Differential Prop. Delay High to Low <sup>(2)</sup>	Figure 8, Figure 9, $C_L = 35\text{ pF}$	1.6	2.4	3.2	ns
$t_{PLHD}$	Differential Prop Delay Low to High <sup>(2)</sup>		1.6	2.4	3.2	ns
$t_{SDK1}$	Differential Skew $ t_{PHLD} - t_{PLHD} $ <sup>(3)</sup>			80		ps
$t_{SDK2}$	Chip to Chip Skew <sup>(4)</sup>				1.6	ns
$t_{SDK3}$	Channel to Channel Skew <sup>(5)</sup>			0.35	0.60	ns
$t_{TLH}$	Transition Time Low to High				1.5	2.5
$t_{THL}$	Transition Time High to Low			1.5	2.5	ns
$t_{PHZ}$	Disable Time High to Z	$R_L = 500\Omega$ , Figure 10, Figure 11, $C_L = 35\text{ pF}$		4.5	10	ns
$t_{PLZ}$	Disable Time Low to Z			3.5	8	ns
$t_{PZH}$	Enable Time Z to High			3.5	8	ns
$t_{PZL}$	Enable Time Z to Low			3.5	8	ns

- (1) Generator waveforms for all tests unless otherwise specified:  $f = 25\text{ MHz}$ ,  $Z_O = 50\Omega$ ,  $t_r, t_f = <1.0\text{ ns}$  (0%–100%). To ensure fastest propagation delay and minimum skew, data input edge rates should be equal to or faster than  $1\text{ ns/V}$ ; control signals equal to or faster than  $3\text{ ns/V}$ . In general, the faster the input edge rate, the better the AC performance.
- (2) Propagation delays are specified by design and characterization.
- (3)  $t_{SKD1} |t_{PHLD} - t_{PLHD}|$  is the worse case skew between any channel and any device over recommended operation conditions.
- (4) Chip to Chip skew is the difference in differential propagation delay between any channels of any devices, either edge.
- (5) Channel to Channel skew is the difference in driver output or receiver output propagation delay between any channels within a device, either edge.

## APPLICATIONS INFORMATION

General application guidelines and hints may be found in the following application notes: AN-808 ([SNLA028](#)), AN-903 ([SNLA034](#)), AN-971 ([SNLA165](#)), AN-977 ([SNLA166](#)), and AN-1108 ([SNLA008](#)).

There are a few common practices which should be implied when designing PCB for Bus LVDS signaling. Recommended practices are:

- Use at least 4 PCB board layer (Bus LVDS signals, ground, power and TTL signals).
- Keep drivers and receivers as close to the (Bus LVDS port side) connector as possible.
- Bypass each Bus LVDS device and also use distributed bulk capacitance between power planes. Surface mount capacitors placed close to power and ground pins work best. Two or three high frequency, multi-layer ceramic (MLC) surface mount (0.1  $\mu\text{F}$ , 0.01  $\mu\text{F}$ , 0.001  $\mu\text{F}$ ) in parallel should be used between each  $V_{\text{CC}}$  and ground. The capacitors should be as close as possible to the  $V_{\text{CC}}$  pin.
  - Multiple vias should be used to connect  $V_{\text{CC}}$  and Ground planes to the pads of the by-pass capacitors.
  - In addition, randomly distributed by-pass capacitors should be used.
- Use the termination resistor which best matches the differential impedance of your transmission line.
- Leave unused Bus LVDS receiver inputs open (floating). Limit traces on unused inputs to <0.5 inches.
- Isolate TTL signals from Bus LVDS signals

### MEDIA (CONNECTOR or BACKPLANE) SELECTION:

- Use controlled impedance media. The backplane and connectors should have a matched differential impedance.

**Table 1. Functional Table**

MODE SELECTED	DE	$\overline{\text{RE}}$
DRIVER MODE	H	H
RECEIVER MODE	L	L
TRI-STATE MODE	L	H
LOOP BACK MODE	H	L

**Table 2. Transmitter Mode**

INPUTS		OUTPUTS	
DE	$D_{\text{IN}}$	DO+	DO-
H	L	L	H
H	H	H	L
H	$0.8\text{V} < D_{\text{IN}} < 2.0\text{V}$	X	X
L	X	Z	Z

**Table 3. Receiver Mode<sup>(1)</sup>**

INPUTS		OUTPUT
$\overline{\text{RE}}$	(RI+) – (RI-)	
L	L (< -100 mV)	L
L	H (> +100 mV)	H
L	$-100\text{ mV} < V_{\text{ID}} < +100\text{ mV}$	X
H	X	Z

- (1) X = High or Low logic state  
 L = Low state  
 Z = High impedance state  
 H = High state

Test Circuits and Timing Waveforms

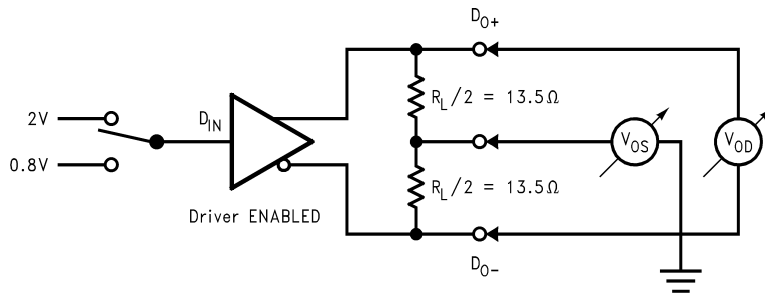

Figure 3. Differential Driver DC Test Circuit

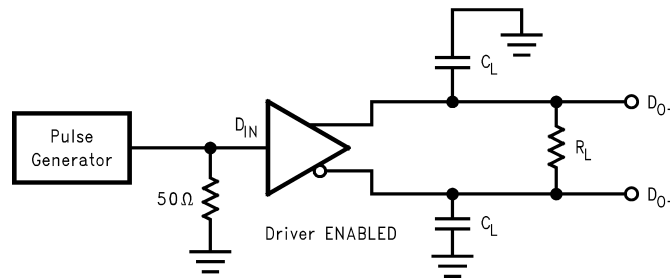

Figure 4. Differential Driver Propagation Delay and Transition Time Test Circuit

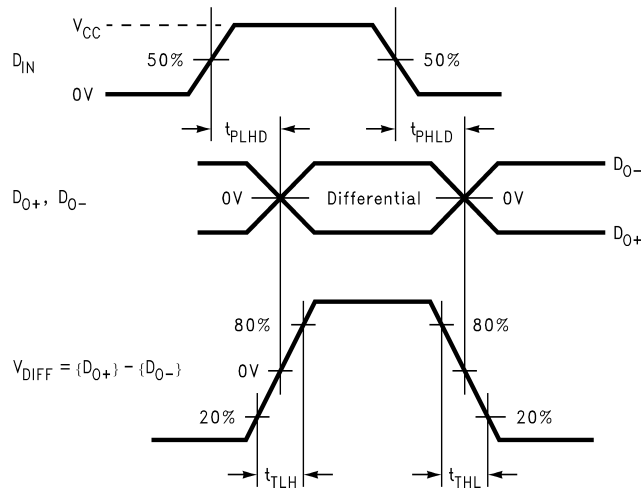

Figure 5. Differential Driver Propagation Delay and Transition Time Waveforms

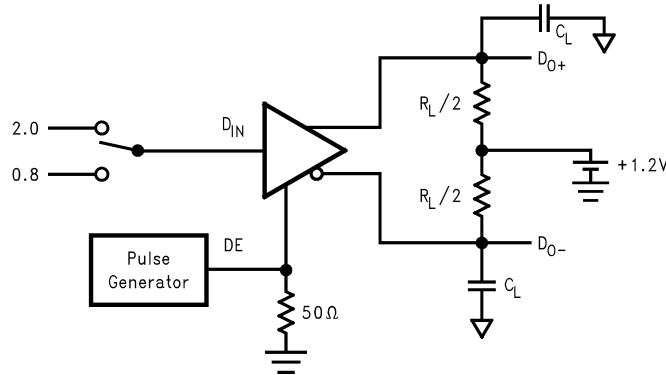

Figure 6. Driver TRI-STATE Delay Test Circuit

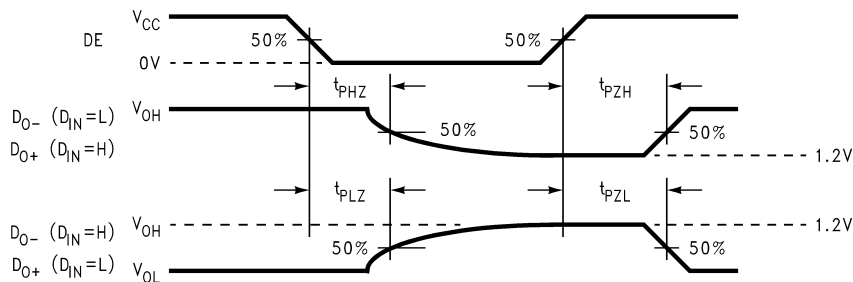

Figure 7. Driver TRI-STATE Delay Waveforms

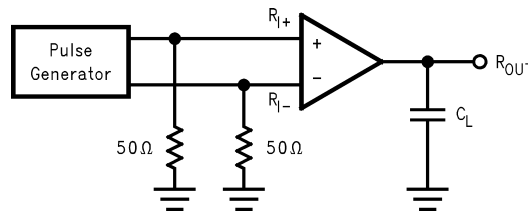

Figure 8. Receiver Propagation Delay and Transition Time Test Circuit

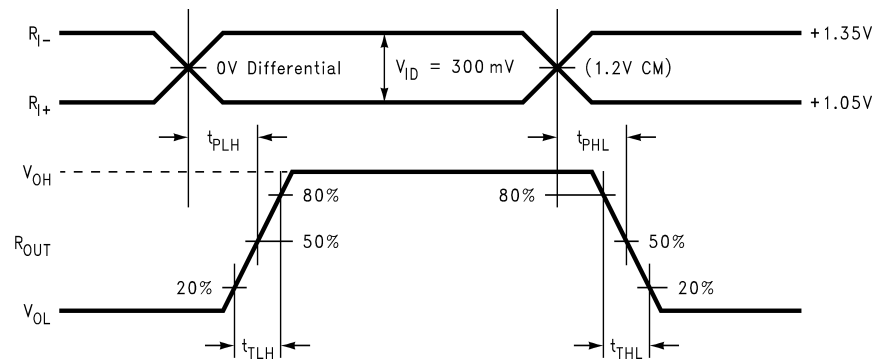

Figure 9. Receiver Propagation Delay and Transition Time Waveforms



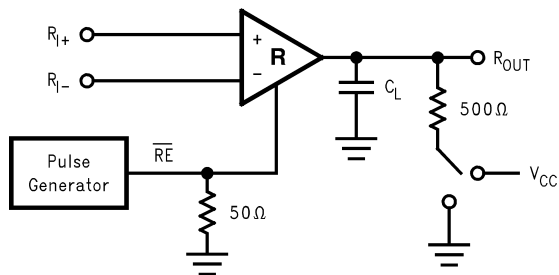

Figure 10. Receiver TRI-STATE Delay Test Circuit

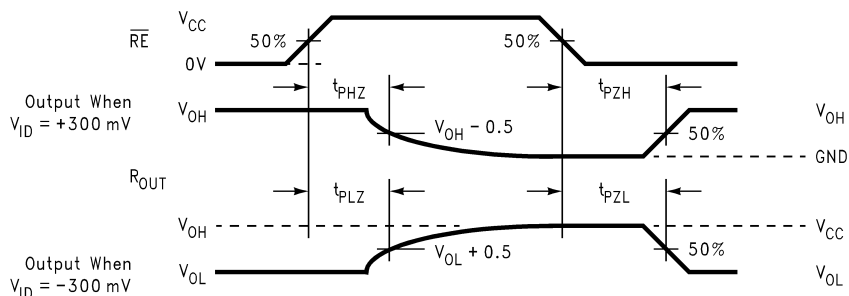

Figure 11. Receiver TRI-STATE Delay Waveforms

Typical Bus Application Configurations

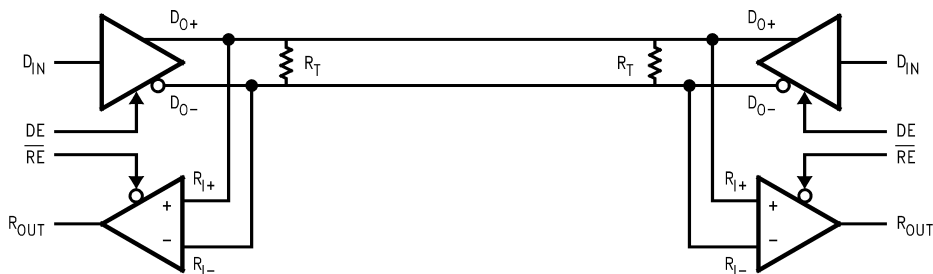

Figure 12. Bi-Directional Half-Duplex Point-to-Point Applications

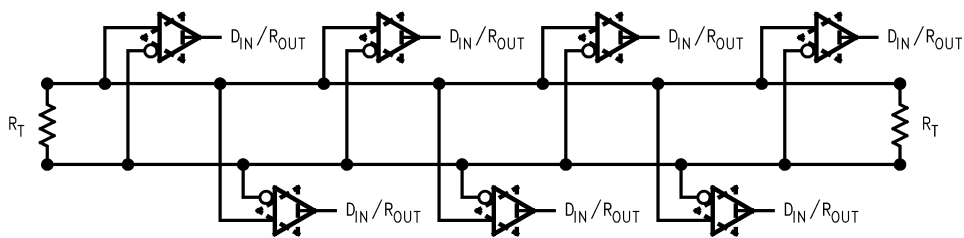



Figure 13. Multi-Point Bus Applications

## REVISION HISTORY

Changes from Revision C (April 2013) to Revision D	Page
• Changed layout of National Data Sheet to TI format .....	<a href="#">9</a>

**PACKAGING INFORMATION**

Orderable Device	Status (1)	Package Type	Package Drawing	Pins	Package Qty	Eco Plan (2)	Lead finish/ Ball material (6)	MSL Peak Temp (3)	Op Temp (°C)	Device Marking (4/5)	Samples
DS92LV090ATVEH/NOPB	ACTIVE	LQFP	PM	64	160	RoHS & Green	SN	Level-3-260C-168 HR	-40 to 85	DS92LV090A TVEH	
DS92LV090ATVEHX/NOPB	ACTIVE	LQFP	PM	64	1000	RoHS & Green	SN	Level-3-260C-168 HR	-40 to 85	DS92LV090A TVEH	

(1) The marketing status values are defined as follows:

**ACTIVE:** Product device recommended for new designs.

**LIFEBUY:** TI has announced that the device will be discontinued, and a lifetime-buy period is in effect.

**NRND:** Not recommended for new designs. Device is in production to support existing customers, but TI does not recommend using this part in a new design.

**PREVIEW:** Device has been announced but is not in production. Samples may or may not be available.

**OBSOLETE:** TI has discontinued the production of the device.

(2) **RoHS:** TI defines "RoHS" to mean semiconductor products that are compliant with the current EU RoHS requirements for all 10 RoHS substances, including the requirement that RoHS substance do not exceed 0.1% by weight in homogeneous materials. Where designed to be soldered at high temperatures, "RoHS" products are suitable for use in specified lead-free processes. TI may reference these types of products as "Pb-Free".

**RoHS Exempt:** TI defines "RoHS Exempt" to mean products that contain lead but are compliant with EU RoHS pursuant to a specific EU RoHS exemption.

**Green:** TI defines "Green" to mean the content of Chlorine (Cl) and Bromine (Br) based flame retardants meet JS709B low halogen requirements of <=1000ppm threshold. Antimony trioxide based flame retardants must also meet the <=1000ppm threshold requirement.

(3) MSL, Peak Temp. - The Moisture Sensitivity Level rating according to the JEDEC industry standard classifications, and peak solder temperature.

(4) There may be additional marking, which relates to the logo, the lot trace code information, or the environmental category on the device.

(5) Multiple Device Markings will be inside parentheses. Only one Device Marking contained in parentheses and separated by a "~" will appear on a device. If a line is indented then it is a continuation of the previous line and the two combined represent the entire Device Marking for that device.

(6) Lead finish/Ball material - Orderable Devices may have multiple material finish options. Finish options are separated by a vertical ruled line. Lead finish/Ball material values may wrap to two lines if the finish value exceeds the maximum column width.

**Important Information and Disclaimer:**The information provided on this page represents TI's knowledge and belief as of the date that it is provided. TI bases its knowledge and belief on information provided by third parties, and makes no representation or warranty as to the accuracy of such information. Efforts are underway to better integrate information from third parties. TI has taken and continues to take reasonable steps to provide representative and accurate information but may not have conducted destructive testing or chemical analysis on incoming materials and chemicals. TI and TI suppliers consider certain information to be proprietary, and thus CAS numbers and other limited information may not be available for release.

In no event shall TI's liability arising out of such information exceed the total purchase price of the TI part(s) at issue in this document sold by TI to Customer on an annual basis.



**TAPE AND REEL INFORMATION**

**QUADRANT ASSIGNMENTS FOR PIN 1 ORIENTATION IN TAPE**

\*All dimensions are nominal

Device	Package Type	Package Drawing	Pins	SPQ	Reel Diameter (mm)	Reel Width W1 (mm)	A0 (mm)	B0 (mm)	K0 (mm)	P1 (mm)	W (mm)	Pin1 Quadrant
DS92LV090ATVEHX/NOPB	LQFP	PM	64	1000	330.0	24.4	12.35	12.35	2.2	16.0	24.0	Q2

**TAPE AND REEL BOX DIMENSIONS**

\*All dimensions are nominal

Device	Package Type	Package Drawing	Pins	SPQ	Length (mm)	Width (mm)	Height (mm)
DS92LV090ATVEHX/ NOPB	LQFP	PM	64	1000	367.0	367.0	45.0

**TRAY**



Chamfer on Tray corner indicates Pin 1 orientation of packed units.

\*All dimensions are nominal

Device	Package Name	Package Type	Pins	SPQ	Unit array matrix	Max temperature (°C)	L (mm)	W (mm)	K0 (µm)	P1 (mm)	CL (mm)	CW (mm)
DS92LV090ATVEH/ NOPB	PM	LQFP	64	160	8 X 20	150	322.6	135.9	7620	15.2	13.1	13

# PM0064A



## PACKAGE OUTLINE

LQFP - 1.6 mm max height

PLASTIC QUAD FLATPACK



4215162/A 03/2017

### NOTES:

1. All linear dimensions are in millimeters. Any dimensions in parenthesis are for reference only. Dimensioning and tolerancing per ASME Y14.5M.
2. This drawing is subject to change without notice.
3. This dimension does not include mold flash, protrusions, or gate burrs. Mold flash, protrusions, or gate burrs shall not exceed 0.15 mm per side.
4. Reference JEDEC registration MS-026.



# EXAMPLE BOARD LAYOUT

PM0064A

LQFP - 1.6 mm max height

PLASTIC QUAD FLATPACK



LAND PATTERN EXAMPLE  
EXPOSED METAL SHOWN  
SCALE:8X



SOLDER MASK DETAILS

4215162/A 03/2017

NOTES: (continued)

5. Publication IPC-7351 may have alternate designs.
6. Solder mask tolerances between and around signal pads can vary based on board fabrication site.
7. For more information, see Texas Instruments literature number SLMA004 ([www.ti.com/lit/slma004](http://www.ti.com/lit/slma004)).

# EXAMPLE STENCIL DESIGN

PM0064A

LQFP - 1.6 mm max height

PLASTIC QUAD FLATPACK



NOTES: (continued)

8. Laser cutting apertures with trapezoidal walls and rounded corners may offer better paste release. IPC-7525 may have alternate design recommendations.
9. Board assembly site may have different recommendations for stencil design.

## IMPORTANT NOTICE AND DISCLAIMER

TI PROVIDES TECHNICAL AND RELIABILITY DATA (INCLUDING DATA SHEETS), DESIGN RESOURCES (INCLUDING REFERENCE DESIGNS), APPLICATION OR OTHER DESIGN ADVICE, WEB TOOLS, SAFETY INFORMATION, AND OTHER RESOURCES "AS IS" AND WITH ALL FAULTS, AND DISCLAIMS ALL WARRANTIES, EXPRESS AND IMPLIED, INCLUDING WITHOUT LIMITATION ANY IMPLIED WARRANTIES OF MERCHANTABILITY, FITNESS FOR A PARTICULAR PURPOSE OR NON-INFRINGEMENT OF THIRD PARTY INTELLECTUAL PROPERTY RIGHTS.

These resources are intended for skilled developers designing with TI products. You are solely responsible for (1) selecting the appropriate TI products for your application, (2) designing, validating and testing your application, and (3) ensuring your application meets applicable standards, and any other safety, security, regulatory or other requirements.

These resources are subject to change without notice. TI grants you permission to use these resources only for development of an application that uses the TI products described in the resource. Other reproduction and display of these resources is prohibited. No license is granted to any other TI intellectual property right or to any third party intellectual property right. TI disclaims responsibility for, and you will fully indemnify TI and its representatives against, any claims, damages, costs, losses, and liabilities arising out of your use of these resources.

TI's products are provided subject to [TI's Terms of Sale](#) or other applicable terms available either on [ti.com](http://ti.com) or provided in conjunction with such TI products. TI's provision of these resources does not expand or otherwise alter TI's applicable warranties or warranty disclaimers for TI products.

TI objects to and rejects any additional or different terms you may have proposed.

Mailing Address: Texas Instruments, Post Office Box 655303, Dallas, Texas 75265  
Copyright © 2022, Texas Instruments Incorporated