

LM25576 Reference Design 6-42V input, 5V 3A output

National Semiconductor
Reference Design 128
Richard Levin
January 2007



1.0 Design Specifications

Inputs	Output #1
vInMin=6V	vOut1=5V
vInMax=42V	iOut1=3A

2.0 Design Description

This LM25576 reference design is based on a LM25576 demonstration board which was assembled and tested platform to evaluate the LM25576 SIMPLE SWITCHER® step-down converter. The reference design takes a 6V-42V input and generates a regulated 5V output that can source up to 3A of current.

Design Targets

The primary consideration for this design was to obtain the highest efficiency LM25576 design, over its full operating voltage input range. Cost and size of components were a secondary consideration (i.e.: using small, less expensive ceramic capacitors; a small, off the shelf inductor; etc.). The result is a design that achieves 95% peak efficiency, with a short list of necessary components. All optional features of the LM25576 can be enabled if necessary. The board layout is ideal for demonstrating the capabilities of the target design, while allowing for easy probing and adjustments.

Product Description

The LM25576 is an easy to use Simple Switcher buck regulator which allows design engineers to design and optimize a robust power supply using a minimum set of components. Operating with an input voltage range of 6 - 42V, the LM25576 delivers 3A of continuous output current with an integrated 170 mΩ N-Channel MOSFET. The regulator utilizes an Emulated Current Mode architecture which provides inherent line regulation, tight load transient response, and ease of loop compensation without the usual limitation on low-duty cycles associated with current mode regulators. The operating fre-

quency is adjustable from 50 kHz to 1 MHz to allow optimization of size and efficiency. To reduce EMI, a frequency synchronization pin allows multiple IC's from the LM2557x family to self-synchronize or to synchronize to an external clock. The LM25576 guarantees robustness with cycle-by-cycle current limit, short-circuit protection, thermal shut-down, and remote shut-down. The device is available in a power enhanced TSSOP-20 package featuring an exposed die attach pad for thermal dissipation.

The LM25576 is supported by the full suite of WEBENCH® On-Line design tools

3.0 Features

- SIMPLE SWITCHER® regulator
- 6-42V input operation
- Synchronizable switching frequency
- Regulated 5V output at up to 3A
- 300 kHz switching frequency
- Easily adjustable output voltage down to 1.225V
- 95% maximum efficiency
- On-board shutdown circuitry
- Also demonstrates LM5576
- Integrated WEBENCH design
- RoHS compliant
- Design was assembled and tested

Applications

- Step-down 36V, 24V, or 12V rail to regulated 5V output
- Robust, industrial power supply
- Automotive applications
- White goods power supplies

4.0 Schematic

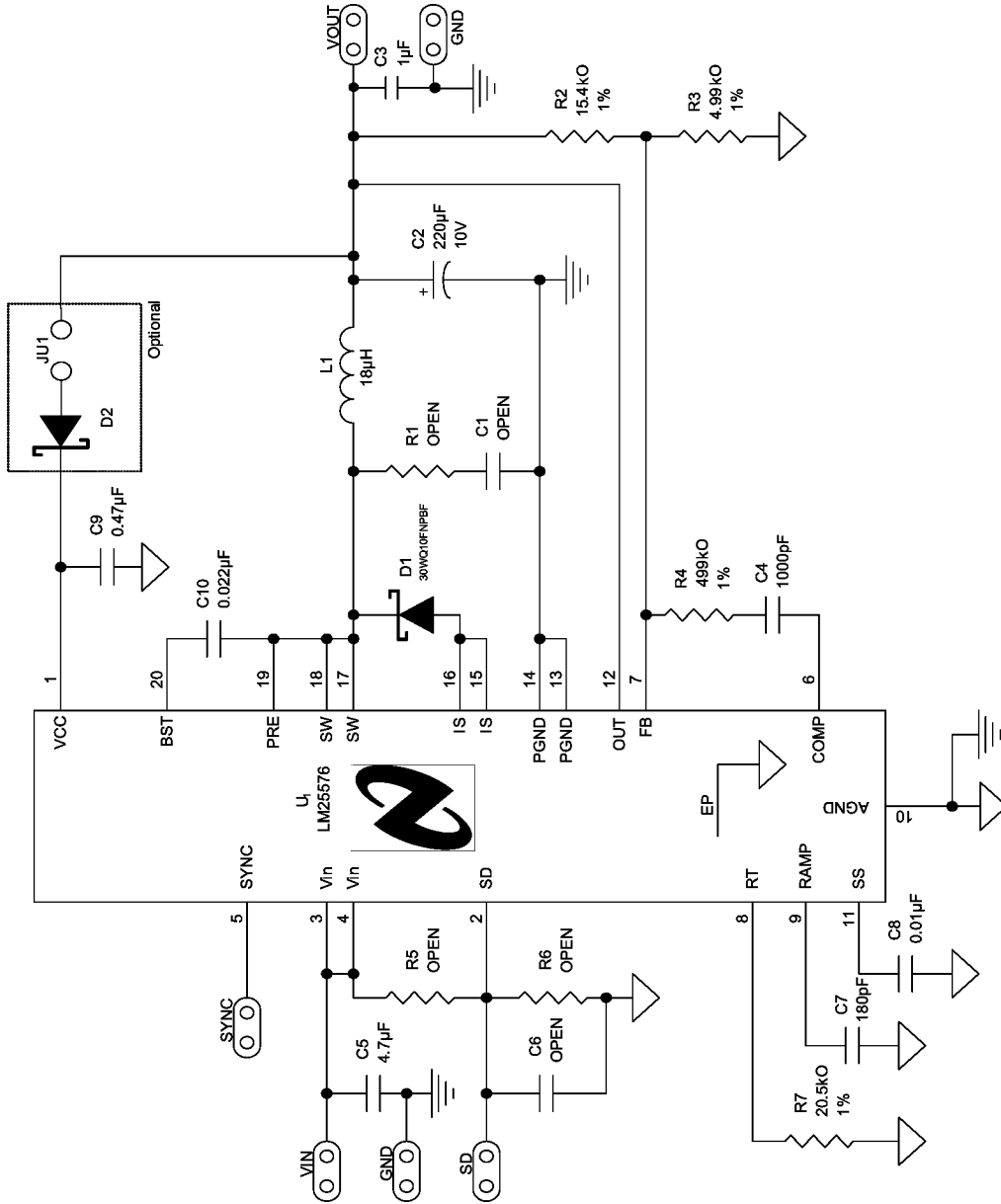

schematic1

FIGURE 1. LM25576 Demonstration Board Schematic

5.0 Bill Of Materials

Ref	Qty	Description	Supplier	Digi-Key part number
C1	0	Not Installed (0805)		
C2	1	220 μ F, 10V, 25m Ω tantalum capacitor (D-Case)	Kemet T520D227M010ASE025	Digi-Key 399-3260-1-ND
C3	1	1.0 μ F, 16V, X5R 10% 0603 Ceramic capacitor	TDK C1608X5R1C105K	Digi-Key 445-1416-1-ND
C4	1	CAP CER 1000pF 50V C0G 5%	TDK C1005C0G1E102J	Digi-Key 445-2651-1-ND
C5	1	4.7 μ F, 100V, X7R, 20% ceramic capacitor (2220)	TDK C5750X7R2A475M Murata GRM55ER72A475KA01L	Digi-Key 445-1450-1-ND Digi-Key 490-1934-1-ND
C6	0	Not Installed (0603)		
C7	1	180pF, 50V, C0G, 5% ceramic capacitor (0402)	TDK C1005C0G1H181J Murata GRM1555C1H181JA01D	Digi-Key 445-1250-1-ND Digi-Key 490-3231-1-ND
C8	2	0.01 μ F, 16V, X7R, 20% ceramic capacitor (0402)	TDK C1005X7R1C103K Murata GRM155R71C103KA01D	Digi-Key 445-1262-1-ND Digi-Key 490-1313-1-ND
C9	1	0.47 μ F, 16V, X7R, 10% ceramic capacitor (0805)	TDK C2012X7R1C474K Murata GRM21BR71C474KA01L	Digi-Key 445-1357-1-ND Digi-Key 490-3333-1-ND
D1	1	100V, 3.5A Schottky Diode (D-Pak)	IRF 30WQ10FNPBF	*Digi-Key 30EWQ10FN-ND
D2	1	40V, 30mA Shottky Diode (SOD-523)	Diodes Inc SDM03U40-7	Digi-Key SDM03U40DICT-ND
L1	1	18 μ H, 3.9A Inductor	Sumida CDRH127-180MC Toko 931BS-180M	Digi-Key 308-1080-1-ND
R1, R5, R6	0	Not Installed (0603)		
R2	1	15.4k Ω , 1% Resistor (0603)	Panasonic ERJ-3EKF1542V Yageo RC0603FR-0715K4L	Digi-Key P15.4KHCT-ND Digi-Key 311-15.4KHRCT-ND
R3	1	4.99k Ω , 1% Resistor (0603)	Panasonic ERJ-3EKF4991V Yageo RC0603FR-074K99L	Digi-Key P4.99KHCT-ND Digi-Key 311-4.99KHRCT-ND
R4	1	499k Ω , 1% Resistor (0603)	Panasonic ERJ-3EKF4993V Yageo RC0603FR-07499KL	Digi-Key P499KHCT-ND Digi-Key 311-499KHRCT-ND
R7	1	20.5k Ω , 1% Resistor (0603)	Panasonic ERJ-3EKF2052V Yageo RC0603FR-0720K5L	Digi-Key P20.5KHCT-ND Digi-Key 311-20.5KHRCT-ND
U1	1	Simple Switcher Step-Down Regulator (TSSOP-20EP)	National LM25576MH	

*Digi-Key component may not be lead-free

Component Suppliers

SUPPLIER	PHONE	WEBSITE
Digi-Key	800-344-4539	www.digikey.com
Diodes INC	805-446-4800	www.diodes.com
International Rectifier	310-726-8000	www.irf.com
Kemet	864-963-6300	www.kemet.com
Murata	770-436-1300	www.murata.com
TDK	847-803-6100	www.component.tdk.com

Note: Please indicate that you are using the LM25576 when contacting these component suppliers.

6.0 Other Operating Values

Operating Values

Description	Parameter	Value	Unit
Modulation Frequency	Frequency	300	KHz
Total output power	P _{out}	12.5	W
Steady State Efficiency	Efficiency	95	%
Control scheme	Control scheme	Emulated Current Control	
Peak-to-peak ripple voltage	V _{out} p-p	75	mV

7.0 Board Photos

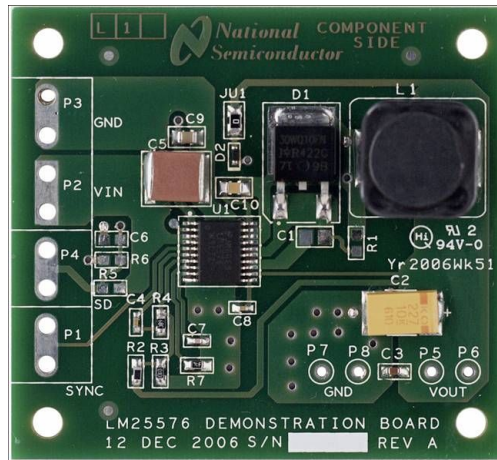

boardphoto3

FIGURE 2. Board Photo

8.0 Quick Start

Recommended Equipment

- 6V-42V/3A DC power supply
- 3A electronic load
- 1 voltmeter

Test Procedure

The LM25576 reference design was fully assembled and tested. Follow the steps below to verify your board operation. Do not turn on the power supplies until all connections are completed.

1. Connect the 6V-42V power supply to the V_{IN} and GND pads on the demonstration board.
2. Connect the electronic load to the V_{OUT} and GND pads.
3. Connect the voltmeter to the V_{OUT} and GND pads.
4. Set the 6V-42V power supply to output 28V.
5. Set the electronic load to draw 3.0A
6. Enable the 6V-42V power supply.
7. Enable the electronic load.
8. Verify that the voltmeter measures 5V at the power supply output.

9.0 Hardware Description

Detailed Description

The LM25576 demonstration board is a complete evaluation system for the LM25576 SIMPLE SWITCHER® step-down switching regulator.

The reference design accepts a 6V-42V input and produces a regulated 5V output that sources up to 3A of current. Multiple LM25576 reference design are easily synchronized to each other via on-board connection points. An analog shut-down input, and capacitor programmable soft-start functions are also available.

The LM25576 reference design is also able to demonstrate the LM5576 (6V-70V) input.

Additional design support is available via the WEBENCH design tool.

Powering V_{CC} From The Output Voltage

The LM25576 reference design features additional circuitry that powers the IC internals from the power output. This optional circuitry (D1, JU1) is included to improve efficiency when the input voltage is high. Buck regulators operating with high input voltage can dissipate an appreciable amount of power for the bias of the IC. The internal V_{CC} regulator must step-down the input voltage V_{IN} to a nominal V_{CC} level of 7V.

This large voltage drop across the V_{CC} regulator translates into large power dissipation within the V_{CC} regulator. This power dissipation becomes a dominant portion of the circuit efficiency when the load current is light.

Jumper JU1 connects the output voltage to the LM25576's V_{CC} input via diode D2. Since this design is configured for a 5V output voltage, the diode is back biased and the output voltage is not connected. When you alter the design such that the output voltage is in the range of $\sim 8V$ to $<14V$, the internal V_{CC} will shut off, and the overall design power consumption will be reduced. Please see the "BIAS POWER DISSIPATION REDUCTION" section of the datasheet for more details.

Setting the Output Voltage

By default the LM25576 demonstration board is designed to generate a 5V output. The output voltage of the LM25576 reference design can be changed via resistors R2 and R3. If the output voltage is changed significantly, recalculate components L1, C2, and loop compensation components R4 and C4. Refer to the LM25576 datasheet for details on how to calculate component values. If only moderate output voltage changes are made, the loop gain will remain more or less constant if only R3 is changed. R2, in conjunction with C4 and R4, sets the error amplifier gain. R3 only sets the loop's DC operating point. Calculate R3's value using the equation shown in Figure 10 (in the appendix):

$$\begin{aligned} \text{where,} \\ R2 &= 15.4 \text{ k}\Omega \\ V_{OUT} &= \text{desired output voltage} \\ V_{FB} &= 1.225V \end{aligned}$$

If the output voltage is raised above 10V be sure and replace output capacitor C2 (220 μ F, 10V) with an appropriately rated device.

Modifying the Switching Frequency

The internal oscillator frequency (switching frequency) of the LM25576 is determined by the value of R7. By default, the reference design is designed to operate at a nominal 300 kHz switching frequency. Change the frequency by calculating a new resistor value using the equation shown in Figure 8 (in the appendix):

$$\begin{aligned} \text{where,} \\ f &= \text{switching frequency in hertz} \end{aligned}$$

Changing the switching frequency of the demonstration board will affect performance of the board. Recalculate inductor L1 and capacitor C2, after the new frequency is determined. Refer to the LM25576 datasheet for equations relating to inductor and capacitor calculations.

10.0 Layouts

Soft-Start

The soft-start feature of the LM25576 gradually ramps the output voltage of the regulator over a pre-determined amount of time. By default, capacitor C8 configures the LM25576 reference design for a soft-start time of approximately 1.2 ms. Modify the soft-start time, by calculating a new value for capacitor C8 using the following equation shown in Figure 9 (in the appendix):

$$\begin{aligned} \text{where,} \\ t_{SS} &= \text{desired soft-start time} \\ V_{SS} &= 1.225V \end{aligned}$$

On-Board Snubber Circuitry

The LM25576 reference design features place-holders for a snubber circuit. The snubber circuit is used to dampen large transient voltages that may appear across schottky diode D1. Selecting the values for the snubber network is best accomplished through empirical methods. Install the selected components at locations R1 and C1 if desired.

Shutdown Control

The LM25576 features a tri-level shutdown input. Control the shutdown feature by driving the SD pad of the LM25576 reference design with an external voltage source. Refer to Table 2 for a description of the voltage input.

Table 2. Shutdown Control

Vmin	Vmax	DESCRIPTION
0	0.7	Shutdown
0.7	1.225	Standby
1.255	8.0	Standard Operating Mode

Additionally, resistors R5 and R6 can be set to enable the LM25576 at a predetermined input voltage (V_{IN}) level. Calculate the resistor values using the equation shown in Figure 11 (in the appendix):

$$\begin{aligned} \text{Where,} \\ R6 &= 100 \text{ k}\Omega \\ V_{IN} &= \text{minimum input voltage} \\ V_{SD} &= 1.225V \end{aligned}$$

Change the design to use the LM5576

The LM25576 reference design can also demonstrate the LM5576 (6V-70V input voltage). When using the LM5576, remove the LM25576 (U1) and replace it with a LM5576MH. Order a free sample of the LM5576MH through online samples at www.national.com.

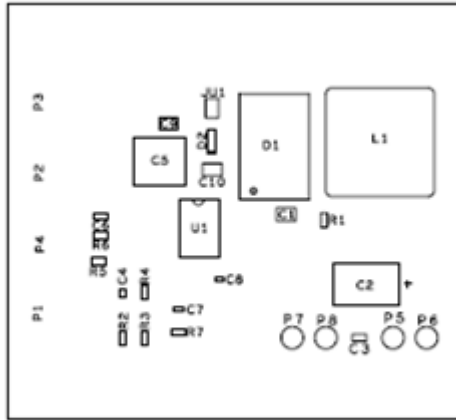

layout

FIGURE 3. LM25576 Reference Board Component Placement Guide Component Side (551013079-001)

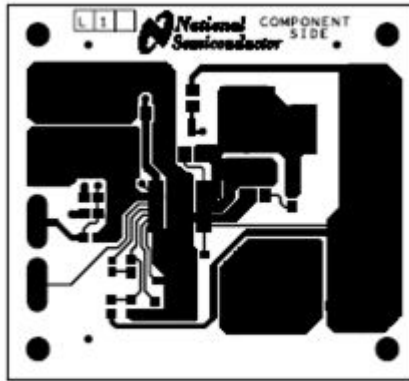

layout1

FIGURE 4. LM25576 Reference Board PC Board Layout Component Side (551013079-001)

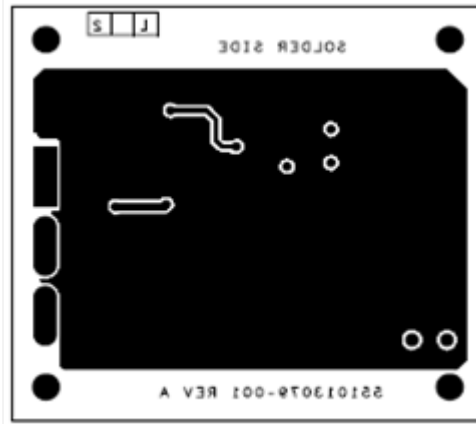

layout2

FIGURE 5. LM25576 Reference Board PC Board Layout Solder Side (551013079-001)

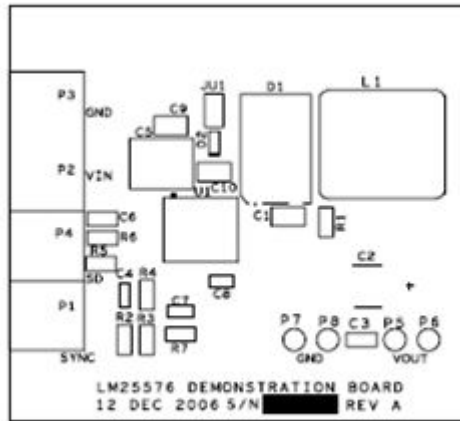

layout3

FIGURE 6. LM25576 Reference Board PC Silkscreen Component Side (551013079-001)

$$R5 = \frac{(V_{IN} - V_{SD}) \times R6}{V_{SD} - R6 \times 5\mu A}$$

image3

FIGURE 10. R5 Equation

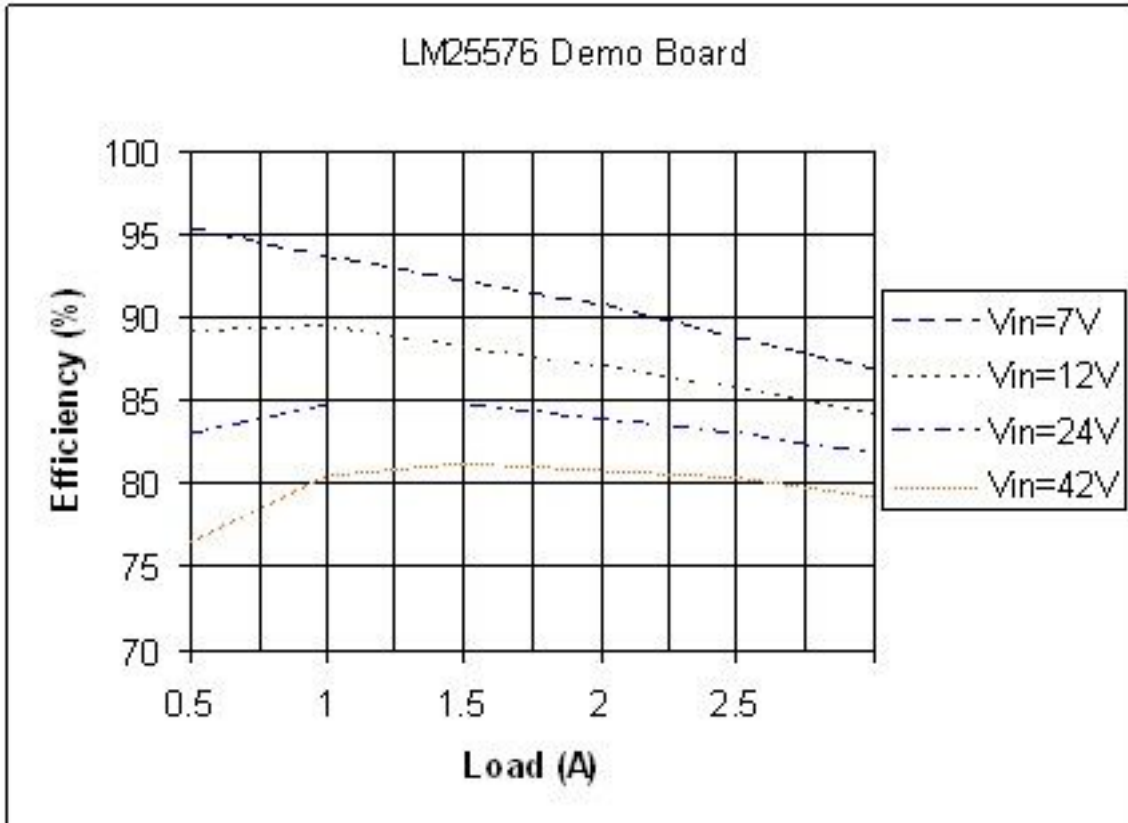

image

FIGURE 11. Efficiency Measurements

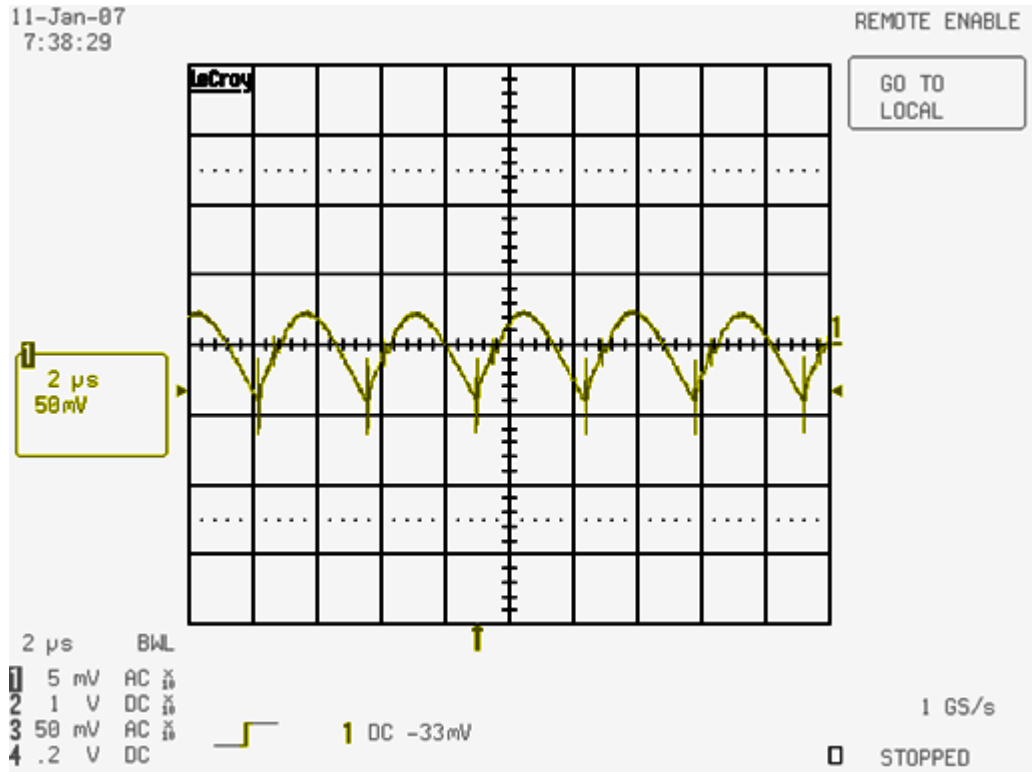

image5

FIGURE 12. Output Ripple - Vin 42V, Iout 3A (Vout 50 mV/Div)

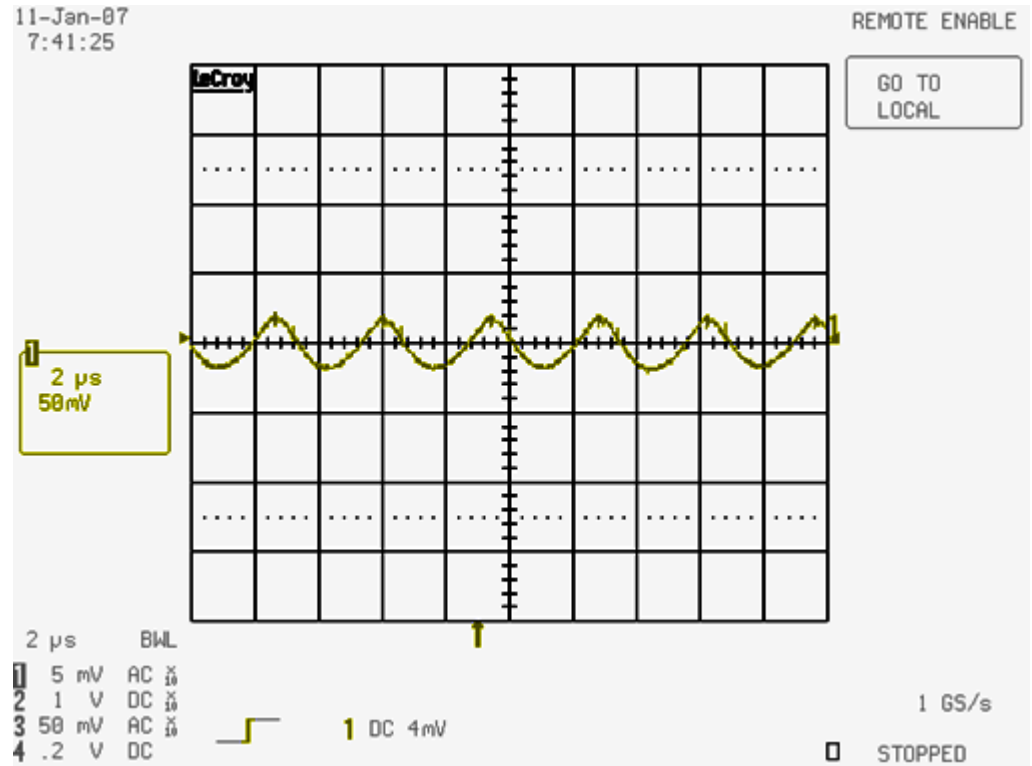

image6

FIGURE 13. Output Ripple - Vin 7V, Iout 3A (Vout 50 mV/Div)

11-Jan-07
7:50:58

REMOTE ENABLE

1
2
1 μ s
10.0 V

GO TO LOCAL

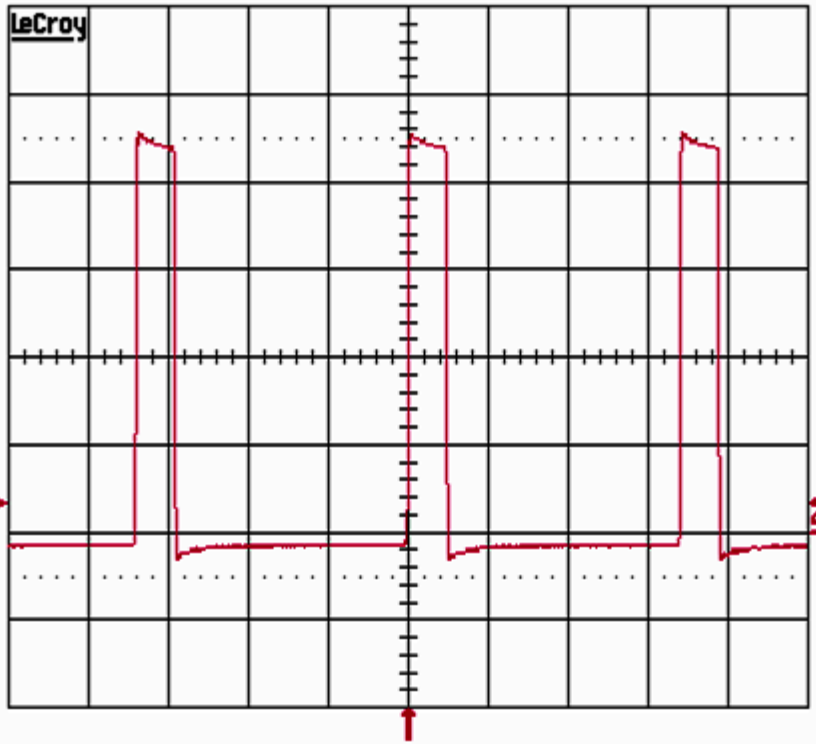

1 μ s BWL
1 .1 V DC X
2 1 V DC X
3 50 mV AC X
4 .2 V DC



2 DC 3.4 V

1 GS/s

STOPPED

image7

FIGURE 14. Switch Node Voltage $V_{in} = 42V$

12-Jan-07
7:50:28

TRIGGER SETUP

4
.5 ms
1.00 A

2
.5 ms
50mV

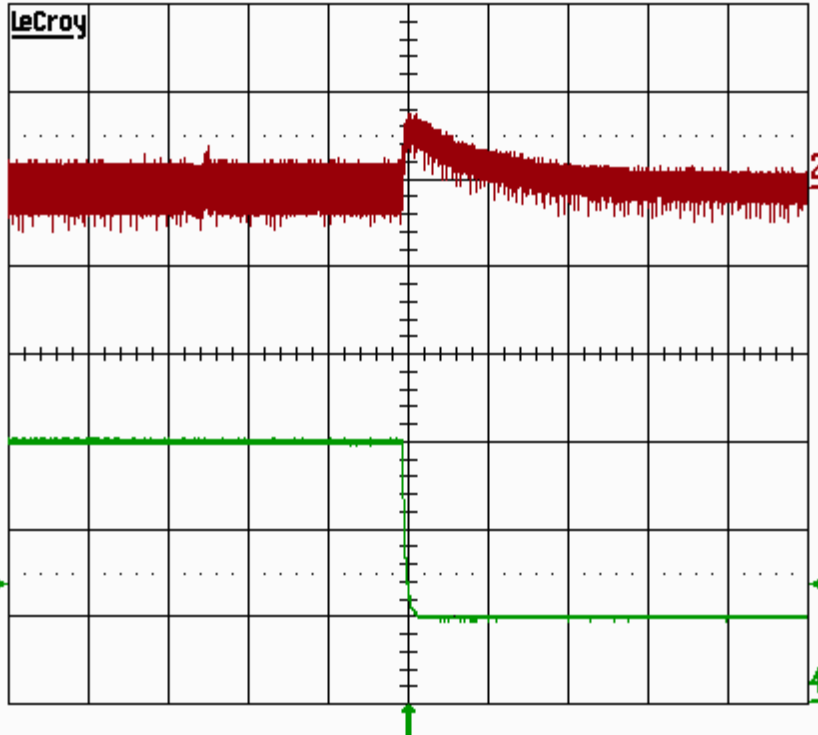

Edge SMART

trigger on
1 2 3 4 Ext
Ext10 Line

coupling 4
DC AC LFREJ
HFREJ HF

slope 4
Pos Neg
Window

holdoff
- - -
OFF Time Evts

.5 ms BWL

1	5 mV	AC	X
2	5 mV	AC	X
3	50 mV	AC	X
4	.1 V	DC	X

4 DC 1.34 A

20 MS/s

STOPPED

image8

FIGURE 15. Transient Response, Vin = 12V, ΔI = 1A to 3A Load On

12-Jan-07
7:51:45

TRIGGER SETUP

Edge SMART

1
.5 ms
1.00 A

2
.5 ms
50mV

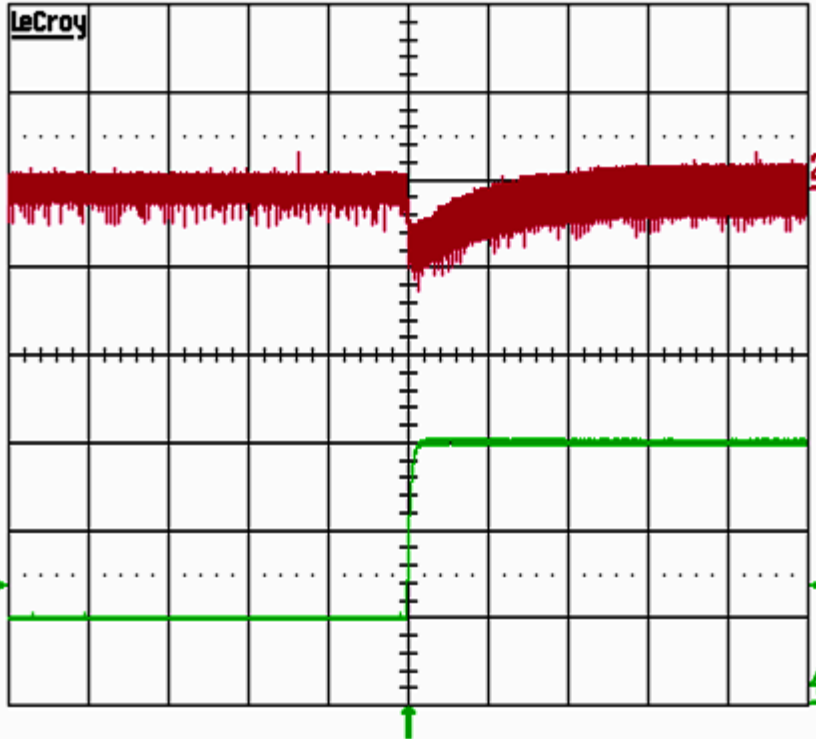

trigger on
1 2 3 4 Ext
Ext10 Line

coupling 4
DC AC LFREJ
HFREJ HF

slope 4
Pos Neg
Window

holdoff
- - -
OFF Time Evt

.5 ms BWL

- 1 5 mV AC X 10
- 2 5 mV AC X 10
- 3 50 mV AC X 10
- 4 .1 V DC X 10



4 DC 1.34 A

20 MS/s

STOPPED

image9

FIGURE 16. Transient Response, Vin = 12V, ΔI = 1A to 3A Load Off

Notes

National Semiconductor's design tools attempt to recreate the performance of a substantially equivalent physical implementation of the design. Reference designs are created using National's published specifications as well as the published specifications of other device manufacturers. While National does update this information periodically, this information may not be current at the time the reference design is built. National and/or its licensors do not warrant the accuracy or completeness of the specifications or any information contained therein. National and/or its licensors do not warrant that any designs or recommended parts will meet the specifications you entered, will be suitable for your application or fit for any particular purpose, or will operate as shown in the simulation in a physical implementation. National and/or its licensors do not warrant that the designs are production worthy. You should completely validate and test your design implementation to confirm the system functionality for your application.

National does not assume any responsibility for use of any circuitry described, no circuit patent licenses are implied and National reserves the right at any time without notice to change said circuitry and specifications.

For the most current product information visit us at www.national.com.

LIFE SUPPORT POLICY

NATIONAL'S PRODUCTS ARE NOT AUTHORIZED FOR USE AS CRITICAL COMPONENTS IN LIFE SUPPORT DEVICES OR SYSTEMS WITHOUT THE EXPRESS WRITTEN APPROVAL OF THE PRESIDENT AND GENERAL COUNSEL OF NATIONAL SEMICONDUCTOR CORPORATION. As used herein:

- Life support devices or systems are devices or systems which,
 - are intended for surgical implant into the body, or
 - support or sustain life, and whose failure to perform when properly used in accordance with instructions for use provided in the labeling, can be reasonably expected to result in a significant injury to the user.
- A critical component is any component of a life support device or system whose failure to perform can be reasonably expected to cause the failure of the life support device or system, or to affect its safety or effectiveness.

BANNED SUBSTANCE COMPLIANCE

National Semiconductor certifies that the products and packing materials meet the provisions of the Customer Products Stewardship Specification (CSP-9-111C2) and the Banned Substances and Materials of Interest Specification (CSP-9-111S2) and contain no "Banned Substances" as defined in CSP-9-111S2.

Leadfree products are RoHS compliant.



National Semiconductor Americas Customer Support Center
 Email: new.feedback@nsc.com
 Tel: 1-800-272-9959

National Semiconductor Europe Customer Support Center
 Fax: +49 (0) 180-530-85-86
 Email: europe.support@nsc.com
 Deutsch Tel: +49 (0) 69 9508 6208
 English Tel: +49 (0) 870 24 0 2171
 Français Tel: +33 (0) 1 41 91 8790

National Semiconductor Asia Pacific Customer Support Center
 Email: ap.support@nsc.com

National Semiconductor Japan Customer Support Center
 Fax: 81-3-5639-7507
 Email: jpn.feedback@nsc.com
 Tel: 81-3-5639-7560

IMPORTANT NOTICE

Texas Instruments Incorporated and its subsidiaries (TI) reserve the right to make corrections, modifications, enhancements, improvements, and other changes to its products and services at any time and to discontinue any product or service without notice. Customers should obtain the latest relevant information before placing orders and should verify that such information is current and complete. All products are sold subject to TI's terms and conditions of sale supplied at the time of order acknowledgment.

TI warrants performance of its hardware products to the specifications applicable at the time of sale in accordance with TI's standard warranty. Testing and other quality control techniques are used to the extent TI deems necessary to support this warranty. Except where mandated by government requirements, testing of all parameters of each product is not necessarily performed.

TI assumes no liability for applications assistance or customer product design. Customers are responsible for their products and applications using TI components. To minimize the risks associated with customer products and applications, customers should provide adequate design and operating safeguards.

TI does not warrant or represent that any license, either express or implied, is granted under any TI patent right, copyright, mask work right, or other TI intellectual property right relating to any combination, machine, or process in which TI products or services are used. Information published by TI regarding third-party products or services does not constitute a license from TI to use such products or services or a warranty or endorsement thereof. Use of such information may require a license from a third party under the patents or other intellectual property of the third party, or a license from TI under the patents or other intellectual property of TI.

Reproduction of TI information in TI data books or data sheets is permissible only if reproduction is without alteration and is accompanied by all associated warranties, conditions, limitations, and notices. Reproduction of this information with alteration is an unfair and deceptive business practice. TI is not responsible or liable for such altered documentation. Information of third parties may be subject to additional restrictions.

Resale of TI products or services with statements different from or beyond the parameters stated by TI for that product or service voids all express and any implied warranties for the associated TI product or service and is an unfair and deceptive business practice. TI is not responsible or liable for any such statements.

TI products are not authorized for use in safety-critical applications (such as life support) where a failure of the TI product would reasonably be expected to cause severe personal injury or death, unless officers of the parties have executed an agreement specifically governing such use. Buyers represent that they have all necessary expertise in the safety and regulatory ramifications of their applications, and acknowledge and agree that they are solely responsible for all legal, regulatory and safety-related requirements concerning their products and any use of TI products in such safety-critical applications, notwithstanding any applications-related information or support that may be provided by TI. Further, Buyers must fully indemnify TI and its representatives against any damages arising out of the use of TI products in such safety-critical applications.

TI products are neither designed nor intended for use in military/aerospace applications or environments unless the TI products are specifically designated by TI as military-grade or "enhanced plastic." Only products designated by TI as military-grade meet military specifications. Buyers acknowledge and agree that any such use of TI products which TI has not designated as military-grade is solely at the Buyer's risk, and that they are solely responsible for compliance with all legal and regulatory requirements in connection with such use.

TI products are neither designed nor intended for use in automotive applications or environments unless the specific TI products are designated by TI as compliant with ISO/TS 16949 requirements. Buyers acknowledge and agree that, if they use any non-designated products in automotive applications, TI will not be responsible for any failure to meet such requirements.

Following are URLs where you can obtain information on other Texas Instruments products and application solutions:

Products

Audio	www.ti.com/audio
Amplifiers	amplifier.ti.com
Data Converters	dataconverter.ti.com
DLP® Products	www.dlp.com
DSP	dsp.ti.com
Clocks and Timers	www.ti.com/clocks
Interface	interface.ti.com
Logic	logic.ti.com
Power Mgmt	power.ti.com
Microcontrollers	microcontroller.ti.com
RFID	www.ti-rfid.com
OMAP Mobile Processors	www.ti.com/omap
Wireless Connectivity	www.ti.com/wirelessconnectivity

Applications

Automotive and Transportation	www.ti.com/automotive
Communications and Telecom	www.ti.com/communications
Computers and Peripherals	www.ti.com/computers
Consumer Electronics	www.ti.com/consumer-apps
Energy and Lighting	www.ti.com/energy
Industrial	www.ti.com/industrial
Medical	www.ti.com/medical
Security	www.ti.com/security
Space, Avionics and Defense	www.ti.com/space-avionics-defense
Video and Imaging	www.ti.com/video

TI E2E Community Home Page

e2e.ti.com

Mailing Address: Texas Instruments, Post Office Box 655303, Dallas, Texas 75265
Copyright © 2012, Texas Instruments Incorporated