

LM2694 30V, 600 mA Step Down Switching Regulator

Check for Samples: [LM2694](#)

FEATURES

- Integrated N-Channel Buck Switch
- Integrated Start-Up Regulator
- Input Voltage Range: 8V to 30V
- No Loop Compensation Required
- Ultra-Fast Transient Response
- Operating Frequency Remains Constant with Load Current and Input Voltage Variations
- Maximum Duty Cycle Limited During Start-Up
- Adjustable Output Voltage
- Valley Current Limit At 0.6A
- Maximum Switching Frequency: 1 MHz
- Precision Internal Reference
- Low Bias Current
- Highly Efficient Operation
- Thermal Shutdown

TYPICAL APPLICATIONS

- High Efficiency Point-Of-Load (POL) Regulator
- Non-Isolated Telecommunication Buck Regulator
- Secondary High Voltage Post Regulator

Basic Step Down Regulator

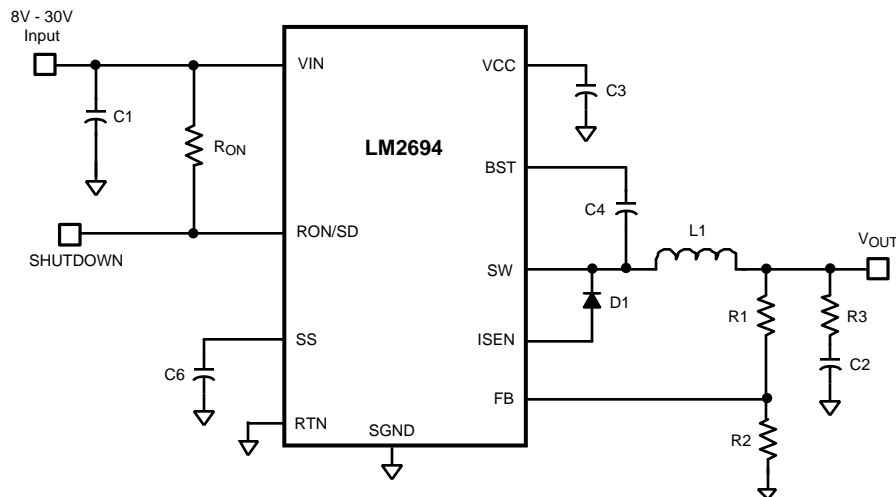

DESCRIPTION

The LM2694 Step Down Switching Regulator features all of the functions needed to implement a low cost, efficient, buck bias regulator capable of supplying 0.6A to the load. This buck regulator contains an N-Channel Buck Switch, and is available in the 3 x 3 thermally enhanced WSON-10 package and a TSSOP-14 package. The feedback regulation scheme requires no loop compensation, results in fast load transient response, and simplifies circuit implementation. The operating frequency remains constant with line and load variations due to the inverse relationship between the input voltage and the on-time. The valley current limit results in a smooth transition from constant voltage to constant current mode when current limit is detected, reducing the frequency and output voltage, without the use of foldback. Additional features include: VCC under-voltage lockout, thermal shutdown, gate drive under-voltage lockout, and maximum duty cycle limiter.

Package

- WSON-10 (3 mm x 3 mm) w/Exposed Pad
- TSSOP-14



Please be aware that an important notice concerning availability, standard warranty, and use in critical applications of Texas Instruments semiconductor products and disclaimers thereto appears at the end of this data sheet.

All trademarks are the property of their respective owners.

Connection Diagrams

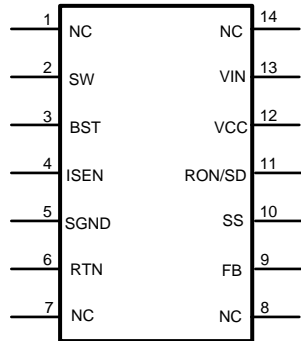

Figure 1. 14-Lead TSSOP Package
See Package Number PW0014A

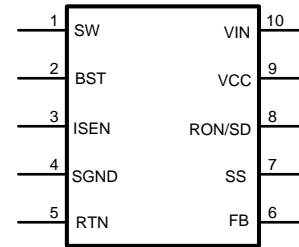

Figure 2. 10-Lead WSON Package
See Package Number DSC0010A

Pin Descriptions

PIN NUMBER		NAME	DESCRIPTION	APPLICATION INFORMATION
WSON-10	TSSOP-14			
1	2	SW	Switching Node	Internally connected to the buck switch source. Connect to the inductor, free-wheeling diode, and bootstrap capacitor.
2	3	BST	Boost pin for bootstrap capacitor	Connect a 0.022 μ F capacitor from SW to the BST pin. The capacitor is charged from VCC via an internal diode during the buck switch off-time.
3	4	ISEN	Current sense	During the buck switch off-time, the inductor current flows through the internal sense resistor, and out of the ISEN pin to the free-wheeling diode. The current limit is nominally set at 0.62A.
4	5	SGND	Current Sense Ground	Re-circulating current flows into this pin to the current sense resistor.
5	6	RTN	Circuit Ground	Ground return for all internal circuitry other than the current sense resistor.
6	9	FB	Voltage feedback input from the regulated output	Input to both the regulation and over-voltage comparators. The FB pin regulation level is 2.5V.
7	10	SS	Softstart	An internal current source charges the SS pin capacitor to 2.5V to soft-start the reference input of the regulation comparator.
8	11	RON/SD	On-time control and shutdown	An external resistor from VIN to the RON/SD pin sets the buck switch on-time. Grounding this pin shuts down the regulator.
9	12	VCC	Output of the startup regulator	The voltage at VCC is nominally regulated at 7V. Connect a 0.1 μ F, or larger capacitor from VCC to ground, as close as possible to the pins. An external voltage can be applied to this pin to reduce internal dissipation. MOSFET body diodes clamp VCC to VIN if $V_{CC} > V_{IN}$.
10	13	VIN	Input supply voltage	Nominal input range is 8V to 30V. Input bypass capacitors should be located as close as possible to the VIN pin and RTN pins.
	1,7,8,14	NC	No connection.	No internal connection. Can be connected to ground plane to improve heat dissipation.
EP		EP	Exposed Pad	Exposed metal pad on the underside of the WSON package. It is recommended to connect this pad to the PC board ground plane to aid in heat dissipation.



These devices have limited built-in ESD protection. The leads should be shorted together or the device placed in conductive foam during storage or handling to prevent electrostatic damage to the MOS gates.

Absolute Maximum Ratings⁽¹⁾⁽²⁾⁽³⁾

VIN to RTN		33V
BST to RTN		47V
SW to RTN (Steady State)		-1.5V
ESD Rating ⁽⁴⁾	Human Body Model	2kV
BST to VCC		33V
VIN to SW		33V
BST to SW		14V
VCC to RTN		14V
SGND to RTN		-0.3V to +0.3V
SS to RTN		-0.3V to 4V
All Other Inputs to RTN		-0.3 to 7V
Storage Temperature Range		-65°C to +150°C
Junction Temperature		150°C

- (1) Absolute Maximum Ratings are limits beyond which damage to the device may occur. Operating Ratings are conditions under which operation of the device is intended to be functional. For ensured specifications and test conditions, see the Electrical Characteristics.
- (2) If Military/Aerospace specified devices are required, please contact the Texas Instruments Sales Office/Distributors for availability and specifications.
- (3) For detailed information on soldering plastic TSSOP and WSON packages, refer to the Packaging Data Book available from TI.
- (4) The human body model is a 100pF capacitor discharged through a 1.5kΩ resistor into each pin.

Operating Ratings⁽¹⁾

VIN		8.0V to 30V
Junction Temperature		-40°C to + 125°C

- (1) Absolute Maximum Ratings are limits beyond which damage to the device may occur. Operating Ratings are conditions under which operation of the device is intended to be functional. For ensured specifications and test conditions, see the Electrical Characteristics.

Electrical Characteristics

Specifications with standard type are for $T_J = 25^\circ\text{C}$ only; limits in **boldface** type apply over the full Operating Junction Temperature (T_J) range. Minimum and Maximum limits are ensured through test, design, or statistical correlation. Typical values represent the most likely parametric norm at $T_J = 25^\circ\text{C}$, and are provided for reference purposes only. Unless otherwise stated the following conditions apply: $V_{IN} = 24\text{V}$, $R_{ON} = 200\text{k}\Omega$ ⁽¹⁾

Symbol	Parameter	Conditions	Min	Typ	Max	Units
Start-Up Regulator, V_{CC}						
V_{CCReg}	V_{CC} regulated output		6.6	7	7.4	V
	V_{IN} - V_{CC} dropout voltage	$I_{CC} = 0\text{ mA}$, $V_{CC} = UVLO_{VCC} + 250\text{ mV}$		1.3		V
	V_{CC} output impedance	$0\text{ mA} \leq I_{CC} \leq 5\text{ mA}$, $V_{IN} = 8\text{V}$		175		Ω
	V_{CC} current limit ⁽²⁾	$V_{CC} = 0\text{V}$		9		mA
$UVLO_{VCC}$	V_{CC} under-voltage lockout threshold	V_{CC} increasing		5.7		V
	$UVLO_{VCC}$ hysteresis	V_{CC} decreasing		150		mV
	$UVLO_{VCC}$ filter delay	100 mV overdrive		3		μs
	I_{IN} operating current	Non-switching, $FB = 3\text{V}$		0.5	0.8	mA
	I_{IN} shutdown current	$R_{ON}/SD = 0\text{V}$		90	180	μA
Switch Characteristics						
$R_{ds(on)}$	Buck Switch $R_{ds(on)}$	$I_{TEST} = 200\text{ mA}$		0.5	1.0	Ω
$UVLO_{GD}$	Gate Drive UVLO	$V_{BST} - V_{SW}$ Increasing	3.0	4.4	5.5	V
	$UVLO_{GD}$ hysteresis			490		mV
Softstart Pin						
	Pull-up voltage			2.5		V
	Internal current source			12		μA
Current Limit						
I_{LIM}	Threshold	Current out of ISEN	0.5	0.62	0.74	A
	Resistance from ISEN to SGND			180		m Ω
	Response time			150		ns
On Timer						
t_{ON-1}	On-time	$V_{IN} = 10\text{V}$, $R_{ON} = 200\text{ k}\Omega$	2.1	2.8	3.6	μs
t_{ON-2}	On-time	$V_{IN} = 30\text{V}$, $R_{ON} = 200\text{ k}\Omega$		900		ns
	Shutdown threshold	Voltage at R_{ON}/SD rising	0.45	0.8	1.2	V
	Threshold hysteresis	Voltage at R_{ON}/SD falling		35		mV
Off Timer						
t_{OFF}	Minimum Off-time			265		ns
Regulation and Over-Voltage Comparators (FB Pin)						
V_{REF}	FB regulation threshold	SS pin = steady state	2.440	2.5	2.550	V
	FB over-voltage threshold			2.9		V
	FB bias current			1		nA
Thermal Shutdown						
T_{SD}	Thermal shutdown temperature			175		$^\circ\text{C}$
	Thermal shutdown hysteresis			20		$^\circ\text{C}$
Thermal Resistance						
θ_{JA}	Junction to Ambient 0 LFPM Air Flow	WSOP Package		33		$^\circ\text{C}/\text{W}$
		TSSOP Package		40		
θ_{JC}	Junction to Case	WSOP Package		8.8		$^\circ\text{C}/\text{W}$
		TSSOP Package		5.2		

(1) Typical specifications represent the most likely parametric norm at 25°C operation.

(2) V_{CC} provides self bias for the internal gate drive and control circuits. Device thermal limitations limit external loading

Typical Performance Characteristics

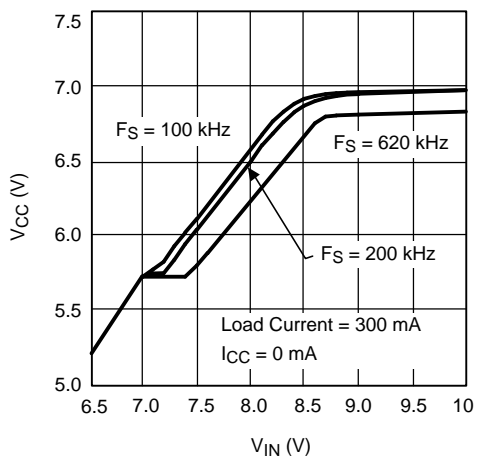

Figure 3. V_{CC} vs V_{IN}

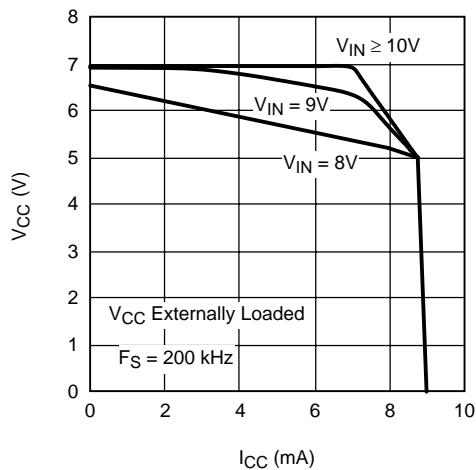

Figure 4. V_{CC} vs I_{CC}

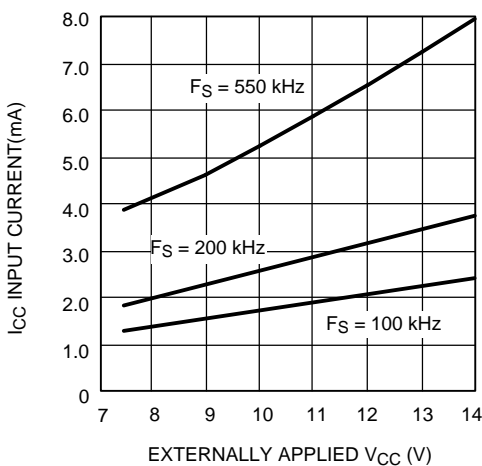

Figure 5. I_{CC} vs Externally Applied V_{CC}

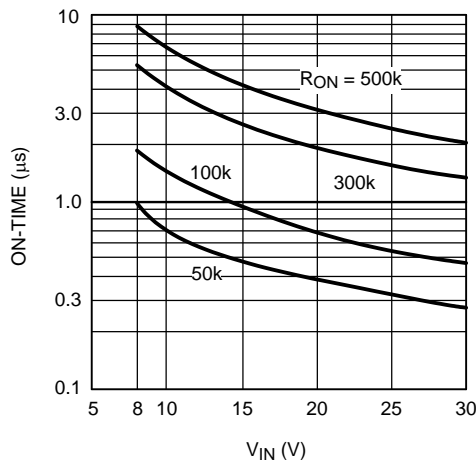

Figure 6. ON-Time vs V_{IN} and R_{ON}

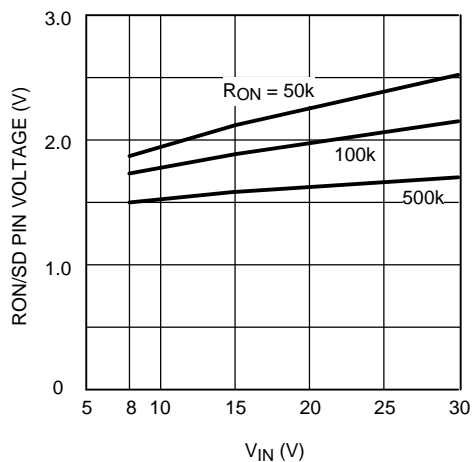

Figure 7. Voltage at R_{ON}/SD Pin

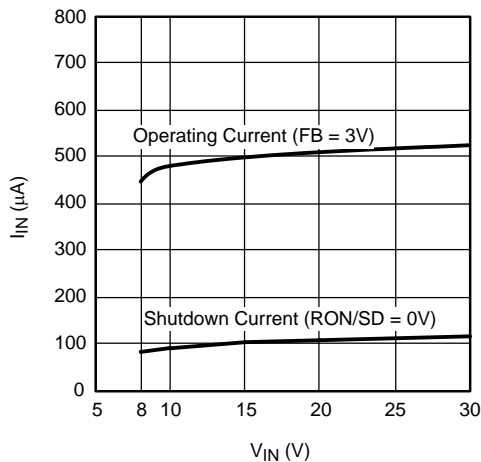
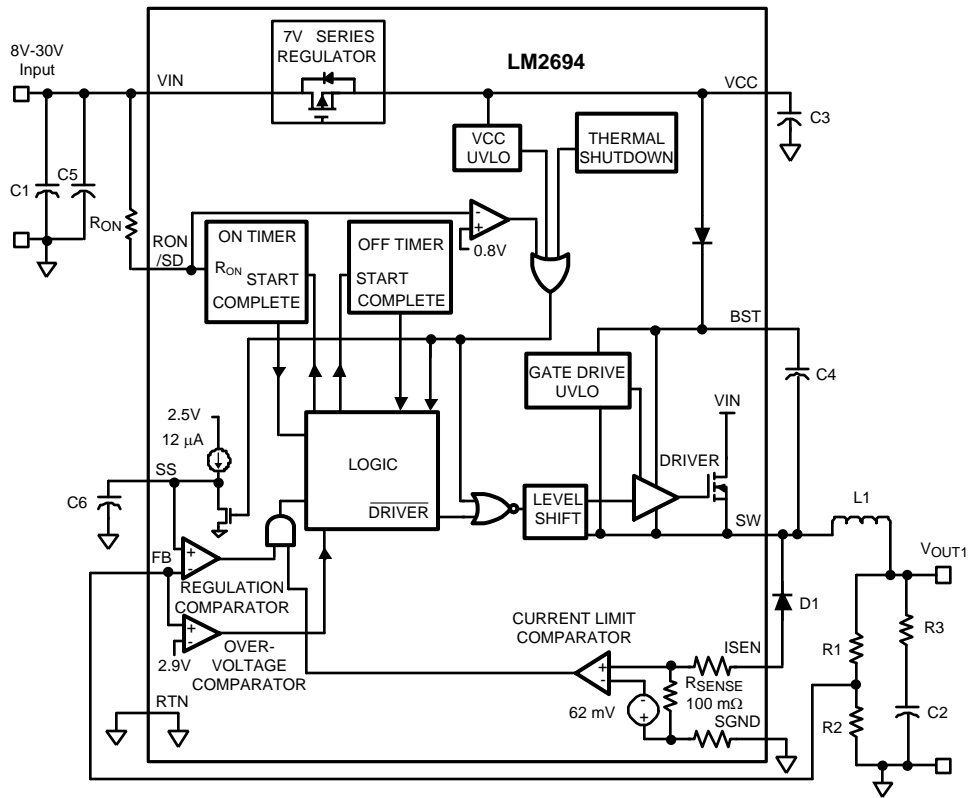

Figure 8. I_{IN} vs V_{IN}

Typical Application Circuit and Block Diagram



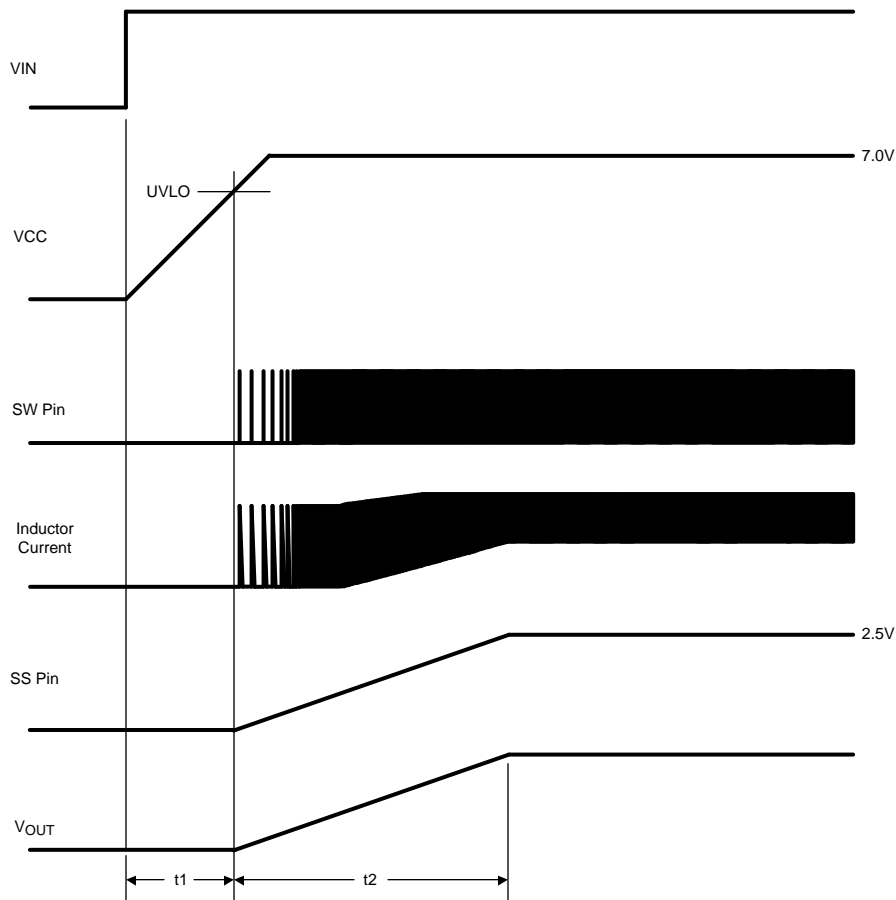

Figure 9. Startup Sequence

Functional Description

The LM2694 Step Down Switching Regulator features all the functions needed to implement a low cost, efficient buck bias power converter capable of supplying at least 0.6A to the load. This high voltage regulator contains a 30V N-Channel buck switch, is easy to implement, and is available in the TSSOP-14 and the thermally enhanced WSON-10 packages. The regulator's operation is based on a constant on-time control scheme, where the on-time is determined by V_{IN} . This feature allows the operating frequency to remain relatively constant with load and input voltage variations. The feedback control requires no loop compensation resulting in very fast load transient response. The valley current limit detection circuit, internally set at 0.62A, holds the buck switch off until the high current level subsides. This scheme protects against excessively high currents if the output is short-circuited when V_{IN} is high. The functional block diagram is shown in [Typical Application Circuit and Block Diagram](#).

The LM2694 can be applied in numerous applications to efficiently regulate down higher voltages. Additional features include: Thermal shutdown, V_{CC} under-voltage lockout, gate drive under-voltage lockout, and maximum duty cycle limiter.

Control Circuit Overview

The LM2694 buck DC-DC regulator employs a control scheme based on a comparator and a one-shot on-timer, with the output voltage feedback (FB) compared to an internal reference (2.5V). If the FB voltage is below the reference the buck switch is turned on for a time period determined by the input voltage and a programming resistor (R_{ON}). Following the on-time the switch remains off for a minimum of 265 ns, and until the FB voltage falls below the reference. The buck switch then turns on for another on-time period. Typically, during start-up, or when the load current increases suddenly, the off-times are at the minimum of 265 ns. Once regulation is established, the off-times are longer.

When in regulation, the LM2694 operates in continuous conduction mode at heavy load currents and discontinuous conduction mode at light load currents. In continuous conduction mode current always flows through the inductor, never reaching zero during the off-time. In this mode the operating frequency remains relatively constant with load and line variations. The minimum load current for continuous conduction mode is one-half the inductor's ripple current amplitude. The operating frequency is approximately:

$$F_S = \frac{V_{OUT} \times (V_{IN} - 1.5V)}{1.14 \times 10^{-10} \times (R_{ON} + 1.4 \text{ k}\Omega) \times V_{IN}} \quad (1)$$

The buck switch duty cycle is equal to:

$$DC = \frac{t_{ON}}{t_{ON} + t_{OFF}} = \frac{V_{OUT}}{V_{IN}} = t_{ON} \times F_S \quad (2)$$

In discontinuous conduction mode current through the inductor ramps up from zero to a peak during the on-time, then ramps back to zero before the end of the off-time. The next on-time period starts when the voltage at FB falls below the reference - until then the inductor current remains zero, and the load current is supplied by the output capacitor (C2). In this mode the operating frequency is lower than in continuous conduction mode, and varies with load current. Conversion efficiency is maintained at light loads since the switching losses reduce with the reduction in load and frequency. The approximate discontinuous operating frequency can be calculated as follows:

$$F_S = \frac{V_{OUT}^2 \times L1 \times 1.54 \times 10^{20}}{R_L \times (R_{ON})^2}$$

where

- R_L = the load resistance (3)

The output voltage is set by two external resistors (R1, R2). The regulated output voltage is calculated as follows:

$$V_{OUT} = 2.5 \times (R1 + R2) / R2 \quad (4)$$

Output voltage regulation is based on ripple voltage at the feedback input, requiring a minimum amount of ESR for the output capacitor C2. The LM2694 requires a minimum of 25 mV of ripple voltage at the FB pin. In cases where the capacitor's ESR is insufficient additional series resistance may be required (R3 in [Typical Application Circuit and Block Diagram](#)).

Start-Up Regulator, V_{CC}

The start-up regulator is integral to the LM2694. The input pin (VIN) can be connected directly to line voltage up to 30V, with transient capability to 33V. The V_{CC} output regulates at 7.0V, and is current limited at 9 mA. Upon power up, the regulator sources current into the external capacitor at VCC (C3). When the voltage on the VCC pin reaches the under-voltage lockout threshold of 5.7V, the buck switch is enabled and the Softstart pin is released to allow the Softstart capacitor (C6) to charge up.

The minimum input voltage is determined by the regulator's dropout voltage, the V_{CC} UVLO falling threshold ($\approx 5.5V$), and the frequency. When V_{CC} falls below the falling threshold the V_{CC} UVLO activates to shut off the output. If V_{CC} is externally loaded, the minimum input voltage increases.

To reduce power dissipation in the start-up regulator, an auxiliary voltage can be diode connected to the V_{CC} pin. Setting the auxiliary voltage to between 8V and 14V shuts off the internal regulator, reducing internal power dissipation. The sum of the auxiliary voltage and the input voltage ($V_{CC} + V_{IN}$) cannot exceed 47V. Internally, a diode connects VCC to VIN. See [Figure 10](#).

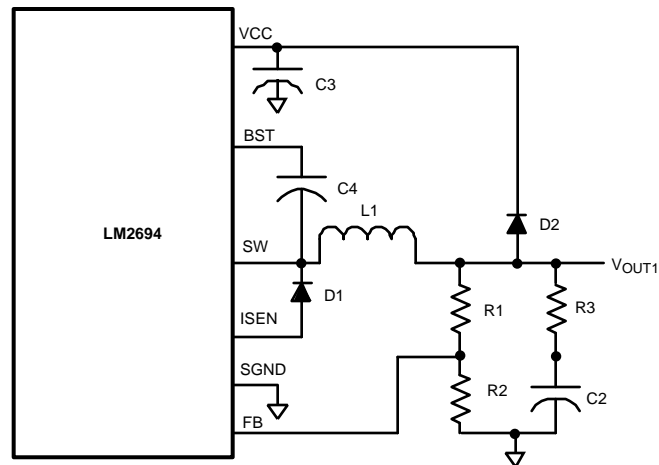

Figure 10. Self Biased Configuration

Regulation Comparator

The feedback voltage at FB is compared to the voltage at the Softstart pin (2.5V). In normal operation (the output voltage is regulated), an on-time period is initiated when the voltage at FB falls below 2.5V. The buck switch stays on for the programmed on-time, causing the FB voltage to rise above 2.5V. After the on-time period, the buck switch stays off until the FB voltage falls below 2.5V. Input bias current at the FB pin is less than 100 nA over temperature.

Over-Voltage Comparator

The voltage at FB is compared to an internal 2.9V reference. If the voltage at FB rises above 2.9V the on-time pulse is immediately terminated. This condition can occur if the input voltage or the output load changes suddenly, or if the inductor (L1) saturates. The buck switch remains off until the voltage at FB falls below 2.5V.

ON-Time Timer, and Shutdown

The on-time for the LM2694 is determined by the R_{ON} resistor and the input voltage (V_{IN}), and is calculated from:

$$t_{ON} = \frac{1.14 \times 10^{-10} \times (R_{ON} + 1.4 \text{ k}\Omega)}{V_{IN} - 1.5V} + 95 \text{ ns} \quad (5)$$

See Figure 6. The inverse relationship with V_{IN} results in a nearly constant frequency as V_{IN} is varied. To set a specific continuous conduction mode switching frequency (F_S), the R_{ON} resistor is determined from the following:

$$R_{ON} = \frac{V_{OUT} \times (V_{IN} - 1.5V)}{F_S \times 1.14 \times 10^{-10} \times V_{IN}} - 1.4 \text{ k}\Omega \quad (6)$$

In high frequency applications the minimum value for t_{ON} is limited by the maximum duty cycle required for regulation and the minimum off-time of 265 ns, $\pm 15\%$. The minimum off-time limits the maximum duty cycle achievable with a low voltage at V_{IN} . The minimum allowed on-time to regulate the desired V_{OUT} at the minimum V_{IN} is determined from the following:

$$t_{ON(\min)} = \frac{V_{OUT} \times 305 \text{ ns}}{(V_{IN(\min)} - V_{OUT})} \quad (7)$$

The LM2694 can be remotely shut down by taking the RON/SD pin below 0.8V. See Figure 11. In this mode the SS pin is internally grounded, the on-timer is disabled, and bias currents are reduced. Releasing the RON/SD pin allows normal operation to resume. The voltage at the RON/SD pin is normally between 1.5V and 3.0V, depending on V_{IN} and the R_{ON} resistor.

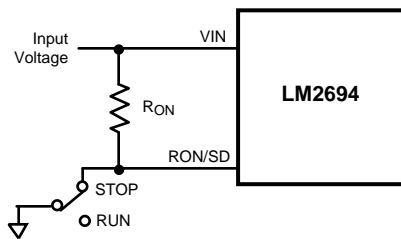

Figure 11. Shutdown Implementation

Current Limit

Current limit detection occurs during the off-time by monitoring the recirculating current through the free-wheeling diode (D1). Referring to [Typical Application Circuit and Block Diagram](#), when the buck switch is turned off the inductor current flows through the load, into SGND, through the sense resistor, out of ISEN and through D1. If that current exceeds 0.62A the current limit comparator output switches to delay the start of the next on-time period if the voltage at FB is below 2.5V. The next on-time starts when the current out of ISEN is below 0.62A and the voltage at FB is below 2.5V. If the overload condition persists causing the inductor current to exceed 0.62A during each on-time, that is detected at the beginning of each off-time. The operating frequency is lower due to longer-than-normal off-times.

[Figure 12](#) illustrates the inductor current waveform. During normal operation the load current is I_o , the average of the ripple waveform. When the load resistance decreases the current ratchets up until the lower peak reaches 0.62A. During the Current Limited portion of [Figure 12](#), the current ramps down to 0.62A during each off-time, initiating the next on-time (assuming the voltage at FB is $<2.5V$). During each on-time the current ramps up an amount equal to:

$$\Delta I = (V_{IN} - V_{OUT}) \times t_{ON} / L1 \quad (8)$$

During this time the LM2694 is in a constant current mode, with an average load current (I_{OCL}) equal to $0.62A + \Delta I/2$.

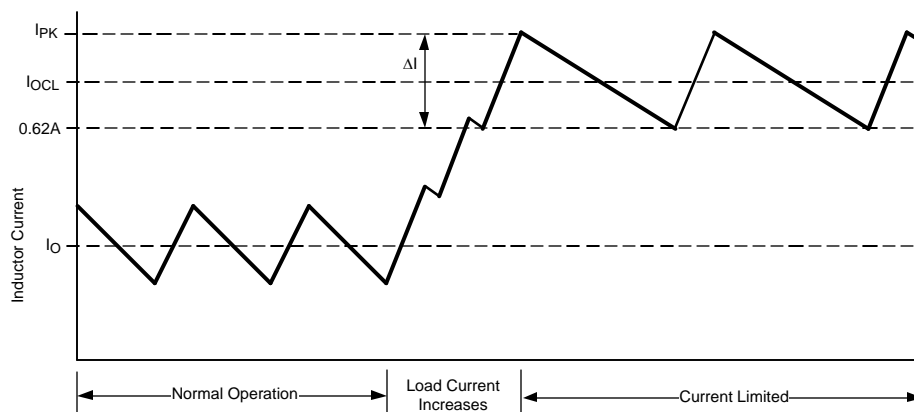

Figure 12. Inductor Current - Current Limit Operation

N - Channel Buck Switch and Driver

The LM2694 integrates an N-Channel buck switch and associated floating high voltage gate driver. The peak current allowed through the buck switch is 1.5A, and the maximum allowed average current is 1A. The gate driver circuit works in conjunction with an external bootstrap capacitor and an internal high voltage diode. A 0.022 μF capacitor (C4) connected between BST and SW provides the voltage to the driver during the on-time. During each off-time, the SW pin is at approximately -1V, and C4 charges from V_{CC} through the internal diode. The minimum off-time of 265 ns ensures a minimum time each cycle to recharge the bootstrap capacitor.

Softstart

The softstart feature allows the converter to gradually reach a steady state operating point, thereby reducing start-up stresses and current surges. Upon turn-on, after V_{CC} reaches the under-voltage threshold, an internal 12 μ A current source charges up the external capacitor at the SS pin to 2.5V. The ramping voltage at SS (and the non-inverting input of the regulation comparator) ramps up the output voltage in a controlled manner.

An internal switch grounds the SS pin if V_{CC} is below the under-voltage lockout threshold, if a thermal shutdown occurs, or if the RON/SD pin is grounded.

Thermal Shutdown

The LM2694 should be operated so the junction temperature does not exceed 125°C. If the junction temperature increases, an internal Thermal Shutdown circuit, which activates (typically) at 175°C, takes the controller to a low power reset state by disabling the buck switch and the on-timer, and grounding the Softstart pin. This feature helps prevent catastrophic failures from accidental device overheating. When the junction temperature reduces below 155°C (typical hysteresis = 20°C), the Softstart pin is released and normal operation resumes.

APPLICATIONS INFORMATION

EXTERNAL COMPONENTS

The procedure for calculating the external components is illustrated with a design example. Referring to the [Block Diagram](#), the circuit is to be configured for the following specifications:

- $V_{OUT} = 5V$
- $V_{IN} = 8V$ to 30V
- $F_S = 250$ kHz
- Minimum load current = 100 mA
- Maximum load current = 600 mA
- Softstart time = 5 ms.

R1 and R2: These resistors set the output voltage, and their ratio is calculated from:

$$R1/R2 = (V_{OUT}/2.5V) - 1 \quad (9)$$

R1/R2 calculates to 1.0. The resistors should be chosen from standard value resistors in the range of 1.0 k Ω - 10 k Ω . A value of 2.5 k Ω will be used for R1 and for R2.

R_{ON}, F_S: R_{ON} can be chosen using [Equation 6](#) to set the nominal frequency, or from [Equation 5](#) if the on-time at a particular V_{IN} is important. A higher frequency generally means a smaller inductor and capacitors (value, size and cost), but higher switching losses. A lower frequency means a higher efficiency, but with larger components. Generally, if PC board space is tight, a higher frequency is better. The resulting on-time and frequency have a $\pm 25\%$ tolerance. Using [Equation 6](#) at a V_{IN} of 8V,

$$R_{ON} = \frac{5V \times (8V - 1.5V)}{8V \times 250 \text{ kHz} \times 1.14 \times 10^{-10}} - 1.4 \text{ k}\Omega = 141 \text{ k}\Omega \quad (10)$$

A value of 140 k Ω will be used for R_{ON}, yielding a nominal frequency of 252 kHz.

L1: The guideline for choosing the inductor value in this example is that it must keep the circuit's operation in continuous conduction mode at minimum load current. This is not a strict requirement since the LM2694 regulates correctly when in discontinuous conduction mode, although at a lower frequency. However, to provide an initial value for L1 the above guideline will be used.

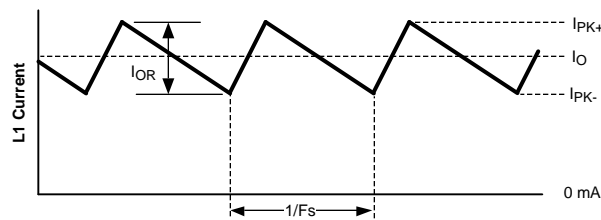

Figure 13. Inductor Current

To keep the circuit in continuous conduction mode, the maximum allowed ripple current is twice the minimum load current, or 200 mAp-p. Using this value of ripple current, the inductor (L1) is calculated using the following:

$$L1 = \frac{V_{OUT} \times (V_{IN(max)} - V_{OUT})}{I_{OR} \times F_{S(min)} \times V_{IN(max)}}$$

where

- $F_{S(min)}$ is the minimum frequency of 189 kHz (252 kHz - 25%) (11)

$$L1 = \frac{5V \times (30V - 5V)}{0.2A \times 189 \text{ kHz} \times 30V} = 110 \mu\text{H} \quad (12)$$

This provides a minimum value for L1 - the next higher standard value (150 μH) will be used. To prevent saturation, and possible destructive current levels, L1 must be rated for the peak current which occurs if the current limit and maximum ripple current are reached simultaneously. The maximum ripple amplitude is calculated by re-arranging Equation 11 using $V_{IN(max)}$, $F_{S(min)}$, and the minimum inductor value, based on the manufacturer's tolerance. Assume, for this exercise, the inductor's tolerance is $\pm 20\%$.

$$I_{OR(max)} = \frac{V_{OUT} \times (V_{IN(max)} - V_{OUT})}{L1_{MIN} \times F_{S(min)} \times V_{IN(max)}} \quad (13)$$

$$I_{OR(max)} = \frac{5V \times (30V - 5V)}{120 \mu\text{H} \times 189 \text{ kHz} \times 30V} = 184 \text{ mAp-p} \quad (14)$$

$$I_{PK} = I_{LIM} + I_{OR(max)} = 0.74A + 0.18A = 0.92A$$

where

- I_{LIM} is the maximum specified current limit threshold (15)

At the nominal maximum load current of 0.6A, the peak inductor current is 692 mA.

C1: This capacitor limits the ripple voltage at VIN resulting from the source impedance of the supply feeding this circuit, and the on/off nature of the switch current into VIN. At maximum load current, when the buck switch turns on, the current into VIN steps up from zero to the lower peak of the inductor current waveform (I_{PK} in Figure 13), ramps up to the peak value (I_{PK+}), then drops to zero at turn-off. The average current into VIN during this on-time is the load current. For a worst case calculation, C1 must supply this average current during the maximum on-time. The maximum on-time is calculated at $V_{IN} = 8V$ using Equation 5, with a 25% tolerance added:

$$t_{ON(max)} = \left[\frac{1.14 \times 10^{-10} \times (140k + 1.4k)}{8V - 1.5V} + 95 \text{ ns} \right] \times 1.25 = 3.22 \mu\text{s} \quad (16)$$

The voltage at VIN should not be allowed to drop below 7.5V in order to maintain V_{CC} above its UVLO.

$$C1 = \frac{I_O \times t_{ON}}{\Delta V} = \frac{0.6A \times 3.22 \mu\text{s}}{0.5V} = 3.8 \mu\text{F} \quad (17)$$

Normally a lower value can be used for C1 since the above calculation is a worst case calculation which assumes the power source has a high source impedance. A quality ceramic capacitor with a low ESR should be used for C1.

C2 and R3: Since the LM2694 requires a minimum of 25 mVp-p of ripple at the FB pin for proper operation, the required ripple at V_{OUT} is increased by R1 and R2, and is equal to:

$$V_{RIPPLE} = 25 \text{ mVp-p} \times (R1 + R2)/R2 = 50 \text{ mVp-p} \quad (18)$$

This necessary ripple voltage is created by the inductor ripple current acting on C2's ESR + R3. First, the minimum ripple current, which occurs at minimum V_{IN} , maximum inductor value, and maximum frequency, is determined.

$$\begin{aligned} I_{OR(\min)} &= \frac{V_{OUT} \times (V_{IN(\min)} - V_{OUT})}{L1_{\max} \times F_{S(\max)} \times V_{IN(\min)}} \\ &= \frac{5V \times (8V - 5V)}{180 \mu\text{H} \times 315 \text{ kHz} \times 8V} = 33 \text{ mA p-p} \end{aligned} \quad (19)$$

The minimum ESR for C2 is then equal to:

$$ESR_{(\min)} = \frac{50 \text{ mV}}{33 \text{ mA}} = 1.5\Omega \quad (20)$$

If the capacitor used for C2 does not have sufficient ESR, R3 is added in series as shown in [Typical Application Circuit and Block Diagram](#). The value chosen for C2 is application dependent, and it is recommended that it be no smaller than 3.3 μF . C2 affects the ripple at V_{OUT} , and transient response. Experimentation is usually necessary to determine the optimum value for C2.

C3: The capacitor at the VCC pin provides noise filtering and stability, prevents false triggering of the V_{CC} UVLO at the buck switch on/off transitions, and limits the peak voltage at V_{CC} when a high voltage with a short rise time is initially applied at V_{IN} . C3 should be no smaller than 0.1 μF , and should be a good quality, low ESR, ceramic capacitor, physically close to the IC pins.

C4: The recommended value for C4 is 0.022 μF . A high quality ceramic capacitor with low ESR is recommended as C4 supplies the surge current to charge the buck switch gate at each turn-on. A low ESR also ensures a complete recharge during each off-time.

C5: This capacitor suppresses transients and ringing due to lead inductance at V_{IN} . A low ESR, 0.1 μF ceramic chip capacitor is recommended, located physically close to the LM2694.

C6: The capacitor at the SS pin determines the soft-start time, i.e. the time for the reference voltage at the regulation comparator, and the output voltage, to reach their final value. The capacitor value is determined from the following:

$$C6 = \frac{t_{SS} \times 12 \mu\text{A}}{2.5V} \quad (21)$$

For a 5 ms softstart time, C6 calculates to 0.024 μF .

D1: A Schottky diode is recommended. Ultra-fast recovery diodes are not recommended as the high speed transitions at the SW pin may inadvertently affect the IC's operation through external or internal EMI. The diode should be rated for the maximum V_{IN} (30V), the maximum load current (0.6A), and the peak current which occurs when current limit and maximum ripple current are reached simultaneously (I_{PK} in [Figure 12](#)), previously calculated to be 0.92A. The diode's forward voltage drop affects efficiency due to the power dissipated during the off-time. The average power dissipation in D1 is calculated from:

$$P_{D1} = V_F \times I_O \times (1 - D)$$

where

- I_O is the load current, and D is the duty cycle (22)

FINAL CIRCUIT

The final circuit is shown in [Figure 14](#), and its performance is shown in [Figure 15](#) and [Figure 16](#). Current limit measured approximately 0.64A.

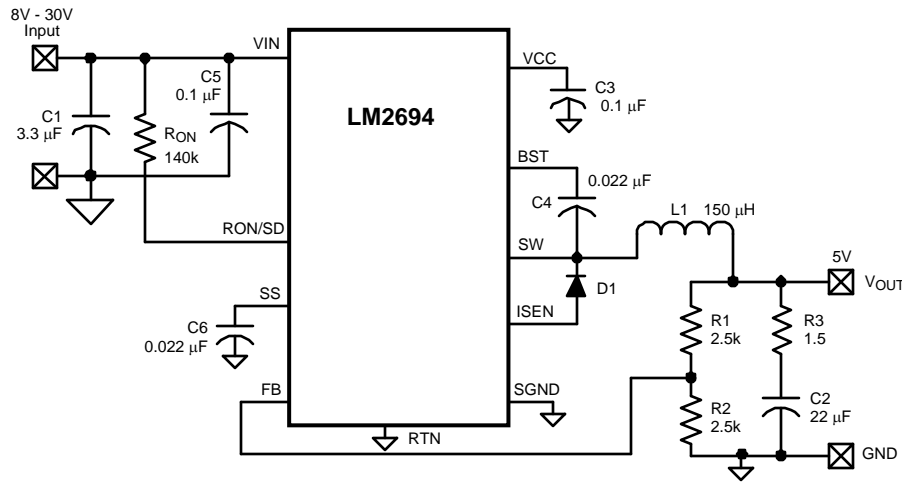

Figure 14. Example Circuit

Item	Description	Value
C1	Ceramic Capacitor	3.3 μ F, 50V
C2	Ceramic Capacitor	22 μ F, 16V
C4, C6	Ceramic Capacitor	0.022 μ F, 16V
C3, C5	Ceramic Capacitor	0.1 μ F, 50V
D1	Schottky Diode	60V, 1A
L1	Inductor	150 μ H
R1	Resistor	2.5 k Ω
R2	Resistor	2.5 k Ω
R3	Resistor	1.5 Ω
R _{ON}	Resistor	140 k Ω
U1	T1 Semi LM2694	

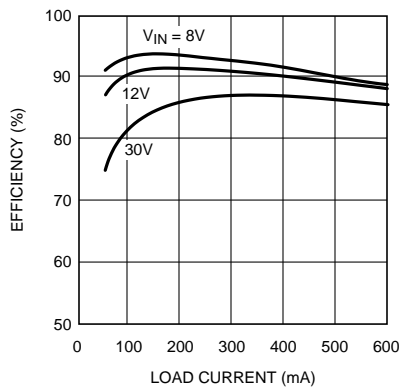

Figure 15. Efficiency vs Load Current and V_{IN}
Circuit of [Figure 14](#)

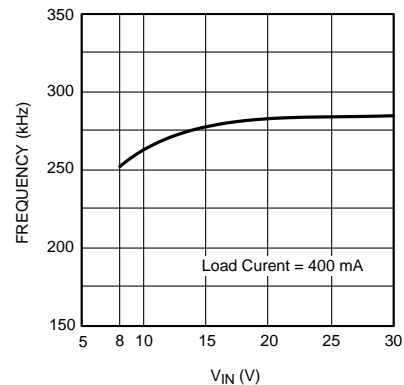

Figure 16. Frequency vs V_{IN}
Circuit of [Figure 14](#)

MINIMUM LOAD CURRENT

The LM2694 requires a minimum load current of 500 μ A. If the load current falls below that level, the bootstrap capacitor (C4) may discharge during the long off-time, and the circuit will either shutdown, or cycle on and off at a low frequency. If the load current is expected to drop below 500 μ A in the application, R1 and R2 should be chosen low enough in value so they provide the minimum required current at nominal V_{OUT} .

LOW OUTPUT RIPPLE CONFIGURATIONS

For applications where low output voltage ripple is required the output can be taken directly from the low ESR output capacitor (C2) as shown in Figure 17. However, R3 slightly degrades the load regulation. The specific component values, and the application determine if this is suitable.

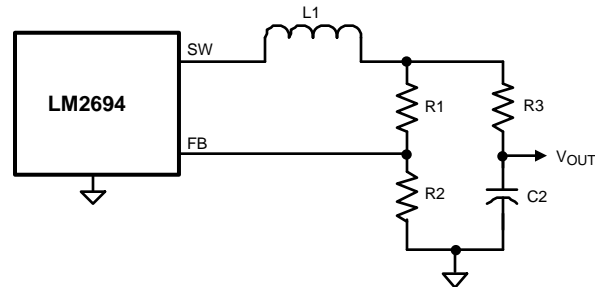

Figure 17. Low Ripple Output

Where the circuit of Figure 17 is not suitable for reducing output ripple, the circuits of Figure 18 or Figure 19 can be used.

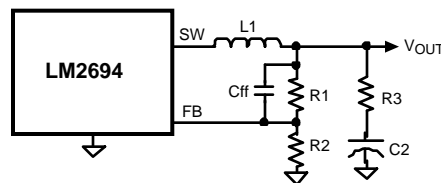

Figure 18. Low Output Ripple Using a Feedforward Capacitor

In Figure 18, Cff is added across R1 to AC-couple the ripple at V_{OUT} directly to the FB pin. This allows the ripple at V_{OUT} to be reduced, in some cases considerably, by reducing R3. In the circuit of Figure 14, the ripple at V_{OUT} ranged from 50 mVp-p at $V_{IN} = 8$ V to 100 mVp-p at $V_{IN} = 30$ V. By adding a 2700 pF capacitor at Cff and reducing R3 to 0.75 Ω , the V_{OUT} ripple is reduced by 50%.

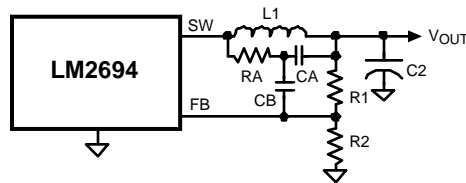

Figure 19. Minimum Output Ripple Using Ripple Injection

To reduce V_{OUT} ripple further, the circuit of Figure 19 can be used. R3 has been removed, and the output ripple amplitude is determined by C2's ESR and the inductor ripple current. RA and CA are chosen to generate a 40-50 mVp-p sawtooth at their junction, and that voltage is AC-coupled to the FB pin via CB. In selecting RA and CA, V_{OUT} is considered a virtual ground as the SW pin switches between V_{IN} and -1V. Since the on-time at SW varies inversely with V_{IN} , the waveform amplitude at the RA/CA junction is relatively constant. Typical values for the additional components are RA = 110k, CA = 2700 pF, and CB = 0.01 μ F.

PC BOARD LAYOUT and THERMAL CONSIDERATIONS

The LM2694 regulation, over-voltage, and current limit comparators are very fast, and will respond to short duration noise pulses. Layout considerations are therefore critical for optimum performance. The layout must be as neat and compact as possible, and all the components must be as close as possible to their associated pins. The two major current loops have currents which switch very fast, and so the loops should be as small as possible to minimize conducted and radiated EMI. The first loop is that formed by C1, through the VIN to SW pins, L1, C2, and back to C1. The second loop is that formed by D1, L1, C2, and the SGND and ISEN pins. The ground connection from C2 to C1 should be as short and direct as possible, preferably without going through vias. Directly connect the SGND and RTN pin to each other, and they should be connected as directly as possible to the C1/C2 ground line without going through vias. The power dissipation within the IC can be approximated by determining the total conversion loss ($P_{IN} - P_{OUT}$), and then subtracting the power losses in the free-wheeling diode and the inductor. The power loss in the diode is approximately:

$$P_{D1} = I_O \times V_F \times (1-D)$$

where

- I_O is the load current
- V_F is the diode's forward voltage drop
- D is the duty cycle

(23)

The power loss in the inductor is approximately:

$$P_{L1} = I_O^2 \times R_L \times 1.1$$

where

- R_L is the inductor's DC resistance
- 1.1 factor is an approximation for the AC losses



(24)

If it is expected that the internal dissipation of the LM2694 will produce high junction temperatures during normal operation, good use of the PC board's ground plane can help considerably to dissipate heat. The exposed pad on the WSON package bottom should be soldered to a ground plane, and that plane should both extend from beneath the IC, and be connected to exposed ground plane on the board's other side using as many vias as possible. The exposed pad is internally connected to the IC substrate. The use of wide PC board traces at the pins, where possible, can help conduct heat away from the IC. The four No Connect pins on the TSSOP package are not electrically connected to any part of the IC, and may be connected to ground plane to help dissipate heat from the package. Judicious positioning of the PC board within the end product, along with the use of any available air flow (forced or natural convection) can help reduce the junction temperature.

REVISION HISTORY

Changes from Original (April 2013) to Revision A	Page
• Changed layout of National Data Sheet to TI format	16

PACKAGING INFORMATION

Orderable Device	Status (1)	Package Type	Package Drawing	Pins	Package Qty	Eco Plan (2)	Lead finish/ Ball material (6)	MSL Peak Temp (3)	Op Temp (°C)	Device Marking (4/5)	Samples
LM2694MT/NOPB	ACTIVE	TSSOP	PW	14	94	RoHS & Green	SN	Level-1-260C-UNLIM		L2694 MT	
LM2694MTX/NOPB	ACTIVE	TSSOP	PW	14	2500	RoHS & Green	SN	Level-1-260C-UNLIM		L2694 MT	
LM2694SD/NOPB	ACTIVE	WSON	DSC	10	1000	RoHS & Green	SN	Level-1-260C-UNLIM	-40 to 125	L2694	

(1) The marketing status values are defined as follows:

ACTIVE: Product device recommended for new designs.

LIFEBUY: TI has announced that the device will be discontinued, and a lifetime-buy period is in effect.

NRND: Not recommended for new designs. Device is in production to support existing customers, but TI does not recommend using this part in a new design.

PREVIEW: Device has been announced but is not in production. Samples may or may not be available.

OBSOLETE: TI has discontinued the production of the device.

(2) **RoHS:** TI defines "RoHS" to mean semiconductor products that are compliant with the current EU RoHS requirements for all 10 RoHS substances, including the requirement that RoHS substance do not exceed 0.1% by weight in homogeneous materials. Where designed to be soldered at high temperatures, "RoHS" products are suitable for use in specified lead-free processes. TI may reference these types of products as "Pb-Free".

RoHS Exempt: TI defines "RoHS Exempt" to mean products that contain lead but are compliant with EU RoHS pursuant to a specific EU RoHS exemption.

Green: TI defines "Green" to mean the content of Chlorine (Cl) and Bromine (Br) based flame retardants meet JS709B low halogen requirements of <=1000ppm threshold. Antimony trioxide based flame retardants must also meet the <=1000ppm threshold requirement.

(3) MSL, Peak Temp. - The Moisture Sensitivity Level rating according to the JEDEC industry standard classifications, and peak solder temperature.

(4) There may be additional marking, which relates to the logo, the lot trace code information, or the environmental category on the device.

(5) Multiple Device Markings will be inside parentheses. Only one Device Marking contained in parentheses and separated by a "-" will appear on a device. If a line is indented then it is a continuation of the previous line and the two combined represent the entire Device Marking for that device.

(6) Lead finish/Ball material - Orderable Devices may have multiple material finish options. Finish options are separated by a vertical ruled line. Lead finish/Ball material values may wrap to two lines if the finish value exceeds the maximum column width.

Important Information and Disclaimer: The information provided on this page represents TI's knowledge and belief as of the date that it is provided. TI bases its knowledge and belief on information provided by third parties, and makes no representation or warranty as to the accuracy of such information. Efforts are underway to better integrate information from third parties. TI has taken and continues to take reasonable steps to provide representative and accurate information but may not have conducted destructive testing or chemical analysis on incoming materials and chemicals. TI and TI suppliers consider certain information to be proprietary, and thus CAS numbers and other limited information may not be available for release.

In no event shall TI's liability arising out of such information exceed the total purchase price of the TI part(s) at issue in this document sold by TI to Customer on an annual basis.

TAPE AND REEL INFORMATION

QUADRANT ASSIGNMENTS FOR PIN 1 ORIENTATION IN TAPE

*All dimensions are nominal

Device	Package Type	Package Drawing	Pins	SPQ	Reel Diameter (mm)	Reel Width W1 (mm)	A0 (mm)	B0 (mm)	K0 (mm)	P1 (mm)	W (mm)	Pin1 Quadrant
LM2694MTX/NOPB	TSSOP	PW	14	2500	330.0	12.4	6.95	5.6	1.6	8.0	12.0	Q1
LM2694SD/NOPB	WSOP	DSC	10	1000	178.0	12.4	3.3	3.3	1.0	8.0	12.0	Q1

TAPE AND REEL BOX DIMENSIONS

*All dimensions are nominal

Device	Package Type	Package Drawing	Pins	SPQ	Length (mm)	Width (mm)	Height (mm)
LM2694MTX/NOPB	TSSOP	PW	14	2500	367.0	367.0	35.0
LM2694SD/NOPB	WSON	DSC	10	1000	210.0	185.0	35.0

TUBE

*All dimensions are nominal

Device	Package Name	Package Type	Pins	SPQ	L (mm)	W (mm)	T (μm)	B (mm)
LM2694MT/NOPB	PW	TSSOP	14	94	495	8	2514.6	4.06

PW (R-PDSO-G14)

PLASTIC SMALL OUTLINE



- NOTES:
- A. All linear dimensions are in millimeters. Dimensioning and tolerancing per ASME Y14.5M-1994.
 - B. This drawing is subject to change without notice.
 - C. Body length does not include mold flash, protrusions, or gate burrs. Mold flash, protrusions, or gate burrs shall not exceed 0,15 each side.
 - D. Body width does not include interlead flash. Interlead flash shall not exceed 0,25 each side.
 - E. Falls within JEDEC MO-153

PW (R-PDSO-G14)

PLASTIC SMALL OUTLINE



4211284-2/G 08/15

- NOTES:
- All linear dimensions are in millimeters.
 - This drawing is subject to change without notice.
 - Publication IPC-7351 is recommended for alternate designs.
 - Laser cutting apertures with trapezoidal walls and also rounding corners will offer better paste release. Customers should contact their board assembly site for stencil design recommendations. Refer to IPC-7525 for other stencil recommendations.
 - Customers should contact their board fabrication site for solder mask tolerances between and around signal pads.

EXAMPLE BOARD LAYOUT

DSC0010B

WSON - 0.8 mm max height

PLASTIC SMALL OUTLINE - NO LEAD

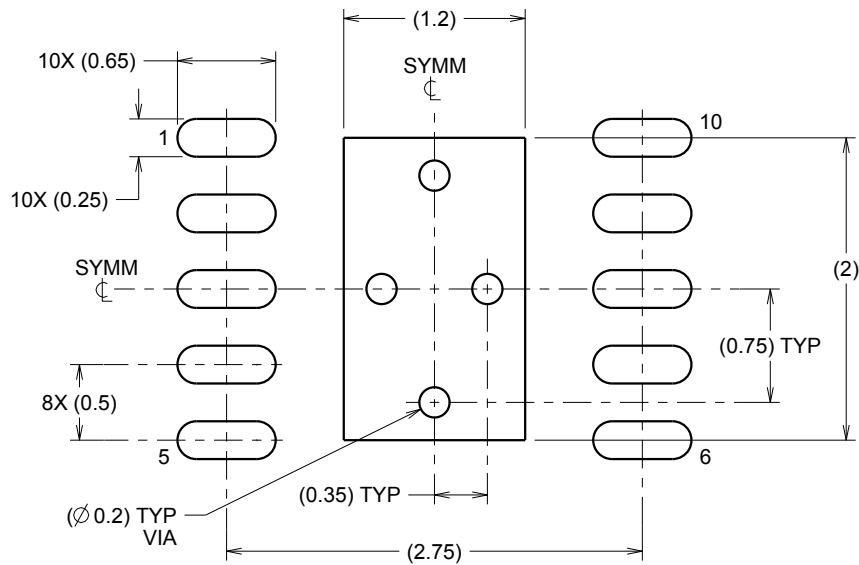

LAND PATTERN EXAMPLE
SCALE:20X

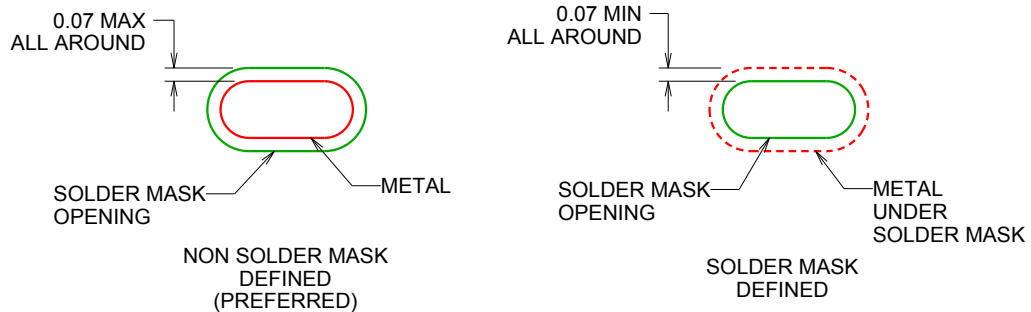

SOLDER MASK DETAILS

4214926/A 07/2014

NOTES: (continued)

4. This package is designed to be soldered to a thermal pad on the board. For more information, see Texas Instruments literature number SLUA271 (www.ti.com/lit/slua271).

EXAMPLE STENCIL DESIGN

DSC0010B

WSON - 0.8 mm max height

PLASTIC SMALL OUTLINE - NO LEAD

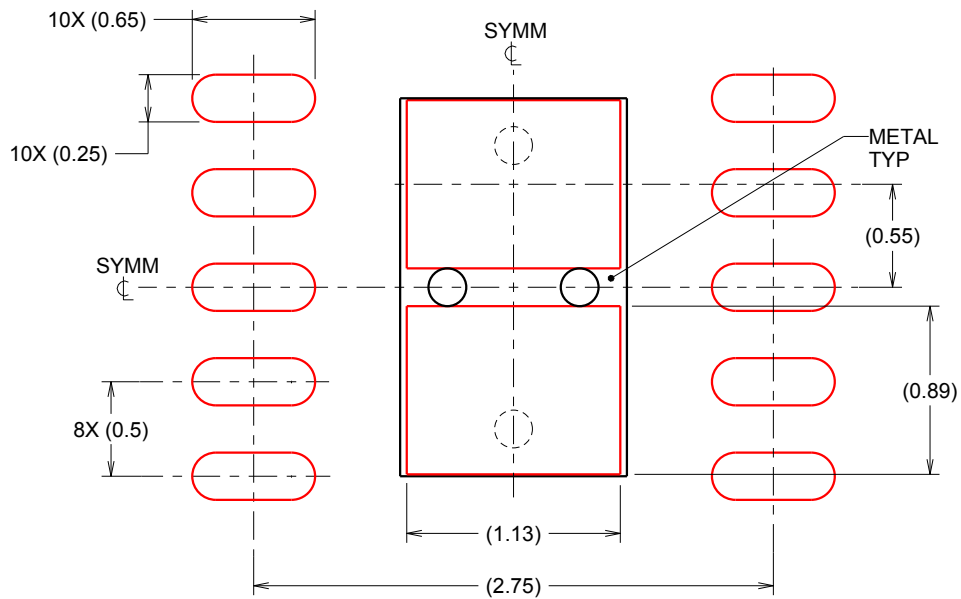

SOLDER PASTE EXAMPLE
BASED ON 0.125 mm THICK STENCIL

EXPOSED PAD
84% PRINTED SOLDER COVERAGE BY AREA
SCALE:25X

4214926/A 07/2014

NOTES: (continued)

5. Laser cutting apertures with trapezoidal walls and rounded corners may offer better paste release. IPC-7525 may have alternate design recommendations.

IMPORTANT NOTICE AND DISCLAIMER

TI PROVIDES TECHNICAL AND RELIABILITY DATA (INCLUDING DATA SHEETS), DESIGN RESOURCES (INCLUDING REFERENCE DESIGNS), APPLICATION OR OTHER DESIGN ADVICE, WEB TOOLS, SAFETY INFORMATION, AND OTHER RESOURCES "AS IS" AND WITH ALL FAULTS, AND DISCLAIMS ALL WARRANTIES, EXPRESS AND IMPLIED, INCLUDING WITHOUT LIMITATION ANY IMPLIED WARRANTIES OF MERCHANTABILITY, FITNESS FOR A PARTICULAR PURPOSE OR NON-INFRINGEMENT OF THIRD PARTY INTELLECTUAL PROPERTY RIGHTS.

These resources are intended for skilled developers designing with TI products. You are solely responsible for (1) selecting the appropriate TI products for your application, (2) designing, validating and testing your application, and (3) ensuring your application meets applicable standards, and any other safety, security, regulatory or other requirements.

These resources are subject to change without notice. TI grants you permission to use these resources only for development of an application that uses the TI products described in the resource. Other reproduction and display of these resources is prohibited. No license is granted to any other TI intellectual property right or to any third party intellectual property right. TI disclaims responsibility for, and you will fully indemnify TI and its representatives against, any claims, damages, costs, losses, and liabilities arising out of your use of these resources.

TI's products are provided subject to [TI's Terms of Sale](#) or other applicable terms available either on ti.com or provided in conjunction with such TI products. TI's provision of these resources does not expand or otherwise alter TI's applicable warranties or warranty disclaimers for TI products.

TI objects to and rejects any additional or different terms you may have proposed.

Mailing Address: Texas Instruments, Post Office Box 655303, Dallas, Texas 75265
Copyright © 2022, Texas Instruments Incorporated