

AN-898 Audio Amplifiers Utilizing: SPiKe™ Protection

ABSTRACT

This application report explains in detail each of the protections provided by SPiKe protected audio amplifiers, the advantages they bring to audio designers, and why they are necessary.

Contents

1	Introduction	3
2	Self Peak Instantaneous Temperature Limiting (SPiKe)	3
3	Overvoltage—Output Voltage Clamping	9
4	Undervoltage—Popless Power-On/Off	15
5	Current Limiting—Output Short to Ground	15
6	Current Limiting—Output Short to Supply	18
7	Thermal Shutdown—Continuous Temperature Rise	20

List of Figures

1	Amplifier Equivalent Schematic with Simplified SPiKe Protection Circuitry	3
2	Safe Operating Area $T_C = 25^\circ\text{C}$	4
3	Safe Operating Area $T_C = 75^\circ\text{C}$	5
4	Safe Operating Area $T_C = 125^\circ\text{C}$	5
5	SPiKe Protection Response $T_C = 75^\circ\text{C}$	6
6	SPiKe Protection Response $T_C = 80^\circ\text{C}$	6
7	SPiKe Protection Response $T_C = 85^\circ\text{C}$	7
8	Pulse Power Limit, Pulse Power Dissipation vs Pulse Width	8
9	Pulse Power Limit, Pulse Power Dissipation vs V_{CE}	8
10	Positive Output Voltage Clamping Waveform	9
11	Negative Output Voltage Clamping Waveform	10
12	Output Stage Overvoltage Model (V_{CC})	10
13	Output Stage Overvoltage Model ($-V_{EE}$)	11
14	Overvoltage Exceeding Clamping Level	13
15	Reaching the SOA Power Limit, $f = 100\text{ Hz}$, SPiKe Enabled	13
16	Multiple SOA Power Limits	14
17	Output Saturation Causing Extreme Overvoltage	14
18	Output Waveform Resulting from Power-On Undervoltage Protection	16
19	Output Waveform Resulting from Power-Off Undervoltage Protection	16
20	Output Waveform Resulting from Power-Off Undervoltage Protection	17
21	LM3876 Typical Current Limiting with SPiKe Protection ON	17
22	$t_w = 100\ \mu\text{s}$, t_{SPiKe} (Not Enabled)	18
23	$t_w = 1\ \text{ms}$, $t_{SPiKe} = 200\ \mu\text{s}$	19
24	$t_w = 10\ \text{ms}$, $t_{SPiKe} = 195\ \mu\text{s}$	19
25	Junction Temperature vs Time	20
26	Thermal Shutdown Waveform	21

SPiKe, Overture are trademarks of Texas Instruments.
 All other trademarks are the property of their respective owners.

27	Actual Thermal Shutdown Waveform	21
----	--	----

1 Introduction

As technology develops, integrated circuits continue to provide an advantage to consumers requiring products with more functionality and reliability for their money. It's been less than fifty years since the first transistor began to provide audio amplification to consumers. Technology changed, bringing to the market higher power discretes and hybrids with the later development of lower powered monolithics. Today with the development of IC technologies, high-performance monolithic audio amplifiers arrive, allowing consumers to experience high-power, high-fidelity audio systems in compact packages.

The Overture™ Audio Power Amplifier Series possesses a unique protection system that saves audio amplifier designers components, size, and cost of their systems. This translates into higher-power, more functional, more reliable, compact audio amplification systems.

These advantages, generally provided only in high-end discrete amplifiers, are accomplished by providing a protection mechanism within a monolithic power package. Since audio amplifier designers generally need to provide some sort of protection to the output transistors in order to keep product failures to a minimum, Texas Instruments has designed SPiKe (Self Peak Instantaneous Temperature (°Ke)) Protection. This is a protection mechanism designed to safeguard the amplifier's output from overvoltages, undervoltages, shorts to ground or to the supplies, thermal runaway, and instantaneous temperature peaks.

Each of the protection sections on the following pages will refer to Figure 1. (Amplifier Equivalent Schematic with Simplified SPiKe Protection Circuitry) when its functionality is described.

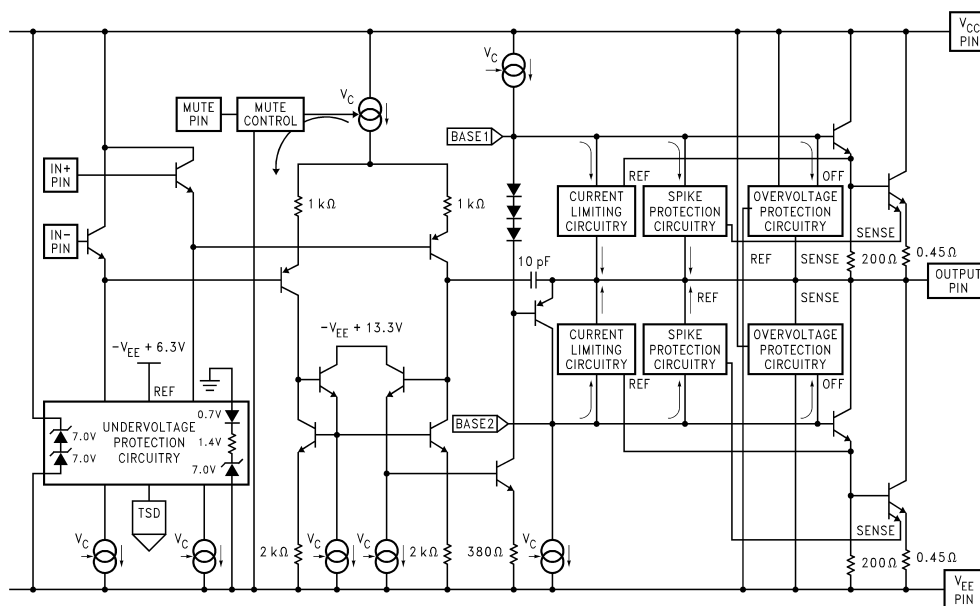

Figure 1. Amplifier Equivalent Schematic with Simplified SPiKe Protection Circuitry

2 Self Peak Instantaneous Temperature Limiting (SPiKe)

SPiKe Protection is a “uniquely-smart” protection mechanism that will adjust its output drive capability according to its output operating conditions, thus safeguarding itself against the most stringent power limiting conditions.

Other power amplifiers on the market provide SOA protection by calculating external resistances for adjustable current limiting whose primary function is to keep the amplifier within its safe operating area. Not only do these amplifiers require external components, but they also have a design conflict between fault protection and maximum output current drive capability. In order to keep the device from self-destructing against output shorts to either supply rail, the adjustable current limit must be significantly lowered, thus limiting the device's current drive capability.

SPiKe protected audio amplifiers provide extensive fault protection without sacrificing output current drive capability. Its circuitry functions by sensing the output transistor's temperature, enabling itself when the temperature reaches approximately 250°C. Depending upon the amplifier's present operating conditions, the device will reduce the output drive transistor's base current, as shown in Figure 1, keeping the transistor within its safe operating area.

The uniqueness of SPiKe protected audio amplifiers is its ability to monitor the output drive transistor's safe operating area dynamically, regardless of an output to ground short, an output to supply short, or the reaching of its power limit by any pulse within the audio spectrum.

As can be seen from Figure 2, Figure 3, and Figure 4, the safe operating area is reduced for all pulse widths as the case temperature increases. This indicates that good heatsinking is required for optimal operation of the power amplifier. Figure 5, Figure 6, and Figure 7 illustrate the reduction of the safe operating area by the increasing effect of enabling SPiKe Protection on a 100 Hz sine wave due to increasing case temperatures.

As seen in Section 5, a short to ground with an input pulse applied to the amplifier will be current limited by the conventional current limiting circuitry for a few hundred microseconds. When the junction temperature reaches its limit, SPiKe protection takes over, limiting the output current further, as the junction temperature tries to rise above 250°C.

This protection scheme results in the power capabilities being dependent upon the case temperature, the transistor operating voltages, V_{CE} , and the power dissipation versus time.

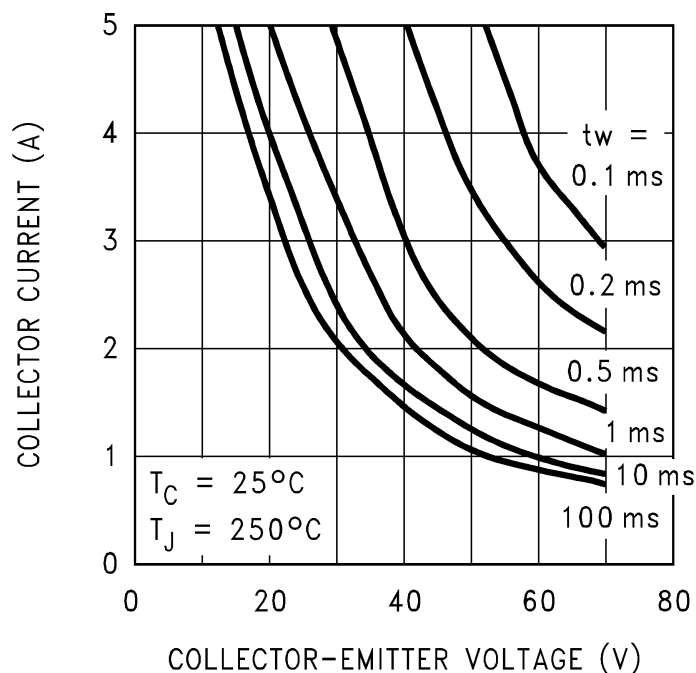

Figure 2. Safe Operating Area $T_C = 25^\circ\text{C}$

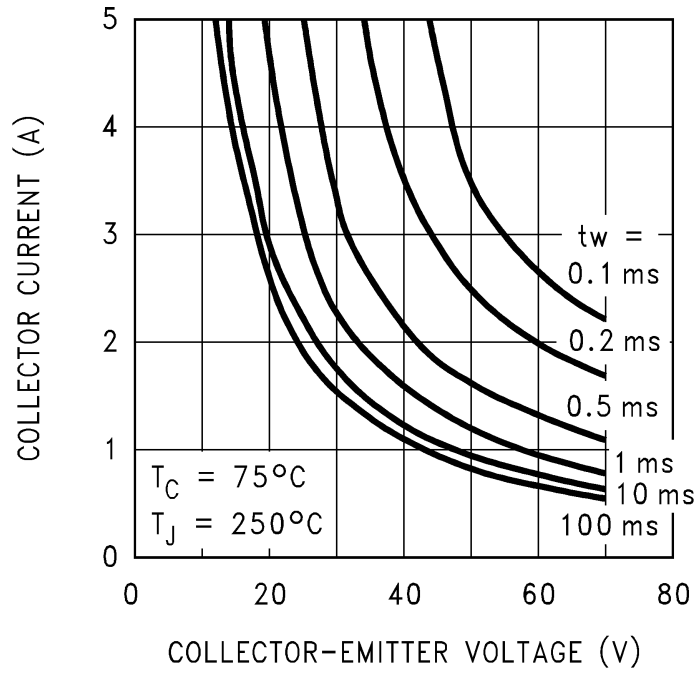

Figure 3. Safe Operating Area $T_C = 75^\circ\text{C}$

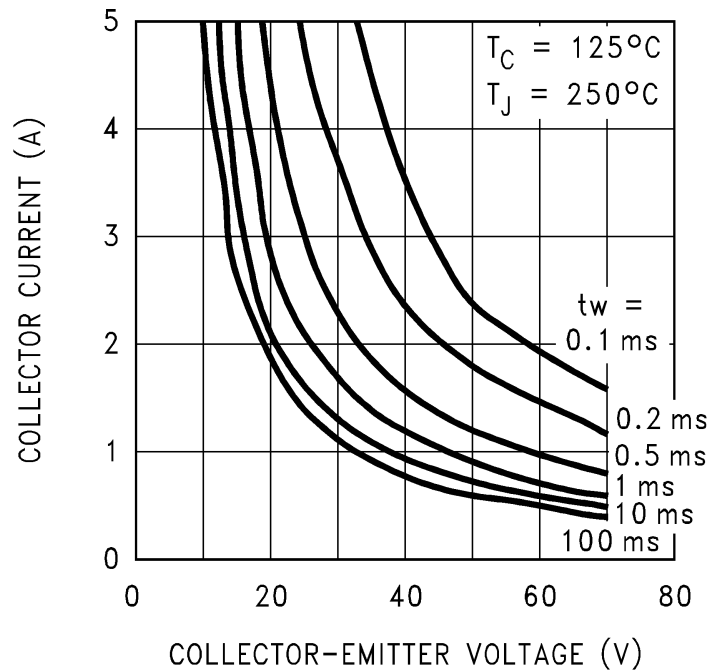

Figure 4. Safe Operating Area $T_C = 125^\circ\text{C}$

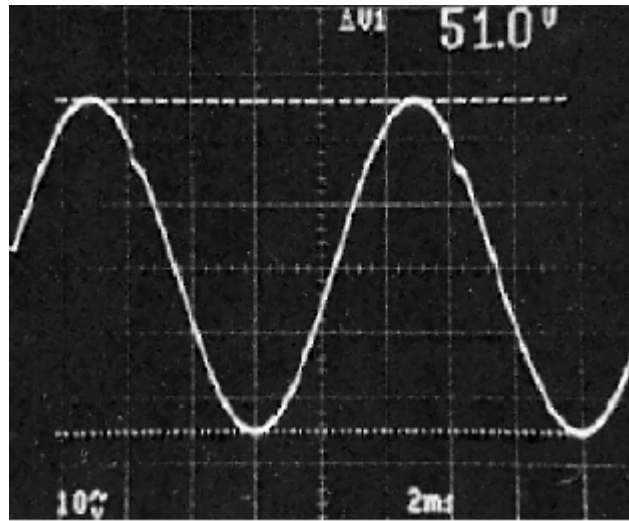

Figure 5. SPiKe Protection Response $T_C = 75^\circ\text{C}$

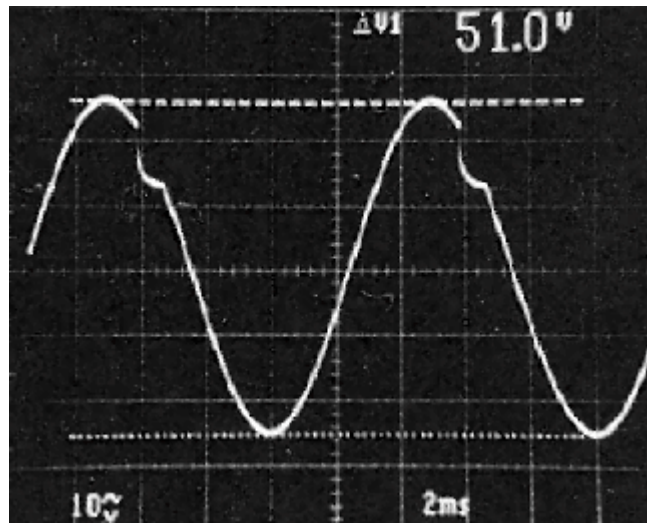

Figure 6. SPiKe Protection Response $T_C = 80^\circ\text{C}$

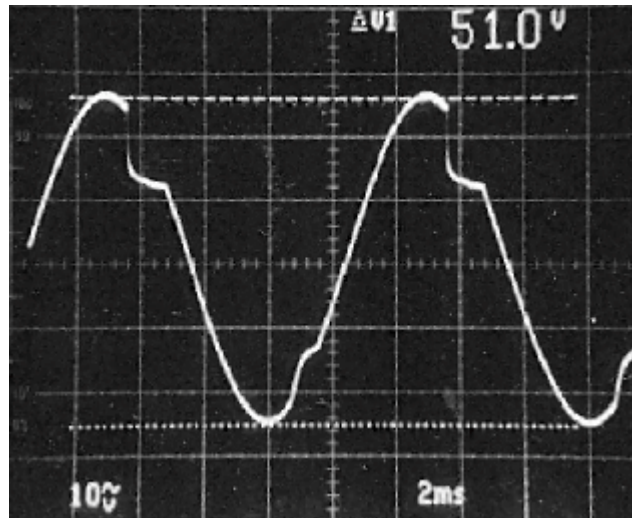

Figure 7. SPiKe Protection Response $T_c = 85^\circ\text{C}$

Figure 8 and Figure 9 are provided for each SPiKe Protected audio power amplifier and should be used to determine the power transistor's peak dissipation capabilities and the power required to activate the power limit. This information may help a designer to determine the maximum amount of power that SPiKe protected amplifiers may deliver into different loads before enabling SPiKe protection.

Figure 8 shows the peak power dissipation capabilities of the output drive transistor at increasing case temperatures for various output pulse widths.

Figure 9 shows the power required to activate SPiKe circuitry at increasing case temperatures over the operating voltage range.

Again, it is evident that good heatsinking and ventilation within the system are important to the design in order to achieve maximum output power from the amplifier.

SPiKe protected amplifiers provide the capability of regulating temperature peaks that may be caused by reaching the power limit of the safe operating area. The reaching of power limits may result from increased case temperatures while heavily driving a load or by conventional current limiting, resulting from the output being shorted to ground or to the supplies.

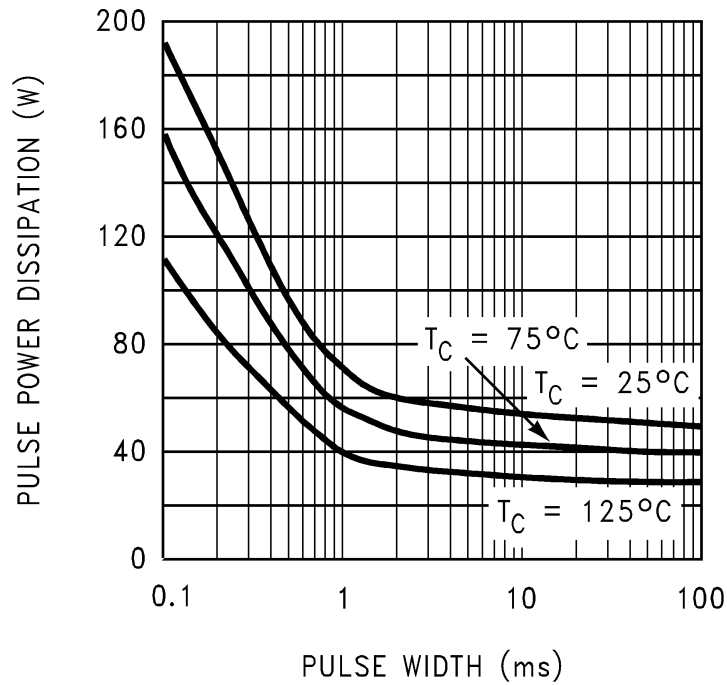

Figure 8. Pulse Power Limit, Pulse Power Dissipation vs Pulse Width

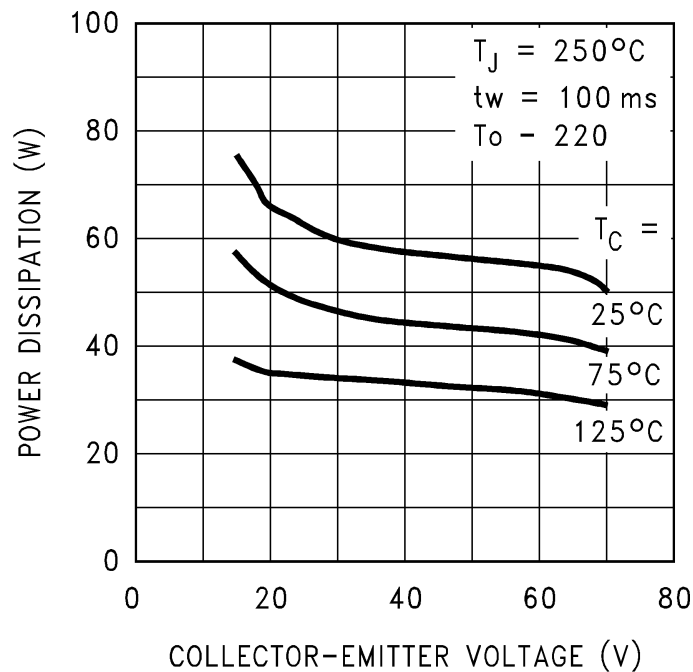

Figure 9. Pulse Power Limit, Pulse Power Dissipation vs V_{CE}

3 Overvoltage—Output Voltage Clamping

One of the most important protection schemes of an audio amplifier is the protection of the output drive transistors against large voltage flyback spikes. These spikes are created by the sudden attempt to change the current flow in an inductive load, such as a speaker. When a push-pull amplifier goes into power limit (that is, reaching the SOA limit) while driving an inductive load, the current present in the inductor drives the output beyond the supplies. This large voltage spike may exceed the breakdown voltage rating of a typical audio amplifier and destroy the output drive transistor. In general, the amplifier should not be stressed beyond its *Absolute Maximum* (No Signal) Voltage Supply Rating and should be protected against any condition that may lead to this type of voltage stress level. This type of protection generally requires the use of costly zener or fast recovery Schottky diodes from the output of the device to each supply rail.

However, SPiKe protected audio amplifiers possess a unique overvoltage protection scheme that allows the device to sustain overvoltages for nominally rated speaker loads. Referring to [Figure 1](#), the protection mechanism functions by first sensing that the output has exceeded the supply rail, then immediately turns the driving output transistor off so that its breakdown voltage is not exceeded. The circuitry continues to monitor the output, waiting to turn the output drive transistor back on when the overvoltage fault has ceased.

While monitoring the output, the IC also provides SPiKe protection if needed. Finally, SPiKe protected audio amplifiers possess an internal supply-clamping mechanism; a zener plus a diode drop from the output to the positive supply rail and an intrinsic diode drop from the output to the negative rail. This equates to clamping of approximately 8V on the positive rail and 0.8V on the negative rail as can be seen in [Figure 10](#) and [Figure 11](#), respectively.

[Figure 12](#) and [Figure 13](#) model the output stage for each overvoltage condition exemplifying how the voltage waveforms are clamped to their respective values for high frequency waveforms. As shown in the Self Peak Instantaneous Temperature Limiting (SPiKe) section, [Figure 2](#), [Figure 3](#), and [Figure 4](#), the safe operating area for lower frequency waveforms is much smaller than for higher frequency waveforms. Therefore, the power limits of low frequency waveforms may be reached much more easily than for high frequency waveforms. It is due to this fact that more extreme and more frequent overvoltages may occur at lower frequencies, as shown in [Figure 14](#), [Figure 15](#), [Figure 16](#), and [Figure 17](#). The peak output voltage spikes may increase beyond the described clamping values due to extreme power conditions, however, the waveforms will decrease to the clamping values with the discharge of the output inductor current, as shown in [Figure 14](#).

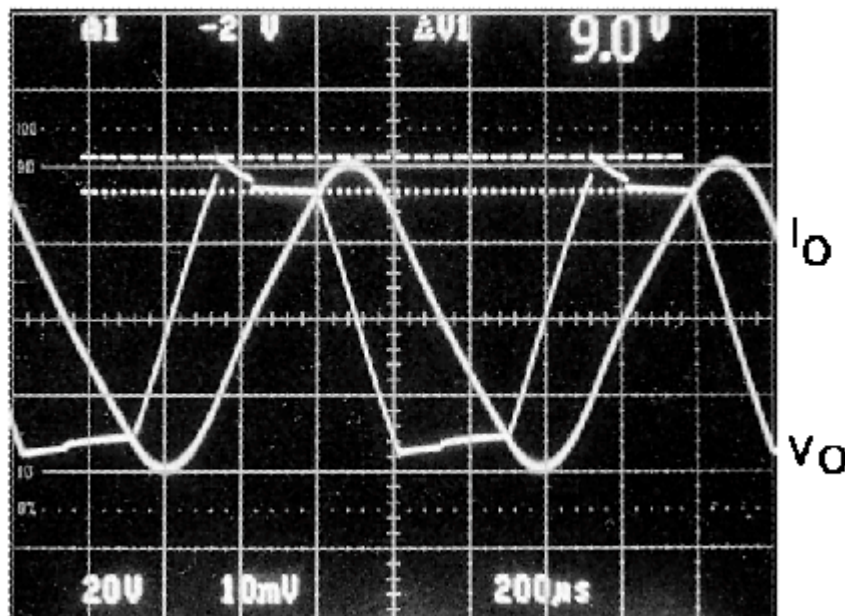

Figure 10. Positive Output Voltage Clamping Waveform

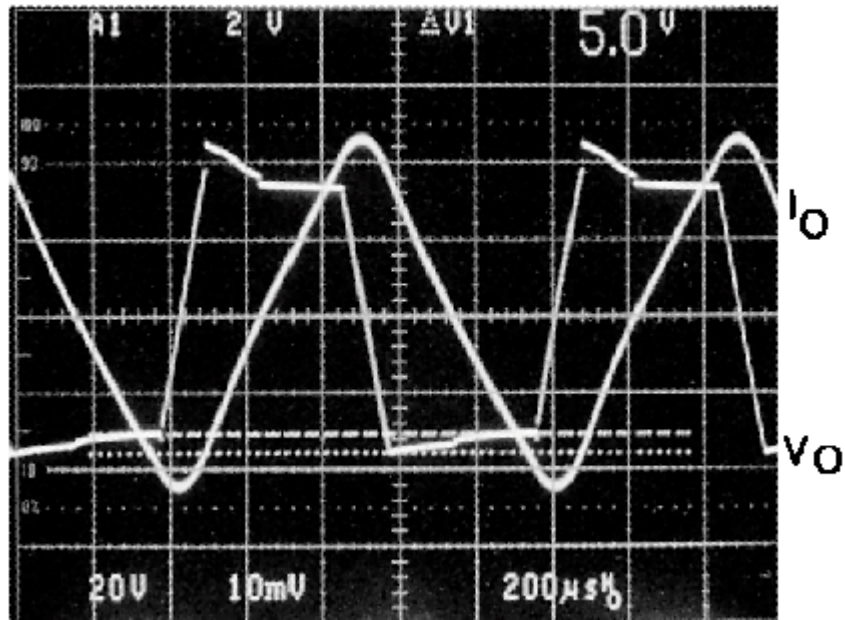

Figure 11. Negative Output Voltage Clamping Waveform

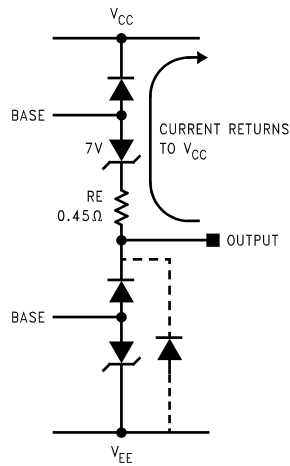

Figure 12. Output Stage Overvoltage Model (V_{CC})

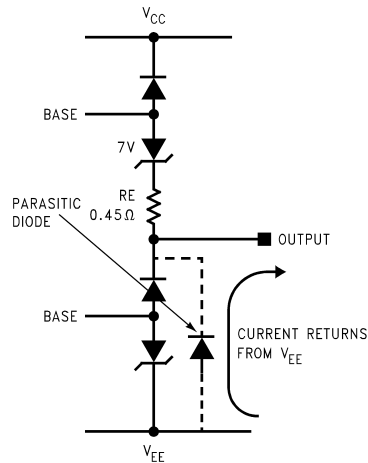

Figure 13. Output Stage Overvoltage Model ($-V_{EE}$)

The lower output stage has the advantage of an intrinsic diode from the negative rail to the output which can replace the usual external clamping diode in an audio amplifier. This intrinsic diode is an advantage of the monolithic IC, capable of handling the large current flowing through the load at the time of the power limit.

The system is not protected against all reactive loads since these clamping diodes will dissipate large amounts of power that cannot be controlled by the peak temperature limiting circuitry if the fault is sustained for a long period of time. It should also be noted that for purely reactive loads, all of the power is dissipated in the amplifier and none in the load. This implies that if the load is more reactive than resistive, at those frequencies, more power will be dissipated in the amplifier than delivered to the speaker. Since the impedance characteristics of a speaker change over frequency, it is very important to know what types of loads the amplifier can and cannot drive in order to not only match the amplifier and speaker for optimum performance, but also to protect the amplifier from trying to outperform itself. It is the mismatching of components or low dips in the resistive component of a complex speaker that can cause an amplifier to go into power limit. The likelihood of reaching the amplifier's power limit is greatly reduced when the minimum impedance that the amplifier can drive is known.

Figure 14, Figure 15, Figure 16, and Figure 17 are examples of the LM3876 reaching its power limit, experiencing large flyback voltages from an inductive load, for various input signals and loads.

The test conditions for [Figure 14](#), [Figure 15](#), [Figure 16](#), and [Figure 17](#) are as follows:

- Using an LM3876
- No external compensation components
- $V_{CC} = \pm 35V$
- $A_{V_{CL}} = 20$
- $I_O/Div. = 2.0A/div$
- $Z_L = 7.5\text{ mH} + 4\Omega$ for [Figure 14](#)
- $Z_L = 7.5\text{ mH} + 2\Omega$ for [Figure 15](#), [Figure 16](#), and [Figure 17](#)
- $f = 100\text{ Hz}$ for [Figure 14](#), [Figure 15](#), and [Figure 17](#)
- $f = 70\text{ Hz}$ for [Figure 16](#)

In [Figure 14](#), the 4.5Vpk input signal applied to the amplifier with a closed-loop gain of 20, produces the severely clipped 34V output voltage waveform, as shown. The sharp 48.5V overvoltage spike that occurs at the crossover point is due to the amplifier output stage reaching the SOA (Safe Operating Area) limit. For this waveform, the collector-emitter voltage is quite large, while the output current is also quite large (4A). Referring to [Figure 2](#), [Figure 3](#), and [Figure 4](#), it is easily understood that the SOA power limit has been reached.

When the SOA limit is reached, the SPiKe protection circuitry tries to limit the output current while the inductor tries to continuously supply the current it has stored. Since the current in an inductor can't change instantaneously, the current is driven back into the output up through the upper drive transistor, as shown in [Figure 12](#).

It is this current that causes the large flyback voltage spike on the output waveform. The peak of the voltage spike can be found by taking the current going through the output at the time of the power limit multiplied by the 0.45Ω emitter resistor and adding it to the zener-diode combination. In [Figure 10](#) this would be (2A)(0.45Ω) + 8V which is approximately 9V, as shown by the cursors. For the lower output stage, the clamping voltage is controlled by an intrinsic diode that replaces costly output clamping diodes.

In [Figure 14](#), when the current reaches close to zero, the voltage at the output tends to move towards the output voltage that it would have been if the power limit had not been reached. This is typical for all overvoltage occurrences. It should be noted that when the overvoltage fault occurs, the device is no longer functioning in the closed-loop mode.

In [Figure 15](#), one waveform is actually a sinewave with SPiKe protection enabled, as in [Figure 5](#), [Figure 6](#), and [Figure 7](#) with the same overvoltage spikes as in [Figure 14](#) and the other waveform is the output current. In the middle of the response, the current is rising toward 6A when SPiKe is enabled, causing a "bite" to be taken out of the sinewave. The device is just trying to limit the output current at this point, as explained in the SPiKe Protection section. The overvoltage flyback spike then occurs while the output current discharges to zero. However, this time when the current reaches zero, the current and voltage must make up for what it had lost and try to return to its position on the amplified input waveform. The voltage jumps up to its value, but the current must slowly and continuously charge up to its place on the current waveform, then continue downward as the lower output stage starts sinking current. It must be remembered that the current waveform would have been a sinewave if the SOA power limit hadn't been reached.

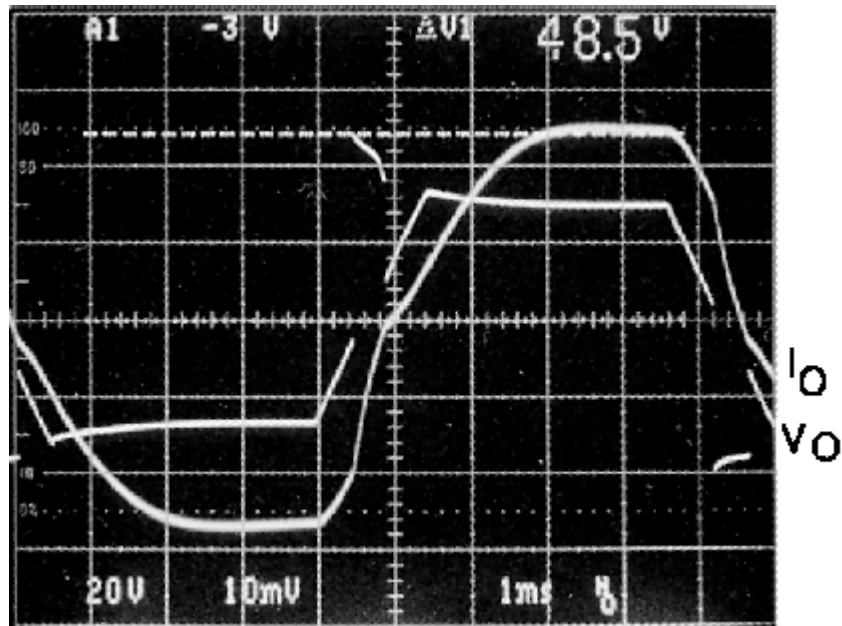

Figure 14. Overvoltage Exceeding Clamping Level

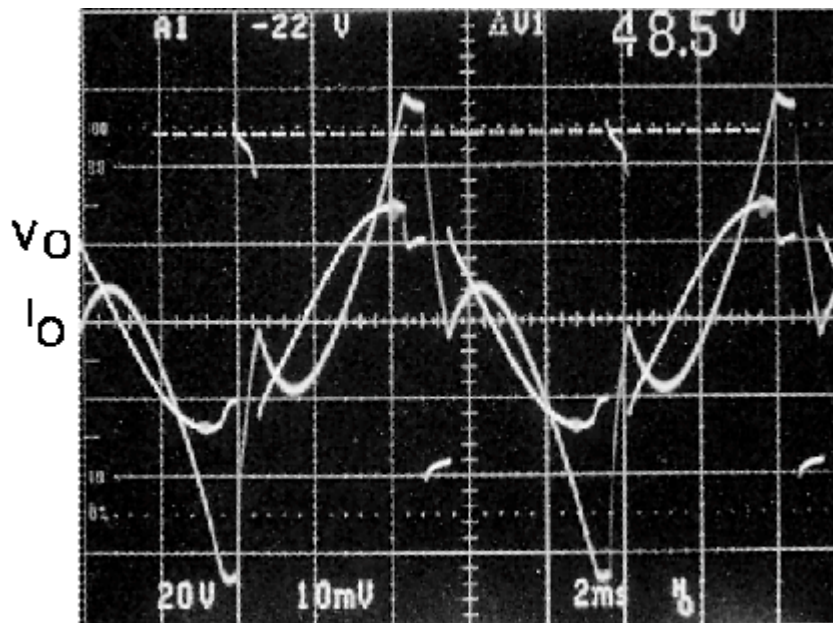

Figure 15. Reaching the SOA Power Limit, $f = 100$ Hz, SPIke Enabled

Multiple SOA power limits on the output waveform are the difference between [Figure 15](#) and [Figure 16](#). [Figure 16](#) is intended to show that multiple SOA power limits can occur under extreme loading conditions. The amplifier is trying to drive a 70 Hz sinewave into a 7.5 mH inductor in series with a 2Ω resistor. As the signal frequency decreases, with a low resistance load, the number of SOA power limits will increase. The frequency of reaching power limits will depend upon the size of the reactance as the load.

Figure 17 is intended to exemplify the large current overdrive that can occur when the output waveform is driven hard into the rails. Notice that the current is over 6Apk for each voltage swing.

It must be remembered that it is the large voltage across the output drive transistors that would normally exceed a discrete output transistor's breakdown voltage. A discrete power transistor that is not protected with output clamping diodes would be destroyed if its breakdown voltage was exceeded. SPiKe protected audio amplifiers clearly show the ability to withstand overvoltages created by low impedance loads.

The integration of output overvoltage protection within monolithic audio amplifiers provides the advantage of eliminating expensive fast-recovery Schottky diodes that would be used in a discrete design, thus resulting in fewer external components and a lower system cost.

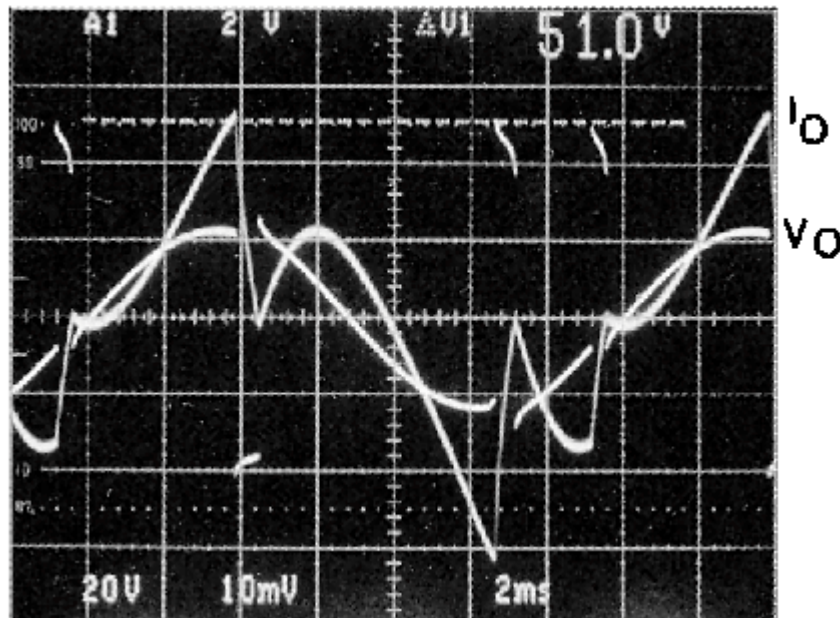

Figure 16. Multiple SOA Power Limits

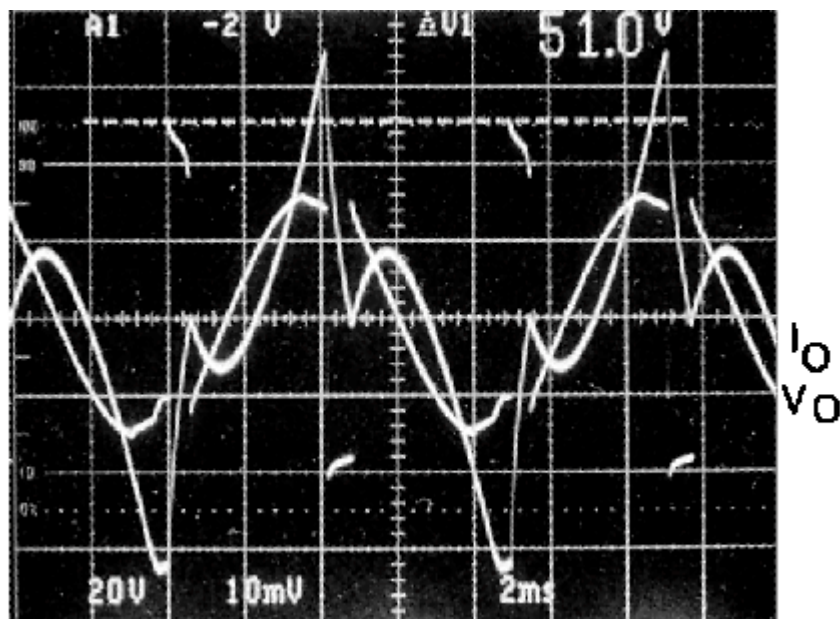

Figure 17. Output Saturation Causing Extreme Overvoltage

4 Undervoltage—Popless Power-On/Off

SPIKe protected audio amplifiers possess a unique undervoltage protection circuit that eliminates the annoying and destructive pops that occur at the output of many amplifiers during power-up/down. SPIKe's undervoltage protection was designed because all DC voltage shifts or “pops” at the output should be avoided in any audio amplifier design, due to their destructive capability on a speaker. These pops are generally a result of the unstable nature of the output as internal biasing is established while the power supplies are coming up.

SPIKe Protection accomplishes this by disabling the output, placing it in a high impedance state, while its biasing is established. This function is achieved through the disabling of all current sources within the device as denoted by control signal V_C , in [Figure 1](#). For the LM2876, LM3876, and LM3886, the control signal will not allow the current sources to function until 1) the total supply voltage, from the positive rail to the negative rail, is greater than 14V and 2) the negative voltage rail exceeds $-9V$. The LM3875 is undervoltage protected with the relative 14V total supply voltage condition only. Thus for the “6”-series, the amplifiers will not amplify audio signals until both of these conditions are met. It is this $-9V$ protection that causes the undervoltage protection scheme to disable the output up to 18V between the positive and negative rail, assuming that both supply rails come up simultaneously. This can be seen in [Figure 18](#). The $-9V$ undervoltage protection is ground referenced to eliminate the possibility of large voltage spikes, that occur on the supplies, which may enable the relative 14V undervoltage protection momentarily.

It should be noted that the isolation from the input to the output, when the output is in its high-impedance state, is dependent upon the interaction of external components and traces on the circuit board.

As can be seen in [Figure 18](#) and [Figure 19](#), the transition from ground to $\pm V_{CC}$ and from $\pm V_{CC}$ to ground upon power-on/off is smooth and free of “pops”. It can also be seen from the magnification of [Figure 18](#) in [Figure 20](#), that the amplifier doesn't start amplifying the input signal until the supplies reach $\pm 9V$. It is also evident that there is no feedthrough from 0V to $\pm 9V$. It must be noted that the sinewave being amplified is clipped initially as the supplies are coming up, but after the supplies are at their full values, the output sinewave is actually below the clipping level of the amplifier.

It should also be noted that the waveforms were obtained with the mute pin of the LM3876 sourcing 0.5 mA, its 0 dB attenuation level. If the mute pin is sourcing less than 0.5 mA, the nonlinear attenuation curve may induce crossover distortion or signal clipping. The Mute Attenuation curves vs. Mute Current in the datasheets of the LM2876, LM3876, and LM3886 show this nonlinear characteristic. The LM3875 is the sister part to the LM3876 and does not have a mute function.

For optimum performance, the mute function should be either enabled or disabled upon power-up/down. Although the undervoltage protection circuitry is not dependent upon the mute pin and its external components, the mute function can be used in conjunction with the undervoltage function to provide a longer turn-on delay. It should be noted that the mute function is also popless. Of the multiple ways to set the mute current and utilize the mute function, the use of a regulator can continuously control the amount of current out of the mute pin. This regulation concept keeps the attenuation level from dropping below 0 dB when the supply is sagging. More information about mute circuit configurations will be provided later in a future application report.

The advantages of undervoltage protection in SPIKe protected audio amplifiers are that no pops occur at the output upon power-up/down. Customers can also be assured that their speakers are protected against DC voltage spikes when the amplifier is turned on or off.

5 Current Limiting—Output Short to Ground

Whether in the lab or inside a consumer's home, the possibility of an amplifier output short to ground exists. If current limiting is not provided within the amplifier, the output drive transistors may be damaged. This means one of two things, either sending the unit to customer service for repair or if you're in the lab, throwing the discrete drive transistor or hybrid unit away and replacing it with a new one. SPIKe protected audio amplifiers eliminate this costly, time-consuming hassle by providing current limiting capability internally.

This also means that the multiple components required to provide current limiting capability in a discrete design are eliminated with the monolithic audio amplifier solution, once again, reducing the system size and cost.

The value of the current limit will vary for each particular audio amplifier and its output drive capability. Please refer to each amplifier's datasheet Electrical Characteristics section for particular current limits.

As can be seen in Figure 21, the value of current limiting for the LM3876 is typically 6 Apk when $V_{CC} = \pm 35V$ and $R_L = 1\Omega$. From the scope cursors at the top of the waveform $I_{LIMIT} = V_o/R_L$. This test was performed with a closed-loop gain of 20 and an input signal of 2V ($t_w = 10$ ms).

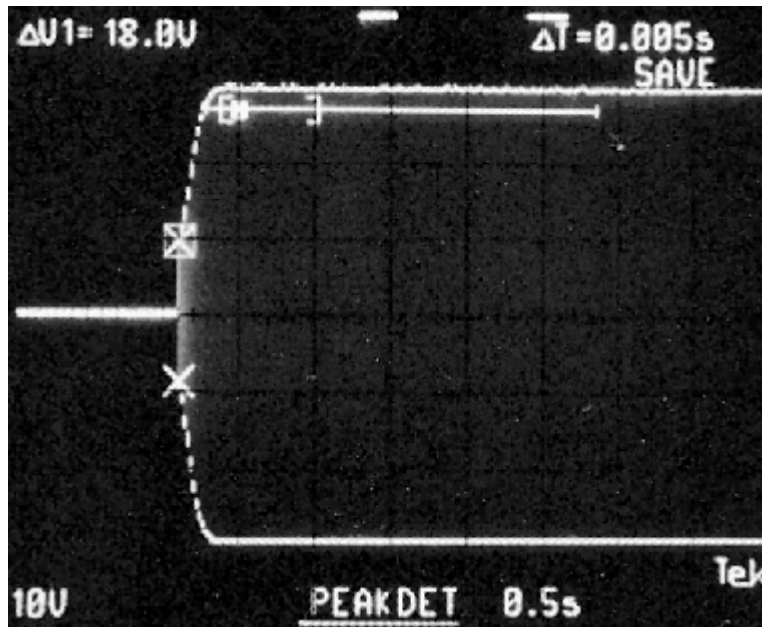

Figure 18. Output Waveform Resulting from Power-On Undervoltage Protection

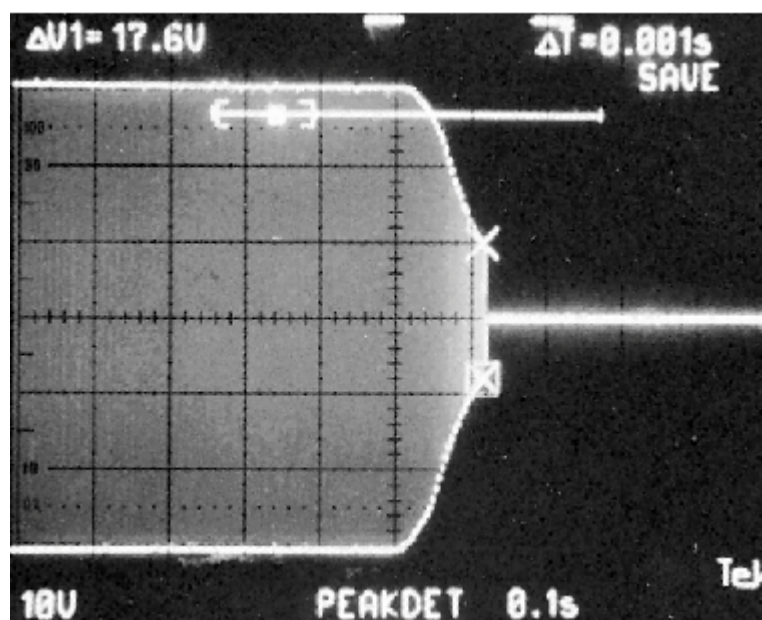

Figure 19. Output Waveform Resulting from Power-Off Undervoltage Protection

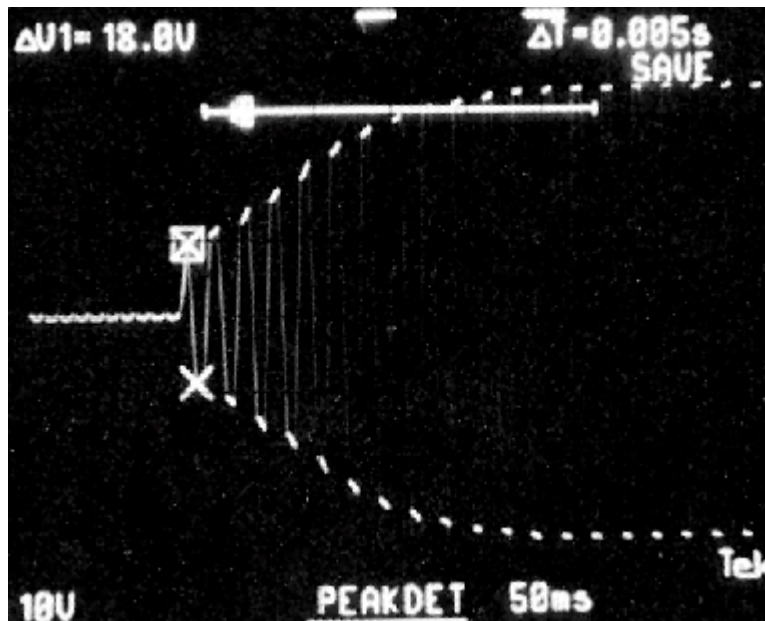

Figure 20. Output Waveform Resulting from Power-Off Undervoltage Protection

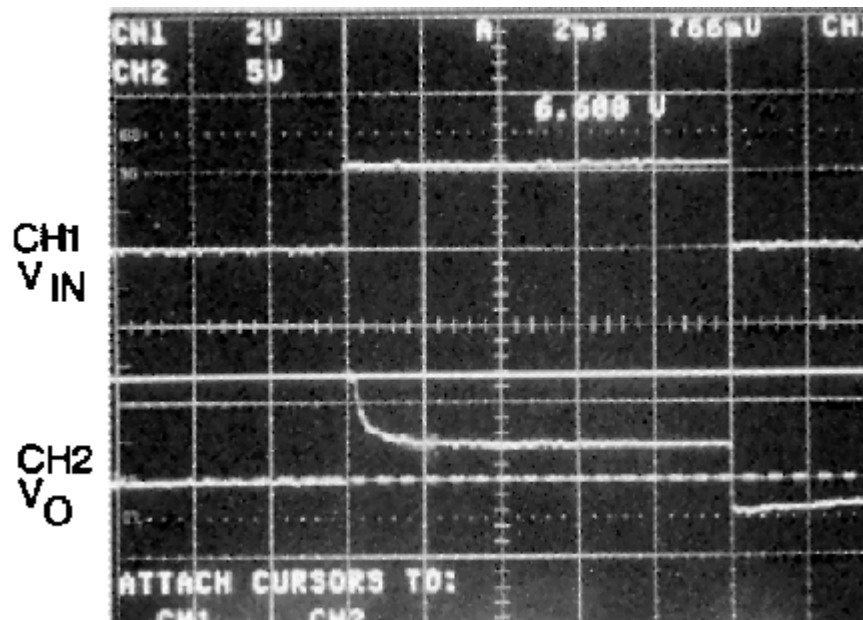

Figure 21. LM3876 Typical Current Limiting with SPiKe Protection ON

Notice that the initial current limit is at its peak value of approximately 6A, but as time increases, the final current limit decreases. This is due to the enabling of the instantaneous temperature limiting circuitry or SPiKe protection. When the IC is in current limiting, the temperature of the output drive transistor array increases to its limit of 250°C, at which time SPiKe protection is enabled, reducing the amount of output drive current. It is this further reduction of its drive current that prevents the output drive transistor from exceeding the safe operating area.

As shown in [Figure 22](#), [Figure 23](#), and [Figure 24](#) as the input pulses' time increases, the level of SPiKe protection imposed on the waveform increases. It should be noted that SPiKe protection was enabled after 200 μs of current limiting in [Figure 23](#) and [Figure 24](#), but is in general dependent upon the case temperature, the transistor operating current and voltage, and its power dissipation versus time.

The internal current limiting circuitry functions by monitoring the output drive transistor current. The sensing of an increase in this current signals the circuitry to pull away drive current from the base of the output drive transistor as shown in [Figure 1](#). The harder the input tries to drive the output, the more current is pulled away from the output drive transistor, thus internally limiting the output current.

Another point worth mentioning is that with increasing supply voltages, the turn-on point of SPiKe protection, when in current limiting, will decrease. Since the internal power dissipation is greater, it will take a shorter amount of time before the temperature of the output drive transistor increases to the SOA limit.

Once again, SPiKe protected audio amplifiers save design time and external component count by integrating system solutions within the IC, translating into more cost reduction.

6 Current Limiting—Output Short to Supply

One feature of SPiKe Protection which can prevent costly mistakes from occurring in the lab when prototyping Overture audio amplifiers is its protection from output shorts to the supply rails. The device is protected from momentary shorts from the output to either supply rail by limiting the current flow through the output transistors.

Although accidents such as this one occur infrequently, accidents do happen and if one were to happen with Overture audio amplifiers they would be protected for a limited amount of time. Normally when an accident like this would occur in a discrete design with no current limiting protection, the output transistor would be subjected to the full output swing plus a large current draw from the supply. This type of stress would destroy an output stage discrete transistor whereas with SPiKe protected amplifiers, the current is internally limited, thus preventing its output transistors from being destroyed.

One note to make about this protection scheme is that the current limitation is not sustained indefinitely. In essence, the output shorts to either supply rail should not be sustained for any period of time greater than a few seconds. Frequent temporary shorts from the output to either supply rail will be protected, however, continued testing of the circuitry in this manner is not ensured and is likely to cause degradation to the functionality and long-term reliability of the device.

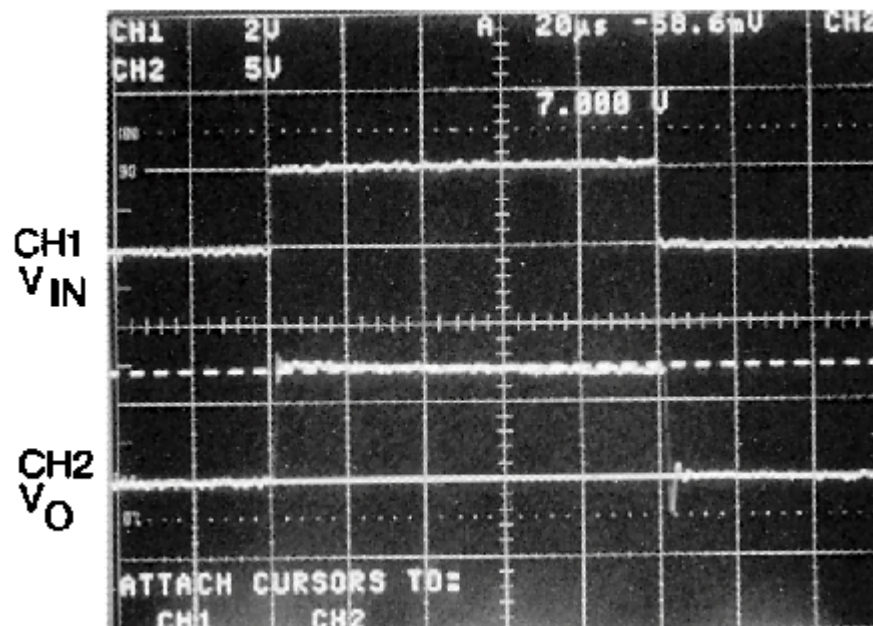

Figure 22. $t_w = 100 \mu\text{s}$, t_{SPiKe} (Not Enabled)

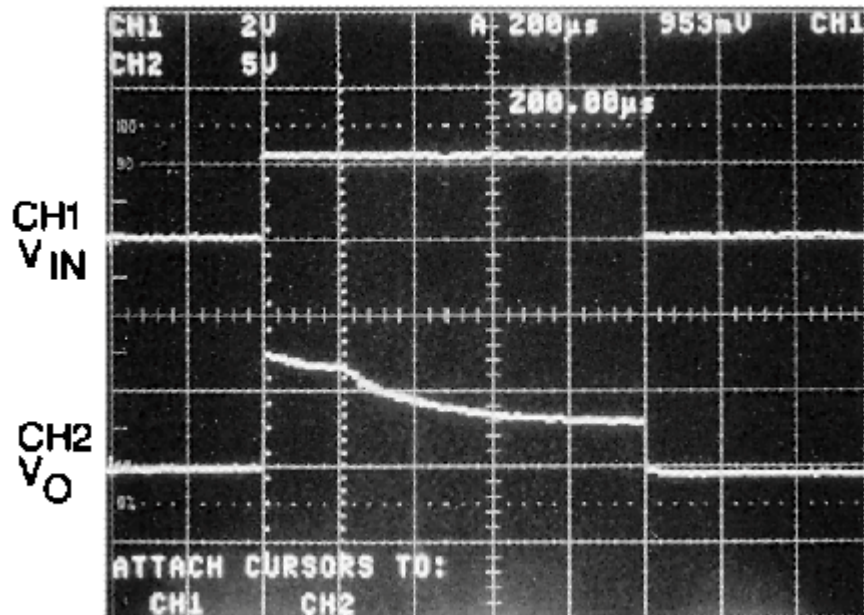

Figure 23. $t_w = 1 \text{ ms}$, $t_{\text{SPIKe}} = 200 \mu\text{s}$

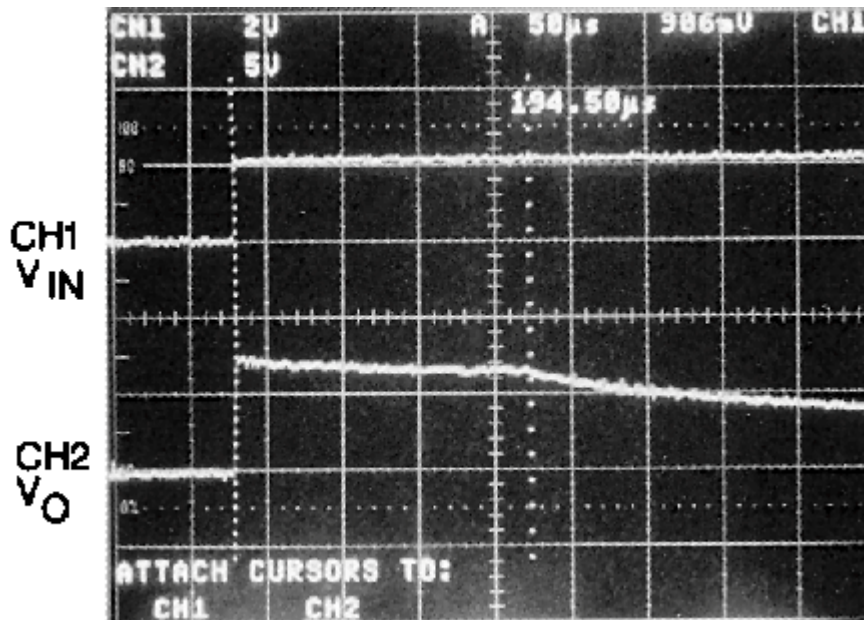

Figure 24. $t_w = 10 \text{ ms}$, $t_{\text{SPIKe}} = 195 \mu\text{s}$

7 Thermal Shutdown—Continuous Temperature Rise

An audio system designer's design cycle time is reduced by eliminating the need for designing tricky thermal matching between discrete output transistors and their biasing counterparts which are physically located some distance from each other. Complex thermal sensing and control circuitry provided from the legendary Bob Widlar, and the ability of integrating it onto a monolithic amplifier, eliminates the external circuitry and long design time required in a discrete amplifier design.

SPiKe protected audio amplifiers are safeguarded from Thermal runaway, an area of concern for any complementary-symmetry amplifier. Thermal runaway is an excessive amount of heating and power dissipation of the output transistor from an increased collector current caused by the two complementary transistors not having the same characteristics or from an uncompensated V_{BE} being reduced by high temperatures.

If proper heatsinking is not utilized, the die will heat up due to the poor dissipation of power when the amplifier is being driven hard for a long period of time. Once the die reaches its upper temperature limit of approximately 165°C, the thermal shutdown protection circuitry is enabled, driving the output to ground. A pseudo “pop” at the output may occur when this point is reached, due to the sudden interruption of the flow of music to the speaker. The device will remain off until the temperature of the die decreases about 10°C to its lower temperature limit of 155°C. It is at this point that the device will turn itself on, again amplifying the input signal.

As can be seen in [Figure 25](#) and [Figure 26](#), the junction temperature vs time graph and the response to the activation of the thermal shutdown circuitry perform in a Schmitt trigger fashion, turning the output on and off, thus regulating the temperature of the die over time when subjected to high continuous powers with improper heatsinking.

The intention of the protection circuitry is to prevent the device from being subjected to short-term fault conditions that result in high power dissipation within the amplifier and thus transgressing into thermal runaway. If the conditions that cause the thermal shutdown are not removed, the amplifier will perform in this Schmitt trigger fashion indefinitely, reducing the long-term reliability of the device.

The fairly slow-acting thermal shutdown circuitry is not intended to protect the amplifier against transient safe operating area violations. SPiKe protection circuitry will perform this function.

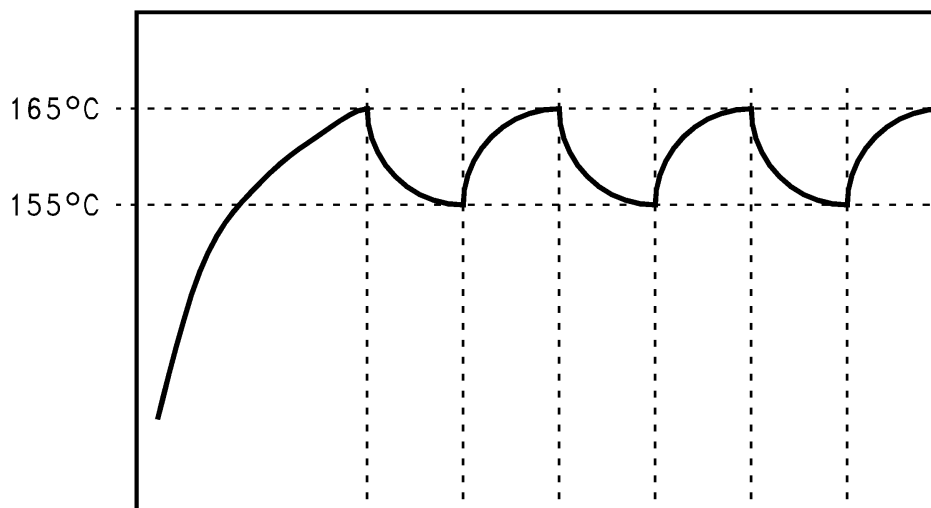

Figure 25. Junction Temperature vs Time

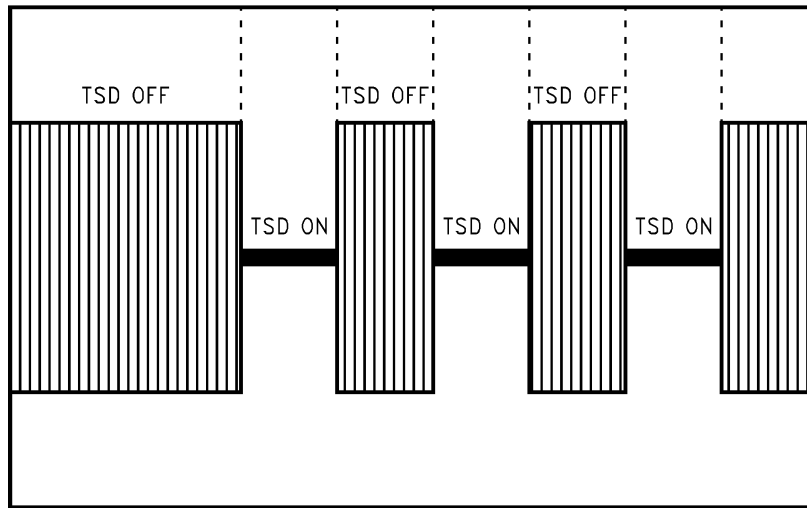

Figure 26. Thermal Shutdown Waveform

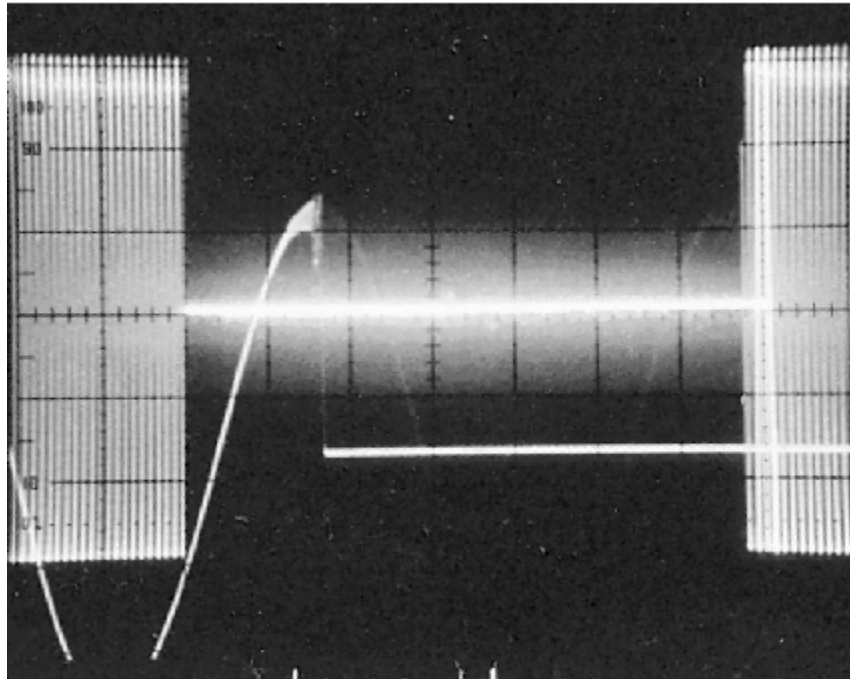

Figure 27. Actual Thermal Shutdown Waveform

IMPORTANT NOTICE

Texas Instruments Incorporated and its subsidiaries (TI) reserve the right to make corrections, enhancements, improvements and other changes to its semiconductor products and services per JESD46, latest issue, and to discontinue any product or service per JESD48, latest issue. Buyers should obtain the latest relevant information before placing orders and should verify that such information is current and complete. All semiconductor products (also referred to herein as "components") are sold subject to TI's terms and conditions of sale supplied at the time of order acknowledgment.

TI warrants performance of its components to the specifications applicable at the time of sale, in accordance with the warranty in TI's terms and conditions of sale of semiconductor products. Testing and other quality control techniques are used to the extent TI deems necessary to support this warranty. Except where mandated by applicable law, testing of all parameters of each component is not necessarily performed.

TI assumes no liability for applications assistance or the design of Buyers' products. Buyers are responsible for their products and applications using TI components. To minimize the risks associated with Buyers' products and applications, Buyers should provide adequate design and operating safeguards.

TI does not warrant or represent that any license, either express or implied, is granted under any patent right, copyright, mask work right, or other intellectual property right relating to any combination, machine, or process in which TI components or services are used. Information published by TI regarding third-party products or services does not constitute a license to use such products or services or a warranty or endorsement thereof. Use of such information may require a license from a third party under the patents or other intellectual property of the third party, or a license from TI under the patents or other intellectual property of TI.

Reproduction of significant portions of TI information in TI data books or data sheets is permissible only if reproduction is without alteration and is accompanied by all associated warranties, conditions, limitations, and notices. TI is not responsible or liable for such altered documentation. Information of third parties may be subject to additional restrictions.

Resale of TI components or services with statements different from or beyond the parameters stated by TI for that component or service voids all express and any implied warranties for the associated TI component or service and is an unfair and deceptive business practice. TI is not responsible or liable for any such statements.

Buyer acknowledges and agrees that it is solely responsible for compliance with all legal, regulatory and safety-related requirements concerning its products, and any use of TI components in its applications, notwithstanding any applications-related information or support that may be provided by TI. Buyer represents and agrees that it has all the necessary expertise to create and implement safeguards which anticipate dangerous consequences of failures, monitor failures and their consequences, lessen the likelihood of failures that might cause harm and take appropriate remedial actions. Buyer will fully indemnify TI and its representatives against any damages arising out of the use of any TI components in safety-critical applications.

In some cases, TI components may be promoted specifically to facilitate safety-related applications. With such components, TI's goal is to help enable customers to design and create their own end-product solutions that meet applicable functional safety standards and requirements. Nonetheless, such components are subject to these terms.

No TI components are authorized for use in FDA Class III (or similar life-critical medical equipment) unless authorized officers of the parties have executed a special agreement specifically governing such use.

Only those TI components which TI has specifically designated as military grade or "enhanced plastic" are designed and intended for use in military/aerospace applications or environments. Buyer acknowledges and agrees that any military or aerospace use of TI components which have **not** been so designated is solely at the Buyer's risk, and that Buyer is solely responsible for compliance with all legal and regulatory requirements in connection with such use.

TI has specifically designated certain components as meeting ISO/TS16949 requirements, mainly for automotive use. In any case of use of non-designated products, TI will not be responsible for any failure to meet ISO/TS16949.

Products

Audio	www.ti.com/audio
Amplifiers	amplifier.ti.com
Data Converters	dataconverter.ti.com
DLP® Products	www.dlp.com
DSP	dsp.ti.com
Clocks and Timers	www.ti.com/clocks
Interface	interface.ti.com
Logic	logic.ti.com
Power Mgmt	power.ti.com
Microcontrollers	microcontroller.ti.com
RFID	www.ti-rfid.com
OMAP Applications Processors	www.ti.com/omap
Wireless Connectivity	www.ti.com/wirelessconnectivity

Applications

Automotive and Transportation	www.ti.com/automotive
Communications and Telecom	www.ti.com/communications
Computers and Peripherals	www.ti.com/computers
Consumer Electronics	www.ti.com/consumer-apps
Energy and Lighting	www.ti.com/energy
Industrial	www.ti.com/industrial
Medical	www.ti.com/medical
Security	www.ti.com/security
Space, Avionics and Defense	www.ti.com/space-avionics-defense
Video and Imaging	www.ti.com/video

TI E2E Community

e2e.ti.com