

# LM4674 Boomer® Audio Power Amplifier Series **Filterless 2.5W Stereo Class D Audio Power Amplifier**

Check for Samples: [LM4674](#)

## FEATURES

- Output Short Circuit Protection
- Stereo Class D Operation
- No Output Filter Required
- Logic Selectable Gain
- Independent Shutdown Control
- Minimum External Components
- Click and Pop Suppression
- Micro-Power Shutdown
- Available in Space-Saving 2mm x 2mm x 0.6mm DSBGA, and 4mm x 4mm x 0.8mm WQFN Packages

## APPLICATIONS

- Mobile Phones
- PDAs
- Laptops

## KEY SPECIFICATIONS

- Efficiency at 3.6V, 100mW into 8Ω: 80% (typ)
- Efficiency at 3.6V, 500mW into 8Ω: 85% (typ)
- Efficiency at 5V, 1W into 8Ω: 85% (typ)
- Quiescent Power Supply Current at 3.6V supply: 4mA
- Power Output at  $V_{DD} = 5V$ ,  $R_L = 4\Omega$ , THD  $\leq 10\%$ : 2.5 W (typ)
- Shutdown Current: 0.03μA (typ)

## DESCRIPTION

The LM4674 is a single supply, high efficiency, 2.5W/channel, filterless switching audio amplifier. A low noise PWM architecture eliminates the output filter, reducing external component count, board area consumption, system cost, and simplifying design.

The LM4674 is designed to meet the demands of mobile phones and other portable communication devices. Operating from a single 5V supply, the device is capable of delivering 2.5W/channel of continuous output power to a 4Ω load with less than 10% THD+N. Flexible power supply requirements allow operation from 2.4V to 5.5V.

The LM4674 features high efficiency compared to conventional Class AB amplifiers. When driving an 8Ω speaker from a 3.6V supply, the device features 85% efficiency at  $P_O = 500mW$ . Four gain options are pin selectable through the G0 and G1 pins.

Output short circuit protection prevents the device from being damaged during fault conditions. Superior click and pop suppression eliminates audible transients on power-up/down and during shutdown. Independent left/right shutdown control maximizes power savings in mixed mono/stereo applications.



Please be aware that an important notice concerning availability, standard warranty, and use in critical applications of Texas Instruments semiconductor products and disclaimers thereto appears at the end of this data sheet.

All trademarks are the property of their respective owners.

## TYPICAL APPLICATION

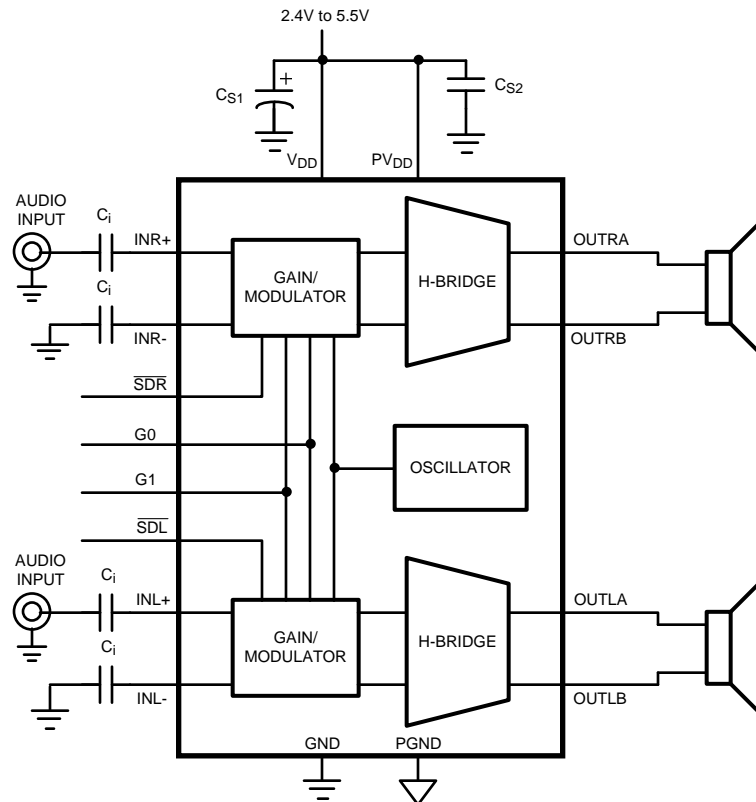

$C_i = 1 \mu\text{F}$   
 $C_{S1} = 1 \mu\text{F}$   
 $C_{S2} = 0.1 \mu\text{F}$

Figure 1. Typical Audio Amplifier Application Circuit

## EXTERNAL COMPONENTS DESCRIPTION

(Figure 1)

Components		Functional Description
1.	$C_S$	Supply bypass capacitor which provides power supply filtering. Refer to the <a href="#">AUDIO AMPLIFIER INPUT CAPACITOR SELECTION</a> section for information concerning proper placement and selection of the supply bypass capacitor.
2.	$C_i$	Input AC coupling capacitor which blocks the DC voltage at the amplifier's input terminals.

CONNECTION DIAGRAM

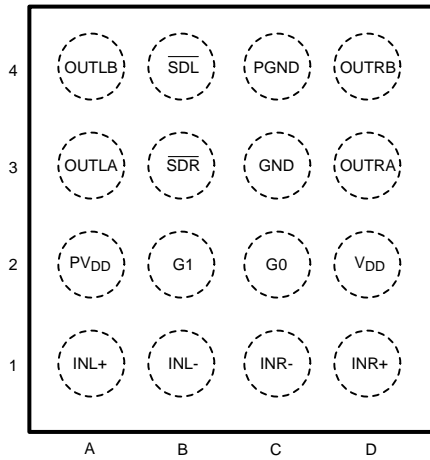

Figure 2. DSBGA (Top View)  
See YZR0016 Package

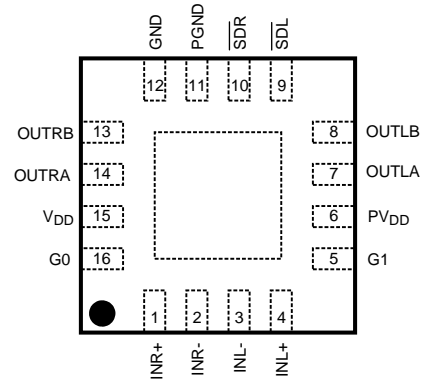

Figure 3. WQFN (Top View)  
See RGH0016A Package

**PIN DESCRIPTION**

<b>BUMP</b>	<b>PIN</b>	<b>NAME</b>	<b>FUNCTION</b>
A1	4	INL+	Non-inverting left channel input
A2	6	PV <sub>DD</sub>	Power V <sub>DD</sub>
A3	7	OUTLA	Left channel output A
A4	8	OUTLB	Left channel output B
B1	3	INL-	Inverting left channel input
B2	5	G1	Gain setting input 1
B3	10	$\overline{\text{SDR}}$	Right channel shutdown input
B4	9	$\overline{\text{SDL}}$	Left channel shutdown input
C1	2	INR-	Inverting right channel input
C2	16	G0	Gain setting input 0
C3	12	GND	Ground
C4	11	PGND	Power Ground
D1	1	INR+	Non-inverting right channel input
D2	15	V <sub>DD</sub>	Power Supply
D3	14	OUTRA	Right channel output A
D4	13	OUTRB	Right channel output B



These devices have limited built-in ESD protection. The leads should be shorted together or the device placed in conductive foam during storage or handling to prevent electrostatic damage to the MOS gates.

**ABSOLUTE MAXIMUM RATINGS<sup>(1)(2)</sup>**

Supply Voltage <sup>(1)</sup>		6.0V
Storage Temperature		-65°C to +150°C
Input Voltage		-0.3V to V <sub>DD</sub> + 0.3V
Power Dissipation <sup>(3)</sup>		Internally Limited
ESD Susceptibility, all other pins <sup>(4)</sup>		2000V
ESD Susceptibility <sup>(5)</sup>		200V
Junction Temperature (T <sub>JMAX</sub> )		150°C
Thermal Resistance	θ <sub>JA</sub> (DSBGA)	45.7°C/W
	θ <sub>JA</sub> (WQFN)	38.9°C/W

- (1) All voltages are measured with respect to the ground pin, unless otherwise specified.
- (2) Absolute Maximum Ratings indicate limits beyond which damage to the device may occur. Operating Ratings indicate conditions for which the device is functional, but do not ensure specific performance limits. Electrical Characteristics state DC and AC electrical specifications under particular test conditions which ensure specific performance limits. This assumes that the device is within the Operating Ratings. Specifications are not ensured for parameters where no limit is given, however, the typical value is a good indication of device performance.
- (3) The maximum power dissipation must be derated at elevated temperatures and is dictated by T<sub>JMAX</sub>, θ<sub>JA</sub>, and the ambient temperature, T<sub>A</sub>. The maximum allowable power dissipation is P<sub>DMAX</sub> = (T<sub>JMAX</sub> - T<sub>A</sub>) / θ<sub>JA</sub> or the number given in Absolute Maximum Ratings, whichever is lower. For the LM4674 see power derating currents for more information.
- (4) Human body model, 100pF discharged through a 1.5kΩ resistor.
- (5) Machine Model, 220pF–240pF discharged through all pins.

**OPERATING RATINGS<sup>(1)(2)</sup>**

Temperature Range (T <sub>MIN</sub> ≤ T <sub>A</sub> ≤ T <sub>MAX</sub> )	-40°C ≤ T <sub>A</sub> ≤ 85°C
Supply Voltage	2.4V ≤ V <sub>DD</sub> ≤ 5.5V

- (1) All voltages are measured with respect to the ground pin, unless otherwise specified.
- (2) Absolute Maximum Ratings indicate limits beyond which damage to the device may occur. Operating Ratings indicate conditions for which the device is functional, but do not ensure specific performance limits. Electrical Characteristics state DC and AC electrical specifications under particular test conditions which ensure specific performance limits. This assumes that the device is within the Operating Ratings. Specifications are not ensured for parameters where no limit is given, however, the typical value is a good indication of device performance.

**ELECTRICAL CHARACTERISTICS V<sub>DD</sub> = 3.6V<sup>(1)(2)</sup>**

The following specifications apply for A<sub>v</sub> = 6dB, R<sub>L</sub> = 15μH + 8Ω + 15μH, f = 1kHz unless otherwise specified. Limits apply for T<sub>A</sub> = 25°C.

Symbol	Parameter	Conditions	LM4674		Units (Limits)
			Typical <sup>(3)</sup>	Limit <sup>(4)(5)</sup>	
V <sub>OS</sub>	Differential Output Offset Voltage	V <sub>IN</sub> = 0, V <sub>DD</sub> = 2.4V to 5.0V	5		mV
I <sub>DD</sub>	Quiescent Power Supply Current	V <sub>IN</sub> = 0, R <sub>L</sub> = ∞, Both channels active, V <sub>DD</sub> = 3.6V	4	6	mA
		V <sub>IN</sub> = 0, R <sub>L</sub> = ∞, Both channels active, V <sub>DD</sub> = 5V	5	7.5	mA
I <sub>SD</sub>	Shutdown Current	V <sub>SDR</sub> = V <sub>SDL</sub> = GND	0.03	1	μA
V <sub>SDIH</sub>	Shutdown Voltage Input High			1.4	V (min)
V <sub>SDIL</sub>	Shutdown Voltage Input Low			0.4	V (max)
T <sub>WU</sub>	Wake Up Time	V <sub>SDR/SDL</sub> = 0.4V	0.5		ms

- (1) All voltages are measured with respect to the ground pin, unless otherwise specified.
- (2) Absolute Maximum Ratings indicate limits beyond which damage to the device may occur. Operating Ratings indicate conditions for which the device is functional, but do not ensure specific performance limits. Electrical Characteristics state DC and AC electrical specifications under particular test conditions which ensure specific performance limits. This assumes that the device is within the Operating Ratings. Specifications are not ensured for parameters where no limit is given, however, the typical value is a good indication of device performance.
- (3) Typicals are measured at 25°C and represent the parametric norm.
- (4) Limits are specified to AOQL (Average Outgoing Quality Level).
- (5) Datasheet min/max specification limits are specified by design, test, or statistical analysis.

**ELECTRICAL CHARACTERISTICS  $V_{DD} = 3.6V^{(1)(2)}$  (continued)**

The following specifications apply for  $A_V = 6dB$ ,  $R_L = 15\mu H + 8\Omega + 15\mu H$ ,  $f = 1kHz$  unless otherwise specified. Limits apply for  $T_A = 25^\circ C$ .

Symbol	Parameter	Conditions	LM4674		Units (Limits)
			Typical <sup>(3)</sup>	Limit <sup>(4)(5)</sup>	
$A_V$	Gain	$G_0, G_1 = GND$ $R_L = \infty$	6	$6 \pm 0.5$	dB
		$G_0 = V_{DD}, G_1 = GND$ $R_L = \infty$	12	$12 \pm 0.5$	dB
		$G_0 = GND, G_1 = V_{DD}$ $R_L = \infty$	18	$18 \pm 0.5$	dB
		$G_0, G_1 = V_{DD}$ $R_L = \infty$	24	$24 \pm 0.5$	dB
$R_{IN}$	Input Resistance	$A_V = 6dB$	28		k $\Omega$
		$A_V = 12dB$	18.75		k $\Omega$
		$A_V = 18dB$	11.25		k $\Omega$
		$A_V = 24dB$	6.25		k $\Omega$
$P_O$	Output Power	$R_L = 15\mu H + 4\Omega + 15\mu H$ , THD $\leq 10\%$ $f = 1kHz$ , 22kHz BW			
		$V_{DD} = 5V$	2.5		W
		$V_{DD} = 3.6V$	1.2		W
		$V_{DD} = 2.5V$	0.530		W
		$R_L = 15\mu H + 8\Omega + 15\mu H$ , THD $\leq 10\%$ $f = 1kHz$ , 22kHz BW			
		$V_{DD} = 5V$	1.5		W
		$V_{DD} = 3.6V$	0.78	0.6	W
		$V_{DD} = 2.5V$	0.350		W
		$R_L = 15\mu H + 4\Omega + 15\mu H$ , THD $\leq 1\%$ $f = 1kHz$ , 22kHz BW			
		$V_{DD} = 5V$	1.9		W
		$V_{DD} = 3.6V$	1		W
		$V_{DD} = 2.5V$	0.430		W
		$R_L = 15\mu H + 8\Omega + 15\mu H$ , THD = 1% $f = 1kHz$ , 22kHz BW			
		$V_{DD} = 5V$	1.25		W
		$V_{DD} = 3.6V$	0.63		W
		$V_{DD} = 2.5V$	0.285		W
THD+N	Total Harmonic Distortion	$P_O = 500mW$ , $f = 1kHz$ , $R_L = 8\Omega$	0.07		%
		$P_O = 300mW$ , $f = 1kHz$ , $R_L = 8\Omega$	0.05		%
PSRR	Power Supply Rejection Ratio	$V_{RIPPLE} = 200mV_{P-P}$ Sine, $f_{RIPPLE} = 217Hz$ , Inputs AC GND, $C_i = 1\mu F$ , input referred	75		dB
		$V_{RIPPLE} = 1V_{P-P}$ Sine, $f_{RIPPLE} = 1kHz$ , Inputs AC GND, $C_i = 1\mu F$ , input referred	75		dB
CMRR	Common Mode Rejection Ratio	$V_{RIPPLE} = 1V_{P-P}$ $f_{RIPPLE} = 217Hz$	67		dB
$\eta$	Efficiency	$P_O = 1W$ , $f = 1kHz$ , $R_L = 8\Omega$ , $V_{DD} = 5V$	85		%
Xtalk	Crosstalk	$P_O = 500mW$ , $f = 1kHz$	84		dB
SNR	Signal to Noise Ratio	$V_{DD} = 5V$ , $P_O = 1W$	96		dB
$\epsilon_{OS}$	Output Noise	Input referred, A-Weighted Filter	20		$\mu V$

**BLOCK DIAGRAMS**

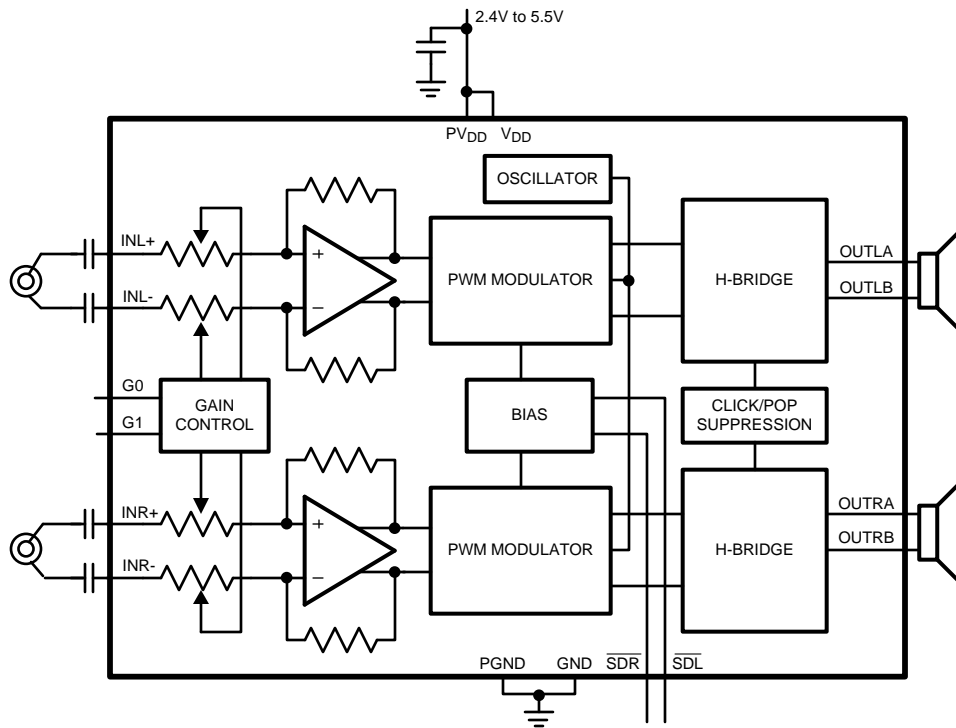

**Figure 4. Differential Input Configuration**

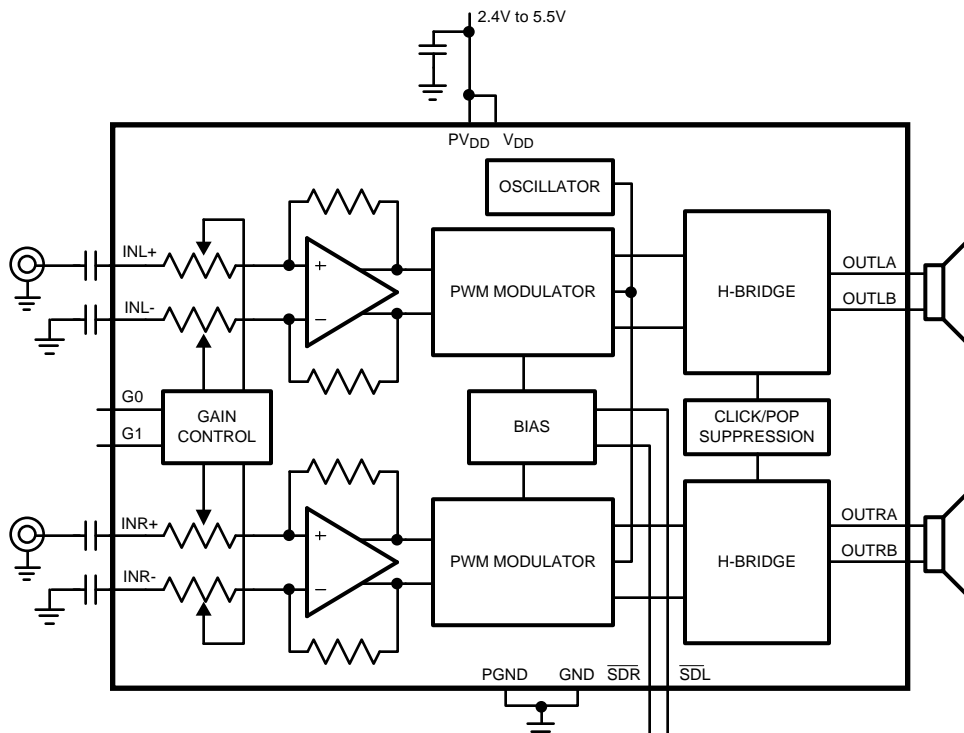

**Figure 5. Single-Ended Input Configuration**

**TYPICAL PERFORMANCE CHARACTERISTICS**

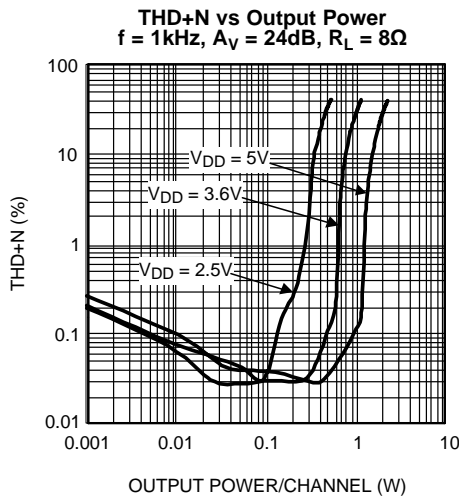

Figure 6.

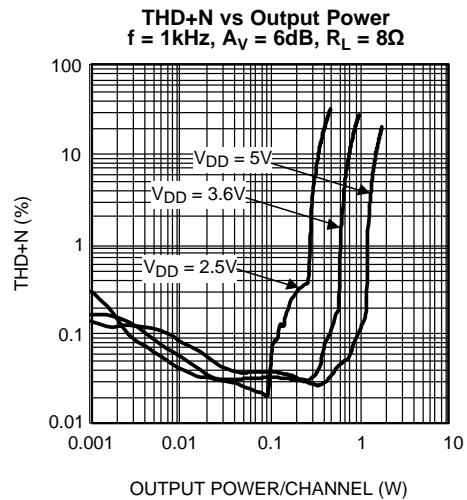

Figure 7.

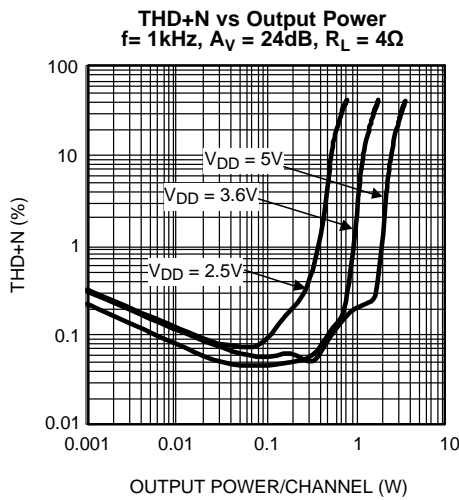

Figure 8.

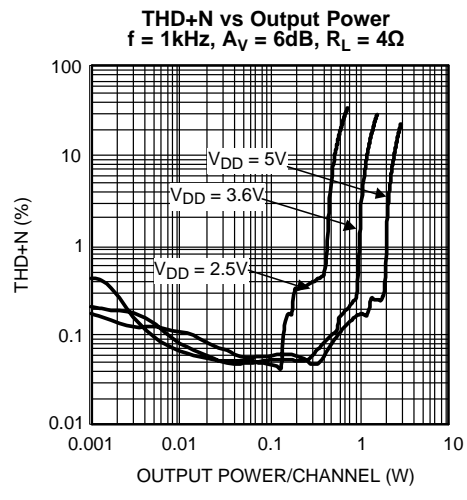

Figure 9.

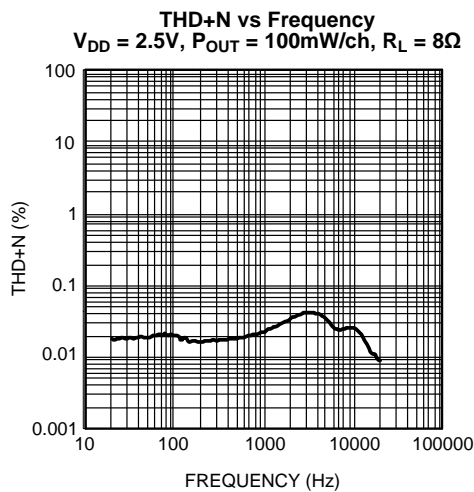

Figure 10.

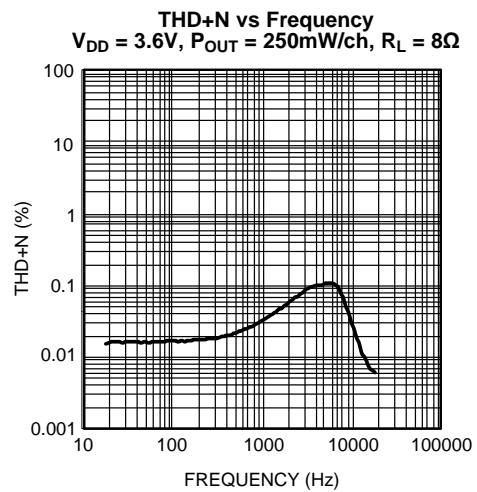

Figure 11.



**TYPICAL PERFORMANCE CHARACTERISTICS (continued)**

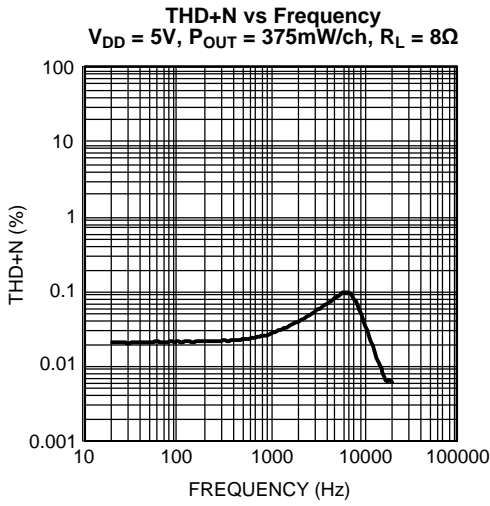

Figure 12.

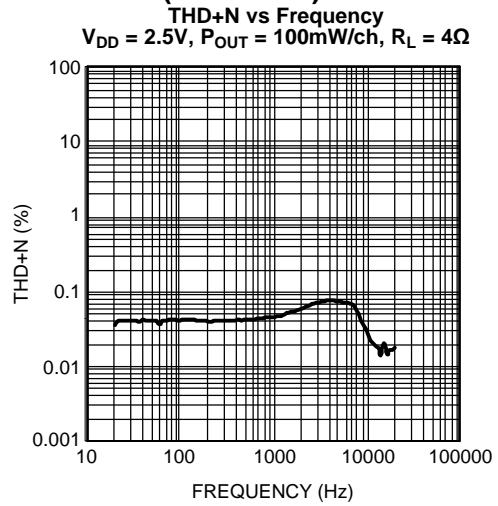

Figure 13.

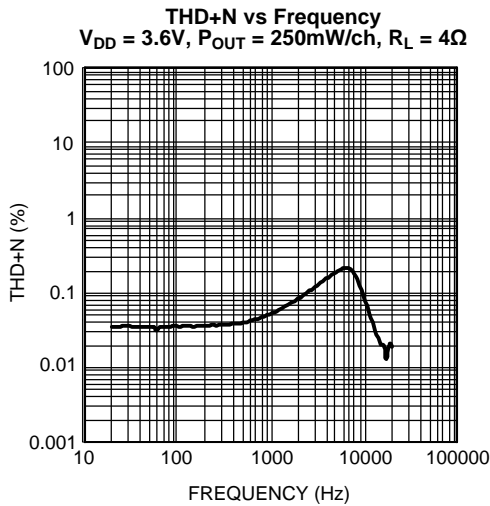

Figure 14.

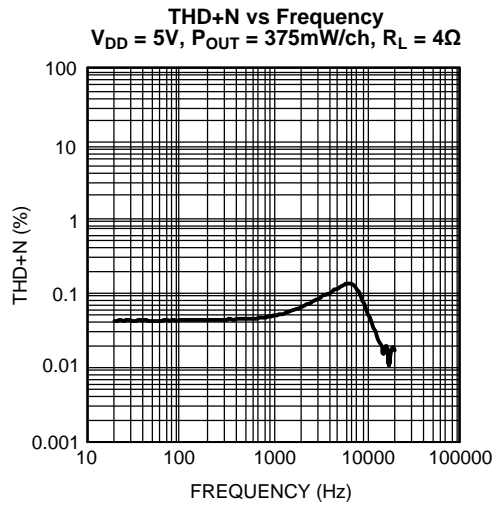

Figure 15.

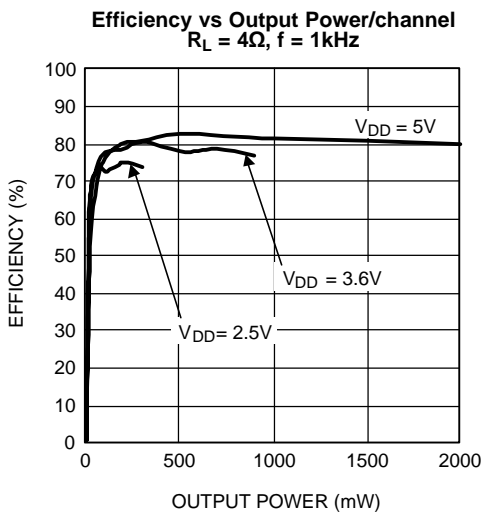

Figure 16.

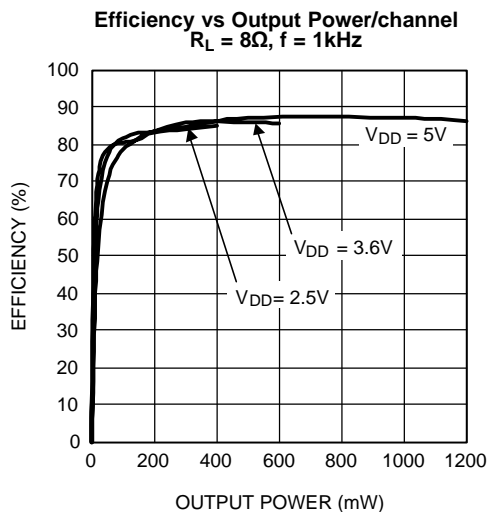

Figure 17.

**TYPICAL PERFORMANCE CHARACTERISTICS (continued)**

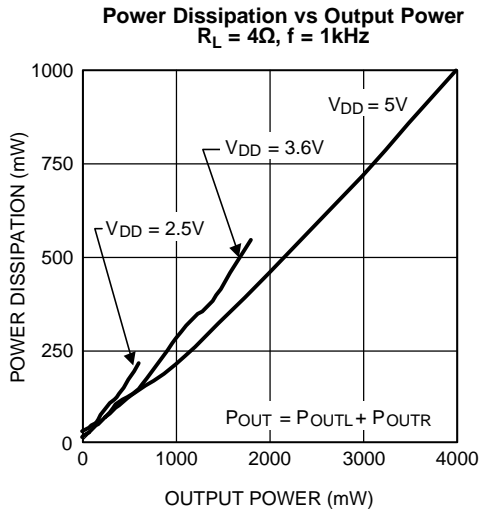

Figure 18.

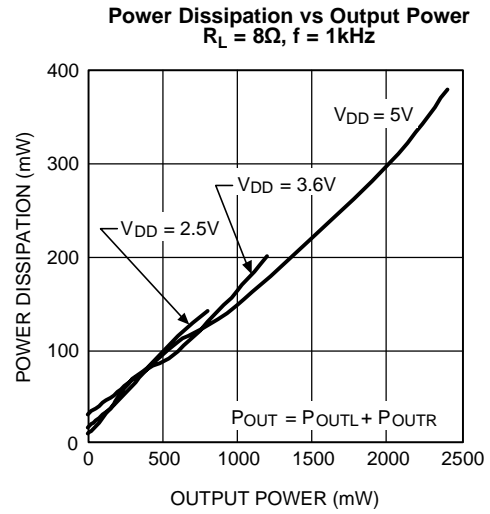

Figure 19.

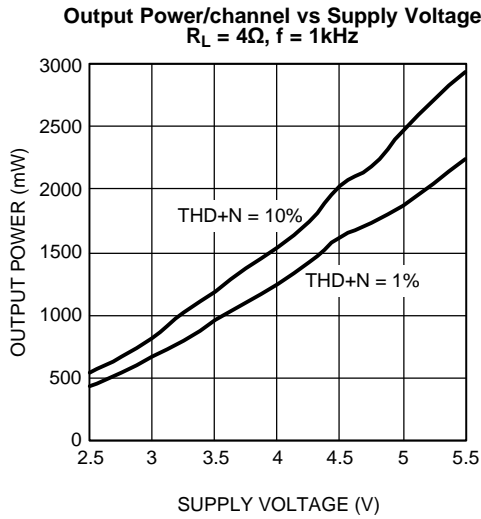

Figure 20.

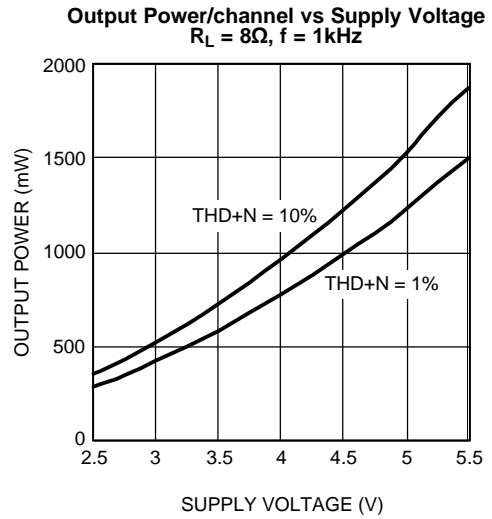

Figure 21.

**TYPICAL PERFORMANCE CHARACTERISTICS (continued)**

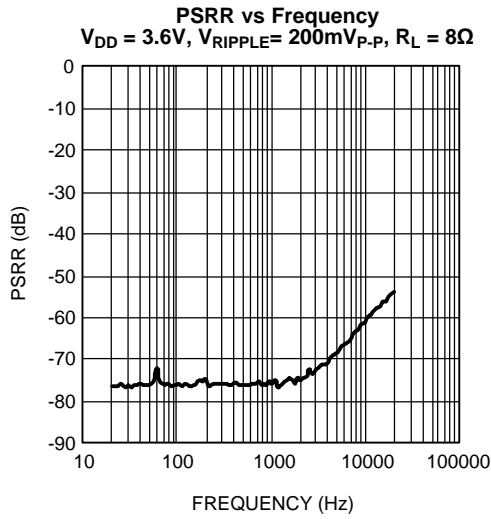

Figure 22.

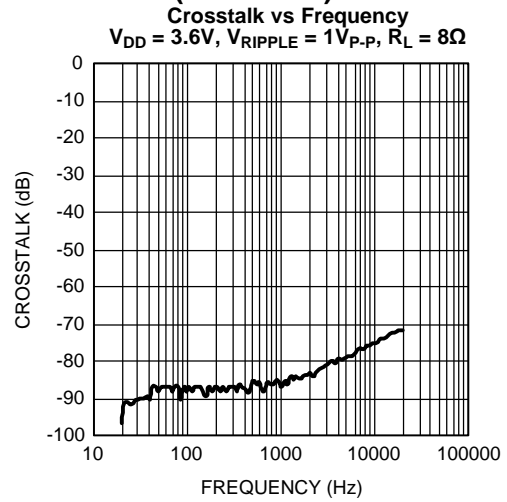

Figure 23.

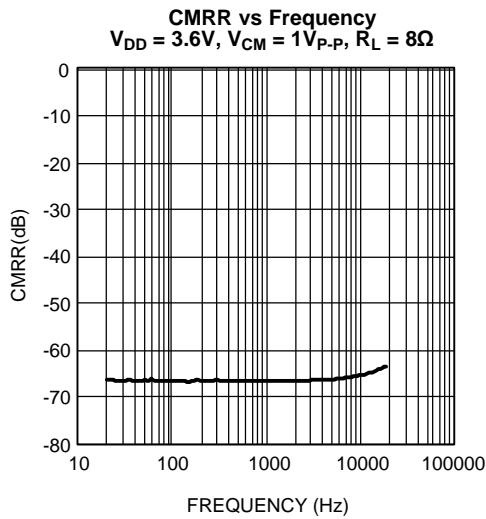

Figure 24.

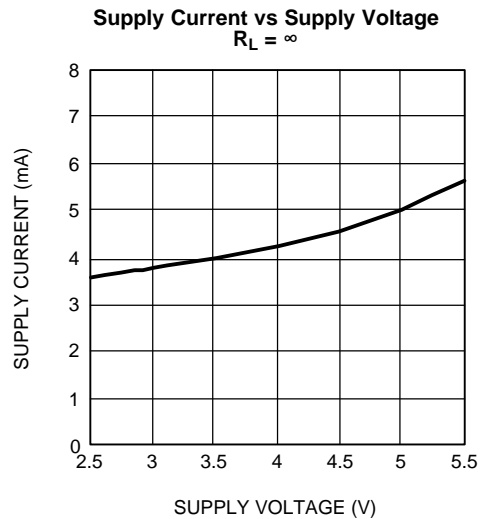

Figure 25.

## APPLICATION INFORMATION

### GENERAL AMPLIFIER FUNCTION

The LM4674 stereo Class D audio power amplifier features a filterless modulation scheme that reduces external component count, conserving board space and reducing system cost. The outputs of the device transition from  $V_{DD}$  to GND with a 300kHz switching frequency. With no signal applied, the outputs for each channel switch with a 50% duty cycle, in phase, causing the two outputs to cancel. This cancellation results in no net voltage across the speaker, thus there is no current to the load in the idle state.

With the input signal applied, the duty cycle (pulse width) of the LM4674 outputs changes. For increasing output voltage, the duty cycle of the A output increases, while the duty cycle of the B output decreases for each channel. For decreasing output voltages, the converse occurs. The difference between the two pulse widths yields the differential output voltage.

### DIFFERENTIAL AMPLIFIER EXPLANATION

As logic supplies continue to shrink, system designers are increasingly turning to differential analog signal handling to preserve signal to noise ratios with restricted voltage signs. The LM4674 features two fully differential amplifiers. A differential amplifier amplifies the difference between the two input signals. Traditional audio power amplifiers have typically offered only single-ended inputs resulting in a 6dB reduction of SNR relative to differential inputs. The LM4674 also offers the possibility of DC input coupling which eliminates the input coupling capacitors. A major benefit of the fully differential amplifier is the improved common mode rejection ratio (CMRR) over single ended input amplifiers. The increased CMRR of the differential amplifier reduces sensitivity to ground offset related noise injection, especially important in noisy systems.

### POWER DISSIPATION AND EFFICIENCY

The major benefit of a Class D amplifier is increased efficiency versus a class AB amplifier. The efficiency of the LM4674 is attributed to the region of operation of the transistors in the output stage. The Class D output stage acts as current steering switches, consuming negligible amounts of power compared to their Class AB counterparts. Most of the power loss associated with the output stage is due to the IR loss of the MOSFET on-resistance ( $R_{DS(ON)}$ ), along with switching losses due to gate charge.

### SHUTDOWN FUNCTION

The LM4674 features independent left and right channel shutdown controls, allowing each channel to be disabled independently.  $\overline{SDR}$  controls the right channel, while  $\overline{SDL}$  controls the left channel. Driving either low disables the corresponding channel.

It is best to switch between ground and  $V_{DD}$  for minimum current consumption while in shutdown. The LM4674 may be disabled with shutdown voltages in between GND and  $V_{DD}$ , the idle current will be greater than the typical 0.03 $\mu$ A value. For logic levels between GND and  $V_{DD}$  bypass  $\overline{SD}_-$  with a 0.1 $\mu$ F capacitor.

The LM4674 shutdown inputs have internal pulldown resistors. The purpose of these resistors is to eliminate any unwanted state changes when  $\overline{SD}_-$  is floating. To minimize shutdown current,  $\overline{SD}_-$  should be driven to GND or left floating. If  $\overline{SD}_-$  is not driven to GND or floating, an increase in shutdown supply current will be noticed.

### SINGLE-ENDED AUDIO AMPLIFIER CONFIGURATION

The LM4674 is compatible with single-ended sources. When configured for single-ended inputs, input capacitors must be used to block any DC component at the input of the device. [Figure 5](#) shows the typical single-ended applications circuit.

### AUDIO AMPLIFIER POWER SUPPLY BYPASSING/FILTERING

Proper power supply bypassing is critical for low noise performance and high PSRR. Place the supply bypass capacitor as close to the device as possible. Typical applications employ a voltage regulator with 10 $\mu$ F and 0.1 $\mu$ F bypass capacitors that increase supply stability. These capacitors do not eliminate the need for bypassing of the LM4674 supply pins. A 1 $\mu$ F capacitor is recommended.

## AUDIO AMPLIFIER INPUT CAPACITOR SELECTION

Input capacitors may be required for some applications, or when the audio source is single-ended. Input capacitors block the DC component of the audio signal, eliminating any conflict between the DC component of the audio source and the bias voltage of the LM4674. The input capacitors create a high-pass filter with the input resistance  $R_i$ . The -3dB point of the high pass filter is found using [Equation \(1\)](#) below.

$$f = 1 / 2\pi R_i C_i \quad (1)$$

The values for  $R_i$  can be found in the EC table for each gain setting.

The input capacitors can also be used to remove low frequency content from the audio signal. Small speakers cannot reproduce, and may even be damaged by low frequencies. High pass filtering the audio signal helps protect the speakers. When the LM4674 is using a single-ended source, power supply noise on the ground is seen as an input signal. Setting the high-pass filter point above the power supply noise frequencies, 217 Hz in a GSM phone, for example, filters out the noise such that it is not amplified and heard on the output. Capacitors with a tolerance of 10% or better are recommended for impedance matching and improved CMRR and PSRR.

## AUDIO AMPLIFIER GAIN SETTING

The LM4674 features four internally configured gain settings. The device gain is selected through the two logic inputs, G0 and G1. The gain settings are as shown in the following table.

LOGIC INPUT		GAIN	
G1	G0	V/V	dB
0	0	2	6
0	1	4	12
1	0	8	18
1	1	16	24

## PCB LAYOUT GUIDELINES

As output power increases, interconnect resistance (PCB traces and wires) between the amplifier, load and power supply create a voltage drop. The voltage loss due to the traces between the LM4674 and the load results in lower output power and decreased efficiency. Higher trace resistance between the supply and the LM4674 has the same effect as a poorly regulated supply, increasing ripple on the supply line, and reducing peak output power. The effects of residual trace resistance increases as output current increases due to higher output power, decreased load impedance or both. To maintain the highest output voltage swing and corresponding peak output power, the PCB traces that connect the output pins to the load and the supply pins to the power supply should be as wide as possible to minimize trace resistance.

The use of power and ground planes will give the best THD+N performance. In addition to reducing trace resistance, the use of power planes creates parasitic capacitors that help to filter the power supply line.

The inductive nature of the transducer load can also result in overshoot on one or both edges, clamped by the parasitic diodes to GND and VDD in each case. From an EMI standpoint, this is an aggressive waveform that can radiate or conduct to other components in the system and cause interference. It is essential to keep the power and output traces short and well shielded if possible. Use of ground planes beads and micro-strip layout techniques are all useful in preventing unwanted interference.

As the distance from the LM4674 and the speaker increases, the amount of EMI radiation increases due to the output wires or traces acting as antennas become more efficient with length. Ferrite chip inductors placed close to the LM4674 outputs may be needed to reduce EMI radiation.

### LM4674TL DEMO BOARD SCHEMATIC

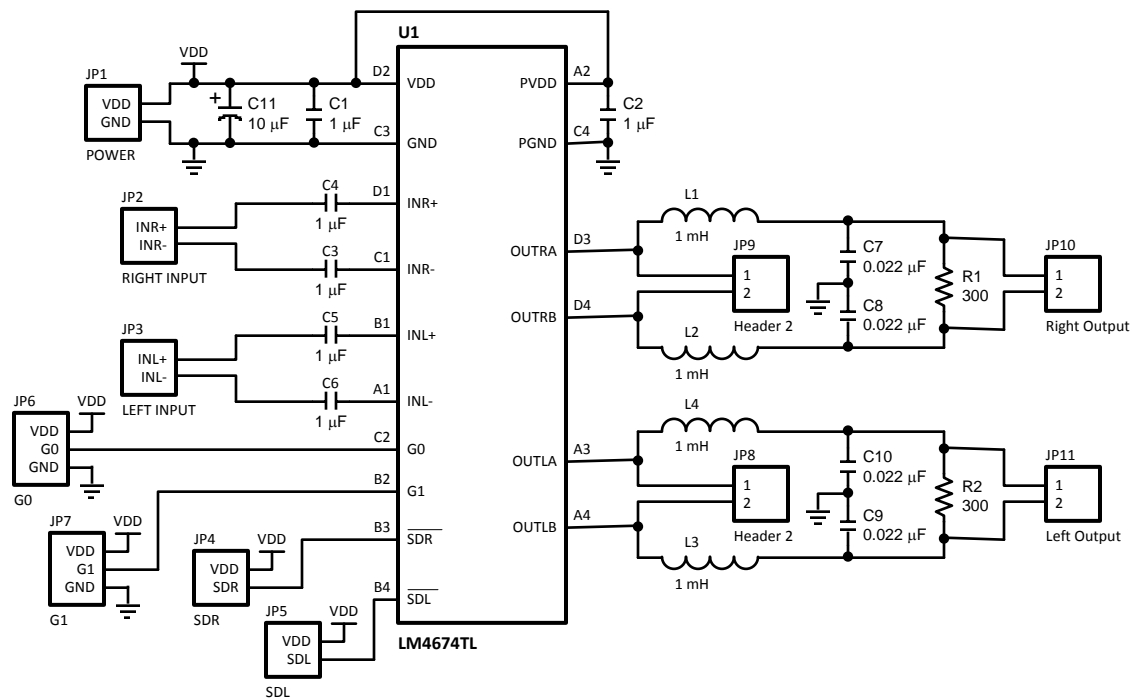

Figure 26. LM4674TL Demo Board Schematic

### LM4674TL DEMONSTRATION BOARD LAYOUT

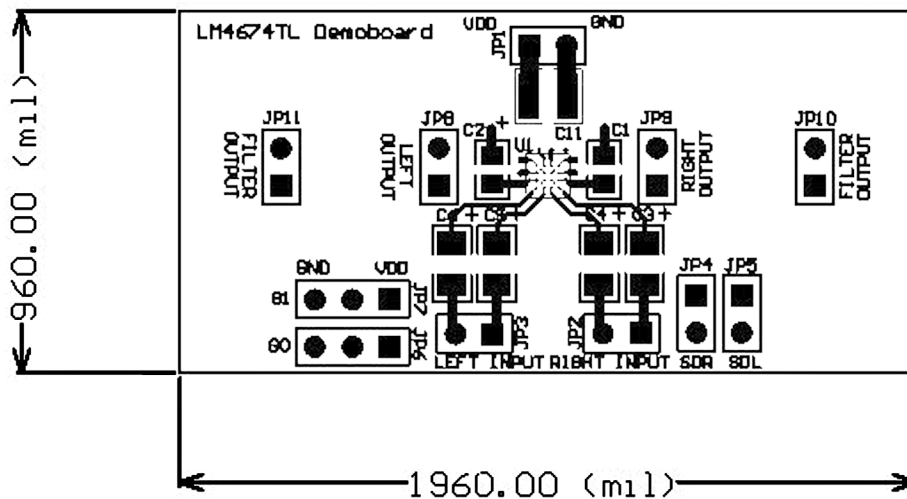

Figure 27. Layer 1

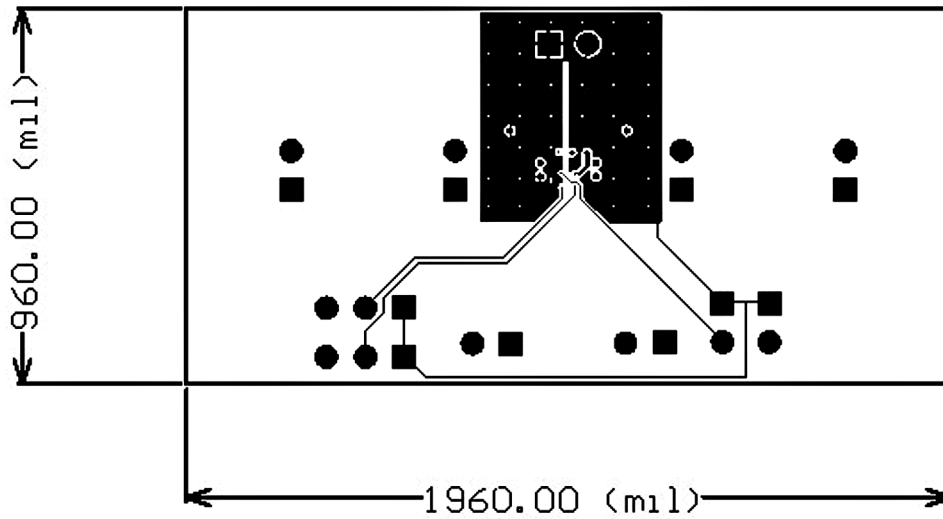

Figure 28. Layer 2

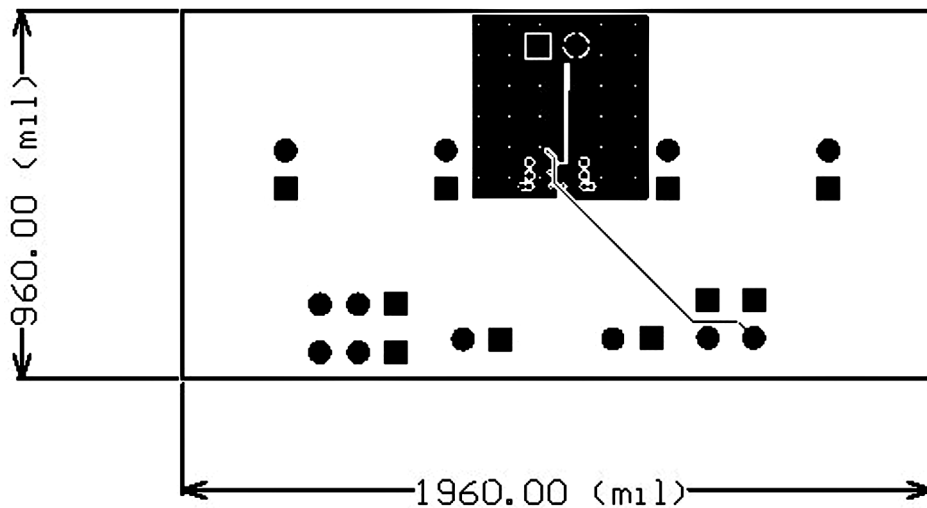

Figure 29. Layer 3

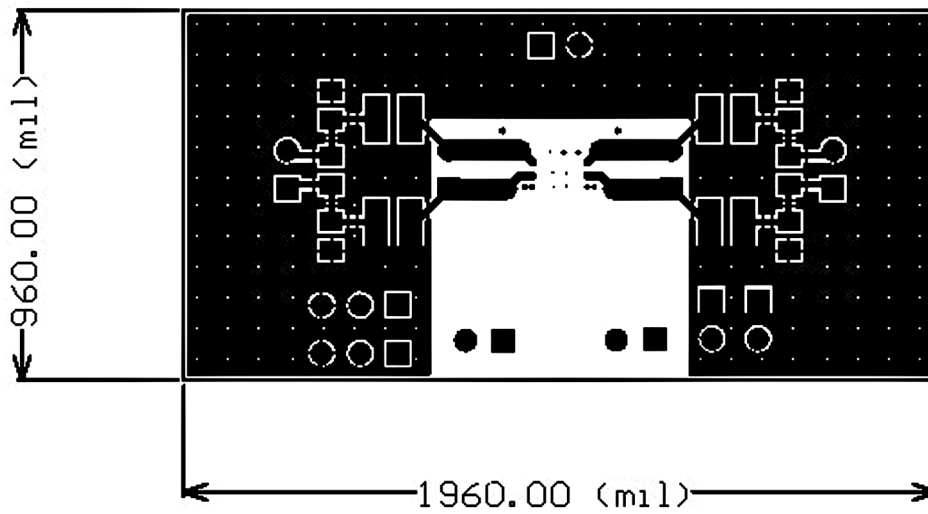

Figure 30. Layer 4

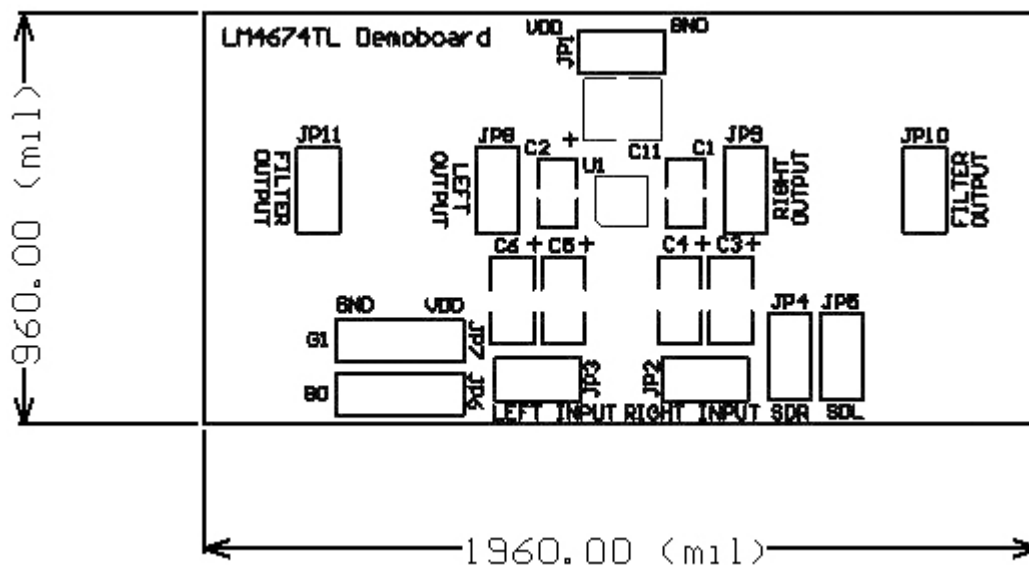

Figure 31. Top Silkscreen



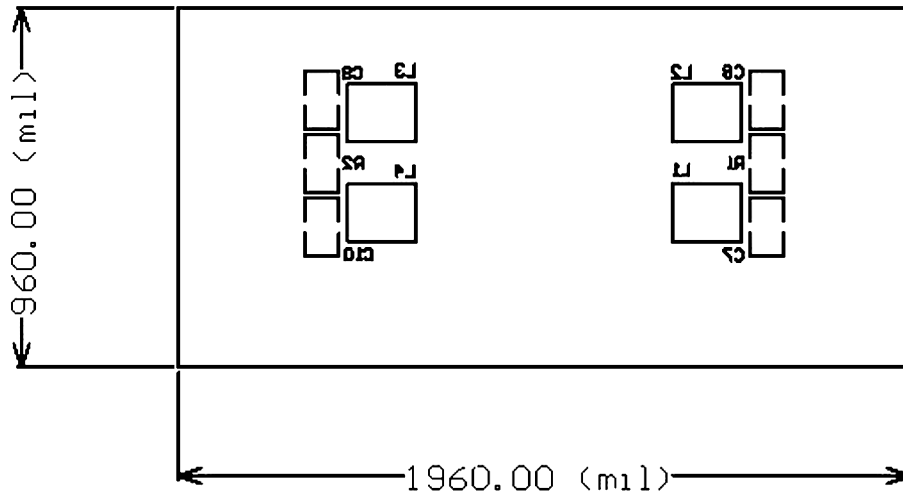

Figure 32. Bottom Silkscreen

LM4674SQ DEMO BOARD SCHEMATIC

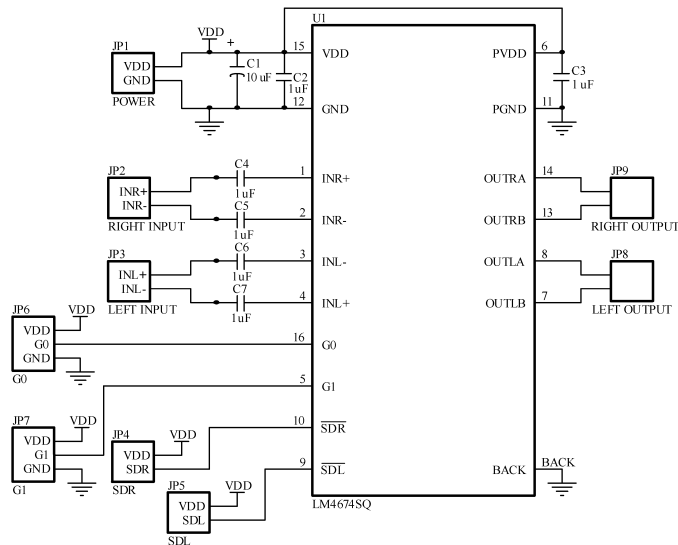
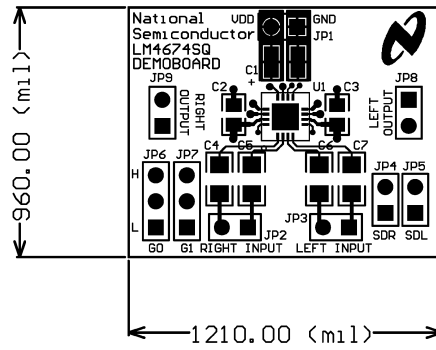
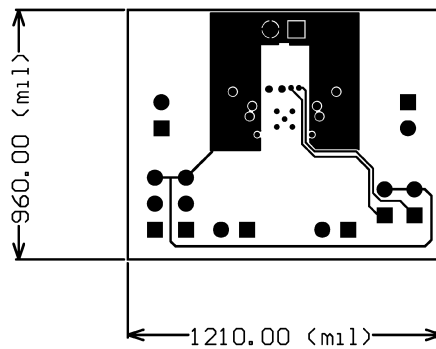

Figure 33. LM4674SQ Demo Board Schematic

**LM4674SQ DEMONSTRATION BOARD LAYOUT**



**Figure 34. Layer 1**



**Figure 35. Layer 2**

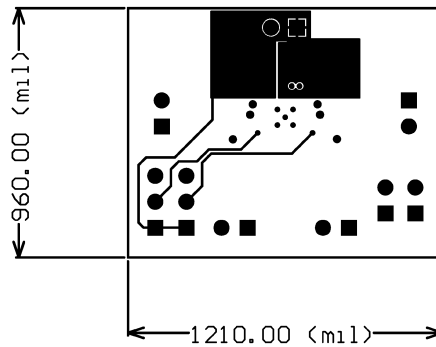

**Figure 36. Layer 3**

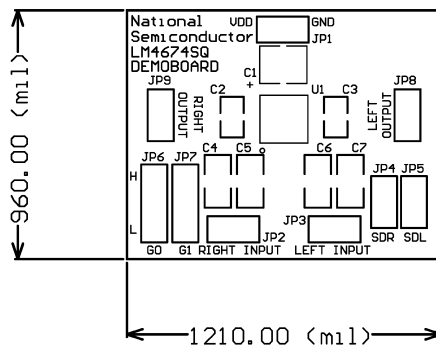

Figure 37. Top Silkscreen

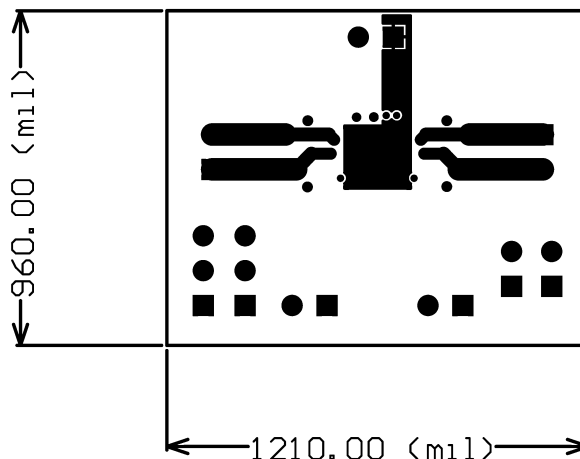

Figure 38. Bottom Layer

REVISION TABLE

Rev	Date	Description
1.0	12/16/06	Initial release.
1.1	05/17/06	Added the LLP package.
1.2	05/31/06	Added the LLP markings.
1.3	09/05/06	Added "No Load" in the Conditions on Av (3.6V table).
1.4	09/21/06	Edited graphics (26, 38, 60) and input some text edits.
1.5	09/27/06	Edited Figure 1 (page 2), TL and LLP pkg/marking drawings (page 3). Input text edits.
1.6	07/13/07	Added the TL and SQ demo boards and schematics diagrams.
1.7	10/30/07	Updated the SQ schematic diagram and replaced the demo boards.
1.8	07/02/08	Text edits (under SHUTDOWN FUNCTION).
E	04/05/13	Changed layout of National Data Sheet to TI format.

**PACKAGING INFORMATION**

Orderable Device	Status (1)	Package Type	Package Drawing	Pins	Package Qty	Eco Plan (2)	Lead finish/ Ball material (6)	MSL Peak Temp (3)	Op Temp (°C)	Device Marking (4/5)	Samples
LM4674SQ/NOPB	ACTIVE	WQFN	RGH	16	1000	RoHS & Green	SN	Level-1-260C-UNLIM	-40 to 85	L4674SQ	<b>Samples</b>
LM4674TLX/NOPB	ACTIVE	DSBGA	YZR	16	3000	RoHS & Green	SNAGCU	Level-1-260C-UNLIM	-40 to 85	GG2	<b>Samples</b>

(1) The marketing status values are defined as follows:

**ACTIVE:** Product device recommended for new designs.

**LIFEBUY:** TI has announced that the device will be discontinued, and a lifetime-buy period is in effect.

**NRND:** Not recommended for new designs. Device is in production to support existing customers, but TI does not recommend using this part in a new design.

**PREVIEW:** Device has been announced but is not in production. Samples may or may not be available.

**OBSOLETE:** TI has discontinued the production of the device.

(2) **RoHS:** TI defines "RoHS" to mean semiconductor products that are compliant with the current EU RoHS requirements for all 10 RoHS substances, including the requirement that RoHS substance do not exceed 0.1% by weight in homogeneous materials. Where designed to be soldered at high temperatures, "RoHS" products are suitable for use in specified lead-free processes. TI may reference these types of products as "Pb-Free".

**RoHS Exempt:** TI defines "RoHS Exempt" to mean products that contain lead but are compliant with EU RoHS pursuant to a specific EU RoHS exemption.

**Green:** TI defines "Green" to mean the content of Chlorine (Cl) and Bromine (Br) based flame retardants meet JS709B low halogen requirements of <=1000ppm threshold. Antimony trioxide based flame retardants must also meet the <=1000ppm threshold requirement.

(3) MSL, Peak Temp. - The Moisture Sensitivity Level rating according to the JEDEC industry standard classifications, and peak solder temperature.

(4) There may be additional marking, which relates to the logo, the lot trace code information, or the environmental category on the device.

(5) Multiple Device Markings will be inside parentheses. Only one Device Marking contained in parentheses and separated by a "~" will appear on a device. If a line is indented then it is a continuation of the previous line and the two combined represent the entire Device Marking for that device.

(6) Lead finish/Ball material - Orderable Devices may have multiple material finish options. Finish options are separated by a vertical ruled line. Lead finish/Ball material values may wrap to two lines if the finish value exceeds the maximum column width.

**Important Information and Disclaimer:**The information provided on this page represents TI's knowledge and belief as of the date that it is provided. TI bases its knowledge and belief on information provided by third parties, and makes no representation or warranty as to the accuracy of such information. Efforts are underway to better integrate information from third parties. TI has taken and continues to take reasonable steps to provide representative and accurate information but may not have conducted destructive testing or chemical analysis on incoming materials and chemicals. TI and TI suppliers consider certain information to be proprietary, and thus CAS numbers and other limited information may not be available for release.

In no event shall TI's liability arising out of such information exceed the total purchase price of the TI part(s) at issue in this document sold by TI to Customer on an annual basis.



**TAPE AND REEL INFORMATION**

**QUADRANT ASSIGNMENTS FOR PIN 1 ORIENTATION IN TAPE**



\*All dimensions are nominal

Device	Package Type	Package Drawing	Pins	SPQ	Reel Diameter (mm)	Reel Width W1 (mm)	A0 (mm)	B0 (mm)	K0 (mm)	P1 (mm)	W (mm)	Pin1 Quadrant
LM4674SQ/NOPB	WQFN	RGH	16	1000	178.0	12.4	4.3	4.3	1.3	8.0	12.0	Q1
LM4674TLX/NOPB	DSBGA	YZR	16	3000	178.0	8.4	2.08	2.08	0.76	4.0	8.0	Q1

**TAPE AND REEL BOX DIMENSIONS**

\*All dimensions are nominal

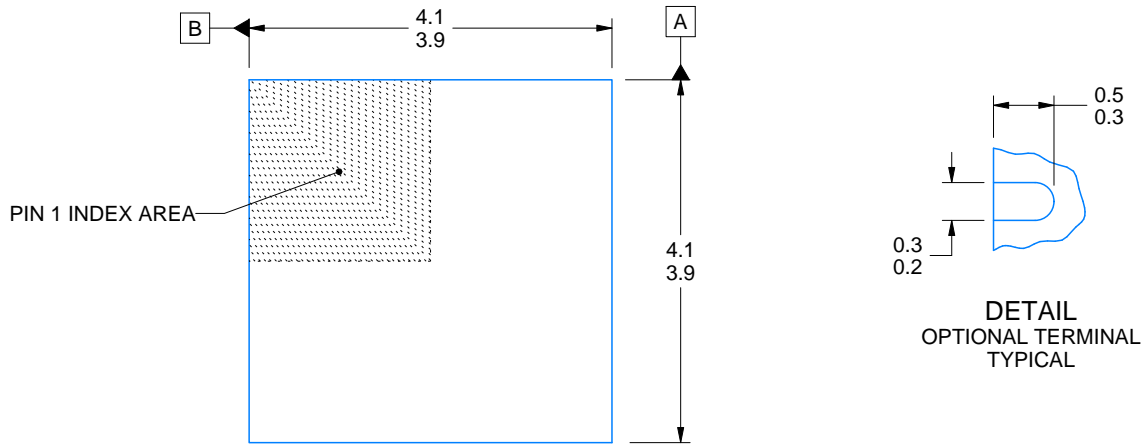
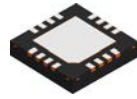
Device	Package Type	Package Drawing	Pins	SPQ	Length (mm)	Width (mm)	Height (mm)
LM4674SQ/NOPB	WQFN	RGH	16	1000	208.0	191.0	35.0
LM4674TLX/NOPB	DSBGA	YZR	16	3000	208.0	191.0	35.0



DIM A	
OPT 1	OPT 1
(0.1)	(0.2)

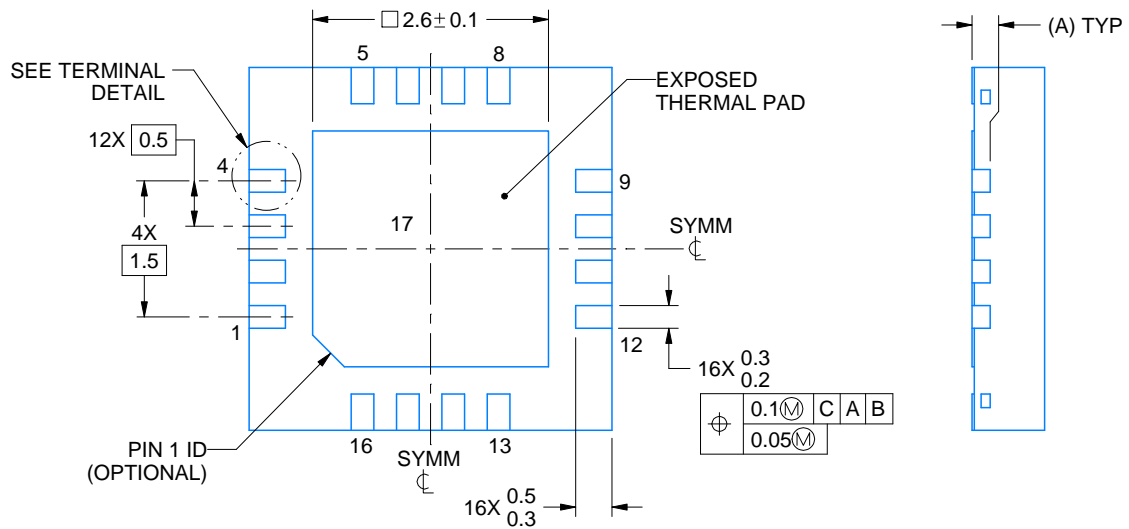
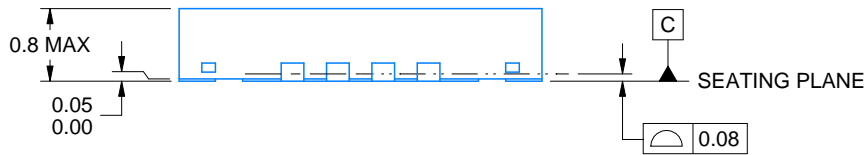

4214978/B 01/2017

NOTES:

1. All linear dimensions are in millimeters. Any dimensions in parenthesis are for reference only. Dimensioning and tolerancing per ASME Y14.5M.
2. This drawing is subject to change without notice.
3. The package thermal pad must be soldered to the printed circuit board for optimal thermal and mechanical performance.



# EXAMPLE BOARD LAYOUT

RGH0016A

WQFN - 0.8 mm max height

PLASTIC QUAD FLATPACK - NO LEAD

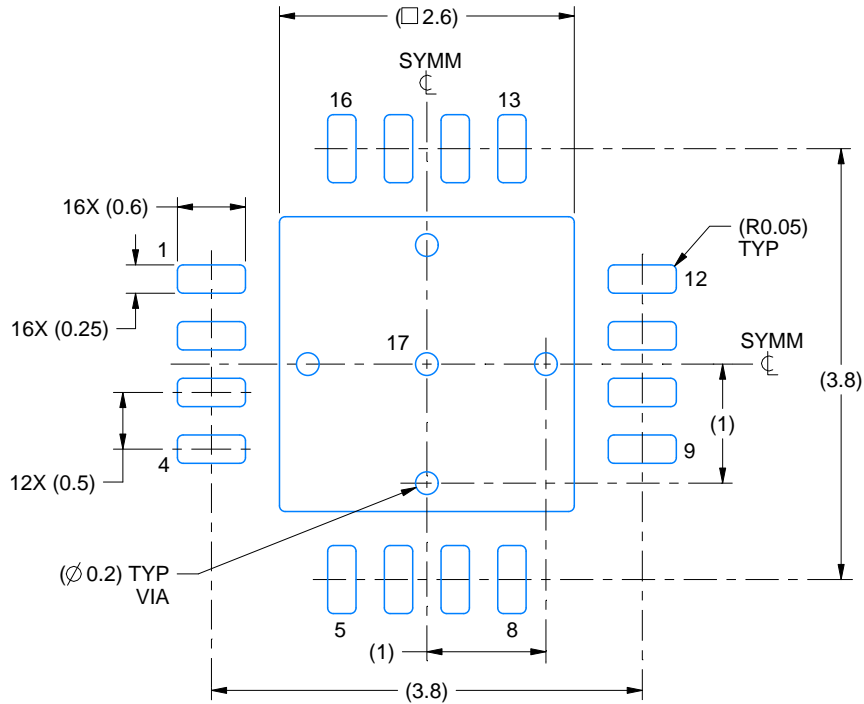

LAND PATTERN EXAMPLE  
EXPOSED METAL SHOWN  
SCALE:15X

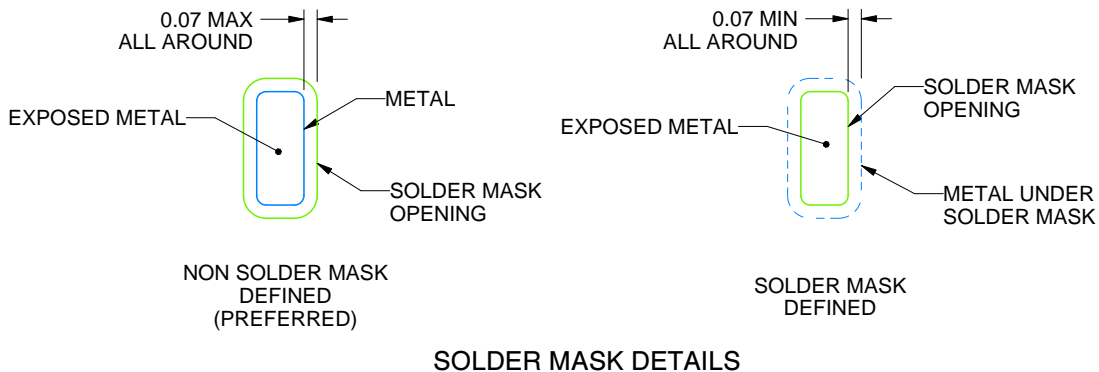

SOLDER MASK DETAILS

4214978/B 01/2017

NOTES: (continued)

- This package is designed to be soldered to a thermal pad on the board. For more information, see Texas Instruments literature number SLUA271 ([www.ti.com/lit/slua271](http://www.ti.com/lit/slua271)).
- Vias are optional depending on application, refer to device data sheet. If any vias are implemented, refer to their locations shown on this view. It is recommended that vias under paste be filled, plugged or tented.

# EXAMPLE STENCIL DESIGN

RGH0016A

WQFN - 0.8 mm max height

PLASTIC QUAD FLATPACK - NO LEAD

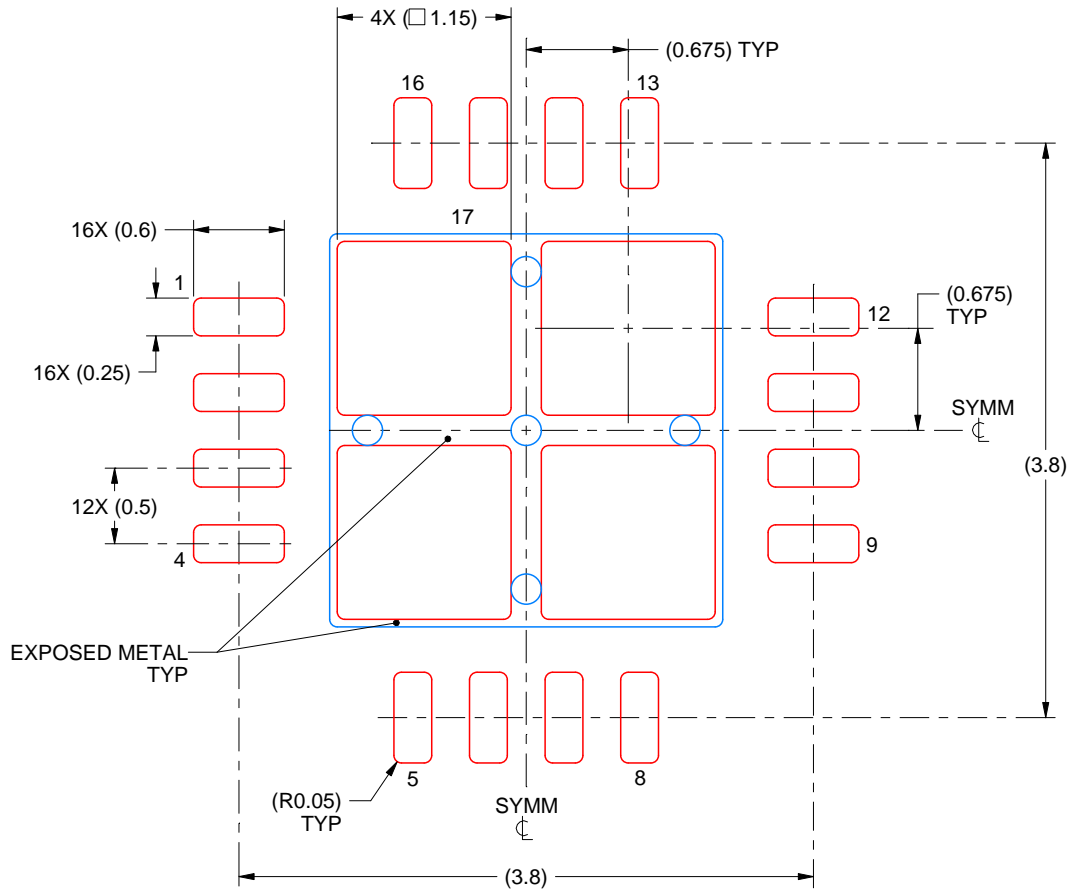

**SOLDER PASTE EXAMPLE**  
BASED ON 0.125 mm THICK STENCIL

EXPOSED PAD 17  
78% PRINTED SOLDER COVERAGE BY AREA UNDER PACKAGE  
SCALE:20X

4214978/B 01/2017

NOTES: (continued)

6. Laser cutting apertures with trapezoidal walls and rounded corners may offer better paste release. IPC-7525 may have alternate design recommendations.

YZR0016

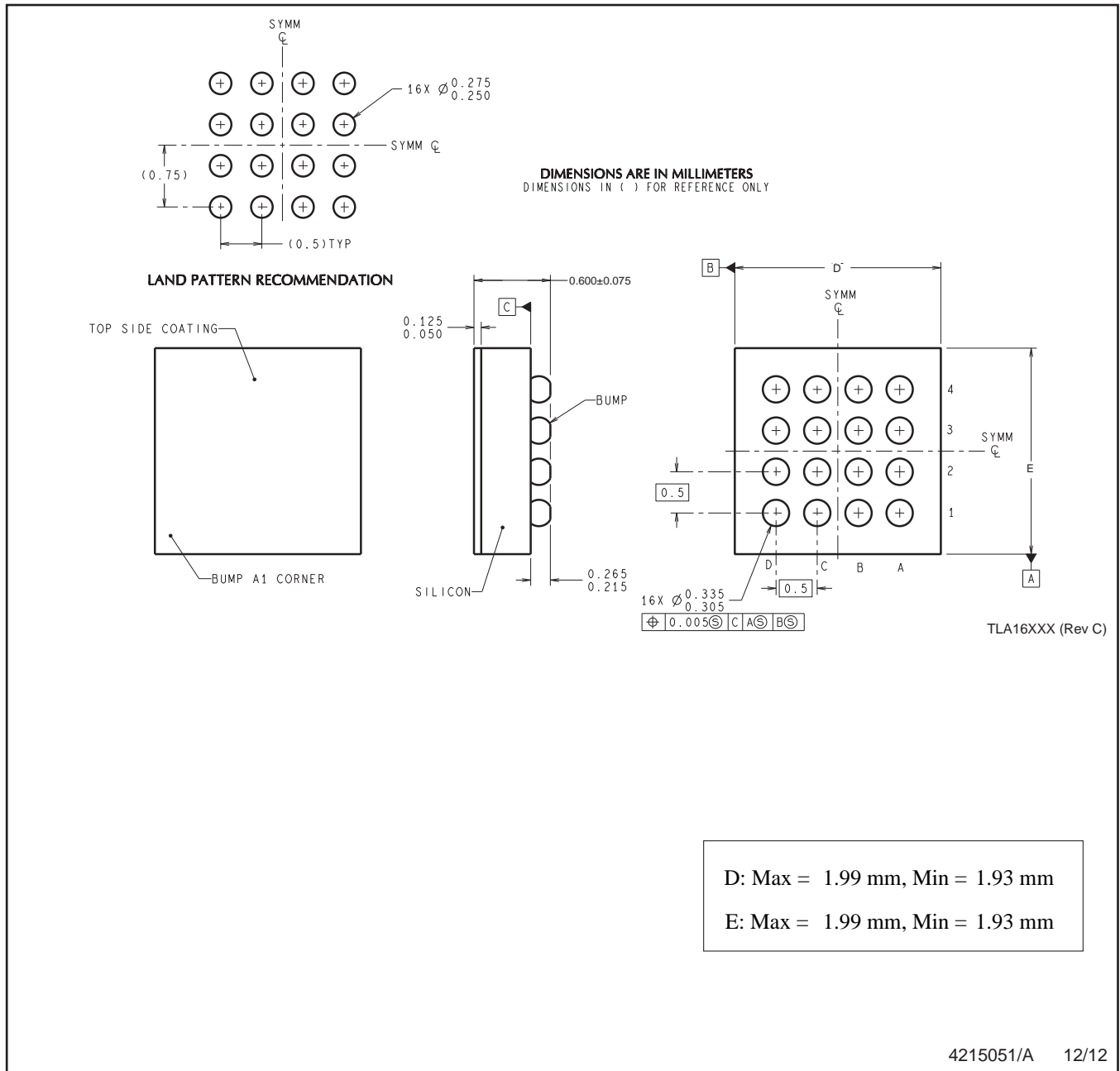

NOTES: A. All linear dimensions are in millimeters. Dimensioning and tolerancing per ASME Y14.5M-1994.  
B. This drawing is subject to change without notice.

## IMPORTANT NOTICE AND DISCLAIMER

TI PROVIDES TECHNICAL AND RELIABILITY DATA (INCLUDING DATA SHEETS), DESIGN RESOURCES (INCLUDING REFERENCE DESIGNS), APPLICATION OR OTHER DESIGN ADVICE, WEB TOOLS, SAFETY INFORMATION, AND OTHER RESOURCES "AS IS" AND WITH ALL FAULTS, AND DISCLAIMS ALL WARRANTIES, EXPRESS AND IMPLIED, INCLUDING WITHOUT LIMITATION ANY IMPLIED WARRANTIES OF MERCHANTABILITY, FITNESS FOR A PARTICULAR PURPOSE OR NON-INFRINGEMENT OF THIRD PARTY INTELLECTUAL PROPERTY RIGHTS.

These resources are intended for skilled developers designing with TI products. You are solely responsible for (1) selecting the appropriate TI products for your application, (2) designing, validating and testing your application, and (3) ensuring your application meets applicable standards, and any other safety, security, regulatory or other requirements.

These resources are subject to change without notice. TI grants you permission to use these resources only for development of an application that uses the TI products described in the resource. Other reproduction and display of these resources is prohibited. No license is granted to any other TI intellectual property right or to any third party intellectual property right. TI disclaims responsibility for, and you will fully indemnify TI and its representatives against, any claims, damages, costs, losses, and liabilities arising out of your use of these resources.

TI's products are provided subject to [TI's Terms of Sale](#) or other applicable terms available either on [ti.com](http://ti.com) or provided in conjunction with such TI products. TI's provision of these resources does not expand or otherwise alter TI's applicable warranties or warranty disclaimers for TI products.

TI objects to and rejects any additional or different terms you may have proposed.

Mailing Address: Texas Instruments, Post Office Box 655303, Dallas, Texas 75265  
Copyright © 2021, Texas Instruments Incorporated