

# **AN-2102 LM3464 and LM5021 DHC 25W Reference Designs**

---

## **ABSTRACT**

This evaluation board consists of a Texas Instruments LM5021-based 120Vac 24W AC/DC flyback converter and a LM3464-based dynamic head room control (DHC) four channel LED driver IC. This demonstration platform was developed so that the customers could evaluate the LM3464 with an AC/DC supply.

## **Contents**

1	Introduction .....	2
2	Key Features .....	2
3	Performance Specifications .....	2
4	LM3464 120VAC, 24W Isolated 4 LED Driver Demo Board Schematic .....	4
5	Bill of Materials (BOM) .....	5
6	Typical Performance Characteristics .....	7
7	PCB Layout .....	9
8	Design Information .....	10
	8.1 1 <sup>ST</sup> Stage - DCM Flyback .....	10
	8.2 2 <sup>ND</sup> Stage - Dynamic Headroom Control .....	10
	8.3 Jumper/Fault Information .....	10
9	Electromagnetic Interference (EMI) .....	10
10	Thermal Analysis .....	11
11	References .....	12

## **List of Figures**

1	Demo Board .....	3
2	Efficiency vs. Line Voltage.....	7
3	Power Factor vs. Line Voltage .....	7
4	Total LED Current vs. LED Temperature .....	7
5	Output Voltage & LED Forward Voltage vs. LED Temperature.....	7
6	Ch1: Line Voltage (100 V/div); Ch3: Line Current (200 mA/div); Time (10 ms/div) .....	7
7	Ch1: Output Voltage (10 V/div); Ch3: Total LED Current (500 mA/div); Time (10 ms/div).....	7
8	Ch1: Drain Voltage (100V/div) Time (4 $\mu$ s/div).....	8
9	Ch1: Output Voltage (10 V/div); Ch3: Total LED Current (500 mV/div); Time (100 ms/div) .....	8
10	Top Layer .....	9
11	Bottom Layer .....	9
12	Peak Conductive EMI scan per CISPR-22, Class B Limits .....	11
13	Top Side Thermal Scan .....	11

## **List of Tables**

1	Bill of Materials (BOM) .....	5
---	-------------------------------	---

## 1 Introduction

Once familiar with the operation of the LM3464 and its control of the AC/DC converter's control loop, the type of AC/DC power supply and the converter's output power becomes less relevant. The evaluation board contains eight CREE XLamp MC-E LEDs. Each XLamp MC-E LED has four separate LEDs in each package for a total of 32 LEDs. The CREE MC-E LED allows for an easy demonstration of the LM3464 four channel operation with eight packaged LEDs. Each LED string is regulated to 200mA. A heat sink is mounted on the back of the PCB to dissipate the heat generated by the LEDs. The LM3464 regulates each LED string current and adjust the secondary output voltage of the AC/DC power supply 0.9V above the LED string forward voltage. The LM3464 monitors the output voltage and adjusts the feedback voltage to the LM5021 primary control. This evaluation also demonstrates the LM3464 thermal fold-back feature which reduces the average LED current when the LED temperature is over 80°C. The AC/DC flyback power supply works in the discontinuous conduction mode and achieves power factor (PF) greater than 0.98.

The schematic, bill of materials, layout and measured performance characteristics are included.

## 2 Key Features

- Drive four strings of LEDs from 120Vac
- Overall Efficiency greater than 82%
- DC/LED Efficiency greater than 90%
- Power Factor greater than 0.98
- Dynamic Headroom Control (DHC)
- Thermal foldback control

## 3 Performance Specifications

Symbol	Parameter	Min	Typ	Max
$V_{IN}$	Input voltage	90 $V_{RMS}$	120 $V_{RMS}$	132 $V_{RMS}$
$V_{OUT}$	LED string voltage	22 V	26 V	30 V
$I_{LED}$	LED string average current per string	-	200 mA	-
$P_{OUT}$	Output power	-	21 W	-
$f_{sw}$	Switching frequency	-	67 kHz	-

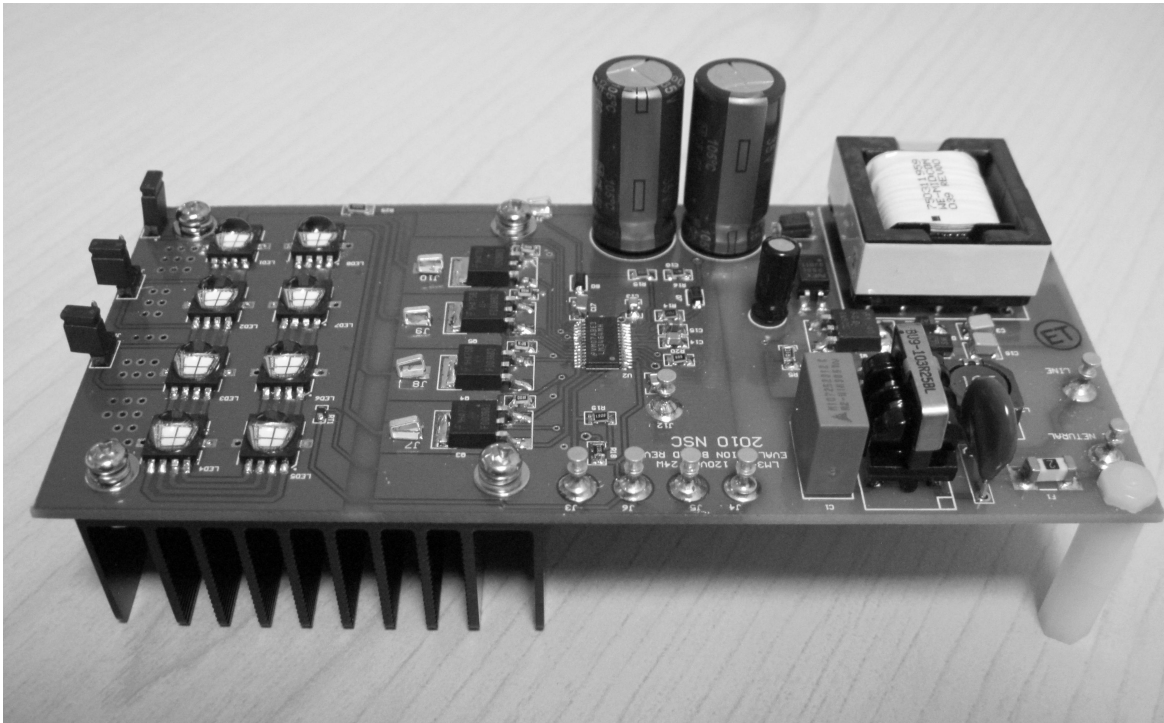

**Figure 1. Demo Board**

4 LM3464 120VAC, 24W Isolated 4 LED Driver Demo Board Schematic

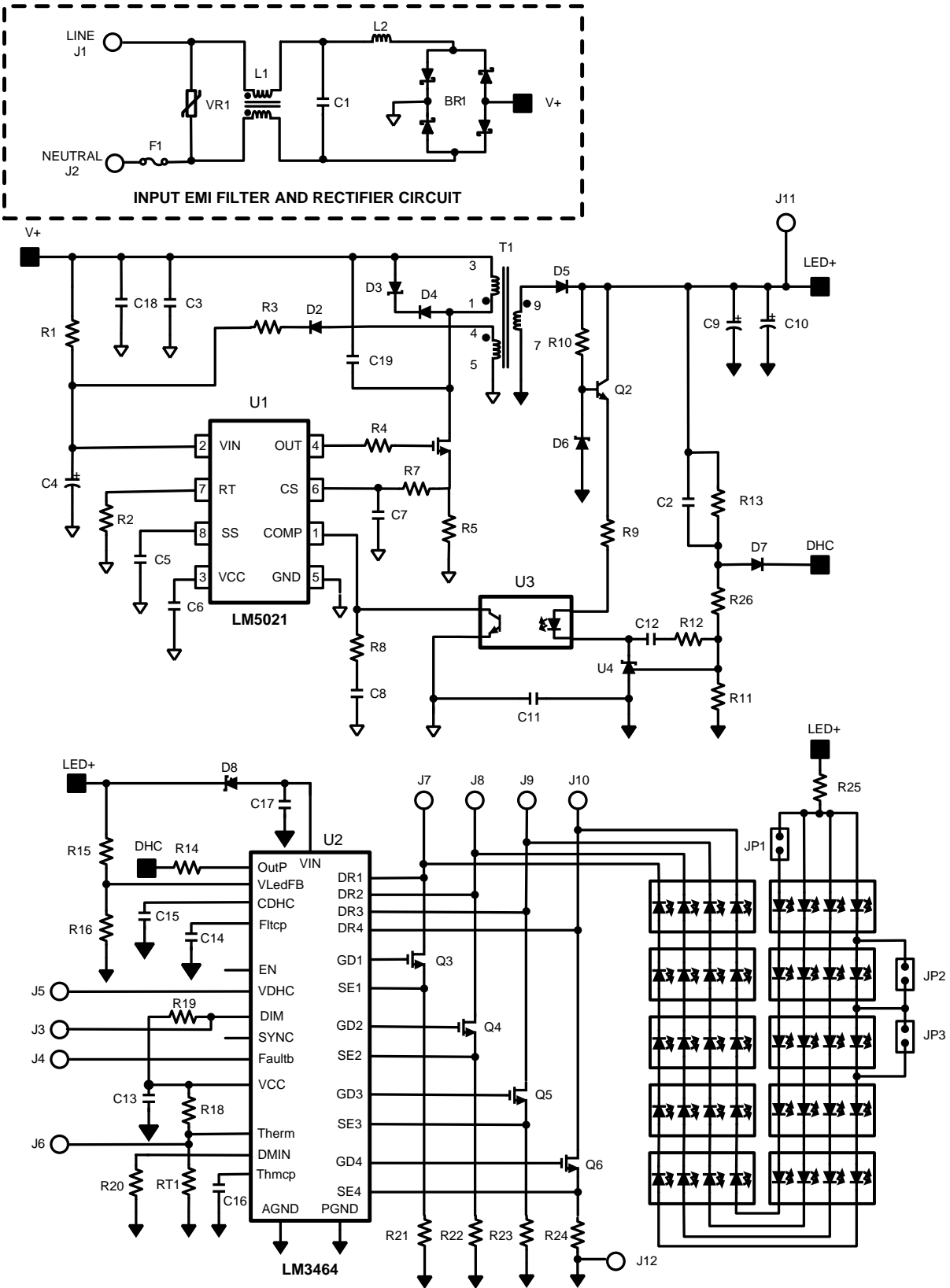



### WARNING

The LM3464 evaluation board has exposed high voltage components that present a shock hazard. Caution must be taken when handling the evaluation board. Avoid touching the evaluation board and removing any cables while the evaluation board is operating.

### WARNING

The ground connection on the evaluation board is NOT referenced to earth ground. If an oscilloscope ground lead is connected to the evaluation board ground test point for analysis and the mains AC power is applied (without any isolation), the fuse (F1) will fail open. For bench evaluation, either the input AC power source or the bench measurement equipment should be isolated from the earth ground connection. Isolating the evaluation board (using 1:1 isolation line isolation transformer) rather than the oscilloscope is highly recommended.

## 5 Bill of Materials (BOM)

**Table 1. Bill of Materials (BOM)**

Designator	Description	Manufacturer	Part Number
C1	CAP .10UF 305VAC EMI SUPPRESSION	EPCOS	B32921C3104M
C2	CAP, CERM, 0.33uF, 50V, +/-10%, X7R, 0805	MuRata	GRM219R71H334KA88D
C3, C18	CAP, CERM, 0.22uF, 250V, +/-10%, X7R, 1210	MuRata	GRM32DR72E224KW01L
C4	CAP, 33UF, 35V, ELECT, 5mmx11mm	Panasonic	EEUFM1V330
C5, C14, C15	CAP, CERM, 0.22uF, 100V, +/-10%, X7R, 0805	MuRata	GRM21AR72A224KAC5L
C6, C13	CAP, CERM, 1uF, 25V, +/-10%, X5R, 0805	AVX	08053D105KAT2A
C7	CAP, CERM, 47pF, 50V, +/-5%, C0G/NP0, 0805	Yageo America	CC0805JRNPO9BN470
C8, C16	CAP, CERM, 0.068uF, 50V, +/-10%, X7R, 0805	AVX	08055C683KAT2A
C9, C10	CAP, 1000UF, 35V, ELECT, 12.5mmx25mm	Panasonic	EEU-FC1V102
C11	CAP, CERM, 1000pF, 250VAC, +/-10%, X7R, 1808	Syfer Technology	1808JA250102KXBSY2
C12	CAP, CERM, 0.15uF, 50V, +/-10%, X7R, 0805	Murata	GRM21BR71H154KA01L
C17	CAP, CERM, 1uF, 50V, +/-10%, X7R, 1206	TDK	C3216X7R1H105K
C19	CAP, CERM, 220pF, 500V, +/-10%, X7R, 1206	Vishay	VJ1206Y221KXEAT5Z
D1	Diode, Switching-Bridge, 400V, 0.8A, MiniDIP	Diodes Inc.	HD04-T
D2, D7	Diode, Schottky, 100V, 0.2A, SOD-123	ST Microelectronics	BAT41ZFILM
D3	DIODE TVS 150V 600W UNI 5% SMA	Littlefuse	SMAJ150A
D4	DIODE, 1000V, 1A, Mini SMA	Comchip Technology	CGRM4007-G
D5	Diode, Schottky, 100V, 2A, SMB	Diodes Inc.	B2100-13-F
D6	Diode, Zener, 10V, 500mW, SOD-123	ON Semiconductor	MMSZ4697T1G
D8	Diode, Zener, 8.2V, 500mW, SOD-123	Central Semiconductor	CMHZ4694
F1	CMHZ4694	Cooper/Bussman	6125FA1A

**Table 1. Bill of Materials (BOM) (continued)**

Designator	Description	Manufacturer	Part Number
H1	Heat Sink	CUI Inc.	VHS-45
J1, J2, J3, J4, J5, J6, J12	Terminal, Turret, TH, Double	Keystone Electronics	1502-2
J7, J8, J9, J10, J11	Test Point, SMT	Keystone Electronics	5016
JP1, JP2, JP3	Jumper	Samtec	TSW-102-07-G-S
L1	Common Mode Choke, 10mH, 0.3A	Coilcraft	BU09-103R25BL
L2	Inductor, Shielded Drum Core, 1mH, 0.45A,SMD	Coilcraft	MSS1038-105KLB
LED1 - LED8	LED	Cree	MCE4WT-A2-0000-000M02
Q1	MOSFET, N-CH, 500V, 6A, DPAK	Fairchild Semiconductor	FDD6N50TM
Q2	Transistor, NPN, 40V, 0.2A, SOT-23	Fairchild Semiconductor	MMBT3904
Q3, Q4, Q5, Q6	MOSFET, N-CH, 100V, 32A, DPAK	Fairchild Semiconducto	FDD3682
R1	RES, 150k ohm, 1%, 0.25W, 1206	Vishay-Dale	CRCW1206150KFKEA
R2	RES, 100k ohm, 1%, 0.125W, 0805	Vishay-Dale	CRCW0805100KFKEA
R3, R4	RES, 10.0 ohm, 1%, 0.125W, 0805	Vishay-Dale	CRCW080510R0FKEA
R5	RES, 0.1 ohm, 5%, 0.25W, 1206	Panasonic	ERJ-8RSJR10V
R7	RES, 10.5k ohm, 1%, 0.1W, 0603	Vishay/Dale	CRCW060310K5FKEA
R8, R12	RES, 1.00k ohm, 1%, 0.125W, 0805	Vishay/Dale	CRCW08051K00FKEA
R9	RES, 5.11k ohm, 1%, 0.125W, 0805	Vishay/Dale	CRCW08055K11FKEA
R10, R11	RES, 10.0k ohm, 1%, 0.125W, 0805	Vishay-Dale	CRCW080510K0FKEA
R13	RES, 105k ohm, 1%, 0.1W, 0603	Vishay-Dale	CRCW0603105KFKEA
R14, R15	RES, 25.5k ohm, 1%, 0.125W, 0805	Vishay-Dale	CRCW080525K5FKEA
R16	RES, 2.67k ohm, 1%, 0.125W, 0805	Vishay-Dale	CRCW08052K67FKEA
R18	RES, 3.01k ohm, 1%, 0.125W, 0805	Vishay-Dale	CRCW08053K01FKEA
R19	RES, 8.06k ohm, 1%, 0.125W, 0805	Vishay-Dale	CRCW08058K06FKEA
R20	RES, 0 ohm, 5%, 0.125W, 0805	Vishay-Dale	CRCW08050000Z0EA
R21, R22, R23, R24	RES, 1.0 ohm, 1%, 0.125W, 0805	Vishay-Dale	CRCW08051R00FKEA
R25	RES, 0 ohm, 5%, 0.25W, 1206	Vishay-Dale	CRCW12060000Z0EA
R26	RES, 22.1k ohm, 1%, 0.125W, 0805	Vishay-Dale	CRCW080522K1FKEA
RT1	Thermistor NTC, 10k ohm, 2%, 0603	Panasonic	ERT-J1VG103GA
T1	Transformer, Flyback, 540UH	Würth Elektornik	750311959
U1	AC-DC Current Mode PWM Controller	Texas Instruments	LM5021-1
U2	Dynamic Headroom Controller w/Therm Control	Texas Instruments	LM3464
U3	Opto Coupler	NEC	PS2501L-1-Q-A
U4	Low-Voltage Adjustable Precision Shunt Regulator	Texas Instruments	LMV431
VR1	Varistor, 150V, 25J, 10mm	Littlefuse	V150LA5P

## 6 Typical Performance Characteristics

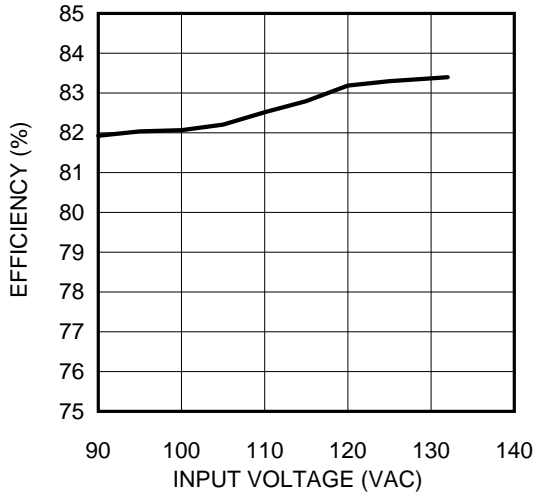

Figure 2. Efficiency vs. Line Voltage

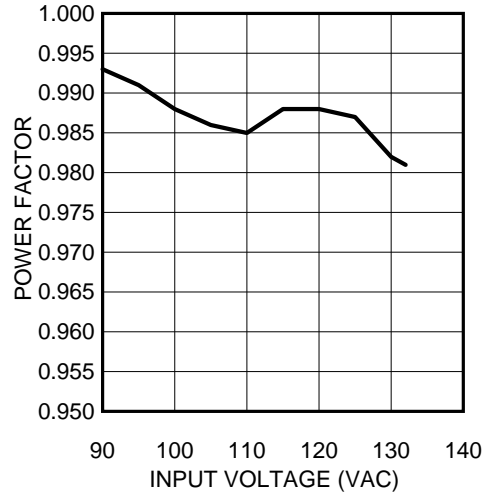

Figure 3. Power Factor vs. Line Voltage

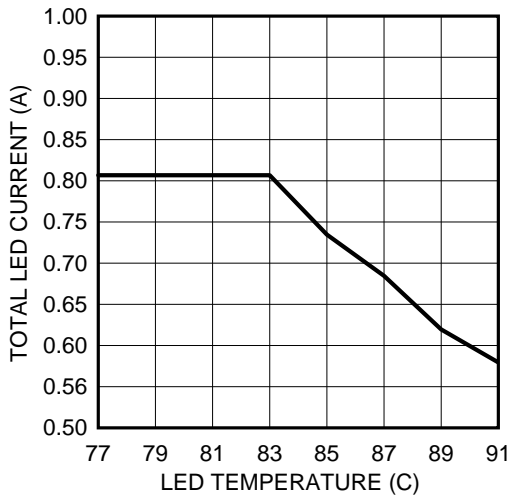

Figure 4. Total LED Current vs. LED Temperature

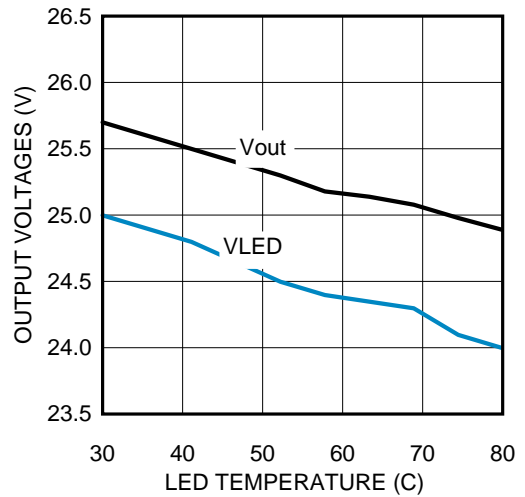
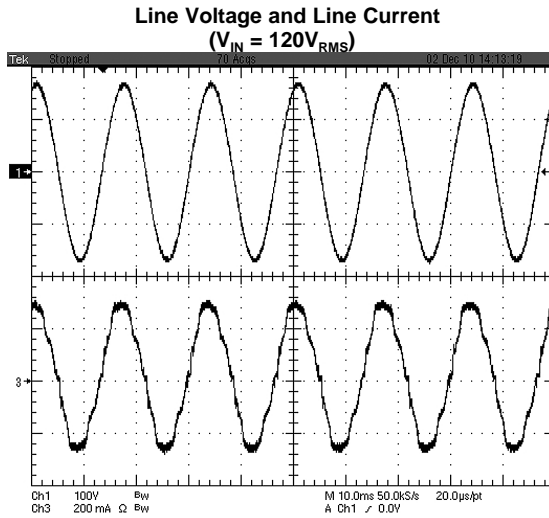
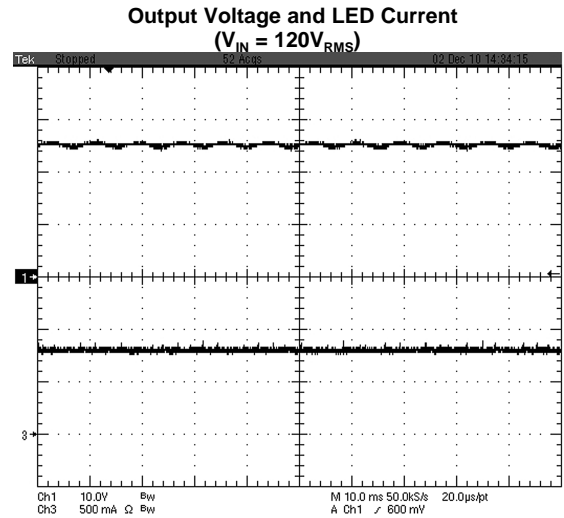

Figure 5. Output Voltage & LED Forward Voltage vs. LED Temperature



**Figure 6. Ch1: Line Voltage (100 V/div);  
Ch3: Line Current (200 mA/div);  
Time (10 ms/div)**



**Figure 7. Ch1: Output Voltage (10 V/div);  
Ch3: Total LED Current (500 mA/div);  
Time (10 ms/div)**

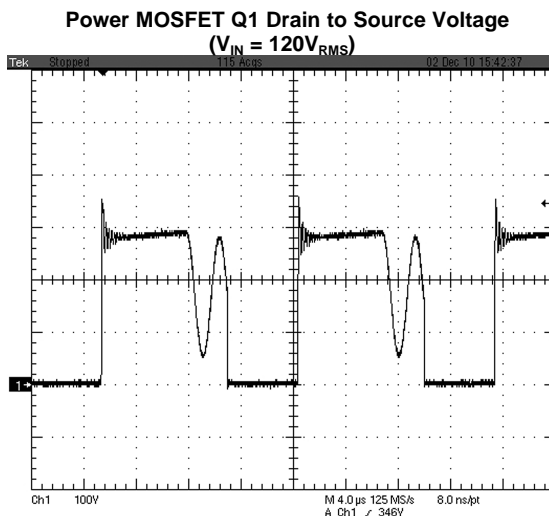

**Figure 8. Ch1: Drain Voltage (100V/div)  
Time (4 μs/div)**

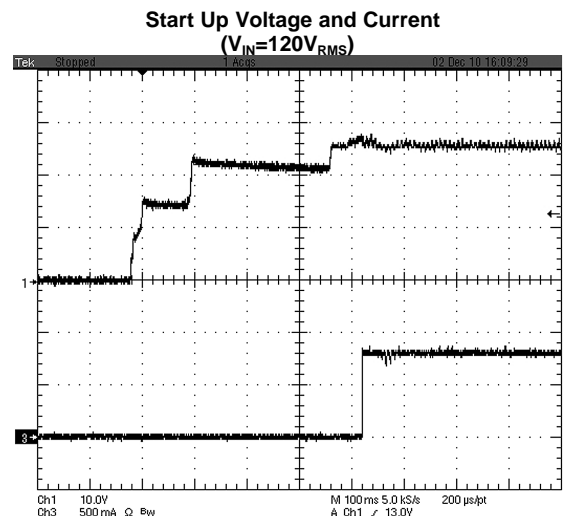

**Figure 9. Ch1: Output Voltage (10 V/div);  
Ch3: Total LED Current (500 mV/div);  
Time (100 ms/div)**

7 PCB Layout

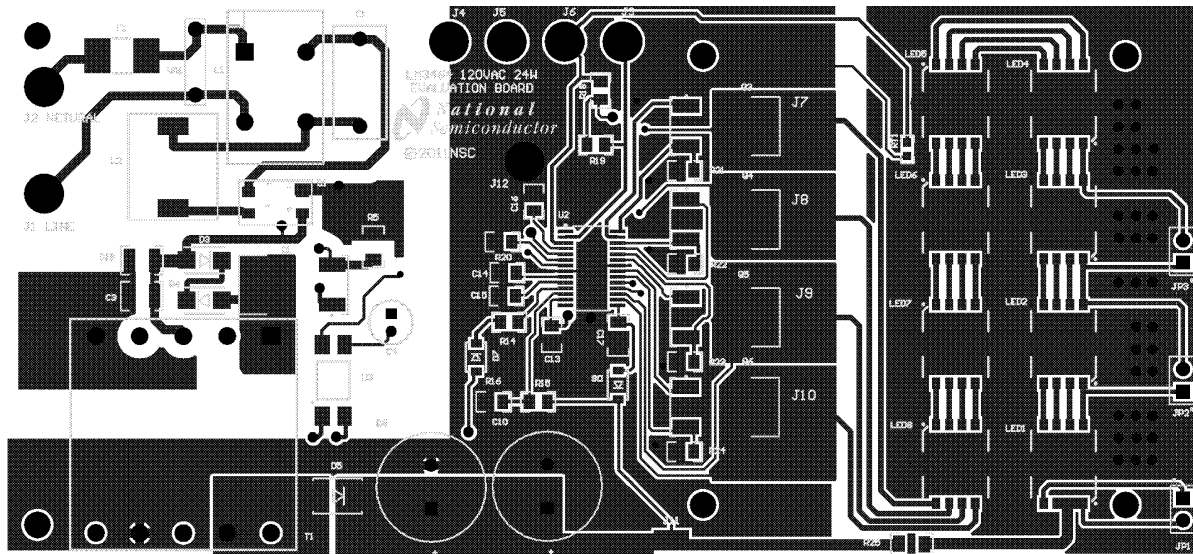

Figure 10. Top Layer

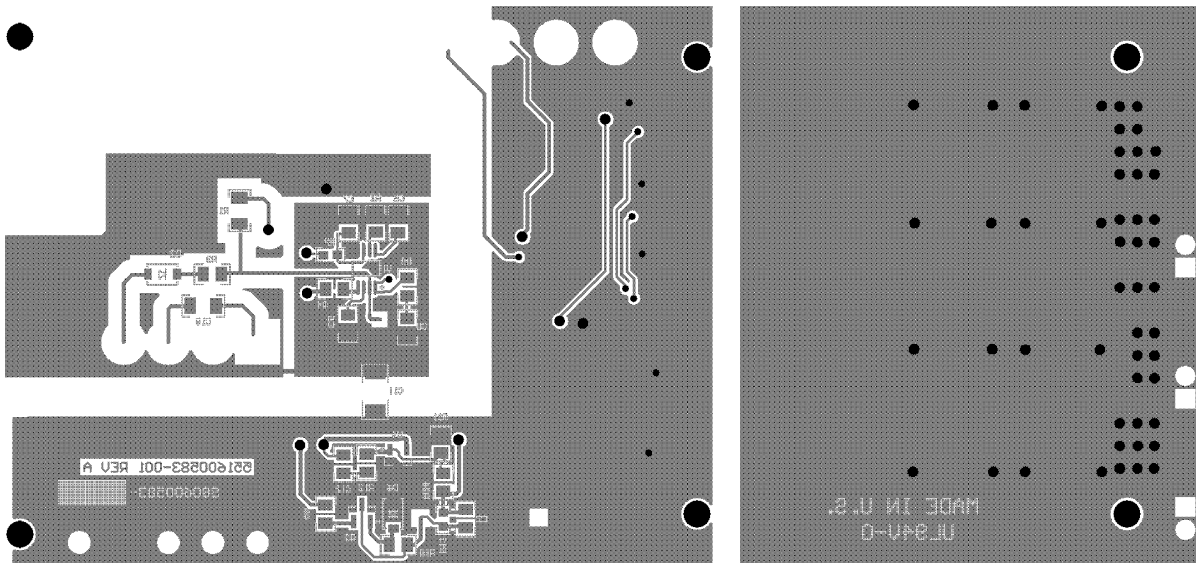

Figure 11. Bottom Layer

## 8 Design Information

### 8.1 1<sup>ST</sup> Stage - DCM Flyback

The evaluation board is considered a two stage LED driver system. The first stage is the AC/DC flyback converter and the second stage is the LM3464 LED current regulator. The first stage employs a NSC LM5021-1 in a discontinuous mode flyback and operates at fixed switching frequency and constant duty cycle. The input current follows the rectified AC input voltage and achieves power factor of 0.98 and higher. To ensure LM5021-1 operates at constant duty cycle, R7 and R1 need to be properly sized so that the slope compensation ramp is bigger than the current sense voltage. In this design, R7 is chosen to be 10.5Kohm and R1 is chosen to be 0.1 ohm. At 40% duty cycle, the peak ramp voltage is 246mV and the peak current sense voltage is around 150mV.

The transformer is designed to keep the flyback converter operating in discontinuous mode at peak output power. For a single stage PFC flyback converter, the peak output power occurs at peak input voltage and is twice the average output power. The transformer used in the evaluation board can handle up to 48W peak output power without saturation.

The feedback loop of the flyback converter includes U4 the LMV431 shunt regulator and U3 the opto coupler. When LM3464 is not controlling the output voltage (during initial power up), the flyback converter output voltage is set by resistor divider R13, R26 and R11 (approximately 17V). Once the LM3464 begins to control the LM5021 and therefore the output voltage by sink/source current through OutP pin and pushes the output voltage up to as high as 33V. In order to have good power factor, the control loop bandwidth has to be lower than 120Hz. For further explanation of LM3464 operation, see the *LM3464, LM3464A LED Driver With Dynamic Headroom Control and Thermal Control Interfaces Data Sheet (SNVS652)*.

### 8.2 2<sup>ND</sup> Stage - Dynamic Headroom Control

The second stage of the evaluation board features the LM3464 which is a linear LED driver controller. The LM3464 is a four string controller, and in this particular demonstration board the LM3464 controls four strings of eight LEDs at 200mA. The internal amplifiers of LM3464 compare the voltages of the current sense resistors to a 200mV reference voltage and control the gate voltages of four external MOSFETs ( Q3 - Q6 ) to achieve linear current regulations.

The voltage headroom which is the voltage difference between the secondary output voltage of the AC/DC power supply and the LED string forward voltage is minimized by the LM3464 controller. By minimizing this voltage, the efficiency of the system is maximized. The LM3464 regulates the drain voltage of the external MOSFET to the voltage of the VDHC pin which is equal to 0.9V, therefore the headroom is about 0.9V.

LM3464 has thermal fold-back function to prevent the LEDs from overheating. When the voltage at the thermal pin ( pin #3 ) is less than 3.25V, the average LED current is reduced by PWM dimming. For this evaluation board, the thermal foldback function starts to kick in when the resistance of the NTC thermistor RT1 reaches 3.2kohm.

### 8.3 Jumper/Fault Information

Jumpers JP1, JP2 and JP3 are provided for the customers to short or disconnect LED strings. One string of LED can be disconnected to the power supply by open connector JP1. One LED each on LED string number one can be shorted by short connectors JP2 or JP3.

LM3464 will continue to regulate the currents of the remaining strings of LEDs when one or more strings of LEDs are shorted or disconnected. It will also continue to regulate the LED current when one or more LEDs in that string are shorted.

## 9 Electromagnetic Interference (EMI)

In order to get a quick estimate of the EMI filter performance, only the PEAK conductive EMI scan was measured and the data was compared to the Class B conducted EMI limits published in FCC – 47, section 15.



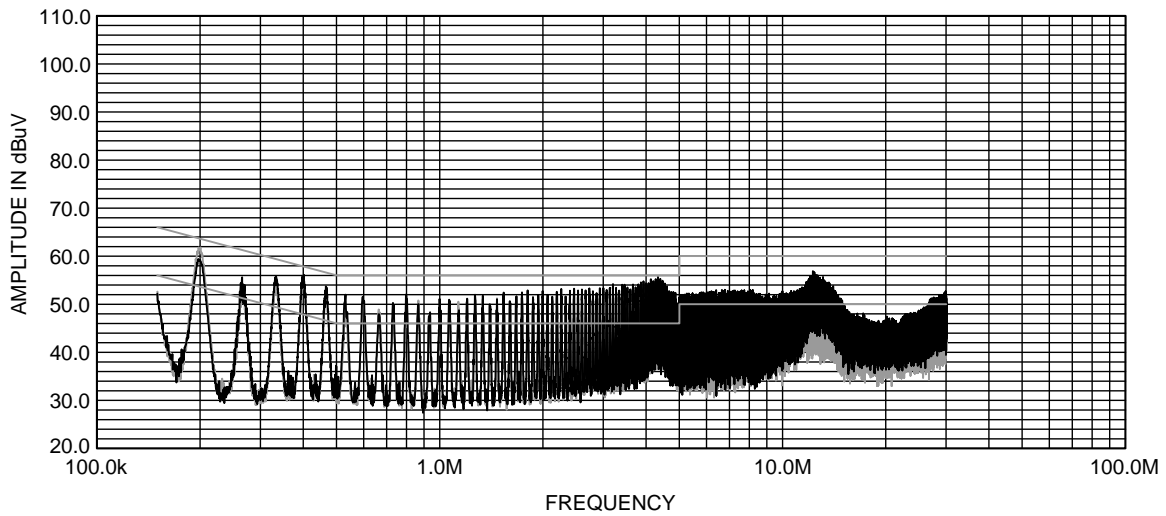

Figure 12. Peak Conductive EMI scan per CISPR-22, Class B Limits

## 10 Thermal Analysis

The board temperature was measured using an IR camera (HIS-3000, Wahl) while running under the following conditions:

$$V_{IN} = 120 V_{RMS}$$

The results are shown in [Figure 13](#).

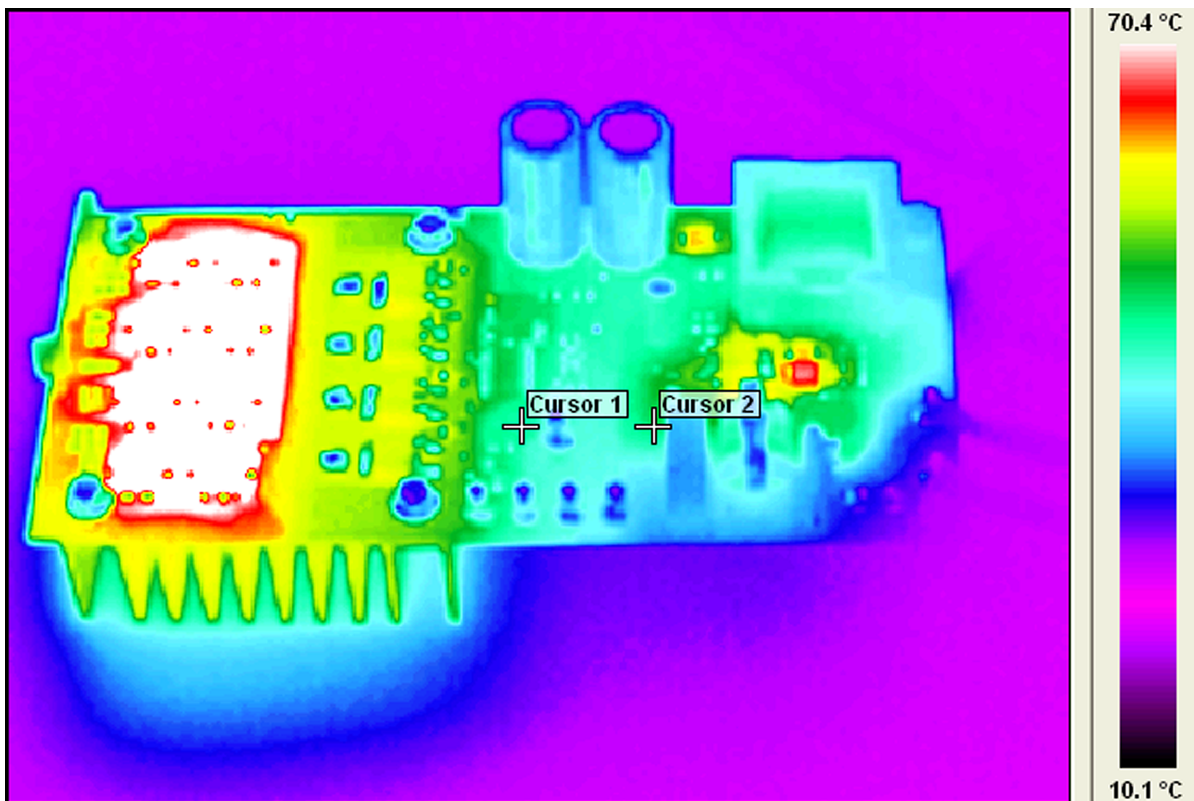

Figure 13. Top Side Thermal Scan

## 11 References

*LM3464, LM3464A LED Driver With Dynamic Headroom Control and Thermal Control Interfaces Data Sheet* ([SNVS652](#))



## IMPORTANT NOTICE

Texas Instruments Incorporated and its subsidiaries (TI) reserve the right to make corrections, enhancements, improvements and other changes to its semiconductor products and services per JESD46, latest issue, and to discontinue any product or service per JESD48, latest issue. Buyers should obtain the latest relevant information before placing orders and should verify that such information is current and complete. All semiconductor products (also referred to herein as "components") are sold subject to TI's terms and conditions of sale supplied at the time of order acknowledgment.

TI warrants performance of its components to the specifications applicable at the time of sale, in accordance with the warranty in TI's terms and conditions of sale of semiconductor products. Testing and other quality control techniques are used to the extent TI deems necessary to support this warranty. Except where mandated by applicable law, testing of all parameters of each component is not necessarily performed.

TI assumes no liability for applications assistance or the design of Buyers' products. Buyers are responsible for their products and applications using TI components. To minimize the risks associated with Buyers' products and applications, Buyers should provide adequate design and operating safeguards.

TI does not warrant or represent that any license, either express or implied, is granted under any patent right, copyright, mask work right, or other intellectual property right relating to any combination, machine, or process in which TI components or services are used. Information published by TI regarding third-party products or services does not constitute a license to use such products or services or a warranty or endorsement thereof. Use of such information may require a license from a third party under the patents or other intellectual property of the third party, or a license from TI under the patents or other intellectual property of TI.

Reproduction of significant portions of TI information in TI data books or data sheets is permissible only if reproduction is without alteration and is accompanied by all associated warranties, conditions, limitations, and notices. TI is not responsible or liable for such altered documentation. Information of third parties may be subject to additional restrictions.

Resale of TI components or services with statements different from or beyond the parameters stated by TI for that component or service voids all express and any implied warranties for the associated TI component or service and is an unfair and deceptive business practice. TI is not responsible or liable for any such statements.

Buyer acknowledges and agrees that it is solely responsible for compliance with all legal, regulatory and safety-related requirements concerning its products, and any use of TI components in its applications, notwithstanding any applications-related information or support that may be provided by TI. Buyer represents and agrees that it has all the necessary expertise to create and implement safeguards which anticipate dangerous consequences of failures, monitor failures and their consequences, lessen the likelihood of failures that might cause harm and take appropriate remedial actions. Buyer will fully indemnify TI and its representatives against any damages arising out of the use of any TI components in safety-critical applications.

In some cases, TI components may be promoted specifically to facilitate safety-related applications. With such components, TI's goal is to help enable customers to design and create their own end-product solutions that meet applicable functional safety standards and requirements. Nonetheless, such components are subject to these terms.

No TI components are authorized for use in FDA Class III (or similar life-critical medical equipment) unless authorized officers of the parties have executed a special agreement specifically governing such use.

Only those TI components which TI has specifically designated as military grade or "enhanced plastic" are designed and intended for use in military/aerospace applications or environments. Buyer acknowledges and agrees that any military or aerospace use of TI components which have **not** been so designated is solely at the Buyer's risk, and that Buyer is solely responsible for compliance with all legal and regulatory requirements in connection with such use.

TI has specifically designated certain components as meeting ISO/TS16949 requirements, mainly for automotive use. In any case of use of non-designated products, TI will not be responsible for any failure to meet ISO/TS16949.

### Products

Audio	<a href="http://www.ti.com/audio">www.ti.com/audio</a>
Amplifiers	<a href="http://amplifier.ti.com">amplifier.ti.com</a>
Data Converters	<a href="http://dataconverter.ti.com">dataconverter.ti.com</a>
DLP® Products	<a href="http://www.dlp.com">www.dlp.com</a>
DSP	<a href="http://dsp.ti.com">dsp.ti.com</a>
Clocks and Timers	<a href="http://www.ti.com/clocks">www.ti.com/clocks</a>
Interface	<a href="http://interface.ti.com">interface.ti.com</a>
Logic	<a href="http://logic.ti.com">logic.ti.com</a>
Power Mgmt	<a href="http://power.ti.com">power.ti.com</a>
Microcontrollers	<a href="http://microcontroller.ti.com">microcontroller.ti.com</a>
RFID	<a href="http://www.ti-rfid.com">www.ti-rfid.com</a>
OMAP Applications Processors	<a href="http://www.ti.com/omap">www.ti.com/omap</a>
Wireless Connectivity	<a href="http://www.ti.com/wirelessconnectivity">www.ti.com/wirelessconnectivity</a>

### Applications

Automotive and Transportation	<a href="http://www.ti.com/automotive">www.ti.com/automotive</a>
Communications and Telecom	<a href="http://www.ti.com/communications">www.ti.com/communications</a>
Computers and Peripherals	<a href="http://www.ti.com/computers">www.ti.com/computers</a>
Consumer Electronics	<a href="http://www.ti.com/consumer-apps">www.ti.com/consumer-apps</a>
Energy and Lighting	<a href="http://www.ti.com/energy">www.ti.com/energy</a>
Industrial	<a href="http://www.ti.com/industrial">www.ti.com/industrial</a>
Medical	<a href="http://www.ti.com/medical">www.ti.com/medical</a>
Security	<a href="http://www.ti.com/security">www.ti.com/security</a>
Space, Avionics and Defense	<a href="http://www.ti.com/space-avionics-defense">www.ti.com/space-avionics-defense</a>
Video and Imaging	<a href="http://www.ti.com/video">www.ti.com/video</a>

### TI E2E Community

[e2e.ti.com](http://e2e.ti.com)