

How SYNC Logic Affects EMI Performance for Dual-Channel Buck Converters

Gavin Wang, Daniel Li, Vincent Zhang, Andy Chen

ABSTRACT

The LMR140X0 series of buck regulators from TI are monolithic, integrated circuits with an internal MOSFET switch. The LMR140X0 device is widely used in automotive and industrial applications. In these applications, a multichannel buck converter is needed. The LMR140X0 has a frequency synchronization function. This application report discusses how SYNC logic affects EMI performance of a dual-channel buck converter.

First, this report describes the FFT analysis for two buck converters working in different modes. Next, the bench test is provided to verify the theories. Last, a conducted EMI performance comparison between the same-phase mode, phase-shift mode, and free-run mode, are presented.

Contents

1	Introduction	2
2	FFT Simulation for Two Independent Buck Converters	2
3	Bench Verification	4
4	Conducted EMI Comparison Between Same-Phase Mode and Phase-Shift Mode	8
5	Conducted EMI Comparison Between Free-Run Mode and Phase-Shift Mode	11
6	Summary	11
7	References	12

List of Figures

1	SIMPLIS Model of Dual-Channel Buck Converter.....	2
2	FFT Analysis Result in Phase-Shift Mode.....	3
3	FFT Analysis Result in Same-Phase Mode	3
4	LMR14030 Two-Buck Converter Schematic	4
5	Waveforms for Same-Phase Mode.....	5
6	Waveforms for Phase-Shift Mode	6
7	Waveforms for Free-Run Mode.....	7
8	Peak Measurement of Same-Phase Mode and Phase-Shift Mode	8
9	Average Measurement of Same-Phase Mode and Phase-Shift Mode	8
10	Peak Measurement of Differential Mode	9
11	Average Measurement of Differential Mode.....	9
12	Peak Measurement of Common-Mode	10
13	Average Measurement of Common-Mode	10
14	Peak Measurement of Free-Run Mode and Phase-Shift Mode.....	11
15	Average Measurement of Free-Run Mode and Phase-Shift Mode	11

List of Tables

1	Specifications.....	4
---	---------------------	---

Trademarks

All trademarks are the property of their respective owners.

1 Introduction

The LMR140x0 is a 40-V, step-down regulator with an integrated high-side MOSFET. With a wide input range, this device is suitable for various applications, from industrial to automotive. In these applications including multi rails, step-down converters sharing the same input are needed. A multichannel buck converter can avoid the AM frequency range, reduce the solution size, and it is easy to choose an inductor. The LMR140X0 has a frequency synchronization function. This application report discusses how SYNC logic affects EMI performance for dual-channel buck converter.

2 FFT Simulation for Two Independent Buck Converters

Figure 1 shows the SIMPLIS simulation model for a dual-channel buck converter. The input voltage is 12 V and the target voltage for the dual output is 5 V and 3.3 V. By using this model, users can do FFT analysis for the input current in the same-phase mode and phase-shift mode.

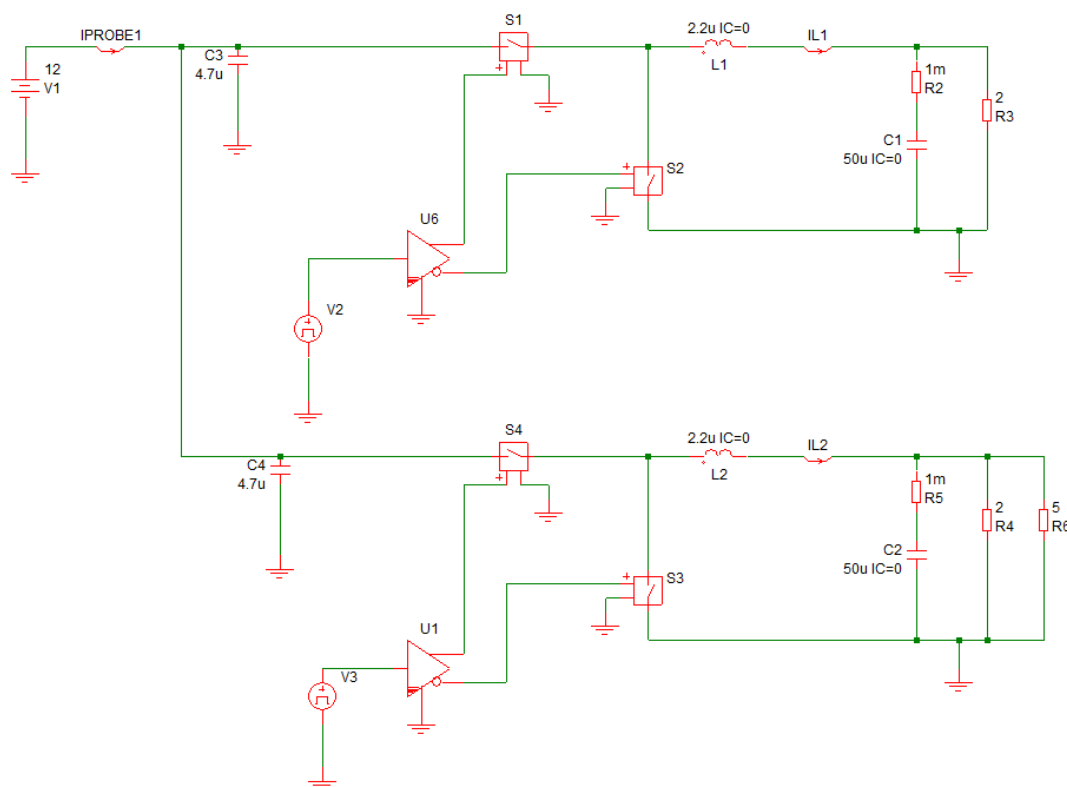

Figure 1. SIMPLIS Model of Dual-Channel Buck Converter

Figure 2 and Figure 3 show the FFT results for the input current in the same-phase mode and phase-shift mode. The phase-shift mode reduces the first harmonic of the switching frequency. The second harmonic becomes dominant after the phase-shift mode.

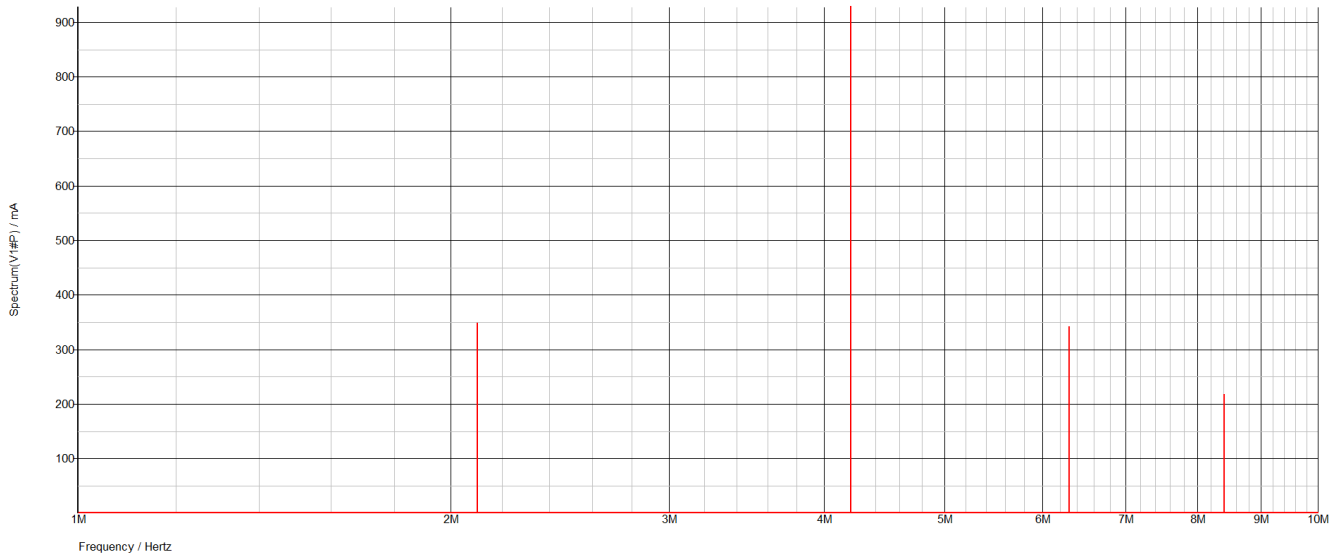

Figure 2. FFT Analysis Result in Phase-Shift Mode

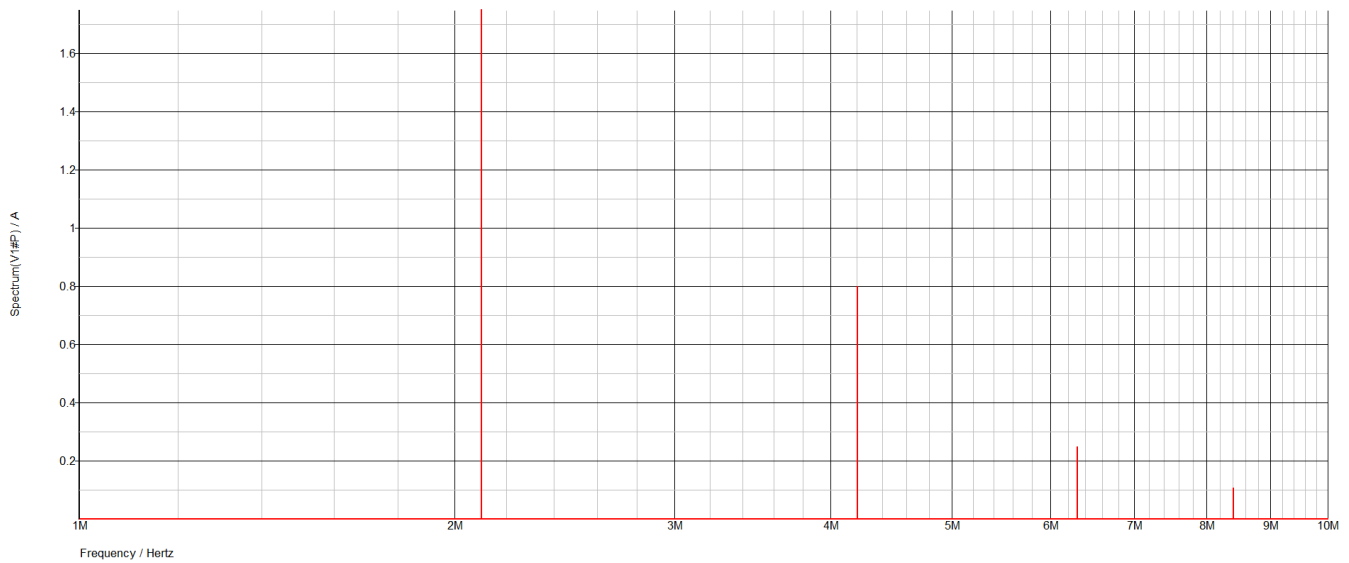

Figure 3. FFT Analysis Result in Same-Phase Mode

3 Bench Verification

This section introduces a use case about how to realize two buck converter work using the SYNC logic working in different modes. We take LMR14030 as an example. Input and output parameters are shown in Table 1.

Table 1. Specifications

PARAMETER	SPECIFICATION
V_{in_Min}	12-V DC
V_{out1}	5 V, 2.5-A DC
V_{out2}	3.3 V, 2.31-A DC
Target switching frequency	2.2 MHz

Figure 4 shows the overall schematic of the LMR14030 configured for a dual-channel buck converter that can work in different modes. The SYNC pin is controlled by the LMC555, to generate a different signal to control the SYNC pin in the same-phase mode, phase-shift mode, and free-run working mode.

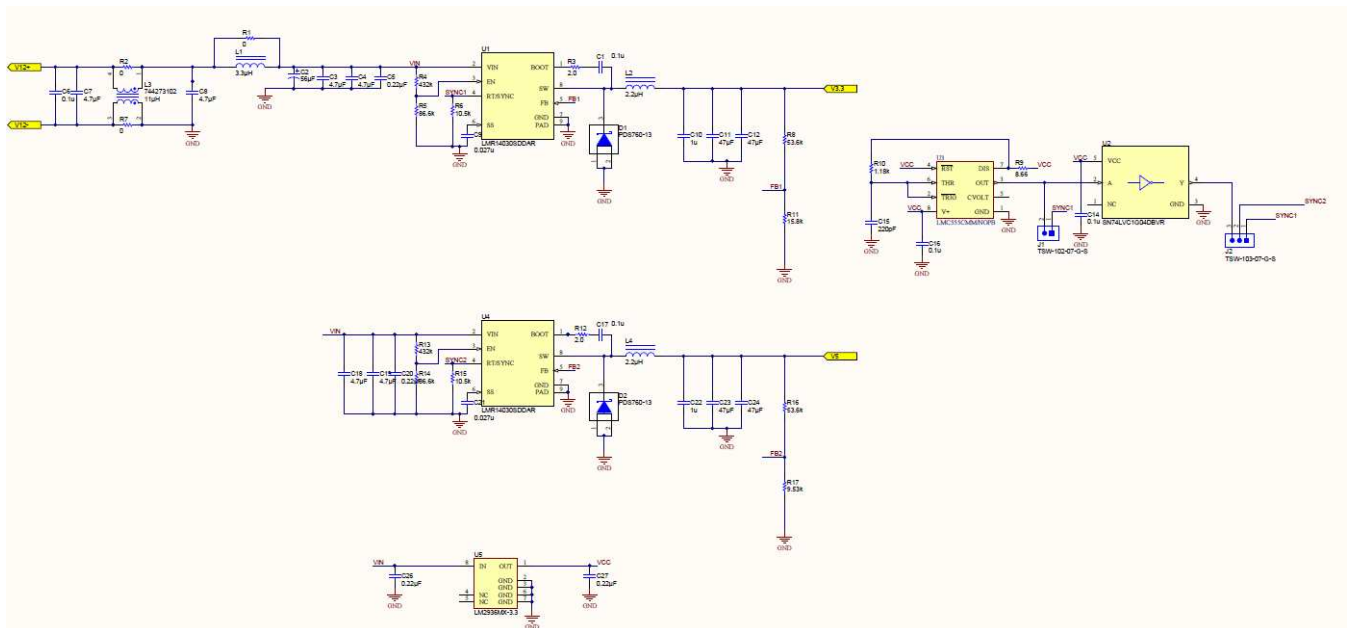

Figure 4. LMR14030 Two-Buck Converter Schematic

Figure 5, Figure 6, and Figure 7 show the two switching-node waveforms in the same-phase mode, phase-shift mode, and free-run working mode.

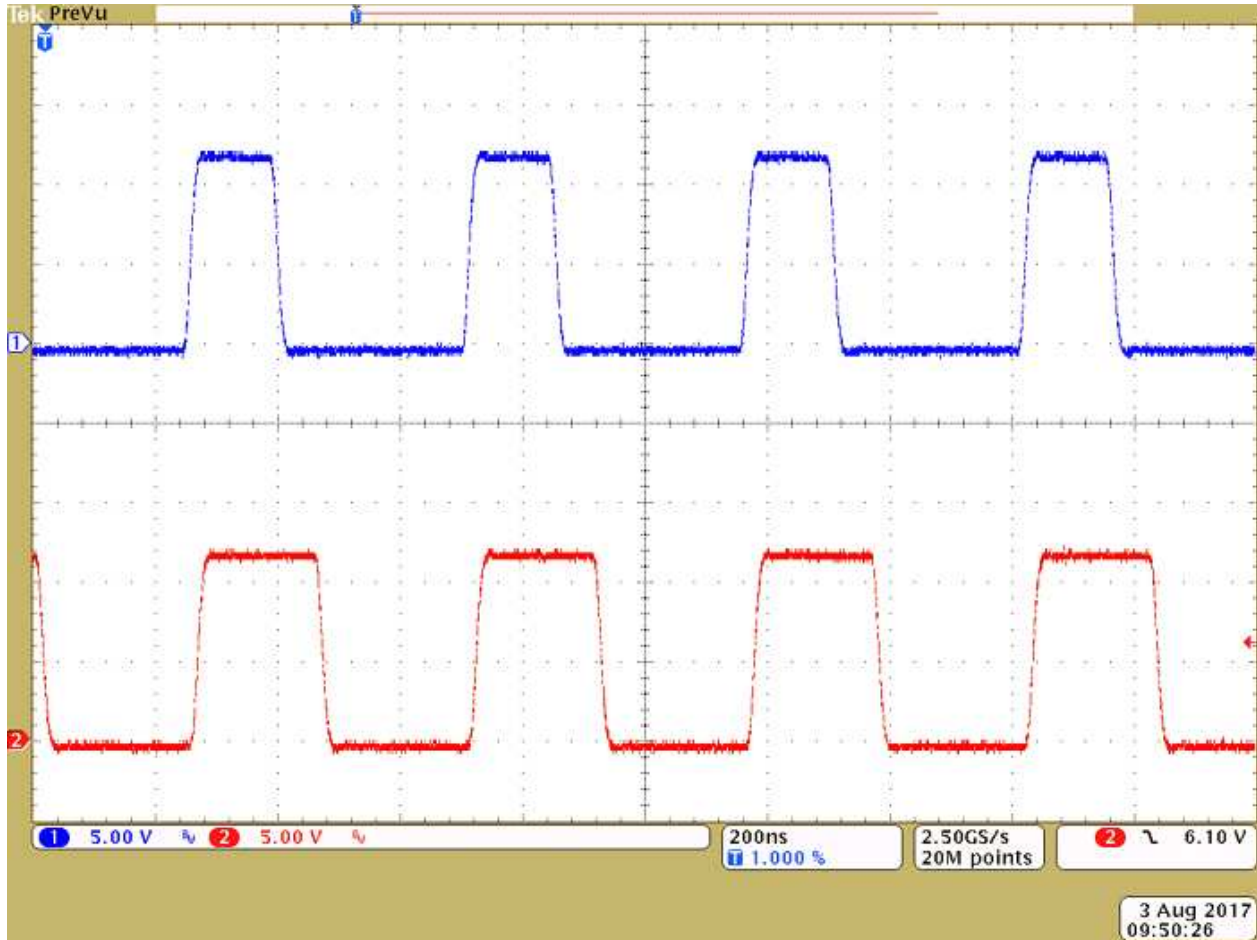

Figure 5. Waveforms for Same-Phase Mode

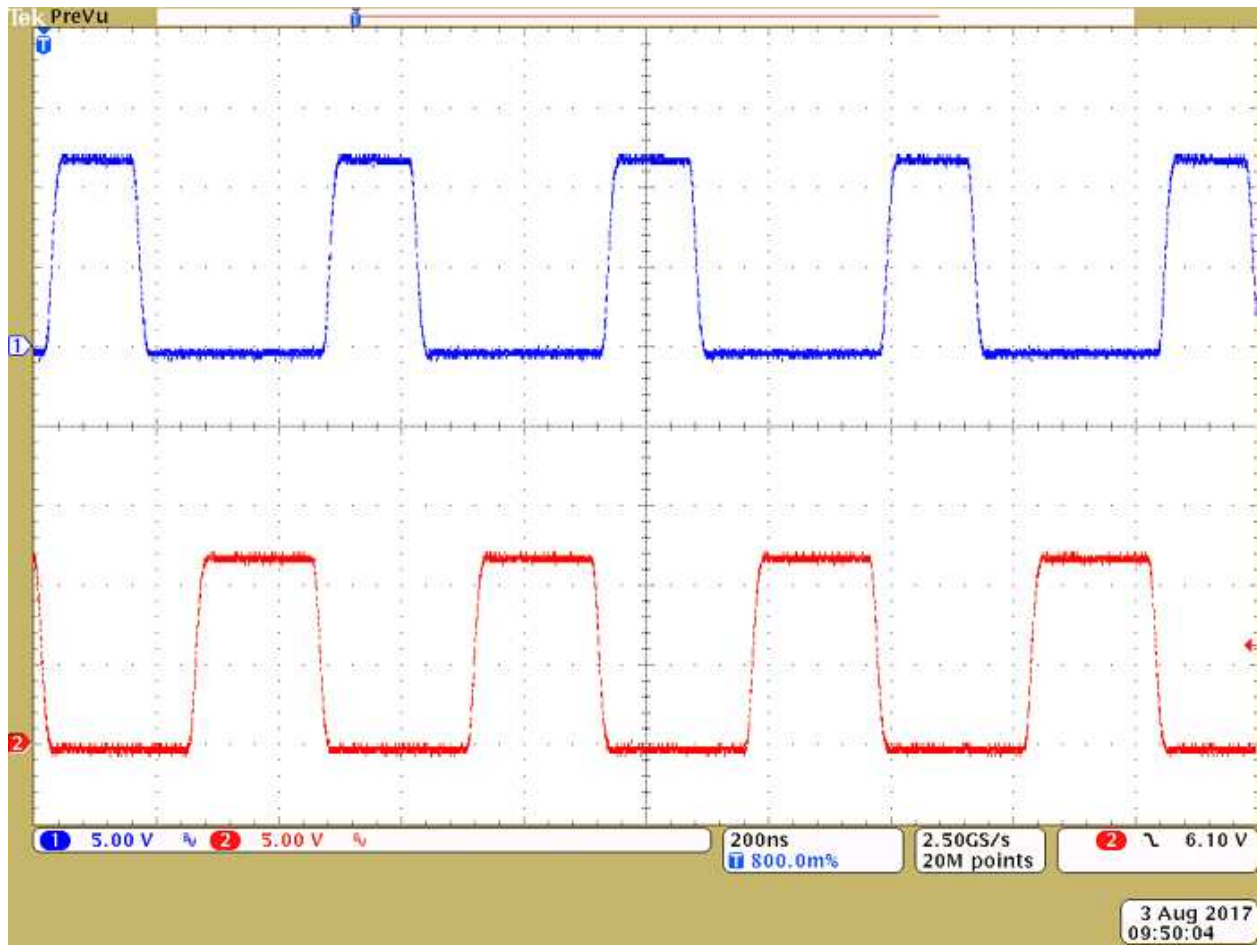

Figure 6. Waveforms for Phase-Shift Mode

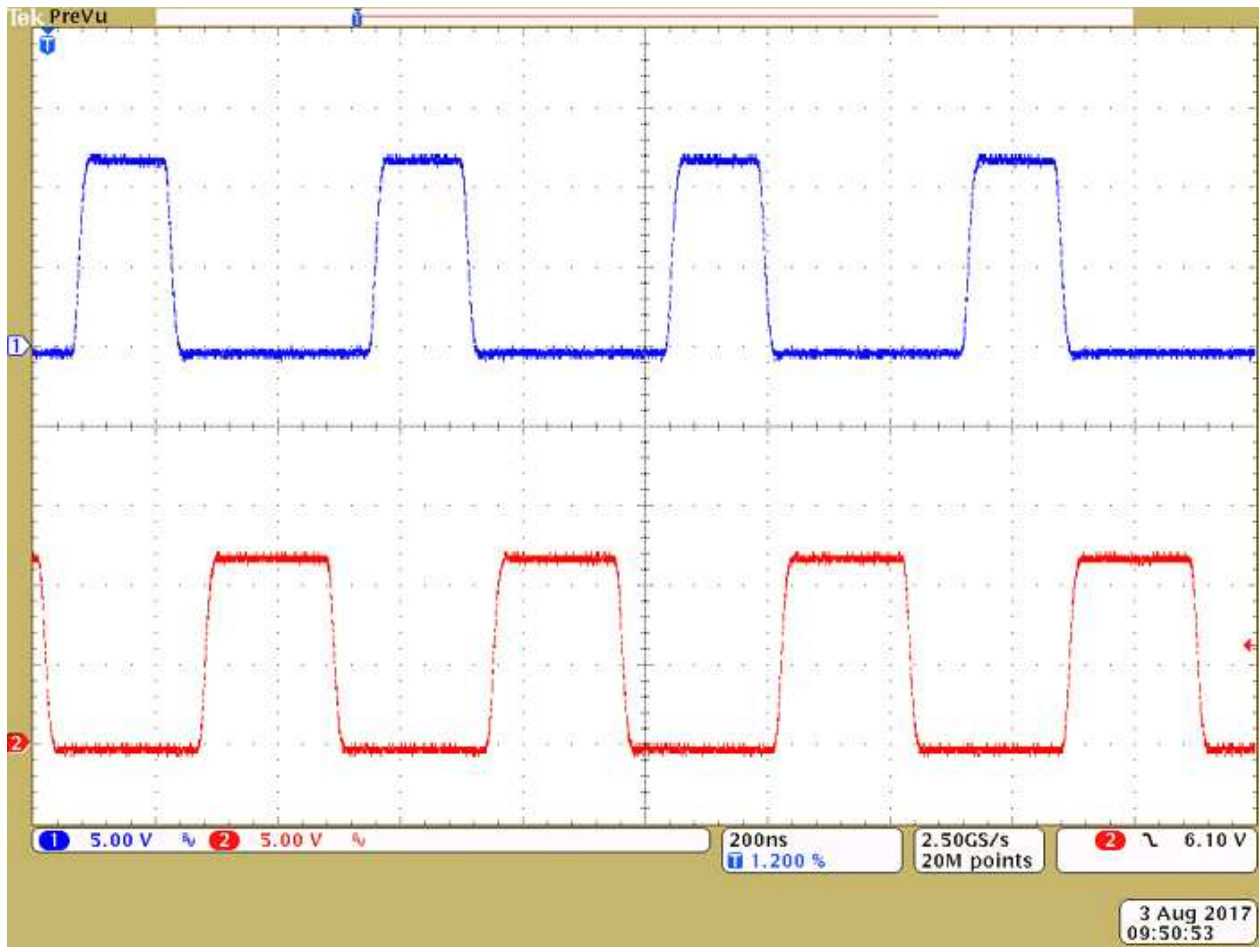

Figure 7. Waveforms for Free-Run Mode

4 Conducted EMI Comparison Between Same-Phase Mode and Phase-Shift Mode

Figure 8 and Figure 9 show the EMI performance in the same-phase mode and phase-shift mode, for the peak and average measurements, respectively. The red line shows the data in same-phase mode and the green line shows that in phase-shift mode. Developers can use the current probe to separate the differential mode and common mode.

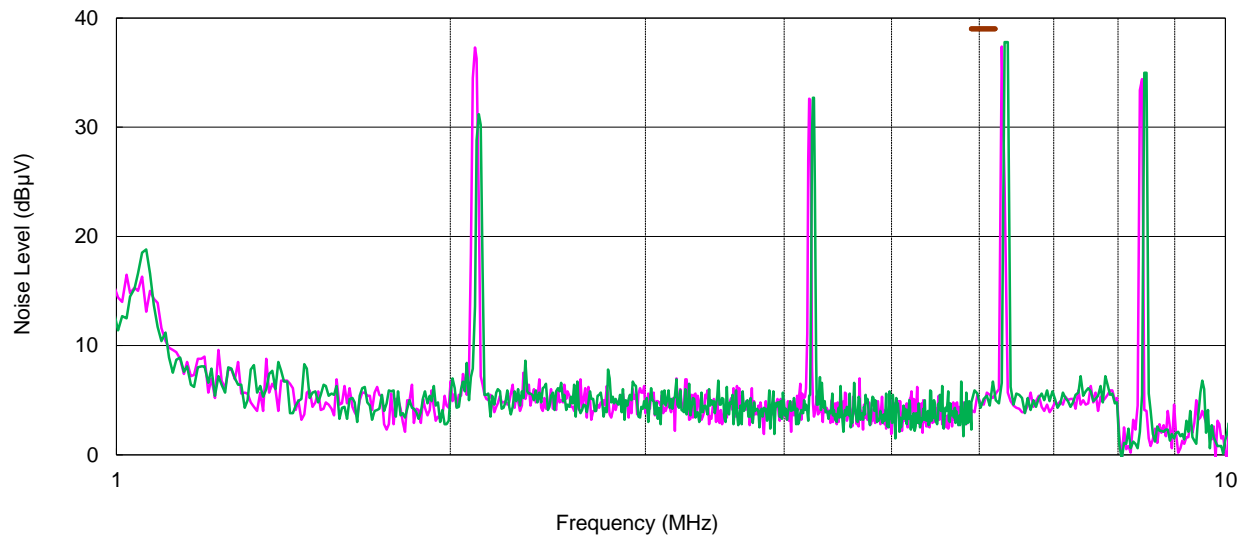

Figure 8. Peak Measurement of Same-Phase Mode and Phase-Shift Mode

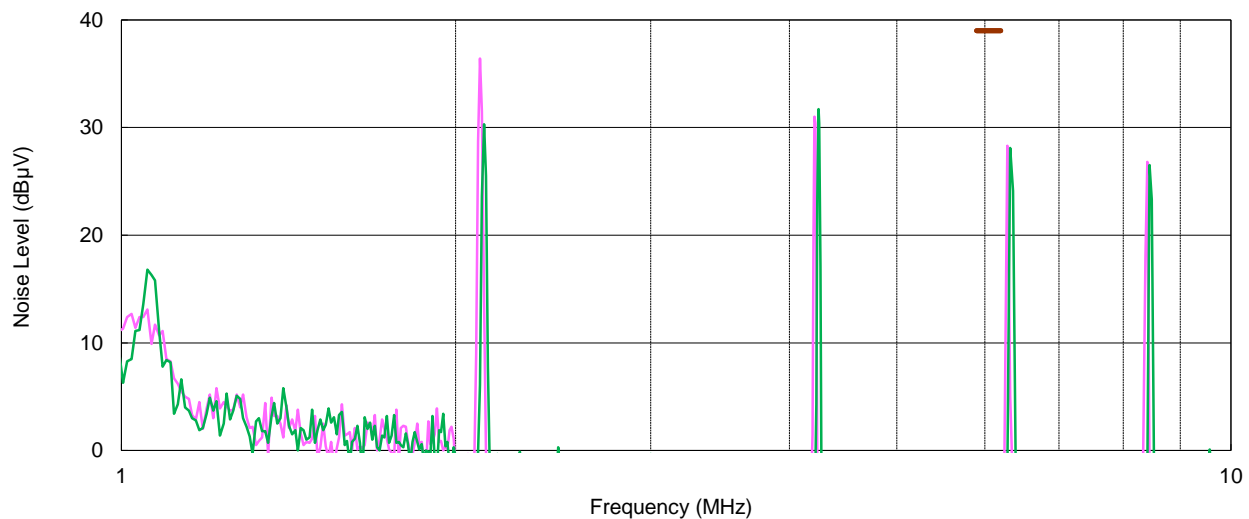

Figure 9. Average Measurement of Same-Phase Mode and Phase-Shift Mode

4.1 Differential Mode: Conducted, EMI Comparison Between Same-Phase Mode and Phase-Shift Mode

The result of the FFT analysis reflects the differential-mode, conducted, EMI performance. [Figure 10](#) and [Figure 11](#) show the EMI performance in differential mode, for the peak and average measurements, respectively. The red line shows the data in the same-phase condition, and the green line shows the data in the phase-shift condition. The phase-shift condition reduces the first harmonic of the switching frequency, as shown. The phase-shift condition also reduces the volume of input of the differential EMI filter. The FFT simulation results are verified.

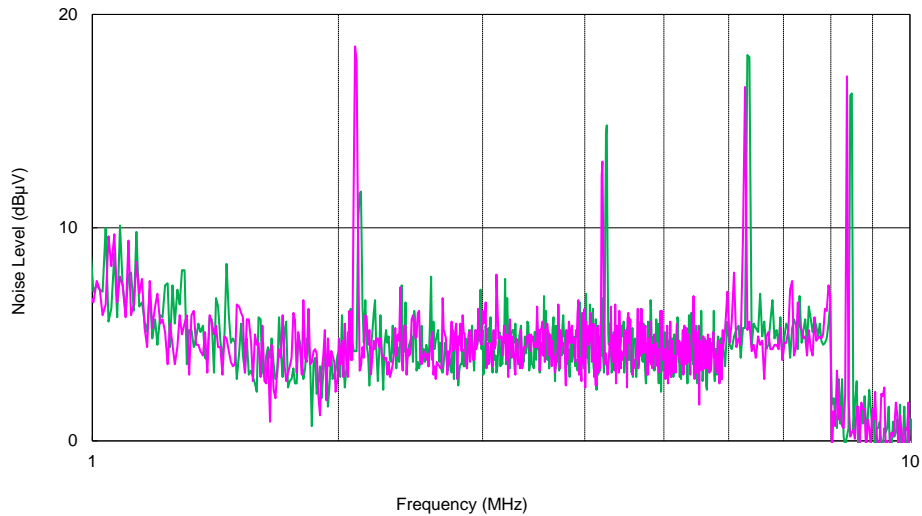

Figure 10. Peak Measurement of Differential Mode

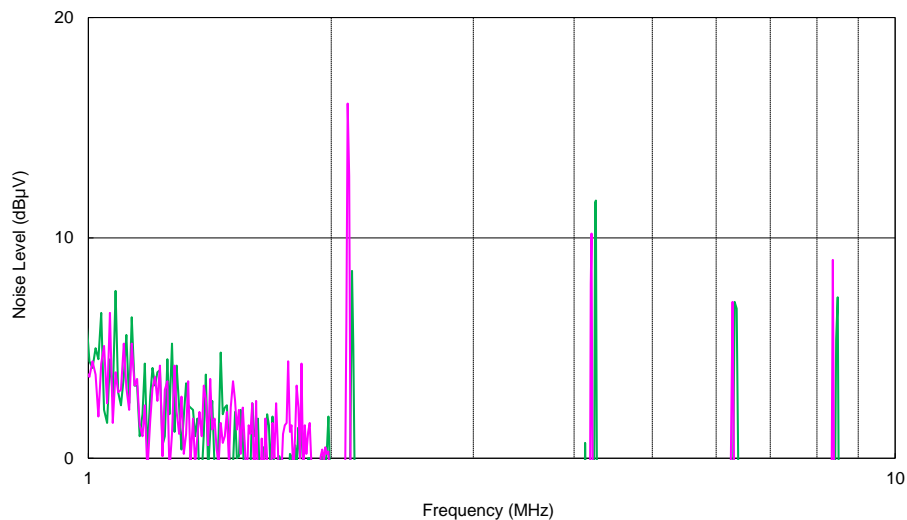

Figure 11. Average Measurement of Differential Mode

4.2 Common-Mode: Conducted EMI Comparison Between Same Phase and Phase Shift

Figure 12 and Figure 13 show the common-mode EMI performance, for peak and average measurements, respectively. The red line shows the data in the same-phase condition, and the green line shows the data in the phase-shift condition. The phase-shift condition can make the common mode performance better in low frequency, but the condition makes the common mode performance worse in high frequency.

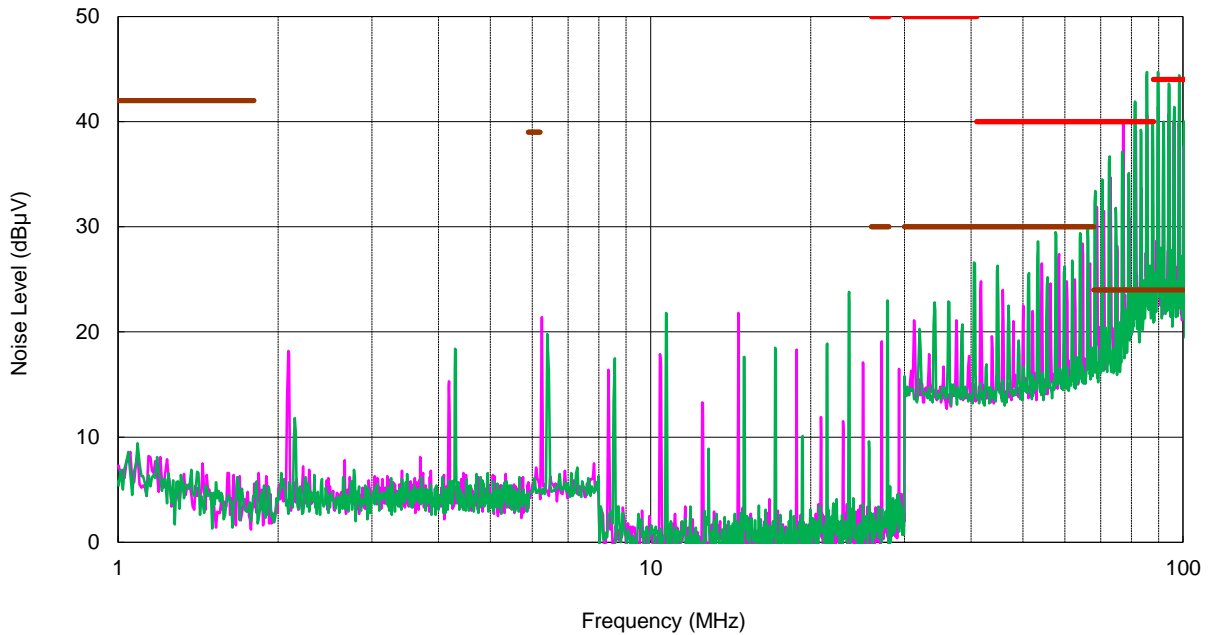

Figure 12. Peak Measurement of Common-Mode

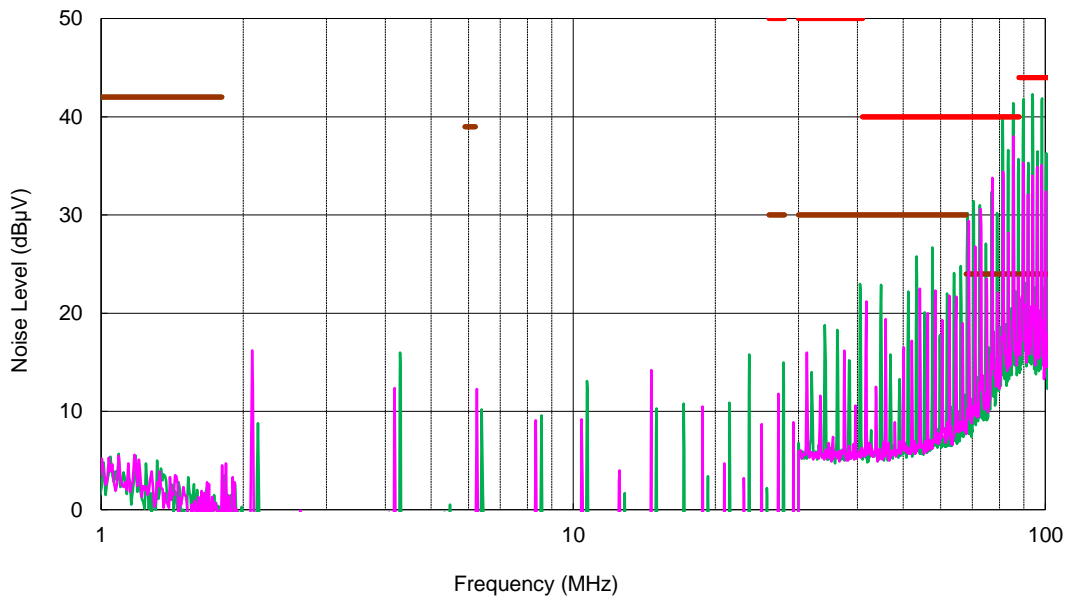

Figure 13. Average Measurement of Common-Mode

5 Conducted EMI Comparison Between Free-Run Mode and Phase-Shift Mode

Figure 14 and Figure 15 show the conducted EMI comparison for the peak and average measurements, respectively. The red line shows the data in the free-run condition, and the green line shows the data in the phase-shift mode. The phase-shift mode can reduce the first harmonic of the switching frequency, as shown.

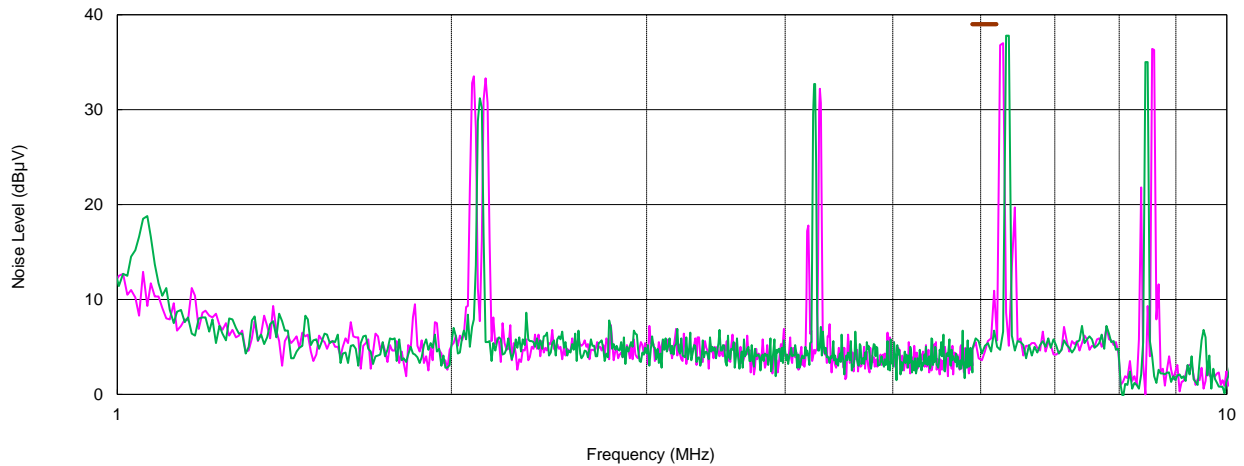

Figure 14. Peak Measurement of Free-Run Mode and Phase-Shift Mode

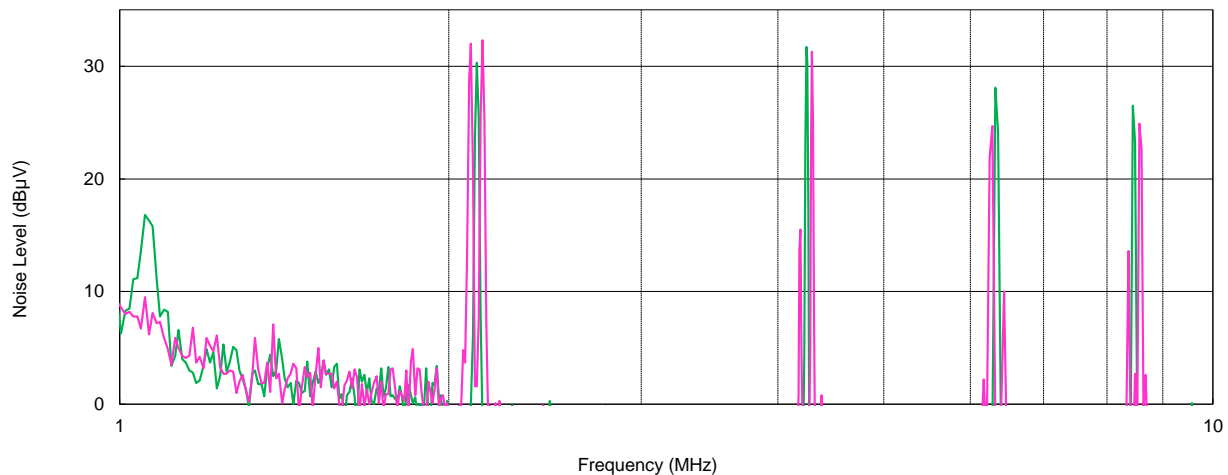

Figure 15. Average Measurement of Free-Run Mode and Phase-Shift Mode

6 Summary

This application note discusses how SYNC logic affects EMI performance on two, independent buck converters. Using the LMR14030 as an example, a dual-channel, buck-converter prototype is built. The phase-shift mode reduces the first harmonic of the switching frequency.

7 References

- Texas Instruments, [How to Extend Buck Regulator to Positive Buck-boost Configuration](#), application report
- Texas Instruments, [LMR14050 SIMPLE SWITCHER® 40 V 5 A, 2.2 MHz Step-Down Converter with 40 \$\mu\$ A IQ](#), data sheet

IMPORTANT NOTICE FOR TI DESIGN INFORMATION AND RESOURCES

Texas Instruments Incorporated ("TI") technical, application or other design advice, services or information, including, but not limited to, reference designs and materials relating to evaluation modules, (collectively, "TI Resources") are intended to assist designers who are developing applications that incorporate TI products; by downloading, accessing or using any particular TI Resource in any way, you (individually or, if you are acting on behalf of a company, your company) agree to use it solely for this purpose and subject to the terms of this Notice.

TI's provision of TI Resources does not expand or otherwise alter TI's applicable published warranties or warranty disclaimers for TI products, and no additional obligations or liabilities arise from TI providing such TI Resources. TI reserves the right to make corrections, enhancements, improvements and other changes to its TI Resources.

You understand and agree that you remain responsible for using your independent analysis, evaluation and judgment in designing your applications and that you have full and exclusive responsibility to assure the safety of your applications and compliance of your applications (and of all TI products used in or for your applications) with all applicable regulations, laws and other applicable requirements. You represent that, with respect to your applications, you have all the necessary expertise to create and implement safeguards that (1) anticipate dangerous consequences of failures, (2) monitor failures and their consequences, and (3) lessen the likelihood of failures that might cause harm and take appropriate actions. You agree that prior to using or distributing any applications that include TI products, you will thoroughly test such applications and the functionality of such TI products as used in such applications. TI has not conducted any testing other than that specifically described in the published documentation for a particular TI Resource.

You are authorized to use, copy and modify any individual TI Resource only in connection with the development of applications that include the TI product(s) identified in such TI Resource. NO OTHER LICENSE, EXPRESS OR IMPLIED, BY ESTOPPEL OR OTHERWISE TO ANY OTHER TI INTELLECTUAL PROPERTY RIGHT, AND NO LICENSE TO ANY TECHNOLOGY OR INTELLECTUAL PROPERTY RIGHT OF TI OR ANY THIRD PARTY IS GRANTED HEREIN, including but not limited to any patent right, copyright, mask work right, or other intellectual property right relating to any combination, machine, or process in which TI products or services are used. Information regarding or referencing third-party products or services does not constitute a license to use such products or services, or a warranty or endorsement thereof. Use of TI Resources may require a license from a third party under the patents or other intellectual property of the third party, or a license from TI under the patents or other intellectual property of TI.

TI RESOURCES ARE PROVIDED "AS IS" AND WITH ALL FAULTS. TI DISCLAIMS ALL OTHER WARRANTIES OR REPRESENTATIONS, EXPRESS OR IMPLIED, REGARDING TI RESOURCES OR USE THEREOF, INCLUDING BUT NOT LIMITED TO ACCURACY OR COMPLETENESS, TITLE, ANY EPIDEMIC FAILURE WARRANTY AND ANY IMPLIED WARRANTIES OF MERCHANTABILITY, FITNESS FOR A PARTICULAR PURPOSE, AND NON-INFRINGEMENT OF ANY THIRD PARTY INTELLECTUAL PROPERTY RIGHTS.

TI SHALL NOT BE LIABLE FOR AND SHALL NOT DEFEND OR INDEMNIFY YOU AGAINST ANY CLAIM, INCLUDING BUT NOT LIMITED TO ANY INFRINGEMENT CLAIM THAT RELATES TO OR IS BASED ON ANY COMBINATION OF PRODUCTS EVEN IF DESCRIBED IN TI RESOURCES OR OTHERWISE. IN NO EVENT SHALL TI BE LIABLE FOR ANY ACTUAL, DIRECT, SPECIAL, COLLATERAL, INDIRECT, PUNITIVE, INCIDENTAL, CONSEQUENTIAL OR EXEMPLARY DAMAGES IN CONNECTION WITH OR ARISING OUT OF TI RESOURCES OR USE THEREOF, AND REGARDLESS OF WHETHER TI HAS BEEN ADVISED OF THE POSSIBILITY OF SUCH DAMAGES.

You agree to fully indemnify TI and its representatives against any damages, costs, losses, and/or liabilities arising out of your non-compliance with the terms and provisions of this Notice.

This Notice applies to TI Resources. Additional terms apply to the use and purchase of certain types of materials, TI products and services. These include; without limitation, TI's standard terms for semiconductor products (<http://www.ti.com/sc/docs/stdterms.htm>), [evaluation modules](#), and [samples](http://www.ti.com/sc/docs/sampterm.htm) (<http://www.ti.com/sc/docs/sampterm.htm>).

Mailing Address: Texas Instruments, Post Office Box 655303, Dallas, Texas 75265
Copyright © 2018, Texas Instruments Incorporated