

LMZ1050x / LMZ1050xEXT SIMPLE SWITCHER® Power Module - Quick Compensation Design

Yang Zhang, Akshay Mehta

ABSTRACT

The LMZ1050x is fully supported by WEBENCH®, which is the fastest way to design a complete power solution, including loop compensation. This application note provides the power supply designer with more detailed design information for stabilizing the LMZ1050x using any type of output capacitor material. The LMZ1050x can achieve stability with a wide range of output capacitances (C_o) and equivalent series resistance (ESR).

Contents

1	Introduction	2
2	Simplified Compensation Equations.....	3
3	Compensation Equation Background	4
4	Conclusion	8

List of Figures

1	Typical Application Schematic	3
2	Complete Loop Gain Schematic	4
3	Power Stage Gain	5
4	Compensation Stage Gain	6
5	Complete Loop Gain	6
6	Power Stage Phase	7
7	Compensation Stage Phase	7
8	Complete Loop Phase	8

List of Tables

1	LMZ10505/LMZ10504 Compensation Component Values.....	2
2	LMZ10503 Compensation Component Values	3

Trademarks

SIMPLE SWITCHER, WEBENCH are registered trademarks of Texas Instruments. All other trademarks are the property of their respective owners.

1 Introduction

Feedback loop system stability is one of the most important design aspects of switching power supplies. Stabilizing the feedback loop requires control theory knowledge and its design can be an intimidating and daunting task. Fortunately, the LMZ1050x simplifies the compensation design by integrating type II compensation that reduces the number of external compensation components to two. A few equations can be used to easily optimize transient performance and stability for any application.

Below are several equations to quickly calculate the compensation components for the LMZ1050x. [Section 3](#) is background information showing how these equations were derived. [Table 1](#) and [Table 2](#) are included for quick component selection in common applications.

Table 1. LMZ10505/LMZ10504 Compensation Component Values

V_{IN} (V)	C_o (μ F)	ESR (m Ω)		R_{fbt} (k Ω)	C_{comp} (pF)	R_{comp} (k Ω)
		Min	Max			
5.0	22	2	20	200	27	1.5
	47	2	20	124	68	1.4
	100	1	10	82.5	150	0.681
	150	1	5	63.4	220	1
	150	10	25	63.4	220	3.48
	150	26	50	226	62	12.1
	220	15	30	150	100	6.98
	220	31	60	316	560	14
3.3	22	2	20	118	43	9.09
	47	2	20	76.8	100	3.32
	100	1	10	49.9	180	2.49
	150	1	5	40.2	330	1
	150	10	25	43.2	330	4.99
	150	26	50	143	100	7.5
	220	15	30	100	180	4.99
	220	31	60	200	100	8.06

Table 2. LMZ10503 Compensation Component Values

V_{IN} (V)	C_o (μ F)	ESR (m Ω)		R_{fbt} (k Ω)	C_{comp} (pF)	R_{comp} (k Ω)
		Min	Max			
5.0	22	2	20	150	47	1
	47	2	20	100	100	4.53
	100	1	10	71.5	180	2
	150	1	5	56.2	270	0.499
	150	10	25	100	180	4.53
	150	26	50	182	100	8.25
	220	15	30	133	160	4.99
	220	31	60	200	100	6.98
3.3	22	2	20	100	56.2	5.62
	47	2	20	76.8	120	3.32
	100	1	10	49.9	220	1
	150	1	5	40.2	430	1
	150	10	25	43.2	390	3.32
	150	26	50	100	180	4.53
	220	15	30	80.6	240	3.32
	220	31	60	140	150	4.99

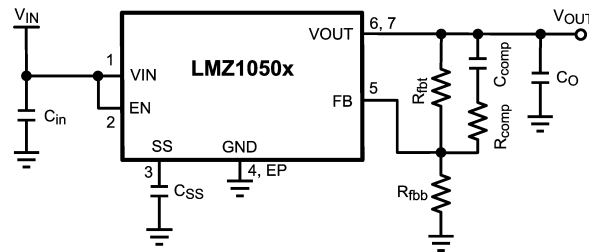
Figure 1. Typical Application Schematic

2 Simplified Compensation Equations

For the voltage mode architecture, we know

$$f_{LC} = \frac{1}{2 \times \pi \times \sqrt{L \times C_o}} \quad (1)$$

To counter this double pole we place the zero caused by C_{comp} , R_{fbt} , and R_{comp} at this frequency. There is one additional zero caused by R_{CINT} of 100 k Ω and C_{CINT} of 90 pF (internal compensation components) at 17.6 kHz as shown in Figure 4. Therefore,

$$f_{zeroext} = f_{LC} \quad (2)$$

$$f_{LC} = \frac{1}{2 \times \pi \times C_{comp} \times (R_{fbt} + R_{comp})} \quad (3)$$

And,

$$f_{pole} = \frac{1}{2 \times \pi \times R_{comp} \times C_{comp}} \quad (4)$$

f_{pole} is the pole frequency caused by the R_{comp} and C_{comp} components. Placing this pole is important for good response and also good gain margin. This pole also counters the effect of the ESR zero. In this methodology, we place the f_{pole} at 200 kHz when the f_{ESR} is less than 200 kHz. For f_{ESR} greater than 200 kHz, the f_{pole} is kept at f_{ESR} as shown in Equation 5.

$$f_{pole} = 200\text{kHz}; f_{ESR} \leq 200\text{kHz}$$

$$f_{pole} = f_{ESR}; f_{ESR} > 200\text{kHz}$$

(5)

Equation 6 provides a quick calculation for the upper feedback resistor R_{fbt} .

$$R_{fbt} = \frac{RC_{INT} \times \left(1 + \frac{f_x}{f_{LC}}\right) \times V_{IN} \times \sqrt{1 + \left(\frac{f_x}{f_{ESR}}\right)^2}}{\sqrt{\left(1 + \left(\frac{f_x}{f_{LC}}\right)^2\right)^2 + \left(\frac{f_x}{Q \times f_{LC}}\right)^2 \times \left(1 + \frac{f_x}{f_{pole}}\right)}}$$

(6)

Where, f_x is the desired crossover frequency shown by Equation 7 and Q is shown by Equation 8

$$f_x = \frac{f_{sw}}{10}$$

(7)

$$Q = \frac{R_{OUT} \times \sqrt{L \times C_O}}{(R_{ESR} \times R_{OUT} \times C_O) + L}$$

(8)

The inductor value L is different per device in the LMZ1050x module family. Please refer to the datasheet to get the value for the required part number. Once we know the upper feedback resistor, calculating the compensation components is easy and is done as follows:

$$R_{comp} = \left(\frac{R_{fbt}}{\frac{f_{pole}}{f_{LC}} - 1} \right)$$

(9)

$$C_{comp} = \frac{1}{2 \times \pi \times f_{LC} \times (R_{fbt} + R_{comp})}$$

(10)

3 Compensation Equation Background

The design approach is to first set the desired crossover frequency, f_x . The f_x is usually set to one-tenth of the switching frequency. Therefore for the devices in the LMZ1050X family, the f_x is set to 100 kHz.

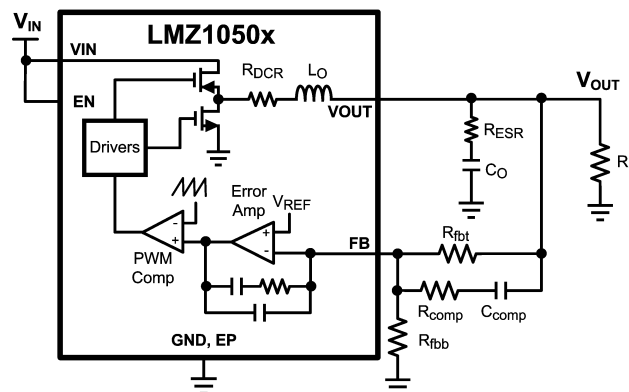

Figure 2. Complete Loop Gain Schematic

Next we need to understand the uncompensated L- C_O tank loop response. This response will depend on the input voltage, internal ramp amplitude, L and C_O values and their parasitic values. From Equation 7 we know what our desired crossover frequency will be. The first step to design the compensating element values we need to know the amount of gain that is required to be added. We know that the overall gain of the system at crossover is 0 dB. This means that we need to add as much gain as the power stage is below zero at crossover frequency. E.g. in the Power Stage Gain plot in Figure 3, assuming the desired crossover frequency is 100 kHz, the gain at the desired crossover frequency is about -22 dB. This means that the compensator needs to add about 17 dB at crossover to obtain the desired crossover.

In most cases access to the power stage gain is not available. Therefore we need to calculate the power stage gain analytically. The power stage gain is shown as follows

$$Gain = 20 \times \log_{10} \left(\frac{V_{IN}}{V_{RAMP}} \right) + 10 \times \log_{10} \left(1 + \left(\frac{f_X}{f_{ESR}} \right)^2 \right) - 10 \times \log_{10} \left(\left(1 + \left(\frac{f_X}{f_{LC}} \right)^2 \right)^2 + \left(\frac{f_X}{Q \times f_{LC}} \right)^2 \right) \quad (11)$$

This gain is what needs to be added in order to obtain the desired crossover. At crossover frequency, this gain should be negative. Therefore negating it would give the positive gain required to be added.

The LMZ1050X has partial internal compensation. The R_{CINT} and C_{CINT} are internal components. This means that the upper feedback resistor can now be calculated based on the known internal compensation values. But since this device employs voltage mode control architecture, type III compensation is almost inevitable. Therefore along with the internal compensation components, the external compensation components need to be considered too.

$$10^{\frac{-Gain}{20}} = R_{CINT} \times \frac{\left(1 + (2 \times \pi \times f_X \times C_{comp} \times (R_{comp} + R_{fbt})) \right)}{R_{fbt} \times \left(1 + (2 \times \pi \times f_X \times C_{comp} \times R_{comp}) \right)} \quad (12)$$

We can now re-write Equation 12 for R_{fbt} .

$$R_{fbt} = \frac{R_{CINT} + (2 \times \pi \times f_X \times C_{comp} \times R_{comp} \times R_{CINT})}{10^{\frac{-Gain}{20}} \times \left(1 + (2 \times \pi \times f_X \times C_{comp} \times R_{comp}) \right) - (2 \times \pi \times f_X \times C_{comp} \times R_{CINT})} \quad (13)$$

Equation 11 and Equation 13 then can be simplified to obtain Equation 6

These are the basic guidelines to calculate the compensation components. Additionally depending on the choice of output capacitors and whether the parasitic information is known or not, it might be required to tweak the component values to get a good loop response.

Furthermore the equations listed in this application note are designed for a single output capacitor or, in other words, capacitors of the same type. For a mixed type of capacitors at the output, the above equations do not hold. The figures shown below depict the compensation strategy as explained above.

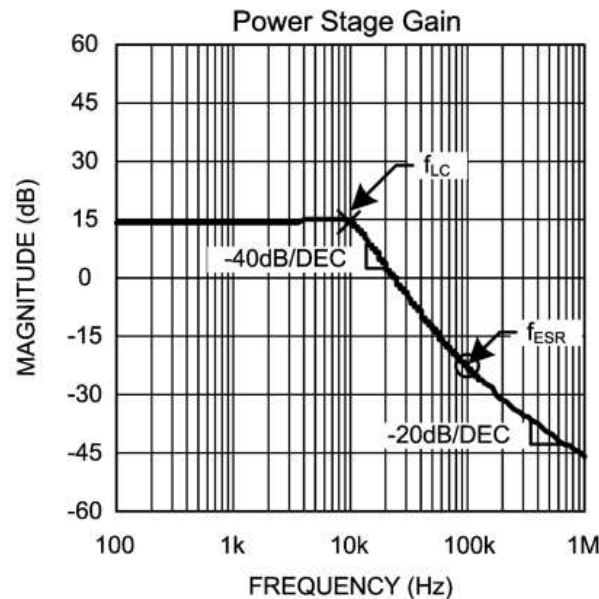

Figure 3. Power Stage Gain

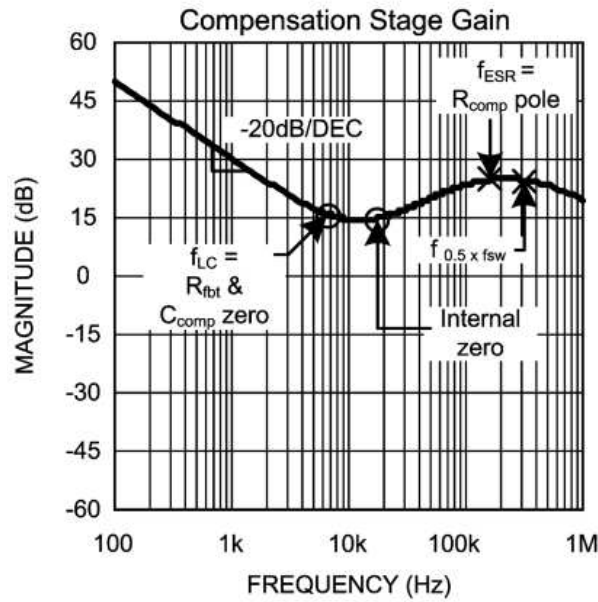

Figure 4. Compensation Stage Gain

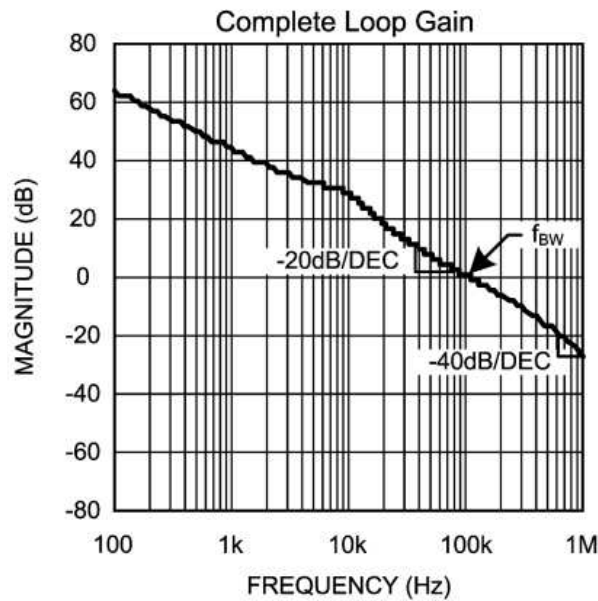

Figure 5. Complete Loop Gain

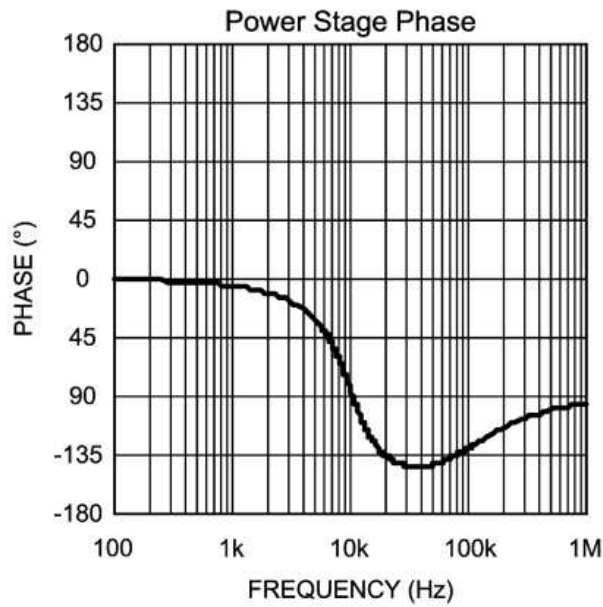

Figure 6. Power Stage Phase

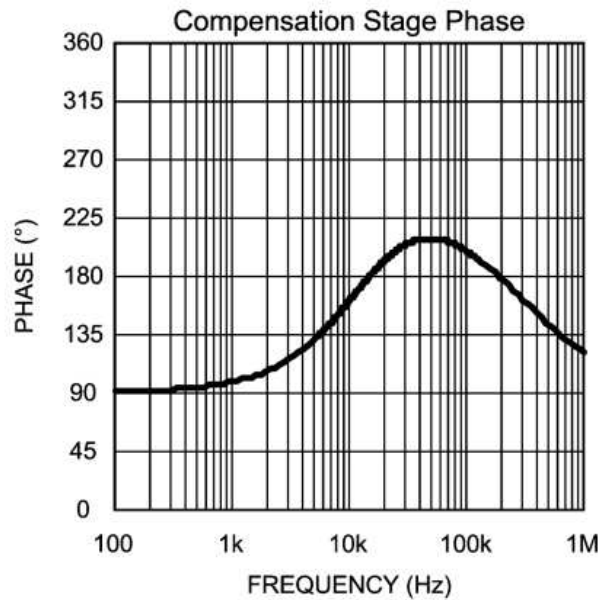

Figure 7. Compensation Stage Phase

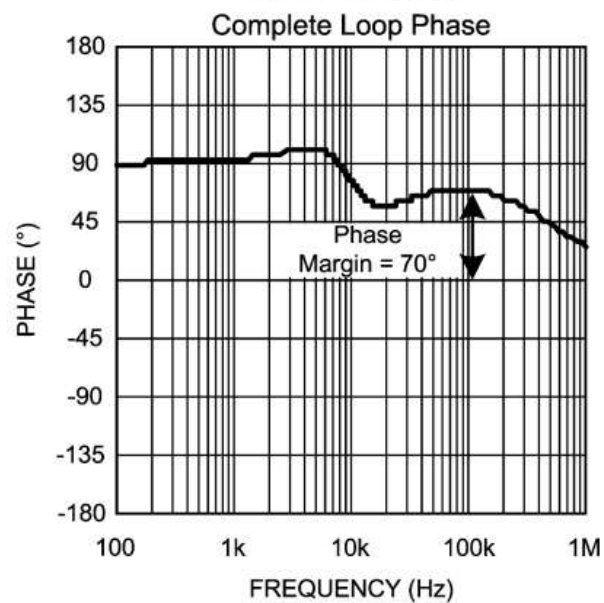

Figure 8. Complete Loop Phase

4 Conclusion

The LMZ1050x provides simplified type III compensation for the voltage mode control architecture and is flexible enough to allow all types of output capacitor material designs. The LMZ1050x is well balanced to support a wide range of R_{ESR} and C_O values while reducing the number of compensation components to two. For the device-specific data sheet, WEBENCH, evaluation board, application report, and reference design information go to: <http://www.ti.com/product/LMZ10504>

Revision History

NOTE: Page numbers for previous revisions may differ from page numbers in the current version.

Changes from D Revision (April 2013) to E Revision	Page
• Changed all the contents from the previous version	5

IMPORTANT NOTICE FOR TI DESIGN INFORMATION AND RESOURCES

Texas Instruments Incorporated ("TI") technical, application or other design advice, services or information, including, but not limited to, reference designs and materials relating to evaluation modules, (collectively, "TI Resources") are intended to assist designers who are developing applications that incorporate TI products; by downloading, accessing or using any particular TI Resource in any way, you (individually or, if you are acting on behalf of a company, your company) agree to use it solely for this purpose and subject to the terms of this Notice.

TI's provision of TI Resources does not expand or otherwise alter TI's applicable published warranties or warranty disclaimers for TI products, and no additional obligations or liabilities arise from TI providing such TI Resources. TI reserves the right to make corrections, enhancements, improvements and other changes to its TI Resources.

You understand and agree that you remain responsible for using your independent analysis, evaluation and judgment in designing your applications and that you have full and exclusive responsibility to assure the safety of your applications and compliance of your applications (and of all TI products used in or for your applications) with all applicable regulations, laws and other applicable requirements. You represent that, with respect to your applications, you have all the necessary expertise to create and implement safeguards that (1) anticipate dangerous consequences of failures, (2) monitor failures and their consequences, and (3) lessen the likelihood of failures that might cause harm and take appropriate actions. You agree that prior to using or distributing any applications that include TI products, you will thoroughly test such applications and the functionality of such TI products as used in such applications. TI has not conducted any testing other than that specifically described in the published documentation for a particular TI Resource.

You are authorized to use, copy and modify any individual TI Resource only in connection with the development of applications that include the TI product(s) identified in such TI Resource. NO OTHER LICENSE, EXPRESS OR IMPLIED, BY ESTOPPEL OR OTHERWISE TO ANY OTHER TI INTELLECTUAL PROPERTY RIGHT, AND NO LICENSE TO ANY TECHNOLOGY OR INTELLECTUAL PROPERTY RIGHT OF TI OR ANY THIRD PARTY IS GRANTED HEREIN, including but not limited to any patent right, copyright, mask work right, or other intellectual property right relating to any combination, machine, or process in which TI products or services are used. Information regarding or referencing third-party products or services does not constitute a license to use such products or services, or a warranty or endorsement thereof. Use of TI Resources may require a license from a third party under the patents or other intellectual property of the third party, or a license from TI under the patents or other intellectual property of TI.

TI RESOURCES ARE PROVIDED "AS IS" AND WITH ALL FAULTS. TI DISCLAIMS ALL OTHER WARRANTIES OR REPRESENTATIONS, EXPRESS OR IMPLIED, REGARDING TI RESOURCES OR USE THEREOF, INCLUDING BUT NOT LIMITED TO ACCURACY OR COMPLETENESS, TITLE, ANY EPIDEMIC FAILURE WARRANTY AND ANY IMPLIED WARRANTIES OF MERCHANTABILITY, FITNESS FOR A PARTICULAR PURPOSE, AND NON-INFRINGEMENT OF ANY THIRD PARTY INTELLECTUAL PROPERTY RIGHTS.

TI SHALL NOT BE LIABLE FOR AND SHALL NOT DEFEND OR INDEMNIFY YOU AGAINST ANY CLAIM, INCLUDING BUT NOT LIMITED TO ANY INFRINGEMENT CLAIM THAT RELATES TO OR IS BASED ON ANY COMBINATION OF PRODUCTS EVEN IF DESCRIBED IN TI RESOURCES OR OTHERWISE. IN NO EVENT SHALL TI BE LIABLE FOR ANY ACTUAL, DIRECT, SPECIAL, COLLATERAL, INDIRECT, PUNITIVE, INCIDENTAL, CONSEQUENTIAL OR EXEMPLARY DAMAGES IN CONNECTION WITH OR ARISING OUT OF TI RESOURCES OR USE THEREOF, AND REGARDLESS OF WHETHER TI HAS BEEN ADVISED OF THE POSSIBILITY OF SUCH DAMAGES.

You agree to fully indemnify TI and its representatives against any damages, costs, losses, and/or liabilities arising out of your non-compliance with the terms and provisions of this Notice.

This Notice applies to TI Resources. Additional terms apply to the use and purchase of certain types of materials, TI products and services. These include; without limitation, TI's standard terms for semiconductor products (<http://www.ti.com/sc/docs/stdterms.htm>), [evaluation modules](#), and [samples](http://www.ti.com/sc/docs/sampterm.htm) (<http://www.ti.com/sc/docs/sampterm.htm>).

Mailing Address: Texas Instruments, Post Office Box 655303, Dallas, Texas 75265
Copyright © 2017, Texas Instruments Incorporated