

Interfacing the MSP430AFE25x-Based Single-Phase E-Meter With a Host Processor

Mekre Mesganaw and Kripasagar Venkat

ABSTRACT

This application report describes the implementation of a single-phase electronic electricity meter using the Texas Instruments MSP430AFE25x metrology family of processors in two-chip architecture. The metering processor (MSP430AFE25x) assumes the role of a slave controlled by a host microcontroller (MCU), the MSP430F663x.

Project collateral and source code mentioned in this document can be downloaded from the following URL: <http://www.ti.com/lit/zip/tidc621>.

WARNING

Failure to adhere to these steps or not heed the safety requirements at each step may lead to shock, injury, and damage to the hardware. Texas Instruments is not responsible or liable in any way for shock, injury, or damage caused due to negligence or failure to heed advice.

Contents

| | | |
|---|-------------------------------|----|
| 1 | Introduction | 2 |
| 2 | Block Diagram | 3 |
| 3 | Hardware Implementation | 4 |
| 4 | Software Implementation | 7 |
| 5 | Energy Meter Demo..... | 19 |
| 6 | Results and Calibration | 27 |
| 7 | Read This | 36 |
| 8 | Schematics | 37 |
| 9 | References | 40 |

List of Figures

| | | |
|----|--|----|
| 1 | EVM430-MSP430AFE System Block Diagram | 3 |
| 2 | 1-Phase 2-Wire Connection Using MSP430AFE2x3..... | 4 |
| 3 | A Simple Capacitive Power Supply for the MSP430 Energy Meter | 5 |
| 4 | A Switching-Based Power Supply for the MSP430 Applications Processor | 5 |
| 5 | Analog Front End for Voltage Inputs | 6 |
| 6 | Analog Front End for Current Inputs | 7 |
| 7 | Metrology Foreground Process | 9 |
| 8 | Background Process | 12 |
| 9 | Phase Compensation Using PRELOAD Register..... | 13 |
| 10 | Frequency Measurement..... | 14 |

| | | |
|----|--|----|
| 11 | Pulse Generation for Energy Indication | 15 |
| 12 | Application Software | 16 |
| 13 | Transference of Meter Parameters From AFE to MSP430F663x | 17 |
| 14 | Top View of the EVM | 19 |
| 15 | Top View of the EVM With Blocks and Jumpers | 20 |
| 16 | Top View of the EVM With Test Setup Connections | 21 |
| 17 | Side View of the EVM With Test Setup Connections | 21 |
| 18 | Source Folder Contents | 24 |
| 19 | Toolkit Compilation in IAR..... | 24 |
| 20 | Application Compilation in IAR | 25 |
| 21 | Metrology Compilation in IAR..... | 26 |
| 22 | ZigBee Radio | 28 |
| 23 | TI Designed IHD430 | 28 |
| 24 | Driver Installation Step 3 | 29 |
| 25 | Driver Installation Step 4 | 30 |
| 26 | Driver Installation Step 5 | 30 |
| 27 | Hardware Installation Prompt..... | 31 |
| 28 | Device Manager With EVM Enumerated as COM19..... | 31 |
| 29 | GUI Config File Changed With to EVM COM Port..... | 32 |
| 30 | GUI Startup Window | 32 |
| 31 | Results Window | 33 |
| 32 | Calibration Factors Window..... | 34 |
| 33 | Manual Calibration Window..... | 34 |

List of Tables

| | | |
|---|--|----|
| 1 | Header Names and Jumper Settings on the EVM..... | 22 |
| 2 | Power Supply Selection for MSP430AFE..... | 23 |
| 3 | Description of LCD-Displayed Parameters..... | 27 |

1 Introduction

The MSP430AFE25x devices belong to the MSP430F2xx family of devices. These devices find their application in energy measurement and have the necessary architecture to support it. The MSP430AFE25x, mentioned as MSP430AFE from this point forward, has a powerful 12 MHz CPU with MSP430™ architecture. The analog front end consists of up to three analog-to-digital converters (ADC) based on a second order sigma-delta architecture that supports differential inputs. The sigma-delta ADCs (SD24_A) have capabilities to output 24-bit results. They can be grouped together for simultaneous sampling of voltage and currents on the same trigger. In addition, each $\Sigma\Delta$ has an integrated gain amplifier (with gains up to 32) for amplification of low-output sensors. A 16-bit x 16-bit hardware multiplier on this chip is used to further accelerate math intensive operations required for metrology parameters. The programmable software on the MSP430AFE supports calculation of various parameters for single phase energy measurement with tamper detection. The key parameters calculated during energy measurements are: RMS current and voltage, Active, Reactive, and apparent power and energies, power factor and frequency.

The MSP430F663x, the host processor in this 2-chip architecture, has a powerful 20 MHz CPU with MSP430 architecture. The MSP430F663x contains a full-speed Universal Serial Bus (USB), integrated LCD driver with contrast control for up to 160 segments, a hardware real-time clock with battery back-up system, multiple timers and serial communication interfaces. This device, with large on-chip memory is best-suited as an application processor to interface to any low-cost metrology processor such as the MSP430AFE.

MSP430 is a trademark of Texas Instruments.
IAR Embedded Workbench is a registered trademark of IAR Systems AB.
All other trademarks are the property of their respective owners.

2 Block Diagram

Figure 1 shows a high-level system block diagram of the reference EVM (EVM430-AFE253) from Texas Instruments, which is divided into a metrology portion that has the MSP430AFE and the application portion that has the MSP430F663x. The MSP430AFE is a slave metrology processor and the MSP430F663x is the host and application processor. Isolated inter-processor communication is made possible using digital isolators on the serial peripheral interface (SPI) and universal asynchronous receiver/transmitter (UART) pins.

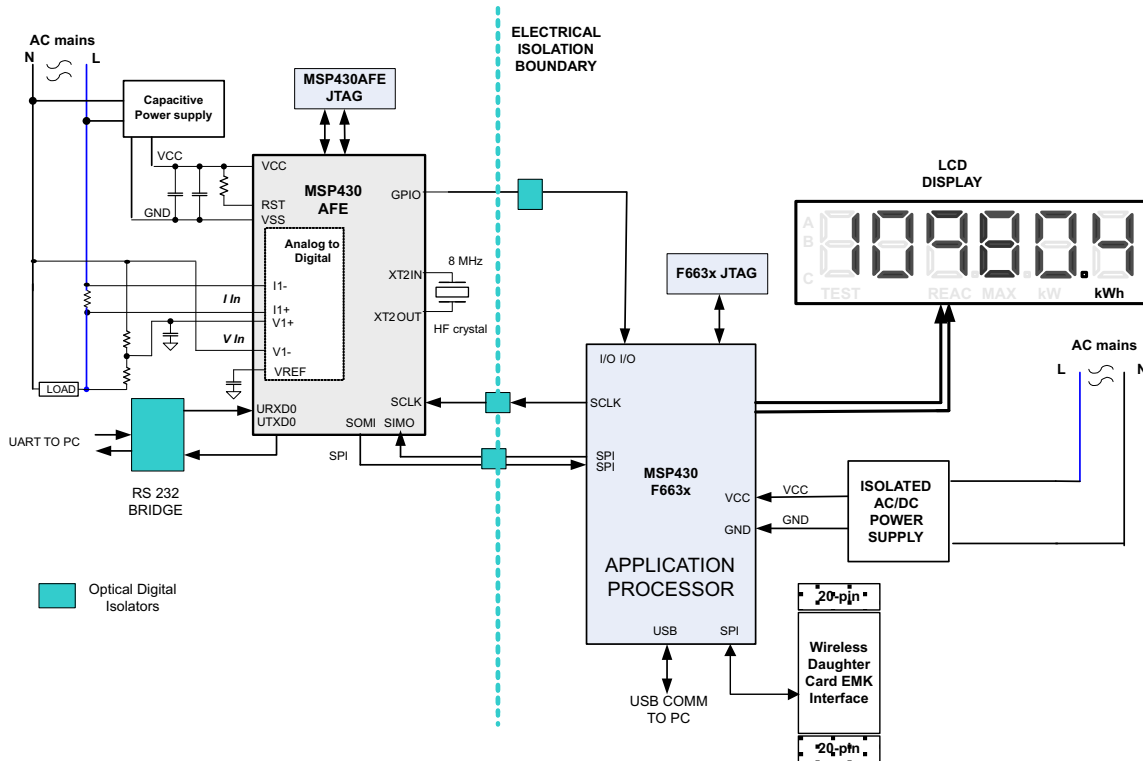

Figure 1. EVM430-MSP430AFE System Block Diagram

Figure 2 shows the high-level interface with MSP430 used for a single-phase energy meter application. A single-phase two wire connection to the mains is shown in this case with tamper detection. Current sensors are connected to each of the current channels and a simple voltage divider is used for corresponding voltages. The CT has an associated burden resistor that must be connected at all times to protect the measuring device. The choice of the CT and the burden resistor is done based on the manufacturer and current range required for energy measurements. The choice of the shunt resistor value is determined by the current range, gain settings of the SD24_A on the AFE and the tolerance of the power dissipation. The choice of voltage divider resistors for the voltage channel is selected to ensure the mains voltage is divided down to adhere to the normal input ranges that are valid for the MSP430 SD24_A. For these limits, see the *MSP430x2xx Family User's Guide* (SLAU144) and *MSP430AFE2x3, MSP430AFE2x2, MSP430AFE2x1 Mixed Signal Microcontroller Data Sheet* (SLAS701).

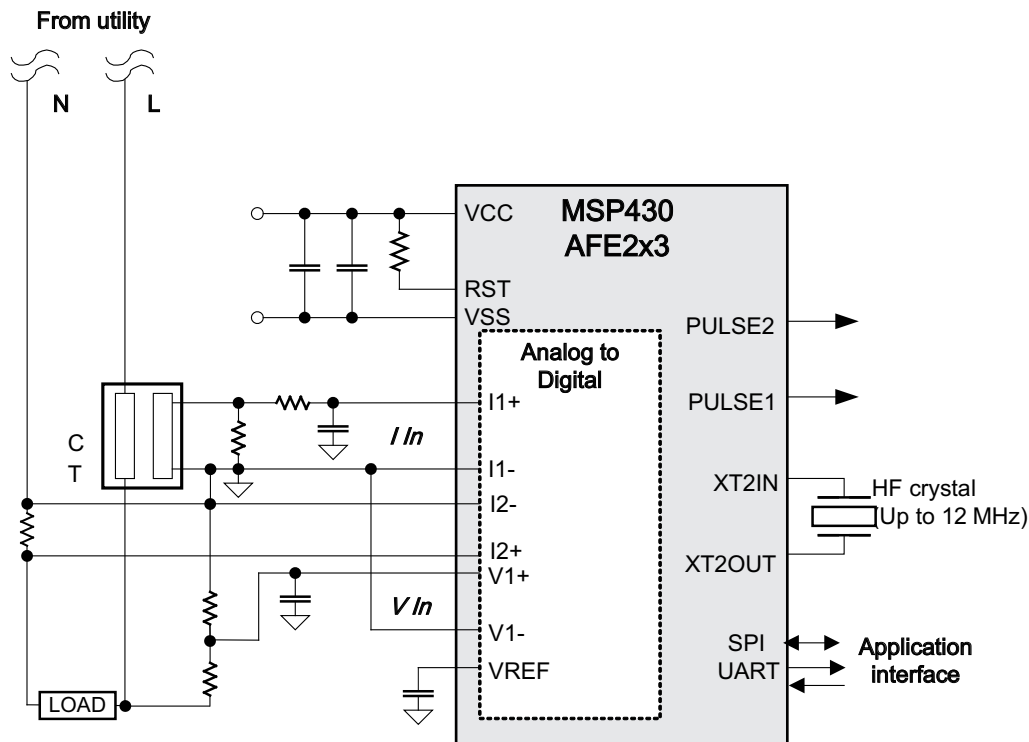

Figure 2. 1-Phase 2-Wire Connection Using MSP430AFE2x3

3 Hardware Implementation

This section describes the front-end passives and other components required for the design of an energy meter using the MSP430AFE.

3.1 Power Supply

The MSP430 family of microcontrollers support a number of low-power modes in addition to low-power consumption during active (measurement) mode when the CPU and other peripherals are active. Since an energy meter is always interfaced to the AC mains, the DC supply required for the measuring element (MSP430AFE) can be easily derived using an AC to DC conversion mechanism.

The reduced power requirements of this device family allow design of power supplies to be small, extremely simple and cost-effective. The power supply allows the operation of the energy meter by being powered directly from the mains. The next sub-sections discuss the various power supply options that are available to you to support your design.

3.1.1 Resistor Capacitor (RC) Power Supply

Figure 3 shows a simple capacitor power supply that supplies a regulated output voltage of 3.3 V using the mains AC voltage of 110 V-230 V.

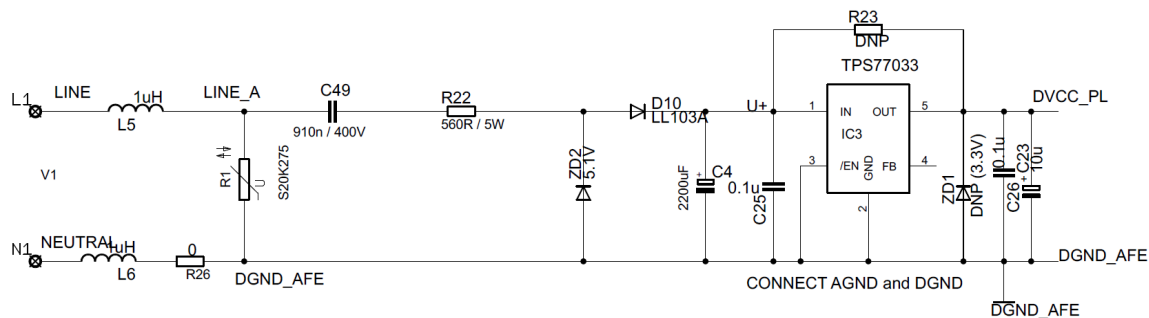

Figure 3. A Simple Capacitive Power Supply for the MSP430 Energy Meter

Appropriate values of resistor R22 and capacitor C49 are chosen based on the required output current-drive of the power supply. Voltage from mains is directly fed to a RC-based circuit followed by a rectification circuitry to provide a DC voltage for the operation of the MSP430. This DC voltage is regulated to 3.3 V for full speed operation of the MSP430. For the circuit above, the drive provided is approximately 25 mA. The design equations for the power supply are given in the *Capacitor Power Supplies* section of *MSP430 Family Mixed-Signal Microcontroller (SLAA024)*. If a need for additional drive is required, either an NPN output buffer or a transformer/switching-based power supply maybe used.

3.1.2 Switching-Based Power Supply

When high current drive is required to drive RF transceivers, a simple capacitive power supply does not provide enough peak-current. Hence, a switching-based power supply is required. A separate power supply module on the board can be used to provide 3.3 V DC from the AC mains of 110 V – 230 V AC. Figure 4 shows the use of an SMPS module to provide a 3.3 V rail with increased current drive. This module is used on the EVM430-AFE253 to provide an isolated voltage to drive only the MSP430F663x and its associated interfaces.

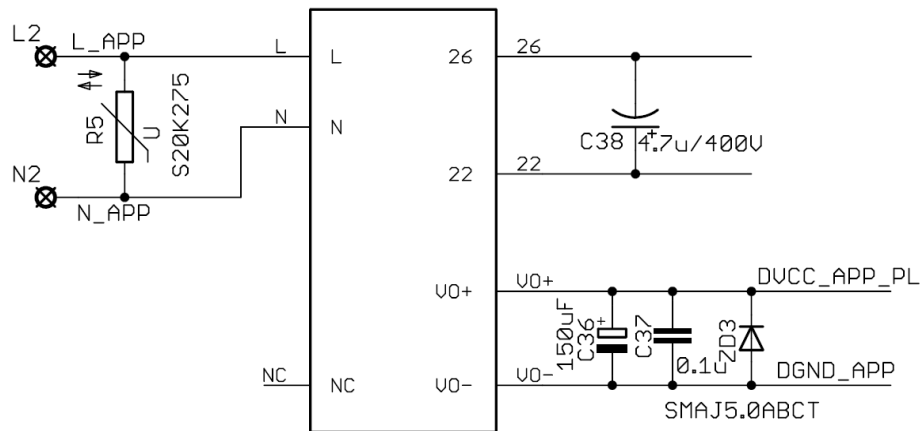

Figure 4. A Switching-Based Power Supply for the MSP430 Applications Processor

3.2 Analog Inputs

The MSP430AFE's analog front end, which consists of the $\Sigma\Delta$ ADC, is differential and requires that the input voltages at the pins do not exceed ± 500 mV (gain = 1). In order to meet this specification, the current and voltage inputs need to be scaled down. In addition, since the SD24_A allows negative voltage of up to -1 V; AC mains signals can be directly interfaced without the need for level shifters. This subsection describes the analog front end used for voltage and current channels.

3.2.1 Voltage Inputs

The voltage from the mains is usually 230 V or 110 V and needs to be scaled down to a range of 500 mV. The analog front end for voltage consists of spike protection varistors (not shown) followed by a simple voltage divider and a RC low-pass filter that acts like an anti-alias filter.

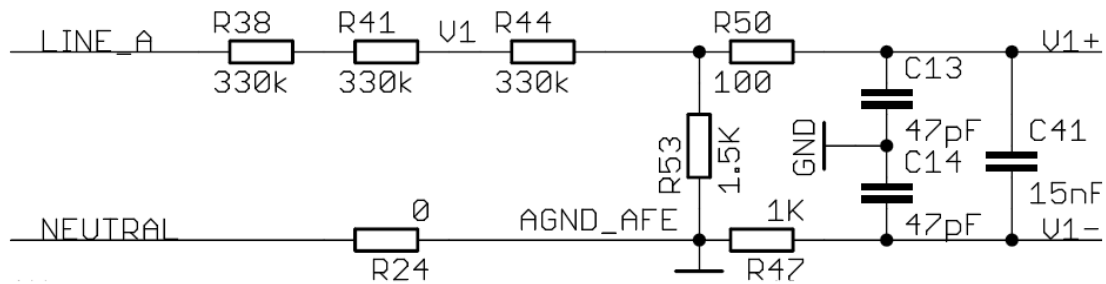

Figure 5. Analog Front End for Voltage Inputs

Figure 5 shows the analog front end for the voltage inputs for a mains voltage of 230V. The voltage is brought down to approximately 350 mV RMS, which is 495 mV peak and fed to the positive input, adhering to the MSP430 $\Sigma\Delta$ analog limits. A common mode voltage of zero can be connected to the negative input of the $\Sigma\Delta$.

It is important to note that the anti-alias resistors on the positive and negative sides are different because the input impedance to the positive terminal is much higher; therefore, a lower value resistor is used for the anti-alias filter. If this is not maintained, a relatively large phase shift would result between voltage and current samples.

3.2.2 Current Inputs

The analog front end for current inputs is a little different from the analog front end for the voltage inputs. Figure 6 shows the analog front end used for current channel I1 and I2.

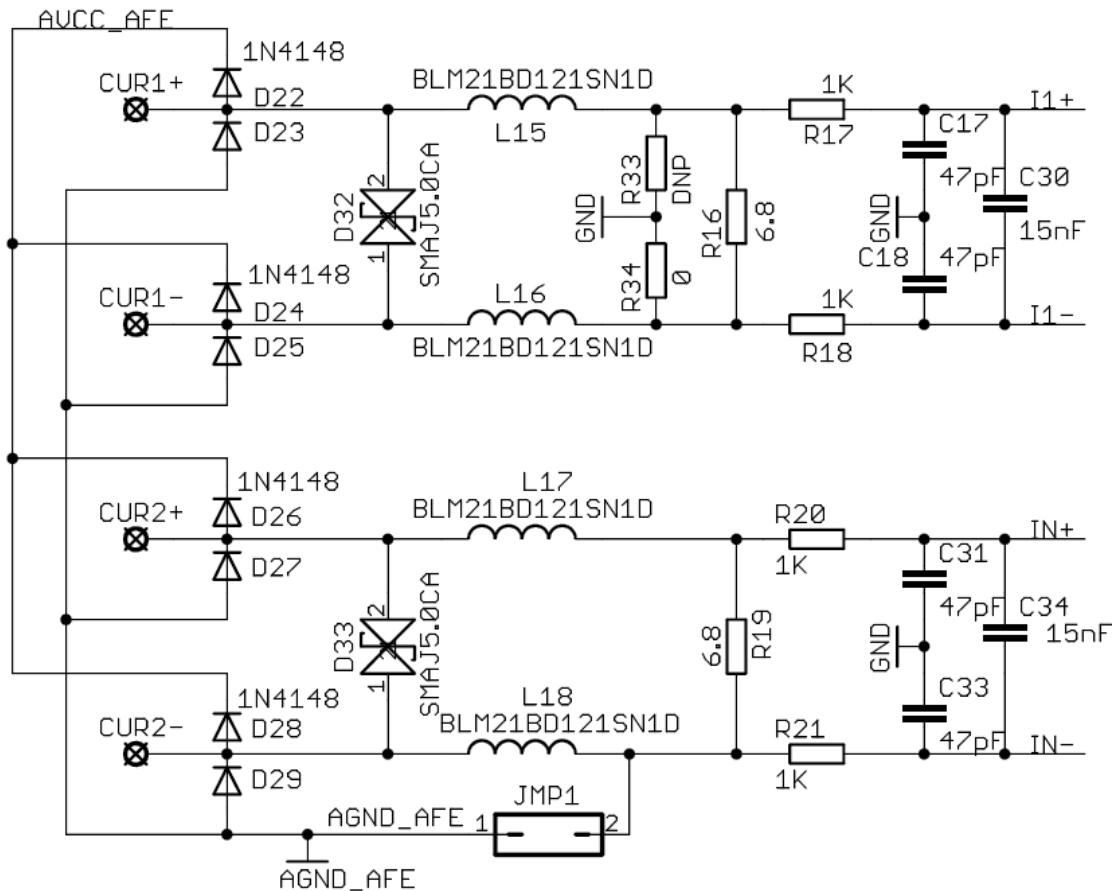

Figure 6. Analog Front End for Current Inputs

Resistor R16 is the burden resistor that would be selected based on the current range used and the turns-ratio specification of the CT (not required if shunt resistors are used as current sensors). The value of the burden resistor for this design is around 6.8 Ω . The anti-aliasing circuitry consisting of R and C follows the burden resistor. The input signal to the converter is a fully differential input with a voltage swing of ± 500 mV maximum with gain of the converter set to 1.

4 Software Implementation

The software for the implementation of 1-phase metrology is discussed in this section. Section 4.1 discusses the setup of various peripherals of the metrology and application processors. In Section 4.2 and Section 4.3, the metrology software is described as two major processes: the foreground process and background process. In Section 4.4, the application software is described in detail. Subsequently, the process of how the MSP430F663x receives metering parameters from the AFE is described.

4.1 Peripherals Setup

The major peripherals of the MSP430AFE are the 24-bit sigma delta (SD24_A) ADC, clock system, watchdog timer (WDT), and so forth. For the MSP430F663x, the major peripherals of are the clock system, timer, USB, LCD, Watchdog Timer (WDT) and SPI (USCI).

4.1.1 AFE SD24_A Setup

The MSP430AFE has up to three independent sigma delta data converters. For a single phase system, at least two $\Sigma\Delta$ s are necessary to independently measure one voltage and current. The code accompanying this application note will address the metrology for a 1-phase system with limited discussion to anti-tampering. The clock to the SD24_A () is derived from an external crystal 8 MHz external crystal (ACLK).

The sampling frequency is defined as $f_s = \frac{f_M}{OSR}$, the OSR is chosen to be 256 and the modulation frequency f_M , is chosen as 1 MHz, resulting in a sampling frequency of 3906 Hz. The SD24_As are configured to generate regular interrupts every sampling instant.

The following are the $\Sigma\Delta$ channels associations:

- A0.0 + and A0.0- → Current I1
- A1.0 + and A1.0- → Current I2 (Neutral)
- A2.0 + and A2.0- → Voltage V1

4.1.2 AFE Main Clock Setup

The MSP430AFE supports an external high-frequency crystal with frequencies of up to 12 MHz. In this EVM, an 8 MHz crystal is used and MCLK is sourced from this external crystal.

4.1.3 AFE UART/SPI Setup

The MSP430F6638, the master and MSP430AFE, the slave communicate via SPI. In this application, the SPI is configured in 8-bit, 3-wire mode with SPI clock set at 1 MHz.

4.1.4 F6638 Main Clock Setup

The MSP430F6638 supports external low-frequency or external high-frequency crystals. In this EVM, an 8 MHz high frequency crystal is used and MCLK is sourced from this crystal. In addition, a low-frequency 32768 Hz crystal is used as ACLK to source the real time clock and LCD.

4.1.5 F6638 Real-Time Clock (RTC_B)

The RTC_B is a real-time clock module that is configured to give precise 1 second interrupts. Based off these one second interrupts, the time and date are updated in the software, as necessary.

4.1.6 F6638 LCD Controller (LCD_B)

The LCD controller on the MSP430F6638 can support up to 4-mux displays and 160 segments. In the current design, the LCD controller is configured to work in 4-mux mode using 160 segments with a refresh rate set to ACLK/64, which is 512 Hz. For information about the parameters displayed on the LCD, see [Section 6.1](#).

4.2 Metrology Foreground Process

The metrology foreground process includes the initial setup of the MSP430AFE hardware and software immediately after a device RESET. [Figure 7](#) shows the flowchart for this process.

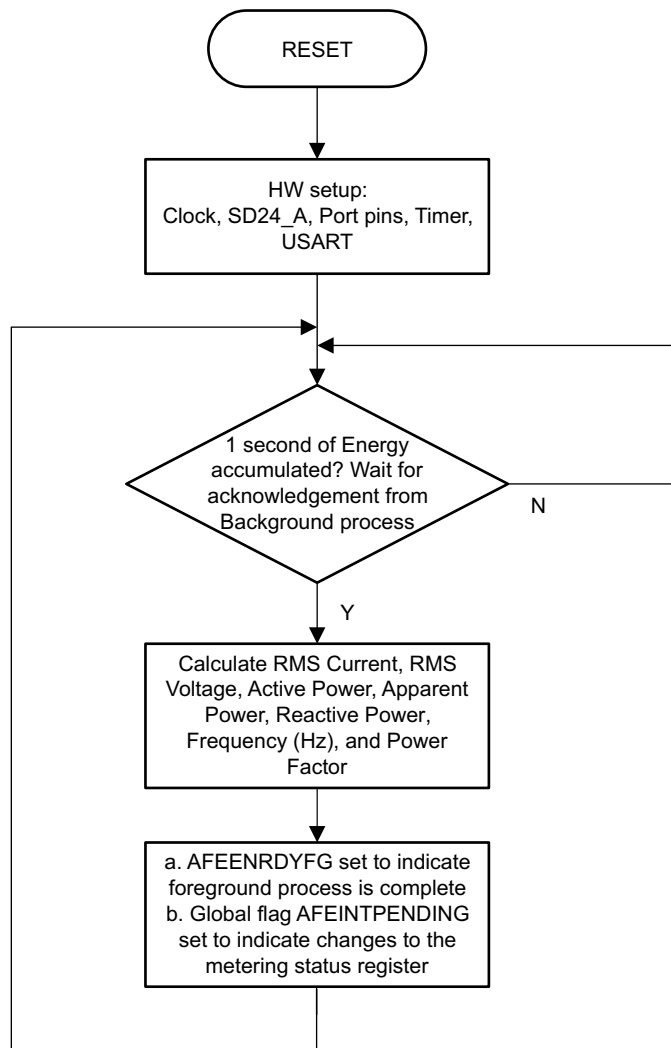

Figure 7. Metrology Foreground Process

The setup routines involve the initialization of the analog-to-digital converter, clock system, general-purpose input/output (GPIO) (port) pins, timer and the UART SPI communication. The MSP430AFE is configured as 8-bit, 3-wire SPI slave. It should be noted that since the UART is configured for SPI, the RS232 communication using UART cannot be used simultaneously.

After the hardware is setup, the foreground process waits for the background process to notify it to calculate new metering parameters. This notification is done through a status flag every time a frame of data is available for processing. The data frame consists of processed current, voltage, active and reactive quantities accumulated for one second. This is equivalent to accumulation of 50 or 60 cycles of data synchronized to the incoming voltage signal. In addition, a sample counter keeps tracks of how many samples have been accumulated over this frame period. This count can vary as the software synchronizes with the incoming mains frequency.

All values are accumulated in separate 48-bit registers to further process and obtain the RMS and mean values during the foreground process. Using the foreground's calculated values of active and reactive power, the apparent power is calculated. The frequency (in Hertz) and power factor are also calculated using parameters calculated by the background process and the formulas in [Section 4.2.1](#). After all the metering parameters are calculated, the AFEENRDYFG metering interrupt flag is asserted high to indicate the completion of the foreground's calculation of the metrology parameters for the current frame.

4.2.1 Formulae

This section briefly describes the formulae used for the voltage, current and energy calculations.

4.2.1.1 Voltage and Current

As discussed in the previous sections, simultaneous voltage and current samples are obtained from three independent $\Sigma\Delta$ converters at a sampling rate of 3906 Hz. The track of the number of samples that are present in one second is kept and used to obtain the RMS values for voltage and for each current via the formulas shown in [Equation 1](#):

$$V_{RMS} = K_V * \sqrt{\frac{\sum_{n=1}^{\text{Sample count}} v(n) * v(n)}{\text{Sample count}}} \quad I_{RMS,ph} = K_{i,ph} * \sqrt{\frac{\sum_{n=1}^{\text{Sample count}} i_{ph}(n) * i_{ph}(n)}{\text{Sample count}}} \quad (1)$$

Where:

- ph = Live or Neutral
- $v(n)$ = Voltage sample at a sample instant n
- $i_{ph}(n)$ = Each current sample at a sample instant n
- $Sample\ count$ = Number of samples in one second
- K_V = Scaling factor for voltage
- $K_{i,ph}$ = Scaling factor for line or neutral current

4.2.1.2 Power and Energy

Power and energy are calculated for a frame's worth of active and reactive energy samples. These samples are phase corrected and passed on to the foreground process, which uses the number of samples (sample count) to calculate total active and reactive powers via the formulas shown in [Equation 2](#):

$$P_{ACT,ph} = K_{ACT,ph} \frac{\sum_{n=1}^{\text{Sample count}} v(n) \times i_{ph}(n)}{\text{Sample count}}$$

$$P_{REACT,ph} = K_{REACT,ph} \frac{\sum_{n=1}^{\text{Sample count}} v_{90}(n) \times i_{ph}(n)}{\text{Sample count}} \quad (2)$$

- $v_{90}(n)$ = Voltage sample at a sample instant 'n' shifted by 90 degrees
- $K_{ACT,ph}$ = Scaling factor for active power
- $K_{REACT,ph}$ = Scaling factor for reactive power

Active energy is calculated from the active power shown in [Equation 3](#):

$$E_{ACT,ph} = P_{ACT,ph} \times \text{Sample count}$$

$$E_{REACT,ph} = P_{REACT,ph} \times \text{Sample count} \quad (3)$$

For reactive energy, the 90° phase shift approach is used for two reasons:

- It allows accurate measurement of the reactive power for very small currents.
- It conforms to the measurement method specified by IEC and ANSI standards.

The calculated mains frequency is used to calculate the 90° shifted voltage sample. Since the frequency of the mains varies, it is important to first measure the mains frequency accurately in order to phase shift the voltage samples accordingly (see [Section 4.3.3](#)).

The application's phase shift implementation consists of an integer part and a fractional part. The integer part is realized by providing an N samples delay. The fractional part is realized by a fractional delay filter (see [Section 4.3.2](#)).

After calculating the active and reactive power, the apparent power is calculated by the formula shown in [Equation 4](#):

$$P_{APP, ph} = \sqrt{P_{ACT, ph}^2 + P_{REACT, ph}^2} \quad (4)$$

4.2.1.3 Frequency (Hz)

The background process calculates the frequency in terms of samples per Mains cycle. The foreground process then converts this to Hertz by the formula shown in [Equation 5](#):

$$\text{Frequency (Hz)} = \frac{\text{Sampling Rate (samples / second)}}{\text{Frequency (samples / cycle)}} \quad (5)$$

4.2.1.4 Power Factor

After the active power and apparent power have been calculated, the absolute value of the power factor is calculated. In the meter's internal representation of power factor, a positive power factor corresponds to a capacitive load and a negative power factor corresponds to an inductive load. The sign of the internal representation of power factor is determined by whether the current leads or lags voltage, which is determined in the background process. Therefore, the internal representation of power factor is calculated by the formula shown in [Equation 6](#):

$$\text{Internal Representation of Power Factor} = \begin{cases} \frac{P_{Act}}{P_{Apparent}}, & \text{if capacitive load} \\ -\frac{P_{Act}}{P_{Apparent}}, & \text{if inductive load} \end{cases} \quad (6)$$

4.3 Metrology Background Process

The metrology background process uses the $\Sigma\Delta$ interrupt as a trigger to collect voltage and current samples (up to three values). These samples are used to calculate intermediate results in dedicated 48-bit accumulation registers for parameters explained in [Section 4.2](#). The background function deals mainly with time critical events in software. Once sufficient samples (1 second worth) have been accumulated, the foreground process is triggered to calculate final values of V_{RMS} , I_{RMS} , active, reactive and apparent powers, active, reactive and apparent energy, frequency, and power factor. The background process is also wholly responsible for the calculation of energy proportional pulses, frequency (in samples and cycle), and the sign of the power factor.

Figure 8 shows the flow diagram of the background process.

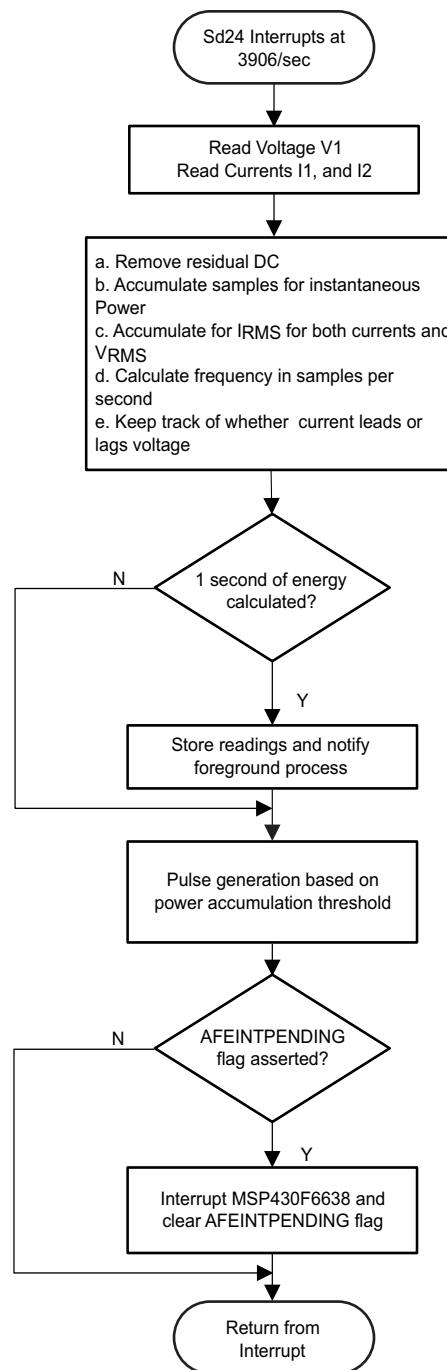

Figure 8. Background Process

The following sections discuss the various elements of electricity measurement in the background process.

4.3.1 Voltage and Current Signals

The $\Sigma\Delta$ converter has fully differential input architecture and each $\Sigma\Delta$ pin can accept negative inputs; therefore, no level-shifting is necessary for the incoming AC voltage (unlike single-ended or pseudo-differential converters).

The output of each $\Sigma\Delta$ is a signed integer and any stray DC or offset value on these $\Sigma\Delta$ s are removed using a DC tracking filter in the software. Separate DC estimates for voltage and current are obtained using the filter for voltage and current samples, respectively. This estimate is then subtracted from subsequent voltage and current samples.

The resulting instantaneous voltage and current samples are used to generate the following intermediate results:

- Accumulated squared values of voltage and current, which is used for VRMS and IRMS calculations, respectively.
- Accumulated energy samples to calculate active energy.
- Accumulated energy samples using current and 90° phase shifted voltage to calculate Reactive Energy.

These accumulated values are processed by the foreground process.

4.3.2 Phase Compensation

When a Current Transformer (CT) is used as a sensor, it introduces a phase shift between the current and voltage signals. Also, the voltage and current input circuit's passive components may introduce another phase shift. The relative phase shift between voltage and current samples need to be compensated to ensure accurate measurements. The $\Sigma\Delta$ converters have programmable delay registers (SD24PREx) that can be applied to a particular channel. This built-in feature (PRELOAD) is used to provide the phase compensation required. Figure 9 shows the usage of PRELOAD to delay sampling on a particular channel.

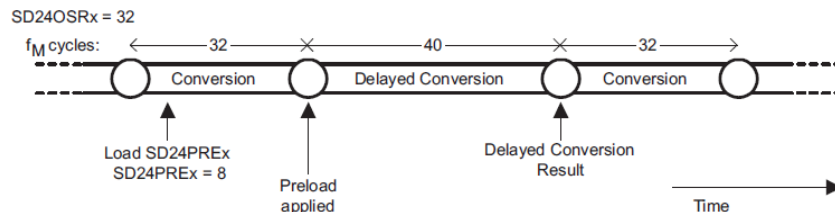

Figure 9. Phase Compensation Using PRELOAD Register

The fractional delay resolution is a function of input frequency (f_{in}), OSR and the sampling frequency (f_s).

$$Delay\ resolution_{Deg} = \frac{360^\circ \times f_{in}}{OSR \times f_s} = \frac{360^\circ \times f_{in}}{f_m} \tag{7}$$

In this application, for an input frequency of 60Hz, OSR of 256 and sampling frequency of 3906, the PRELOAD register resolution (1 step) is about 0.02° and the maximum PRELOAD delay (maximum of 255 steps) is 5.25°. When using CTs that provide a larger phase shift than this maximum, entire sample delays along with fractional delay must be provided. This phase compensation can also be modified on the fly to accommodate temperature drifts in CTs, but one must ensure that the conversions on the $\Sigma\Delta$ have been stopped.

4.3.3 Frequency Measurement and Cycle Tracking

The instantaneous current and voltage samples for each phase are accumulated in 48-bit registers. A cycle-tracking counter and sample counter keep track of the number of samples accumulated. When approximately one second's worth of samples have been accumulated, the background process stores these 48-bit registers and notifies the foreground process to produce the average results such as RMS and power values. Cycle boundaries are used to trigger the foreground averaging process since it produces very stable results.

For frequency measurements, do a straight-line interpolation between the zero crossing voltage samples. Figure 10 depicts the samples near a zero cross and the process of linear interpolation.

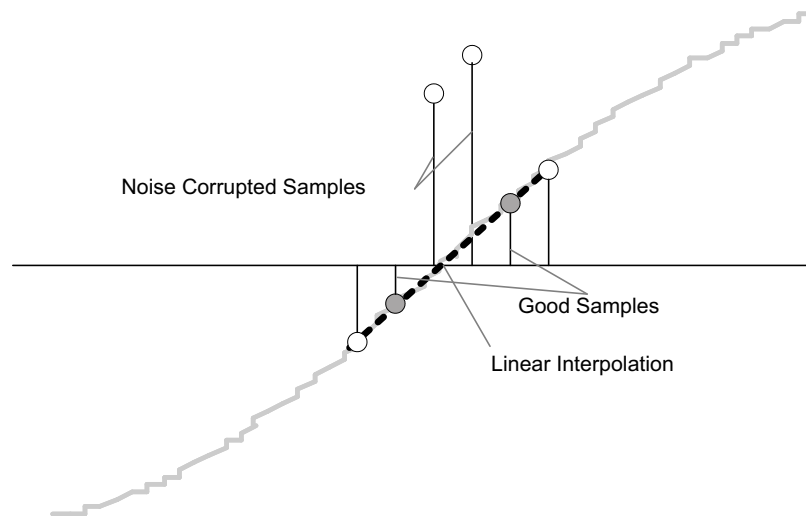

Figure 10. Frequency Measurement

Since noise spikes can cause errors, the application uses a rate of change check to filter out the possible erroneous signals and make sure points interpolated are from genuine zero-crossing points. For example, with two negative samples, a noise spike can make one of them positive, and therefore, make the negative and positive pair look as if there is a zero crossing.

The resultant cycle-to-cycle timing goes through a simple low-pass filter to further smooth out cycle-to-cycle variations. This results in a stable and accurate frequency measurement tolerant of noise.

4.3.4 LED Pulse Generation

In electricity meters, the energy consumed is normally measured in fraction of Kilo Watt Hour (KWh) pulses. This information can be used to accurately calibrate any meter or for accuracy measurement. Typically, the measuring element (MSP430) is responsible to generate pulses proportional to the energy consumed, typically defined as “pulses/kWh”. In order to serve both these tasks efficiently pulse generation has to be accurate with relatively little jitter. Although, time jitters are not an indication of bad accuracy, it would give a negative indication on the overall accuracy of the meter. Hence the jitter has to be averaged out.

This application uses average power to generate these energy pulses. The average power (calculated by the foreground process) is accumulated every $\Sigma\Delta$ interrupt, thereby spreading the accumulated energy from the previous 1 second time frame evenly for each interrupt in the current 1 second time frame. This is equivalent to converting it to energy. Once the accumulated energy crosses a threshold, a pulse is generated. The amount of energy above this threshold is kept and new energy value is added on top of it in the next interrupt cycle. Since the average power tends to be a stable value, this way of generating energy pulses are very steady and free of jitter.

The threshold determines the energy “tick” specified by meter manufacturers and is a constant. It is usually defined in “pulses/kWh” or just in KWh. One pulse is needed to be generated for every energy “tick”. For example, in this application, the number of pulses generated/KWh is set to 1600 for active and reactive energies. The energy “tick” in this case is 1KWh/1600. Energy pulses are generated and available on a header and also via LEDs on the board. General purpose I/O (Port) pins are used to produce the pulses. The number of pulses/kWh and each pulse-width can be configured in software.

Figure 11 shows the flow diagram for pulse generation.

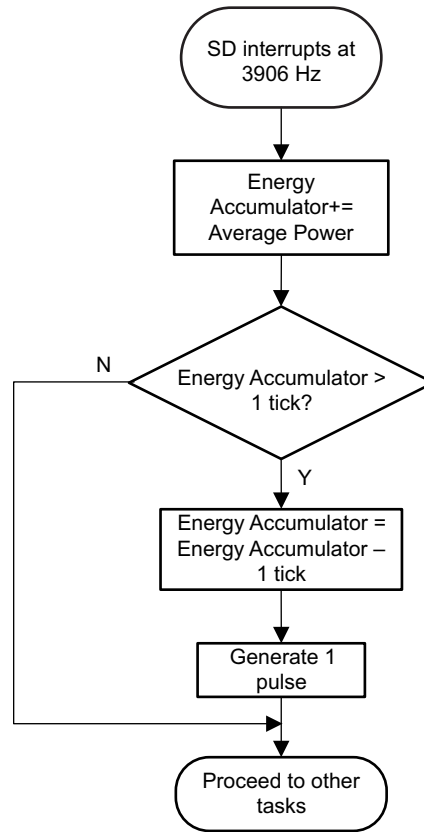

Figure 11. Pulse Generation for Energy Indication

In this application, the average power is represented in units of 0.01W; therefore, the corresponding value of the 1KWh threshold is defined as:

$$\begin{aligned}
 1\text{KWh threshold} &= 1/0.01 * 1\text{KW} * (\text{Number of interrupts/sec}) * (\text{number of seconds in 1 Hr}) \\
 &= 100000 * 3906 * 3600 = 0x14765AAD400
 \end{aligned}$$

4.4 Application Processor Software

The application processor is a proxy between the AFE and various types of external communication and LCD display. It is responsible for responding to port (I/O) and SPI (receive) interrupts from the AFE and USB interrupts from a PC GUI. Figure 12 shows the flowchart of the main components of the software that runs on the MSP430F663x.

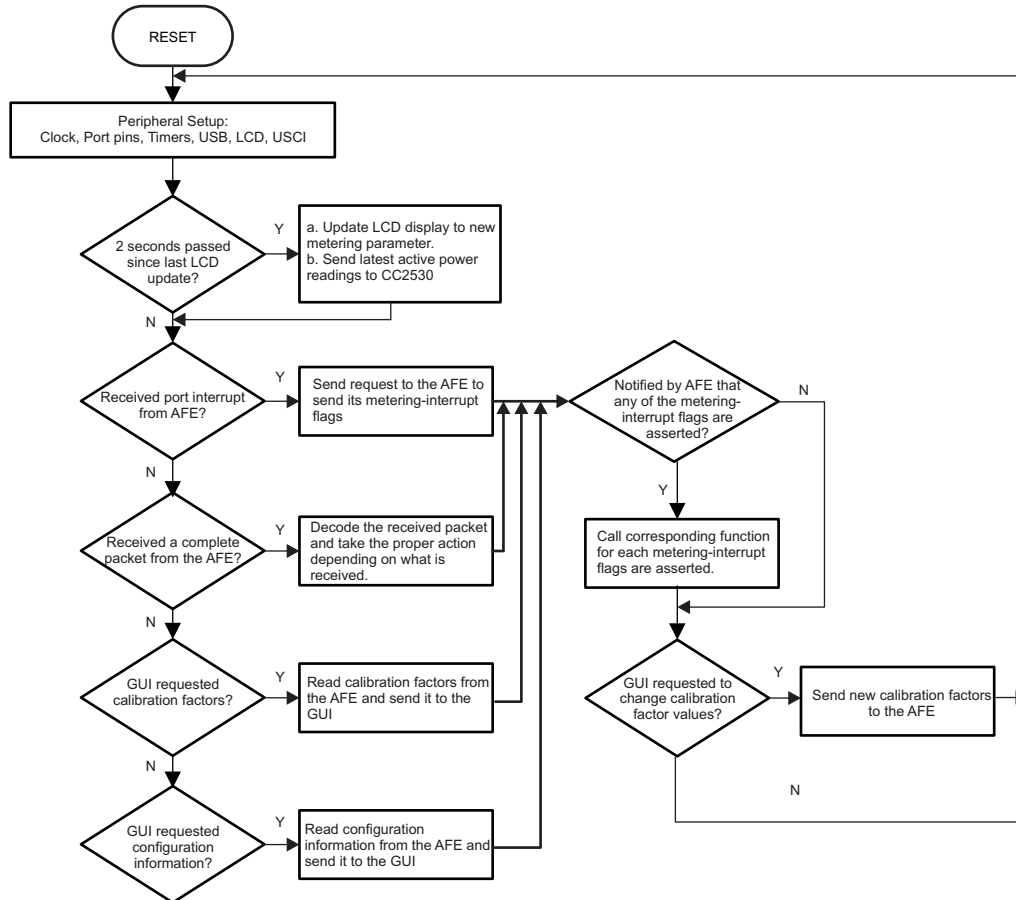

Figure 12. Application Software

After a device reset, the MSP430F663x sets up the peripherals. It initializes the CPU/ SMCLK clock (at 8 MHz), port pins, timers, USB, USCI and LCD. One USCI module is configured for SPI communication to the MSP430AFE and another module is configured for UART for wireless communication. In this application, the USCI module for SPI communication is configured as a 3-pin, 8-bit SPI master with a SPI clock of 1 MHz. The USCI module that is configured for UART communication is connected to a ZigBee network processor (CC2530), and is configured for 8N1 with a baud rate of 115200.

Once the hardware has been configured, the MSP430F663x enters a while loop. At the beginning of each iteration of the loop, a timer flag is checked to determine the start of a new 2-second interval. Every 2-second interval, the LCD display is updated with a different metering parameter. Additionally, updated active power readings received from the MSP430AFE are sent to a RF transceiver (CC2530, configured as transmitter). Section 4.5 discusses how the MSP430F663x receives the active power readings and other metering parameters from the MSP430AFE.

After determining if it is a new 2-second interval, as shown in Figure 12, appropriate actions are taken.

4.5 Transferring New E-Meter Parameters From AFE to MSP430F663x

Although the MSP430F663x calls a function for each asserted metering-interrupt flag, only one of these functions actually has code to deal with its corresponding metering-interrupt flag being asserted. This function deals with the case the AFE has just calculated new emeter-parameters and has alerted the MSP430F663x via the corresponding metering-interrupt flag. For the other functions, you can add code to customize the performed actions for each metering interrupt. Figure 13 shows the process used to calculate the metering parameters and transfer the newly calculated parameters from the AFE to the MSP430F663x.

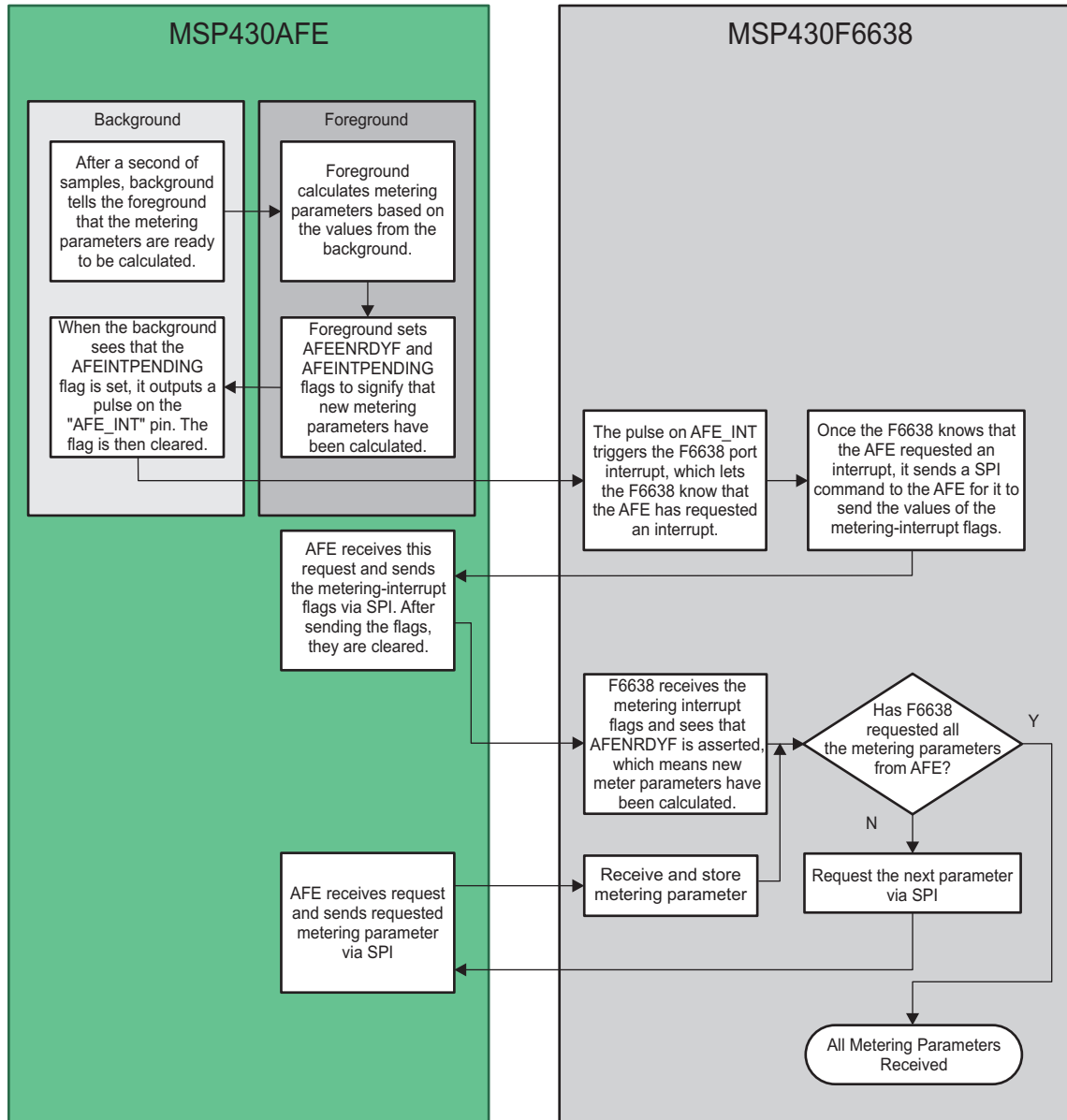

Figure 13. Transference of Meter Parameters From AFE to MSP430F663x

4.6 Energy Meter Configuration

Included files are used to initialize and configure the energy meter to perform several metrology functions. In this section, some of the available options are listed that are user configurable. The file that needs modification is the *emeter-1ph-bare-bones-afe.h* present in the parent directory *emeter-ng*. It includes the following macro definitions that are used during the normal operation of the meter:

1. **MAINS_FREQUENCY_SUPPORT**: This macro configures the meter to measure the frequency of the mains.
2. **MAINS_NOMINAL_FREQUENCY**: This macro defines the default mains frequency, which is a starting point for dynamic phase correction for non-linear CTs, or other sensors for which the phase changes with the current.
3. **TOTAL_ENERGY_PULSES_PER_KW_HOUR**: This macro defines the total number of pulses per 1KWh of energy. In this application, it is defined as 1600. It is important to note that this value is not a standard, but widely used by many meter manufacturers. There could be a practical limit set on this number due to the reference meter's ability to accept fast pulses (due to large currents).
4. **ENERGY_PULSE_DURATION**: This macro defines the duration of the LED ON time for an energy pulse. This is measured in ADC samples (increments 1/3906 s). The maximum allowed is 255, giving a pulse of about 62.5 ms and 163 gives a 40 ms pulse. This duration might be too large with adjacent pulses overlapping when very high currents are measured. It is recommended that this value be changed to a smaller number such as 80, if overlap is seen at the pulse outputs.
5. **NEUTRAL_MONITOR_SUPPORT**: This macro enables the support for neutral monitoring. The third SD24_A is used for this purpose.
6. **VRMS_SUPPORT**: This macro is used to configure the meter to calculate V_{RMS} from the voltage samples.
7. **IRMS_SUPPORT**: This macro is used to configure the meter to calculate I_{RMS} from the current samples.
8. **REACTIVE_POWER_SUPPORT**: This macro is used to configure the meter to calculate the reactive power from the voltage and current samples.
9. **REACTIVE_POWER_BY_QUADRATURE_SUPPORT**: This macro is used to configure the meter to calculate the reactive power from the 90° delayed voltage samples and current samples instead of using the power triangle method.
10. **APPARENT_POWER_SUPPORT**: This macro is used to configure the meter to calculate the apparent power.
11. **POWER_FACTOR_SUPPORT**: This macro is used to configure the meter to calculate the power factor for both lead and lag. A frequency independent method, based on the ratio of scalar dot products, is used.
12. **CURRENT_LIVE_GAIN**: This macro defines the gain of the $\Sigma\Delta$'s internal programmable gain amplifier (PGA) for the line current. In this application it is set to 1.
13. **CURRENT_NEUTRAL_GAIN**: This macro defines the gain of the SD24_A's internal PGA for neutral current monitoring. In this application it is set to 16.
14. **VOLTAGE_GAIN**: This macro defines the gain of the SD24_A's internal programmable gain amplifier (PGA) for the voltage. In this application it is set to 1.
15. **DEFAULT_V_RMS_SCALE_FACTOR_A**: This macro holds the scaling factor for voltage. This can be set to a value that is in fairly acceptable range and will be fine tuned during calibration.
16. **DEFAULT_I_RMS_SCALE_FACTOR_A**: This macro holds the scaling factor for current at live. This can be set to a value that is in fairly acceptable range and will be fine tuned during calibration.
17. **DEFAULT_P_SCALE_FACTOR_A_LOW**: This macro holds the scaling factor for active power using live current. This can be set to a value that is in fairly acceptable range and will be fine tuned during calibration.
18. **DEFAULT_BASE_PHASE_A_CORRECTION_LOW**: This macro holds the factor used for phase correction between the live channel and voltage channel. This can be set to a value that is in fairly acceptable range and will be fine tuned during calibration.

19. **DEFAULT_I_RMS_SCALE_FACTOR_NEUTRAL:** This macro holds the scaling factor for current at neutral. This can be set to a value that is in fairly acceptable range and will be fine tuned during calibration.
20. **DEFAULT_NEUTRAL_BASE_PHASE_CORRECTION:** This macro holds the factor used for phase correction between the neutral channel and voltage channel. This can be set to a value that is in fairly acceptable range and will be fine tuned during calibration.
21. **DEFAULT_P_SCALE_FACTOR_NEUTRAL:** This macro holds the scaling factor for the calculation of active power using neutral current. This can be set to a value that is in fairly acceptable range and will be fine tuned during calibration.

5 Energy Meter Demo

The energy meter evaluation module (EVM) associated with this application report has the MSP430AFE and MSP430F663x. The complete demonstration platform consists of the EVM that can be easily connected to any AC test source, metrology software, application software, and a PC GUI, which is used to view results and perform calibration.

5.1 EVM Overview

The following figures of the EVM best describe the hardware. [Figure 14](#) is the top view of the energy meter. [Figure 15](#) then shows the location of various pieces of the EVM.



Figure 14. Top View of the EVM

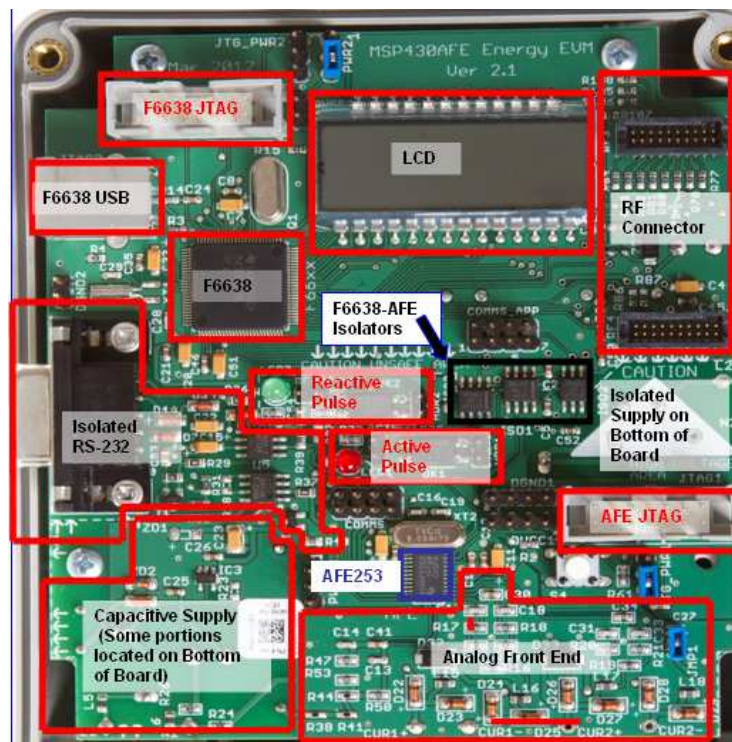

Figure 15. Top View of the EVM With Blocks and Jumpers

5.1.1 Connections to the Test Setup or AC Voltages

NOTE: This is a single-phase system and any reference to secondary currents and voltages should not be confused with a dual-phase system.

AC voltage or currents can be applied to the board for testing purposes at these points.

- Pads L1 and N1 correspond to the Line and Neutral voltage inputs. The EVM can measure up to 230 V AC, 50/60 Hz from the AC line. This line voltage can also be used to power the MSP430AFE from AC mains.
- Pads CUR1+ and CUR1-, which are the current inputs after the sensors (secondary AC current for CT or AC voltage across shunt). Care must be taken that the AC peak amplitude fed to the corresponding $\Sigma\Delta$ not exceed 500 mV.
- CUR2+ and CUR2- can also be used as current inputs to measure another current (typically used to measure return current for tamper detection). Care must be taken that the AC peak amplitude fed to the corresponding $\Sigma\Delta$ not exceed 500 mV.
- Pads L2 and N2 correspond to the same Line and Neutral voltage inputs. The AC mains Line and Neutral voltages should be connected to these pads to provide isolated power to the host MSP430F6638 and its associated components. On this EVM, this connection has not been made.

Figure 16 and Figure 17 shows the various connections that need to be made to the test set up for proper functionality of the EVM.



Figure 16. Top View of the EVM With Test Setup Connections

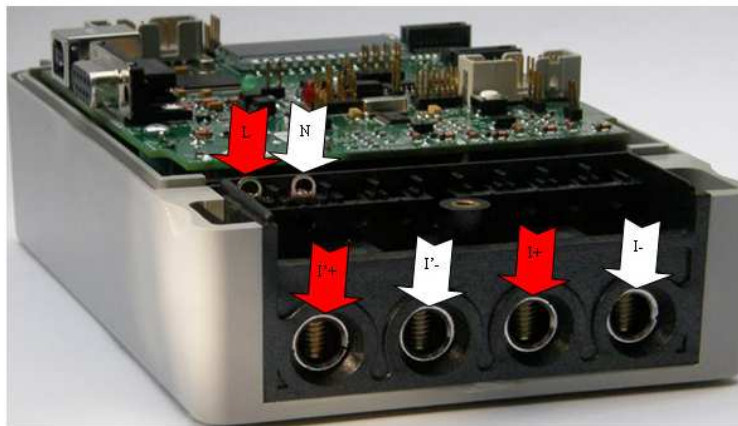

Figure 17. Side View of the EVM With Test Setup Connections

With an AC test setup, the connections have to be made according to Figure 16 and Figure 17 that show the connections from the top and side view, respectively. L and N correspond to the voltage inputs from the AC test setup. I+ and I- corresponds to one set of current inputs and I'+ and I'- corresponds to the second set of current inputs.

Although the EVM hardware and software support measurement for the second current, the EVM obtained from Texas Instruments does not have the second sensor. The current outputs from the AC test source must be connected to I+ and I- only. If an additional sensor needs to be placed, please use the two bottom left slots corresponding to terminals I'+ and I'-. Additional wired connections need to be made to connect the output of these sensors to points CUR2+ and CUR2- on the EVM.

5.1.2 Jumper Settings

This EVM provides various jumper settings and headers that can be used for debugging. [Table 1](#) shows the different header names and jumper setting on this EVM.

Table 1. Header Names and Jumper Settings on the EVM

| Name | Type | Main Functionality | Valid Use-Case | Comments |
|-----------|------------------|---|---|---|
| ACT | 2-pin header | Active Energy Pulses + GND (WARNING) | Probe here for active energy pulses. The pin under the "ACT" label corresponds to the Active Energy Pulse and the other pin corresponds to ground. | This header is not isolated from AC voltage so do not connect measuring equipments unless isolators external to the EVM are available. See HDR1 instead. |
| COMMS | 4 x 2-pin header | Communication header for MSP430AFE (WARNING) | This contains the SPI and UART lines of the MSP430AFE isolated from the MSP430F6638. This header also contains the non-isolated active and reactive energy pulse outputs (Duplicated on ACT and REACT headers). | The SPI pins on this header are interfaced to the MSP430F663x via on board isolators (ISO1/ISO2/ISO3). The UART pins correspond to the UART signals and are not the associated translated RS-232 signals; therefore, they have UART voltage levels and not RS232 voltage levels. Do not connect the active and reactive pulse pins on this header to a scope or other measuring equipment if external isolators are not present. See HDR1 and HDR2 instead. |
| COMMS_APP | 4 x 2-pin header | Communication header for MSP430F663x | This contains the SPI lines and the application interrupt pin (APP_INT) and other signals connected to the RF connector: RF_GPIO1, RF_GPIO2, and SFD. | The SPI pins on this header are interfaced to the MSP430AFE via on board isolators (ISO1/ISO2/ISO3). The APP_INT is an isolated input from the MSP430AFE used to alert the MSP430F6638 that updated metering parameters are ready. All pins on this header are isolated from the AC mains |
| DGND1 | Header | Ground voltage header for MSP430AFE (WARNING) | Probe here for GND voltage of the MSP430AFE (DGND_AFE). Connect negative terminal of bench or external power supply when powering the MSP430AFE externally. | Do not probe here if the MSP430AFE is connected to AC mains unless when using an isolated AC test setup. |
| DGND2 | Header | Ground Voltage Header for MSP430F663x | Probe here for GND voltage of the MSP430F663x (DGND_APP). Connect negative terminal of bench or external power supply when powering the MSP430F663x externally. | Note that DGND_APP is not isolated with USB GND voltages on the EVM. |
| DVCC1 | Header | VCC Voltage Header for MSP430AFE (WARNING) | Probe here for VCC supply voltage of the MSP430AFE (DVCC_AFE). Connect positive terminal of bench or external power supply when powering the MSP430AFE externally. | Do not probe here if the MSP430AFE is connected to AC mains unless when using an isolated AC test setup. |
| DVCC2 | Header | VCC Voltage Header for MSP430F663x (WARNING) | Probe here for VCC supply voltage of the MSP430F663x (DVCC_APP). Connect positive terminal of bench or external power supply when powering the MSP430F663x externally. | Note that DGND_APP is not isolated with USB GND voltages on the EVM. |
| HDR1 | Header | Isolated Active Energy Pulses | Probe here for isolated active energy pulses. | This is isolated from AC mains voltage so it is safe to connect a scope or other measuring equipments since isolators are already present on the EVM. |
| HDR2 | Header | Isolated Reactive Energy Pulses | Probe here for reactive energy pulses | This is isolated from AC mains voltage so it is safe to connect a scope or other measuring equipments since isolators are already present on the EVM. |
| JMP1 | Jumper | "CUR2" Current Sensor Reference | Place a jumper here to reference the negative terminal of the "CUR2" $\Sigma\Delta$ to Analog ground (AGND_AFE). | Conditions based on Sensor: CT: Always have a jumper Shunt: Do not connect a jumper |
| JTG_PWR1 | Jumper | JTAG Power Selection for MSP430AFE | Jumper placed during JTAG programming. | See the next section for configuration information. |

Table 1. Header Names and Jumper Settings on the EVM (continued)

| Name | Type | Main Functionality | Valid Use-Case | Comments |
|----------|--------|--|---|--|
| JTG_PWR2 | Jumper | JTAG Power Selection for MSP430F663x | Jumper placed during JTAG programming. | See the next section for configuration information. |
| PWR1 | Jumper | Power Option Select for MSP430AFE | Jumper placed when powering the MSP430AFE either via AC Mains or external power. | See the next section for configuration information. |
| PWR2 | Jumper | Power Option Select for MSP430F663x | Jumper placed when powering the MSP430F663x either via Mains or external power. | See the next section for configuration information. |
| REACT | Header | Reactive Energy Pulses + GND (WARNING) | Probe here for reactive energy pulses. The pin next to the LED corresponds to the Reactive Energy Pulse pin and the other pin corresponds to ground | This header is not isolated from AC voltage so do not connect measuring equipments unless isolators external to the EVM are available. See HDR2 instead. |

5.1.3 Power Supply Options

The EVM can be configured to operate with different sources for power specific to the MSP430AFE and the MSP430F663x. The various sources of power to the MSP430s are JTAG, AC mains voltage, and external bench supply and battery. [Table 2](#) lists the header settings for the power options of the MSP430AFE only.

Table 2. Power Supply Selection for MSP430AFE

| Power Option | JTG_PWR1 | PWR1 |
|-----------------------------------|---|-----------------|
| JTAG | Jumper on bottom two pins when board is oriented as in Figure 12 | No jumper |
| AC Mains Voltage (WARNING) | No jumper if debugging is not desired; Do not debug using JTAG unless AC source or JTAG is isolated from each other. Jumper on the top two pins (when the board is oriented, as shown in Figure 12) if debugging is desired. | Jumper on [1-2] |
| External bench supply and battery | No jumper if debugging is not desired. Jumper on the top two pins (when the board is oriented, as shown in Figure 12) if debugging is desired. | Jumper on [2-3] |

When powered by the mains supply, PWR2 header can also be treated as a current consumption header by placing an ammeter across it.

5.2 Loading the Example Code

The source code is developed in the IAR environment using IAR version 5.x for the MSP430 integrated development environment (IDE) and version 6.x compiler version 6.x for the IAR Embedded Workbench® common components. If earlier versions of IAR are used, the project files will not open. If later than 6.x versions are used when project is loaded, a prompt to create a back-up will be issued; click **YES** to proceed. There are two sets of code: the energy metrology software that runs on the MSP430AFE and the application code that runs on the MSP430F663x. The energy metrology software consists of two parts: the toolkit that contains a library of mostly math routines and the main code that has the source and include files.

5.2.1 Opening the Project

Use the software provided as an associated zip file with this application report, which can be downloaded from the following URL: <http://www.ti.com/lit/zip/slaa632>.

The “source” folder structure is shown in Figure 18.

| Name | Size | Type | Date Modified |
|--------------|------|-------------|--------------------|
| F6638Host | | File Folder | 10/30/2012 8:54 AM |
| GUI | | File Folder | 2/24/2012 8:48 AM |
| AFEmetrology | | File Folder | 1/19/2013 9:30 PM |

Figure 18. Source Folder Contents

The F6638Host folder contains project files for the application software that is executed on the MSP430F663x. For this application, use the *MSP430F6638_Interface.ewp* project file. The *AFEmetrology* folder contains project files for the metrology software and necessary toolkit library that is executed on the MSP430AFE. The toolkit project is called *emeter_toolkit_AFE.ewp* and is located in the *emeter-toolkit* folder, which is in the *AFEmetrology* folder. For the metrology software, use the *AFE253_Interface.ewp* project file, which is in the *emeter-ng* folder that is in the *AFEmetrology* folder. For first time use, it is recommended that all three projects get completely rebuilt:

1. Open the *IAR Embedded Workbench*, find and load the *emeter_toolkit_AFE.ewp* project, and *Rebuild All*, as shown in Figure 19.

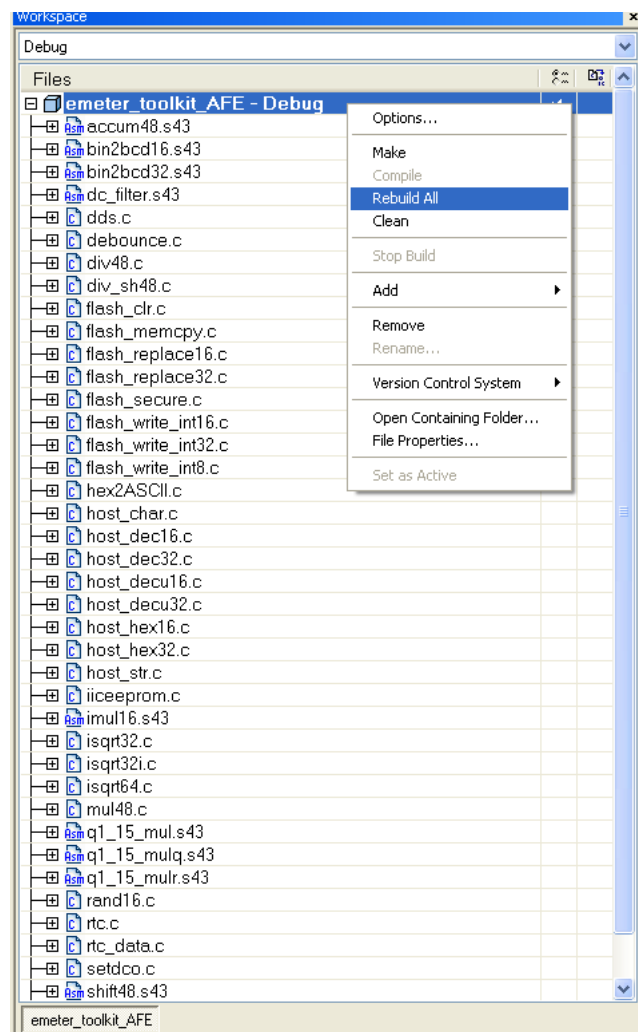

Figure 19. Toolkit Compilation in IAR

2. Close the existing workspace, open the main project *MSP430F6638_Interface.ewp*, and *Rebuild All*, as shown in [Figure 20](#).

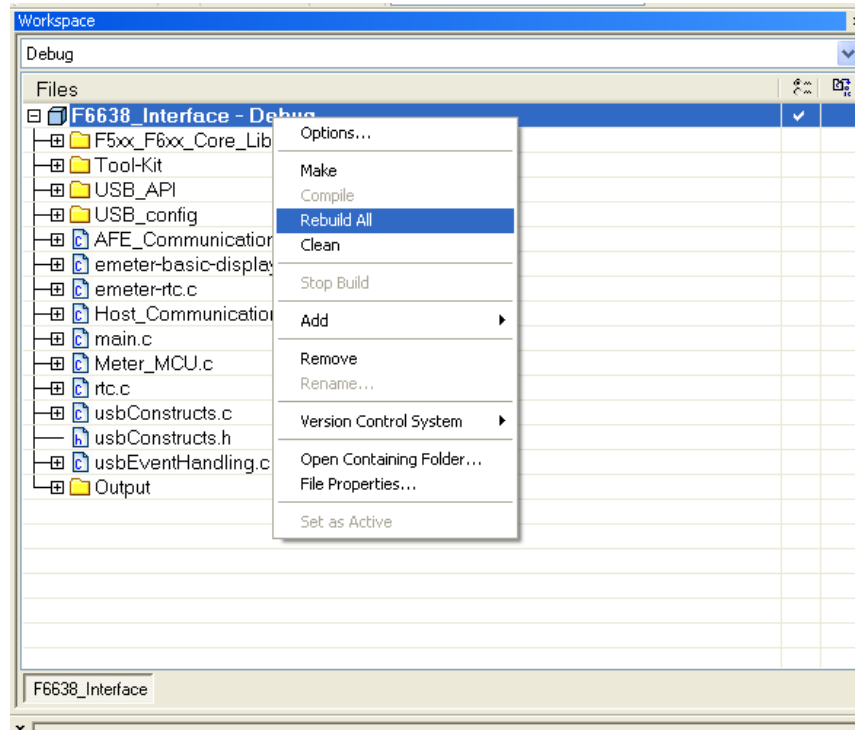

Figure 20. Application Compilation in IAR

3. Once the *F6638_Interface* project that has been rebuilt, download it onto the *MSP430F663x* by connecting the FET tool to *JTAG2*, clicking *Download and Debug*, and then pressing *Go* from the *Debug* menu.
4. Exit the Debugger and close the existing workspace.
5. Open the main project *AFE253_Interface.ewp* and *Rebuild All*, as shown in [Figure 21](#).
6. Once the *AFE253_Interface* project has been rebuilt, download it onto the *MSP430AFE* by connecting the FET tool to *JTAG1*, clicking *Download and Debug*, and then pressing *Go* from the *Debug* menu.
7. Exit the Debugger and close the existing workspace.

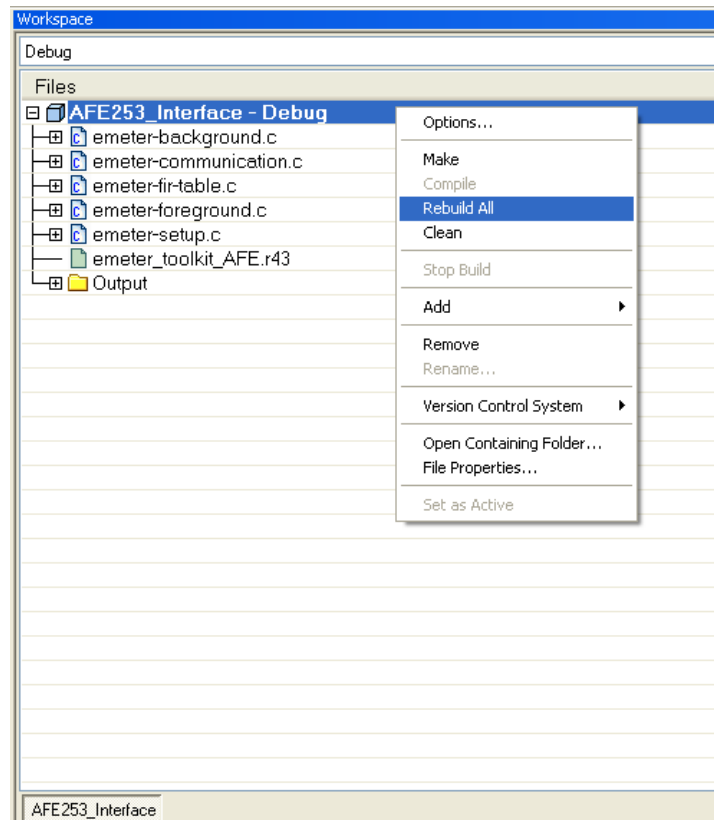

Figure 21. Metrology Compilation in IAR

6 Results and Calibration













When the MSP430F6638 and MSP430AFE are turned ON, the results will be available via LCD, and the PC GUI.

6.1 Viewing Results via LCD

Table 3 shows the different metering parameters that are displayed on the LCD. If the AFE is not turned ON, then the metering parameters (with the exception of day and time) will not be updated from their respective initial values. The initial values for the metering parameters are shown in the *Initial LCD Value* column of Table 3. The LCD display scrolls between metering parameter every 2 seconds. To distinguish metering parameters from each other, one or two characters are displayed on the LCD to the left of the actual reading. The *Symbol* column in Table 3 shows which characters correspond to which metering parameter.

The *Comments* column of Table 3 provides a brief interpretation of the displayed metering parameters.

Table 3. Description of LCD-Displayed Parameters

| Parameter Name | Symbol | Units | Initial LCD Value | Comments |
|------------------------------|---|------------------------------|-------------------|---|
| Voltage |  | Volts (V) | 0.08 | — |
| Current |  | Amps (A) | 0.009 | “.” symbol represents the decimal point “.” |
| Frequency |  | Hertz (Hz) | 0.00 | — |
| Active Power |  | Watt (W) | 0.0 | — |
| Total consumed Active Energy |  | 100 “Tick” | 0.0 | Every 10 ticks increments the tenths place by 1. |
| Date |  | Year/Month/ Day (yymmdd) | 110321 | — |
| Time |  | Hour/Minute/ Second (hhmmss) | 010203 | — |
| Reactive Power |  | Volt-Ampere Reactive (var) | 0.0 | — |
| Apparent Power |  | Volt-Ampere (VA) | 0.0 | — |
| Power Factor | FC/FL | Constant between 0 and 1 | 0.00 | <p> The characters  are used if the load is determined to be a capacitive load.</p> <p> The characters  are used if the load is determined to be an inductive load.</p> |

6.2 Viewing Results Using RF technology (ZigBee)

The CC2530 evaluation module is an add-on and plug-in daughter card for ZigBee/IEEE 802.5.4 RF application in the 2.4 GHz unlicensed ISM band. The communication interface to any host and application processor is via UART. The instantaneous power consumption is sent periodically to the ZigBee module for wireless transmission.

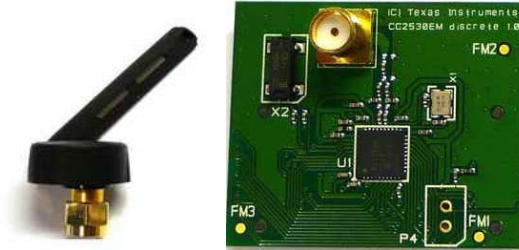

Figure 22. ZigBee Radio

This ZigBee module is connected via the UART, which is configured to 115.2 kbaud to the MSP430F6638 on the transmit portion and the MSP430F4618 on the receive portion (IHD430).

6.3 In-Home Display (IHD)

Most IHDs have their own setup mechanism and all of them tend to join the ZigBee network once turned ON. In this section, it is assumed that TI's "IHD430" is used as the in-home display (<http://www.ti.com/tool/TIDM-LOWEND-IHD>). The IHD430 has a MSP430F461x as an application and host processor.



Figure 23. TI Designed IHD430

6.3.1 Viewing Active Power Readings on the IHD430

Place a CC2530 module in the RF connector socket of the meter (EVM430-AFE253), making sure that it is properly oriented. This CC2530 should be flashed with code to act as a transmitter. The IHD430 also has a corresponding CC2530 flashed to act as a receiver.

6.3.2 Initializing the IHD430

Power must be provided by two AAA batteries, or an external supply. The power source is selected by configuring jumpers on V_{CC} and BATT headers and the power is supplied to the on-board MSP430 by placing a jumper on PWR1 header. The power setup options are provided in the following bullet points:

- Jumper settings to provide Battery power are:
 - Place Jumper on BATT header
 - Place Jumper on PWR1 header
- Jumper settings to provide Flash emulation tool power are:
 - Place Jumper on pins [1-2] on VCC 3-pin header
 - Place Jumper on PWR1 header
- Jumper settings to provide External power are:
 - Place Jumper on pins [2-3] on VCC 3-pin header
 - Place Jumper on PWR1 header
- Ensure jumper is placed on RF_PWR header, which has been provided to enable and disable power to CC2530.

The MSP430F663x software is automatically configured to communicate the active power readings to the on-board CC2530 transmitter via 8N1 UART communication at a baud rate of 115.2k. The transmitter (meter) must be turned ON before the receiver to ensure proper ZigBee communication. IHD430 receives the active power readings and displays it on the LCD. In addition, modifications can be made to MSP430F6638 software to send different parameters for display onto the IHD430.

6.4 Calibrating and Viewing Results via PC

6.4.1 Installation and Execution

6.4.1.1 Driver Installation

1. Program the MSP430F663x.
2. Connect the USB cable to the USB connector on the EVM.
3. Follow the directions when the Hardware Wizard (see [Figure 24](#)) launches.



Figure 24. Driver Installation Step 3

4. Select the *No, not this time* option and click *Next*. The screen shown in [Figure 25](#) should appear.

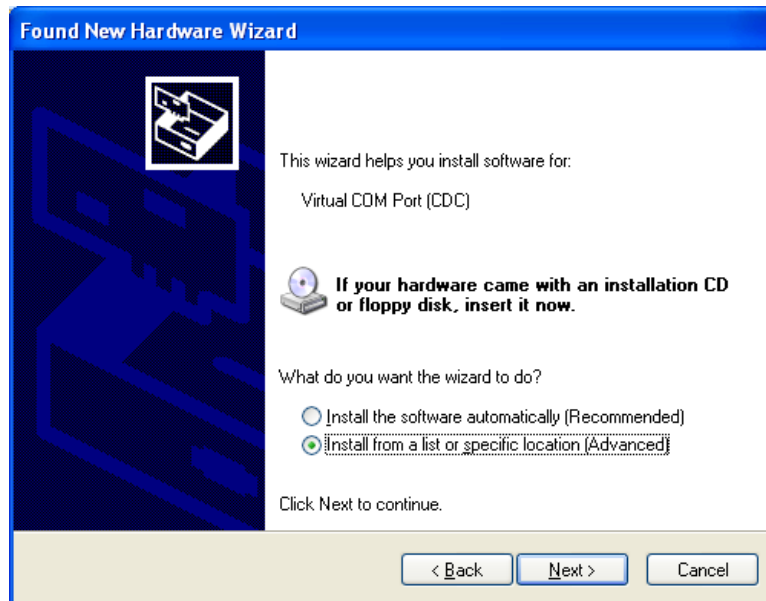

Figure 25. Driver Installation Step 4

5. Select the *Install from a list or specific location (Advanced)* option and click *Next*. The screen shown in [Figure 26](#) should appear.

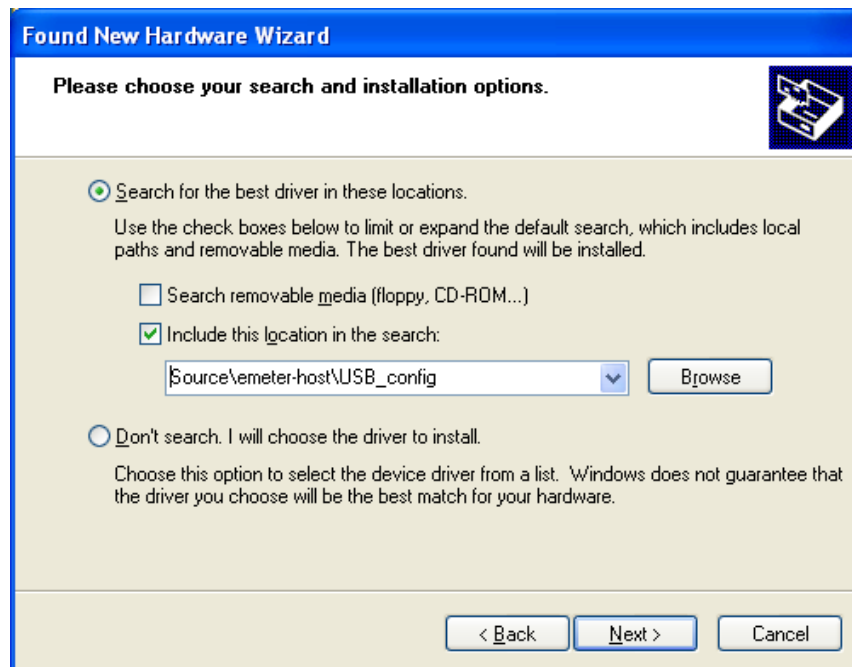

Figure 26. Driver Installation Step 5

6. Select the *Search for the best driver in these locations.* option and check the *Include this location in the search:* check box. For the file browser field, select the *USB_config* folder, which should be within the *emeter-host* folder. Then, click *Next*.

- If the screen shown in Figure 27 appears, select *Continue Anyway*.



Figure 27. Hardware Installation Prompt

- Click *Finish*.
- If the driver is installed properly, the device would be assigned a COM port in the device manager window, as shown in the Figure 28. The device should be displayed on the device manager as *Virtual Com Port (CDC)*. In this example, the EVM gets assigned COM19.

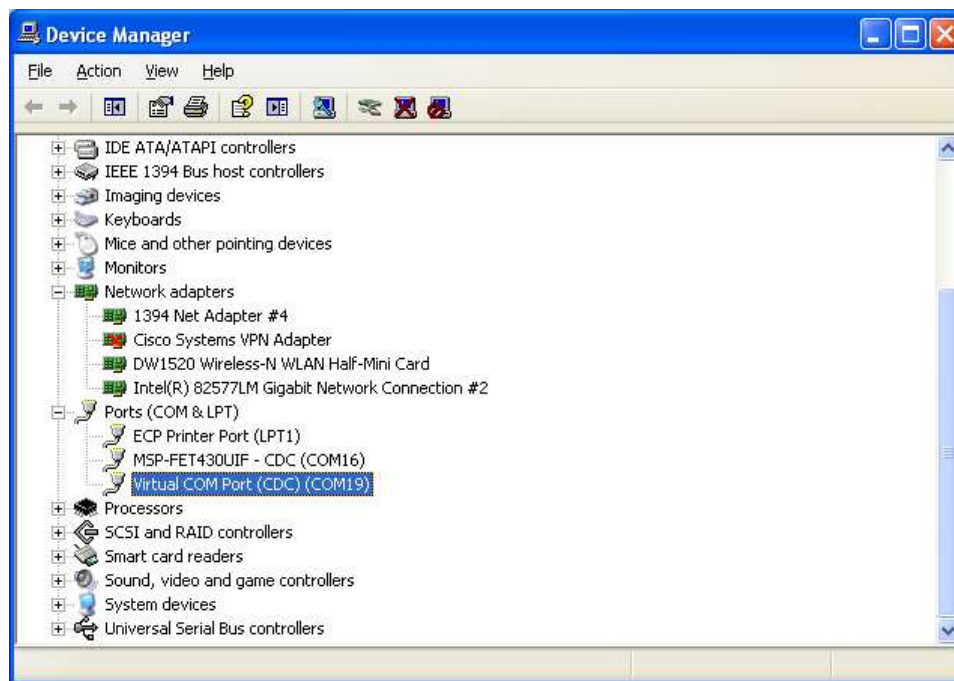
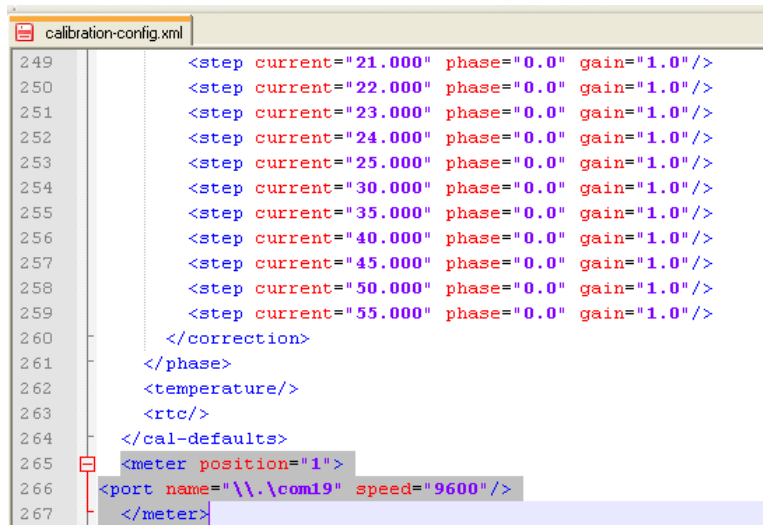

Figure 28. Device Manager With EVM Enumerated as COM19

6.4.1.2 GUI Execution

1. Open the device manager to find the COM port assigned to the EVM, once the MSP430F663x is turned on and the EVM's USB connector is connected to the PC. In this example, COM19 is used.
2. Enter the `/Source/GUI` folder and open `calibration-config.xml` in a text editor.
3. Change the `port name` field within the `meter` tag to the COM port of the meter. In [Figure 29](#), this field is changed to COM19.



```

249 <step current="21.000" phase="0.0" gain="1.0"/>
250 <step current="22.000" phase="0.0" gain="1.0"/>
251 <step current="23.000" phase="0.0" gain="1.0"/>
252 <step current="24.000" phase="0.0" gain="1.0"/>
253 <step current="25.000" phase="0.0" gain="1.0"/>
254 <step current="30.000" phase="0.0" gain="1.0"/>
255 <step current="35.000" phase="0.0" gain="1.0"/>
256 <step current="40.000" phase="0.0" gain="1.0"/>
257 <step current="45.000" phase="0.0" gain="1.0"/>
258 <step current="50.000" phase="0.0" gain="1.0"/>
259 <step current="55.000" phase="0.0" gain="1.0"/>
260 </correction>
261 </phase>
262 <temperature/>
263 <rtc/>
264 </cal-defaults>
265 <meter position="1">
266 <port name="\\.\com19" speed="9600"/>
267 </meter>

```

Figure 29. GUI Config File Changed With to EVM COM Port

4. Open the `calibrator.exe`, which is located in the `/Source/GUI` folder. If the COM port in `calibration-config.xml` was changed in the previous step to the com port of the enumerated EVM, the GUI should pop up.

Under correct connections, a top left button will be green. If there are problems with connections or if the code is not configured correctly, the button will be RED. Once the GUI is executing, the results can be viewed by pressing the green button, as shown in [Figure 30](#).

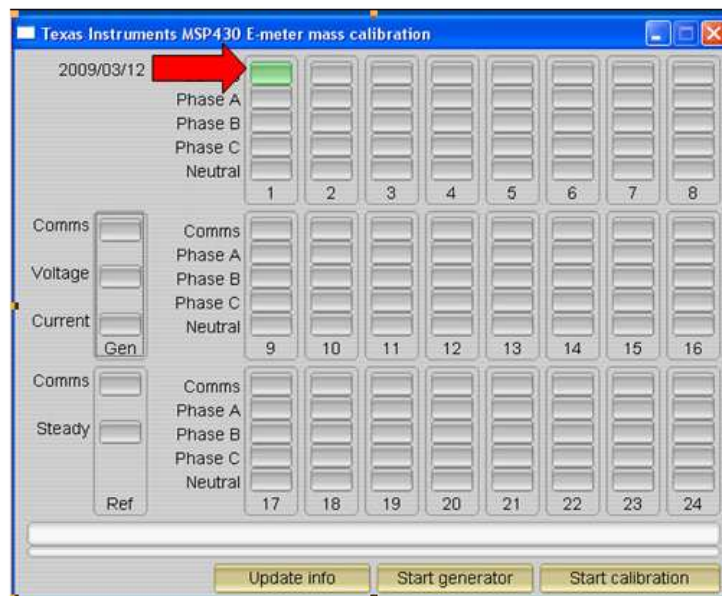

Figure 30. GUI Startup Window

6.4.2 Viewing Results

Once you click on the green button, the results window should pop up, as shown in Figure 31. Note that, unlike the LCD, the GUI power factor is displayed as a constant from 0 to 10 instead of a constant from 0 to 1. Also, there is a trailing “L” or “C” to indicate an inductive or capacitive load, respectively.



Figure 31. Results Window

6.4.3 Calibration

Calibration is key to any meter’s performance and is absolutely necessary for every meter to go through this process. Initially, every meter would exhibit different accuracies due to silicon-silicon differences, sensor accuracies and other passive tolerances. In order to nullify their effects, every meter must be calibrated. For calibration to be performed accurately there should be an accurate AC test source and a reference meter available. The source should be able to generate any desired voltage, current and phase shifts (between V and I). To calculate errors in measurement the reference meter acts as an interface between the source and the meter being calibrated. This section discusses a simple and effective method of calibration of this 1-phase EVM.

The GUI used for viewing results can easily be used to calibrate the EVM. During calibration, parameters called calibration factors are modified in the software to give least error in measurement. For this meter, there are four main calibration factors: voltage scaling factor, current scaling factor, power scaling factor, and the phase compensation factor. The voltage, current, and power scaling factors translate measured quantities in metrology software to real-world values represented in volts, current and watts respectively. The phase compensation factor is used to compensate any phase shifts introduced by the current sensors and other passives.

When the meter software is flashed with the code (available for download from <http://www.ti.com/lit/zip/slaa632>), default calibration factors are loaded into these calibration factors. For the macro definitions, see items 15- 21 in Section 4.6. These values will be modified via the GUI during calibration. The calibration factors are stored in INFO_MEM and, therefore, would remain the same if the meter is restarted. However, if code is re-flashed during debug, the calibration factors are replaced and the meter has to be re-calibrated. One way to save the calibration values is by clicking on the *Meter calibration factors* button shown in Figure 31. The meter calibration factors window displays the latest values and this could be used to directly replace the macro definition of these factors in the source code.

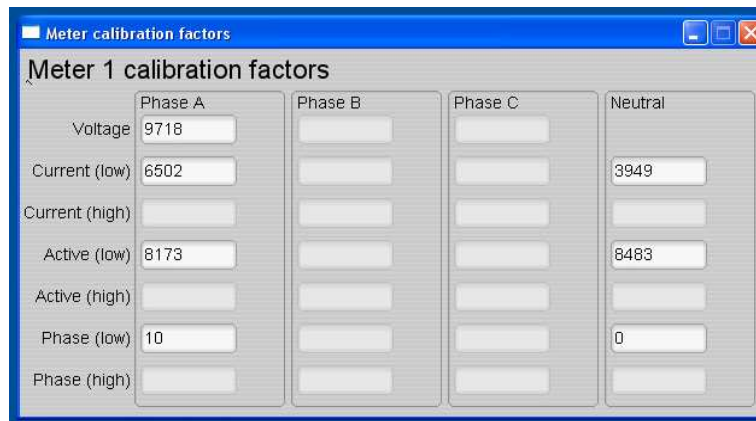

Figure 32. Calibration Factors Window

Calibrating any of the three scaling factors is referred to as gain correction. Calibrating the phase compensation factor is referred to as phase correction. For the entire calibration process, the AC test source must be ON, meter connections consistent with [Section 5.1.1](#) and the energy pulses connected to the reference meter.

6.4.3.1 Gain Calibration

Usually gain correction for voltage and current can be done simultaneously. Energy accuracy is needed for Gain correction for active power.

6.4.3.1.1 Voltage and Current Gain Calibration

To calibrate the voltage and current readings, the following steps are followed:

1. Connect the GUI to view results for voltage, current, active power, and the other metering parameters, as shown in [Figure 33](#).
2. Configure the test source to supply desired voltage and current. Ensure that these are the voltage and current calibration points with a 0° phase shift between voltage and current. For example, 230 V, 10A, 0° (PF = 1).
3. Click on the *Manual cal.* button shown in [Figure 31](#). The following screen should pop up:

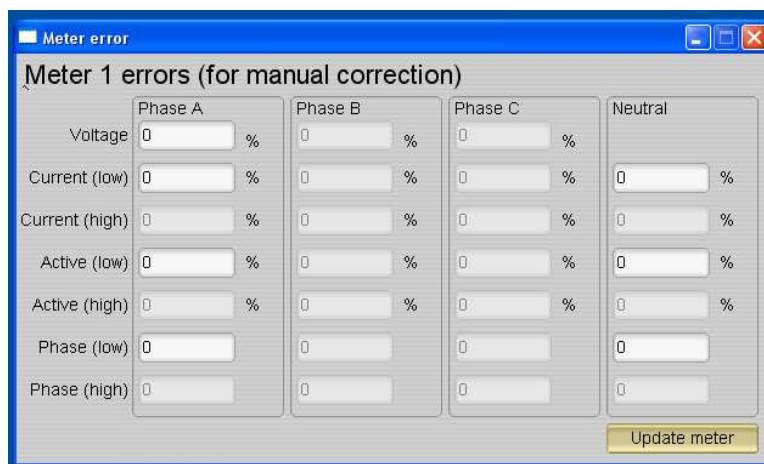

Figure 33. Manual Calibration Window

- The correction values that need to be entered for voltage and current fields are calculated by:

$$\text{Correction (\%)} = \left(\frac{\text{value}_{\text{observed}}}{\text{value}_{\text{desired}}} - 1 \right) * 100 \quad (8)$$

Where, $\text{value}_{\text{observed}}$ is the value measured by the meter and $\text{value}_{\text{desired}}$ is the calibration points configured in the AC test source.

- After calculating *Correction (%)* for voltage and current, input these values as is (\pm) for the fields *Voltage* and *Current (low)*, respectively, under *Phase A* in the GUI window.
- Click on *Update meter* and the observed values for voltage and current on the GUI would settle immediately to the desired voltage and current.

6.4.3.1.2 Active Power Gain Calibration

After performing gain correction for voltage and current, gain correction for active power must be done. Gain correction for active power is done differently in comparison to voltage and current. Although, conceptually, calculating *Correction (%)* using Step 4 with Active power readings (displayed on the AC test source) can be done, it will not be the most accurate method and should be avoided.

The best option is to get the *Correction (%)* directly from the reference meter's measurement error of the active power. This error is obtained by feeding energy pulses to the reference meter.

To perform gain correction for active power, the following steps are followed:

- It is assumed the AC test source is still ON and not reconfigured, otherwise repeat Step 1 through 3 from Section 6.4.3.1.1 with the identical voltage, current and 0° phase shift.
- Connect the meter's energy pulse output to the reference meter. Configure the reference meter to measure the active power error based on these pulse inputs.
- The reference meter should provide the % error in measurement. Note that this value may be negative.
- The error obtained in the above step is already the *Correction (%)* and this number must be entered into the *Active (low)* field under *Phase A* in the GUI window.
- Click on *Update meter* and the error values on the reference meter would immediately settle to a value close to zero.

6.4.3.2 Phase Correction

After performing power gain correction, phase calibration must be performed. The following steps are followed:

- It is assumed the AC test source is still ON and the connections are similar to what is done for gain correction. With the same voltage and current used for gain corrections, modify only the phase-shift to a non-zero value, typically, +60° is chosen.
- The reference meter displays a different % error for active power measurement. Note that this value may be negative.
- If this error is not close to zero, or unacceptable, phase calibration must be performed.
- For a phase shift greater than 0 (for example, +60°), a positive (negative) error would require a positive (negative) number as correction.
- Usually, a small \pm integer should be entered to bring the error closer to zero. Enter this value as an update for *Phase (Low)* field under the *Phase A* in the GUI window.
- Click on *Update meter* and monitor the error values on the reference meter.
- If this measurement error (%) is not accurate enough, fine tune it by incrementing and decrementing it by a value of 1 based on Step 5. Note that after a point, the fine-tuning will only result in the error oscillating on either side of zero. The value that has the smallest absolute error must be selected. After completion of this step, the calibration is complete.
- Change the phase now to -60° and check whether or not this error is still acceptable. Ideally, errors should be symmetric for same phase shift on lag and lead conditions.

After performing phase correction, calibration is complete. The new calibration factors can be viewed by clicking the *Meter Calibration factors* button of the GUI metering results window in Figure 31.

7 Read This

- This document is preliminary and is subject to change when the next board revision is made available.
- Never use the mains at the same time as debug unless you are using isolated USB FETs.
- The MSP430AFE and the MSP430F663x have two different GND planes and this needs to be maintained if PC communication is done via USB.
- The first revision of the software does not include the MSP430F663x application project that is currently in this software revision.
- Two LEDs on the board: one for Active and the other for Reactive are present to test the accuracy of the meter via Pulse generation.
- The same pulses are also available on headers ACT_PUL and REACT_PUL. However, these pulses on the header are not isolated. For isolated pulses use the header HDR1 and HDR2 instead.
- For more information and results regarding the EVM, see *Energy Measurement Results for CTs and Shunts on a TI Designed Meter Using MSP430AFE2xx Devices* ([SLAA536](#)).

8 Schematics

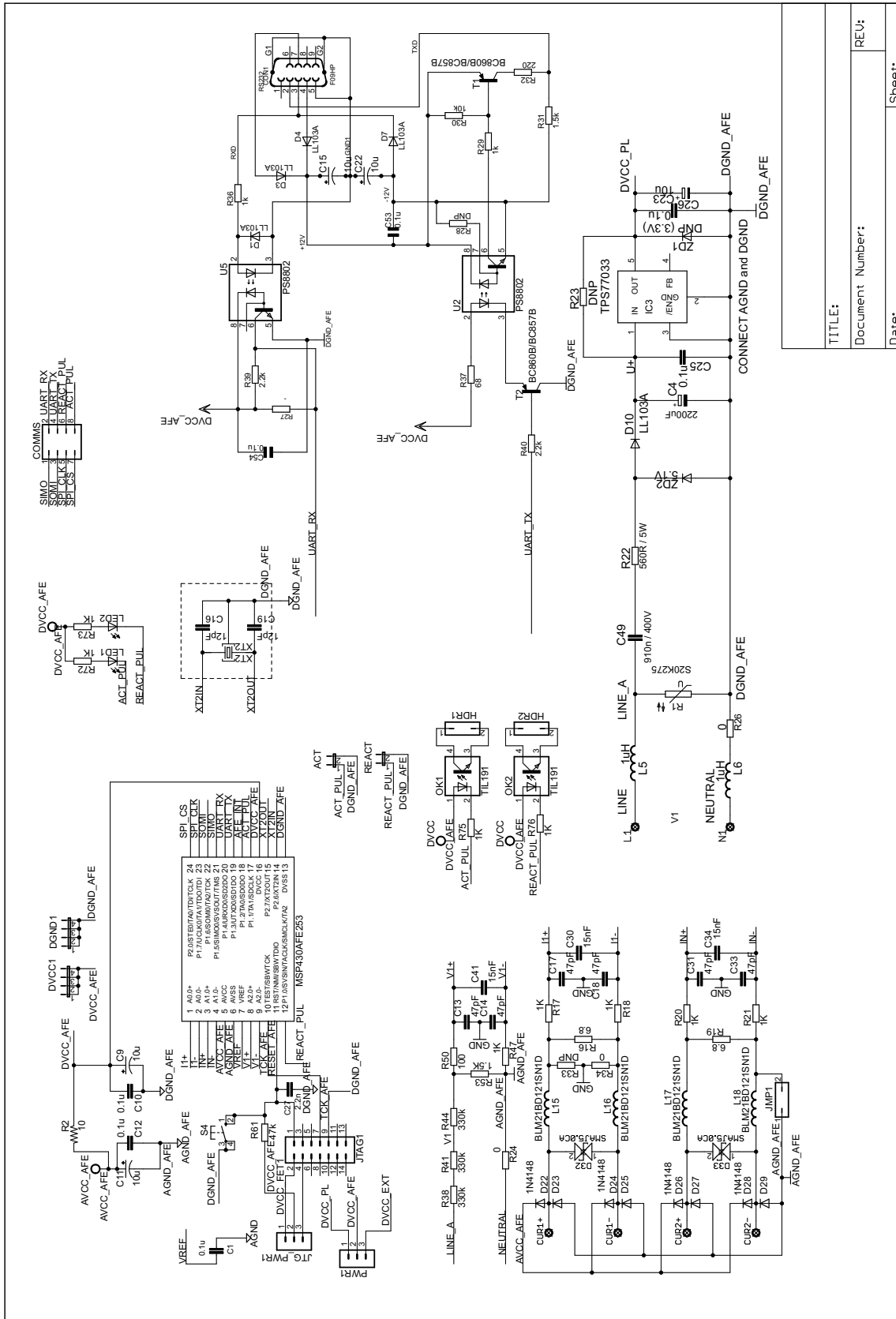

| | |
|------------------|--|
| TITLE: | |
| Document Number: | |
| Date: | |
| Sheet: | |

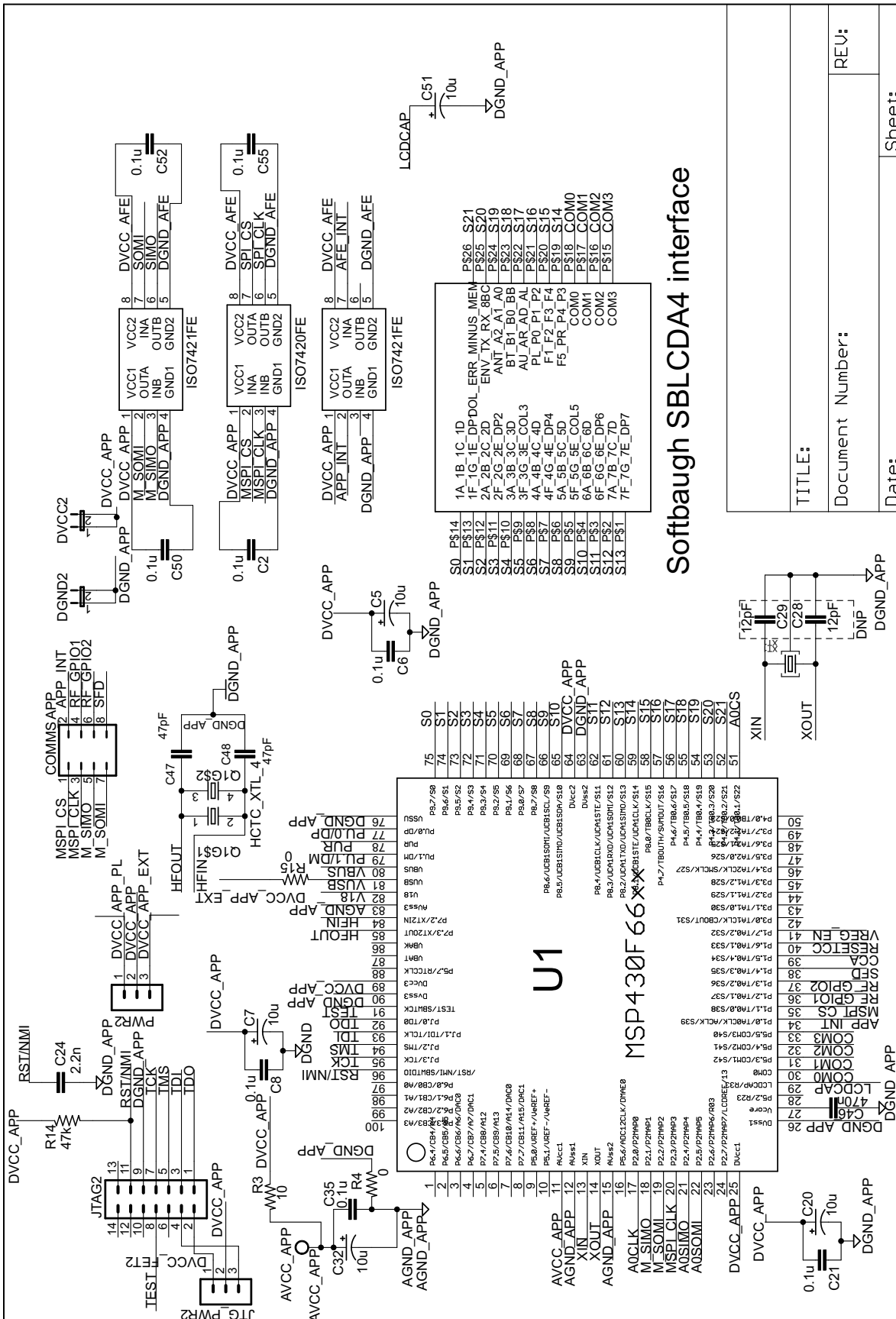

Softbaugh SBLCDA4 interface

| | |
|------------------|--------|
| TITLE: | REV: |
| Document Number: | Sheet: |
| Date: | |

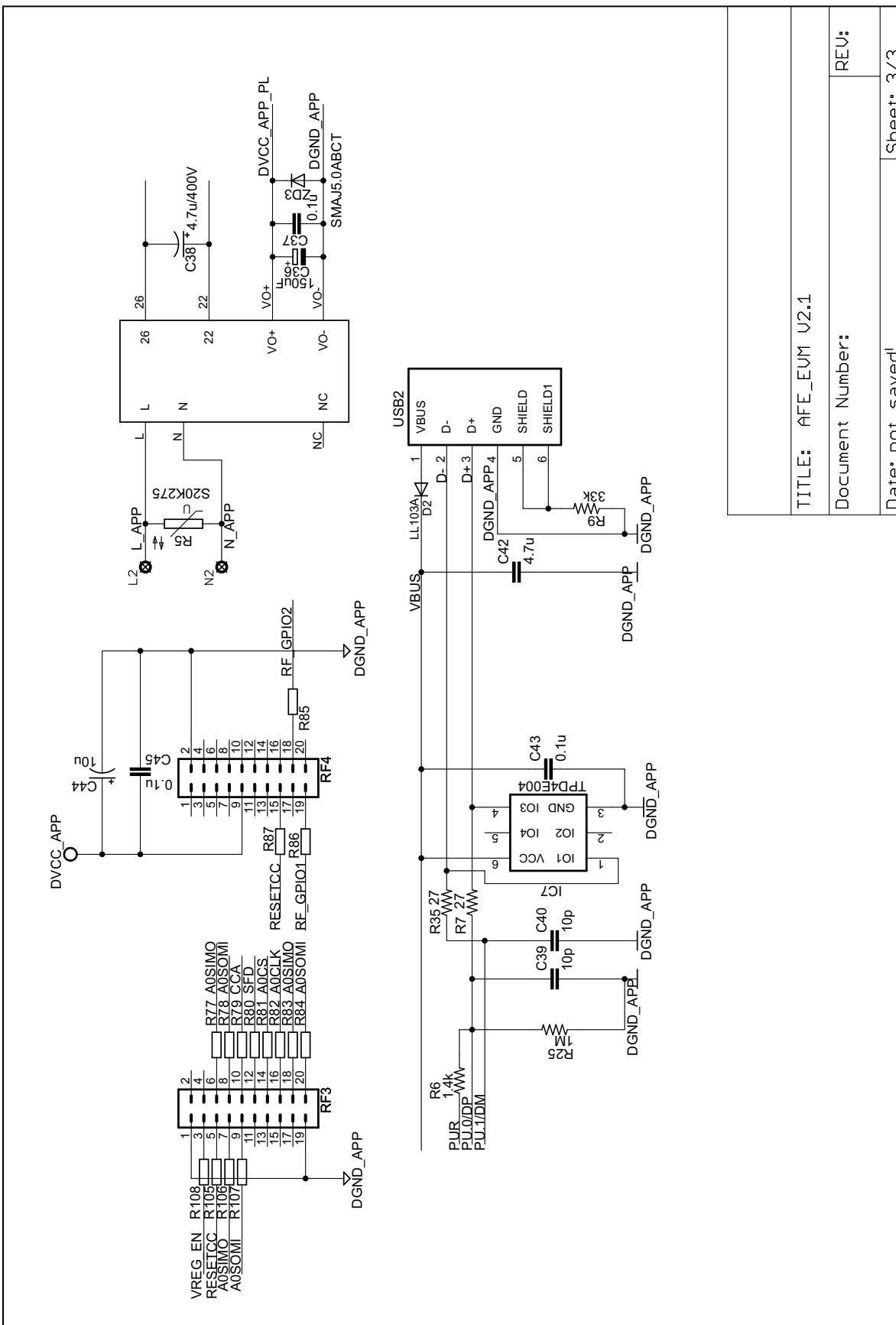

| | |
|---------------------|------------|
| TITLE: AFE_EUM V2.1 | |
| Document Number: | REV: |
| Date: not saved! | Sheet: 3/3 |

9 References

- *MSP430x2xx Family User's Guide* ([SLAU144](#))
- *MSP430AFE2x3, MSP430AFE2x2, MSP430AFE2x1 Mixed Signal Microcontroller Data Sheet* ([SLAS701](#))
- *MSP430 Family Mixed-Signal Microcontroller* ([SLAA024](#))
- *Energy Measurement Results for CTs and Shunts on a TI Designed Meter Using MSP430AFE2xx Devices* ([SLAA536](#))

IMPORTANT NOTICE

Texas Instruments Incorporated and its subsidiaries (TI) reserve the right to make corrections, enhancements, improvements and other changes to its semiconductor products and services per JESD46, latest issue, and to discontinue any product or service per JESD48, latest issue. Buyers should obtain the latest relevant information before placing orders and should verify that such information is current and complete. All semiconductor products (also referred to herein as "components") are sold subject to TI's terms and conditions of sale supplied at the time of order acknowledgment.

TI warrants performance of its components to the specifications applicable at the time of sale, in accordance with the warranty in TI's terms and conditions of sale of semiconductor products. Testing and other quality control techniques are used to the extent TI deems necessary to support this warranty. Except where mandated by applicable law, testing of all parameters of each component is not necessarily performed.

TI assumes no liability for applications assistance or the design of Buyers' products. Buyers are responsible for their products and applications using TI components. To minimize the risks associated with Buyers' products and applications, Buyers should provide adequate design and operating safeguards.

TI does not warrant or represent that any license, either express or implied, is granted under any patent right, copyright, mask work right, or other intellectual property right relating to any combination, machine, or process in which TI components or services are used. Information published by TI regarding third-party products or services does not constitute a license to use such products or services or a warranty or endorsement thereof. Use of such information may require a license from a third party under the patents or other intellectual property of the third party, or a license from TI under the patents or other intellectual property of TI.

Reproduction of significant portions of TI information in TI data books or data sheets is permissible only if reproduction is without alteration and is accompanied by all associated warranties, conditions, limitations, and notices. TI is not responsible or liable for such altered documentation. Information of third parties may be subject to additional restrictions.

Resale of TI components or services with statements different from or beyond the parameters stated by TI for that component or service voids all express and any implied warranties for the associated TI component or service and is an unfair and deceptive business practice. TI is not responsible or liable for any such statements.

Buyer acknowledges and agrees that it is solely responsible for compliance with all legal, regulatory and safety-related requirements concerning its products, and any use of TI components in its applications, notwithstanding any applications-related information or support that may be provided by TI. Buyer represents and agrees that it has all the necessary expertise to create and implement safeguards which anticipate dangerous consequences of failures, monitor failures and their consequences, lessen the likelihood of failures that might cause harm and take appropriate remedial actions. Buyer will fully indemnify TI and its representatives against any damages arising out of the use of any TI components in safety-critical applications.

In some cases, TI components may be promoted specifically to facilitate safety-related applications. With such components, TI's goal is to help enable customers to design and create their own end-product solutions that meet applicable functional safety standards and requirements. Nonetheless, such components are subject to these terms.

No TI components are authorized for use in FDA Class III (or similar life-critical medical equipment) unless authorized officers of the parties have executed a special agreement specifically governing such use.

Only those TI components which TI has specifically designated as military grade or "enhanced plastic" are designed and intended for use in military/aerospace applications or environments. Buyer acknowledges and agrees that any military or aerospace use of TI components which have **not** been so designated is solely at the Buyer's risk, and that Buyer is solely responsible for compliance with all legal and regulatory requirements in connection with such use.

TI has specifically designated certain components as meeting ISO/TS16949 requirements, mainly for automotive use. In any case of use of non-designated products, TI will not be responsible for any failure to meet ISO/TS16949.

Products

| | |
|------------------------------|--|
| Audio | www.ti.com/audio |
| Amplifiers | amplifier.ti.com |
| Data Converters | dataconverter.ti.com |
| DLP® Products | www.dlp.com |
| DSP | dsp.ti.com |
| Clocks and Timers | www.ti.com/clocks |
| Interface | interface.ti.com |
| Logic | logic.ti.com |
| Power Mgmt | power.ti.com |
| Microcontrollers | microcontroller.ti.com |
| RFID | www.ti-rfid.com |
| OMAP Applications Processors | www.ti.com/omap |
| Wireless Connectivity | www.ti.com/wirelessconnectivity |

Applications

| | |
|-------------------------------|--|
| Automotive and Transportation | www.ti.com/automotive |
| Communications and Telecom | www.ti.com/communications |
| Computers and Peripherals | www.ti.com/computers |
| Consumer Electronics | www.ti.com/consumer-apps |
| Energy and Lighting | www.ti.com/energy |
| Industrial | www.ti.com/industrial |
| Medical | www.ti.com/medical |
| Security | www.ti.com/security |
| Space, Avionics and Defense | www.ti.com/space-avionics-defense |
| Video and Imaging | www.ti.com/video |

TI E2E Community

e2e.ti.com