

Capacitive Touch Through Metal Using MSP430™ MCUs With CapTivate™ Technology

Ling Zhu

MSP430 Applications

ABSTRACT

MSP430™ microcontrollers (MCUs) with CapTivate™ technology from Texas Instruments provide a high-sensitivity capacitive touch solution with high reliability and noise immunity at the lowest power.

This application report demonstrates a new capacitive touch application through metal overlays using CapTivate technology. Microscopic movements in a flat metal can be sensed and processed to determine how hard a given button was pressed due to the high sensitivity and resolution of TI's technique. This approach allows reuse of existing metal surfaces commonly found in many applications such as building security systems, appliances, and consumer electronics.

The document describes the fundamentals of TI's CapTivate technology-based metal touch technique and provides guidance on how to design a touch on metal panel with MSP430 MCUs featuring CapTivate technology. Applications and noise immunity considerations are also discussed in this document.

This application report assumes that readers are reasonably familiar with elementary capacitive touch principles, CapTivate technology, and MSP430 microcontroller architecture. Project collateral discussed in this application report can be downloaded from the following URL: www.ti.com/lit/zip/SLAA811.

To learn more about MSP MCUs featuring CapTivate technology, see the [CapTivate Technology Guide](#).

Contents

1	Introduction	4
	1.1 MSP430 MCUs With CapTIvate Capacitive Sensing Technology	4
	1.2 Which Technology to Use in Touch Through Metal Applications?	5
2	Theory of Operation	5
3	System Implementation	7
	3.1 Stackup.....	7
	3.2 Design Consideration	9
4	CapTIvate Technology	16
	4.1 MSP430FR2633 MCU	16
	4.2 CapTIvate Design Center	17
	4.3 Deflection Tool.....	18
5	Touch Through Metal Applications.....	19
	5.1 Button Applications.....	19
	5.2 Wheel Applications	20
	5.3 Slider Applications.....	22
6	Noise Immunity Consideration.....	22
	6.1 Recommendations	23
	6.2 Test Results	24
7	Reference Design	24
	7.1 CAPTIVATE-METAL.....	24
8	References	28

List of Figures

1	Metal Touch Applications	4
2	CapTIvate Sensing Technology	4
3	Parallel Plate Capacitor Formula	5
4	Theory of Capacitive Touch	6
5	Cross-Section of Metal Touch (Untouched).....	6
6	Deflection Due to User Touch.....	6
7	Stackup of Metal Touch.....	7
8	Conductive Layer	7
9	FR4 Spacer.....	8
10	Electrodes on PCB	8
11	Metal Touch Operation.....	9
12	Strain vs Stress.....	10
13	Capacitance vs Spacer Thickness	11
14	Delta Capacitance vs Deflection	11
15	FR4 Standalone Spacer	12
16	Bottom Side Of Metal Overlay With Spacer	12
17	PCB With Spacer.....	12
18	Electrode Shapes	13
19	Hatched Pour Ground on Bottom Side	13
20	Issue Due to Elastic Adhesive.....	14
21	Mechanical Structure Is Not Rigid Enough	14
22	Mechanical With Bracket	14
23	Screws to Reinforce Structure.....	14
24	MSP430FR2633IRHB Pinout.....	16
25	CapTIvate Design Center	17
26	Touch Through Metal Deflection Tool	18
27	Metal Button Applications	19

28	Touch Response	19
29	Metal Touch Button Block Diagram.....	19
30	Metal Wheel Stackup	20
31	Metal Wheel Touch Response	20
32	Metal Wheel Sensor Patterns	21
33	Metal Wheel in Headphone	21
34	Metal Wheel Block Diagram	21
35	Metal Wheel Layout.....	22
36	Metal Touch Slider Block Diagram.....	22
37	Mylar to Protect Electrodes	23
38	CAPTIVATE-METAL	24
39	CAPTIVATE-METAL Electrode Design	25
40	CAPTIVATE-METAL Stackup	25
41	Multi-Touch Demo.....	26
42	Force Touch Demo 1	27
43	Force Touch Demo 2	27

List of Tables

1	CapTivate Technology vs LDC	5
2	Properties of Common Materials.....	10
3	Metal Touch EMC Test Results	24

Trademarks

MSP430, CapTivate are trademarks of Texas Instruments.
 3M is a trademark of 3M.
 Mylar is a registered trademark of DuPont Teijin Films.
 Perspex is a registered trademark of Lucite International.
 All other trademarks are the property of their respective owners.

1 Introduction

Many industrial, automotive, and consumer end-equipment systems and products currently have a metal finish due to its elegant and robust look. However, implementing human machine interfaces (HMIs) on metal surfaces is challenging as it requires machining and cutting a hole to accommodate a mechanical button. In addition to compromising on the elegance of the design, mechanical buttons are also prone to failure in moist, dusty, or dirty conditions.

Touch through metal allows for elegant touch designs that are water-proof, dust-proof, wear-resistant, and highly immune to noise. It also brings the flexibility to work with gloves, and an ability to detect soft and hard touch. Pressure touch through metal is very suitable in building security systems, appliances, industrial applications, and personal electronics.

TI's inductive and capacitive touch technologies offer industrial design technology to add HMI interfaces such as buttons, sliders, and wheels on metal finishes without cutting holes. The sensors are mounted beneath the metal overlay, allowing the design to be completely sealed and immune to dirt and moisture.

TI provides two touch through metal solutions: MSP430 MCUs with [CapTIvate touch technology](#) and the inductance-to-digital converters ([LDC family](#)). This application report describes the key aspects to implement touch through metal using MSP430 MCUs with CapTIvate touch technology.



Figure 1. Metal Touch Applications

1.1 MSP430 MCUs With CapTIvate Capacitive Sensing Technology

CapTIvate technology is a capacitive to digital peripheral integrated inside an MSP430 micro-controller. Because of its high sensitivity to capacitance change, CapTIvate technology also offers support for metal overlays, but uses a change in capacitance to measure deflection of the metal overlay.

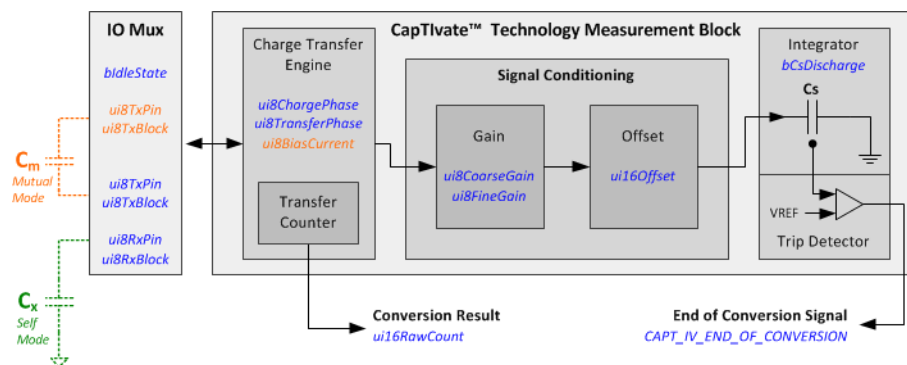

Figure 2. CapTIvate Sensing Technology

Key benefits of MSP430 MCUs with CapTIvate technology include fully programmable MCU with FRAM nonvolatile memory, $3.5\text{-}\mu\text{A}$ average power consumption, high robustness under conducted noise and moisture, and an easy-to-use drag-and-drop tool to tune buttons in 5 minutes or less. An integrated MCU enables a wide range of applications in appliances, industrial, security panels, and consumer electronics.

Because of the high sensitivity to capacitance change, low-power design, high noise immunity performance, and integrated FRAM MSP430 MCU architecture, CapTIvate touch technology through metal enables HMI interfaces such as buttons, sliders, and wheels without cutting holes on metal surfaces.

1.2 Which Technology to Use in Touch Through Metal Applications?

Table 1 is a guide for what TI technology to use where. The choice of technology greatly depends on your design goals.

Table 1. CapTIvate Technology vs LDC

	MSP430 MCUs with CapTIvate touch technology	LDC Inductive sensing	Consider
Family	MSP430FR25xx/FR26xx	LDC211x, LDC131x, LDC161x, LDC0851	
Number of buttons	1 to 16	1 to 8	High count: CapTIvate
Sliders and wheels	Yes	No	CapTIvate MCU
Integrated MCU	Yes	No	CapTIvate MCU
Power	<math><2\ \mu\text{A}</math> (average)	$\approx 26\ \mu\text{A}$ (average)	Lowest power: CapTIvate
Temperature	-40°C to 85°C	-40°C to 125°C	> 85°C : LDC
Link	ti.com/captivate	ti.com/lcd	

If buttons or sliders and wheels are needed with a full featured MCU, consider using CapTIvate technology. For low power consumption design, consider an MSP430 MCU with CapTIvate technology. If you are looking for 125°C and Q100 qualified products, LDC products should be considered.

This document discusses details about a capacitive-based approach for implementing metal touch using MSP430 MCUs with CapTIvate technology.

2 Theory of Operation

Figure 3 shows the capacitance of a simple parallel-plate capacitor.

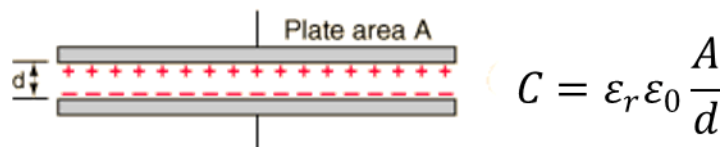

Figure 3. Parallel Plate Capacitor Formula

Where,

C is the capacitance, in Farads

A is the area of overlap of the two plates, in square meters

ϵ_r is the relative static permittivity of the material between the plates (for a vacuum, $\epsilon_r = 1$)

ϵ_0 is the electric constant ($\epsilon_0 \approx 8.854 \times 10^{-12} \text{ Fm}^{-1}$)

d is the separation between the plates, in meters

In general capacitive touch systems, the sensor pad forms one side of a parallel capacitor and the user's finger then forms the second side of the capacitor (see [Figure 4](#)). When the user brings a finger close to the sensor pad, the distance (d) between the finger and sensor pad decreases, and (according to the parallel-plate capacitor formula) the capacitance (C) increases. For electrostatic discharge (ESD) and isolation reasons, it is standard practice to use a nonconductive front panel overlay above the sensor pads.

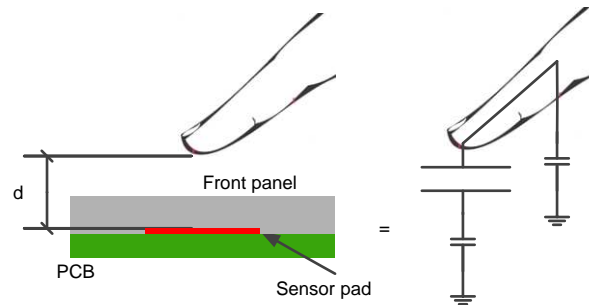

Figure 4. Theory of Capacitive Touch

The operation theory of CapTIvate technology-based capacitive metal touch is similar to general capacitive touch. The concept of the parallel-plate capacitor still applies, and the sensor measures the change in capacitance between two plates. Touch on metal differs by implementing a conductive overlay material, instead of a finger, suspended over the capacitive touch sensors to form the second plate of the capacitor being measured. An air gap is created between the conductive overlay and the sensor electrode by implementing a spacer layer. [Figure 5](#) shows the cross-section view of a typical touch through metal overlay stackup.

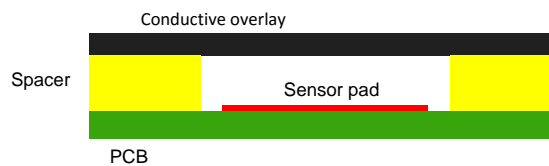

Figure 5. Cross-Section of Metal Touch (Untouched)

When the user applies a force on the conductive metal above the sensor electrode, it causes the material to have a very slight local deformation. This deformation changes the distance (d) between the two plates of the capacitor being measured (see [Figure 6](#)). To keep the conductive overlay at a fixed potential, it should be grounded. Because the potential is fixed, the human body parasitic capacitance no longer affects the measurement, and the sole variable now being measured is the distance (d) between the plates. This architecture can avoid common-mode conducted noise by passing the noise to ground, and water no longer affects the touch. Because the measurement value is representative of a mechanical deformation, the magnitude of the change in measurement is a function of the pressure a user applies to the overlay when touching the sensor. This allows users to wear gloves with no effect on the performance and reliability of the touch button.

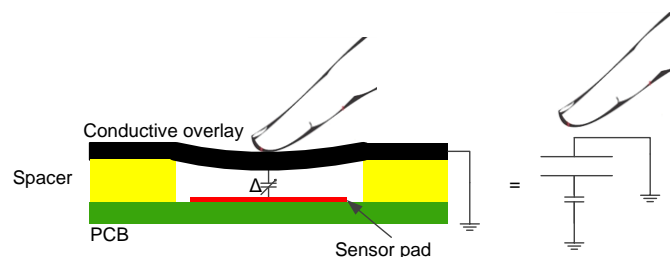

Figure 6. Deflection Due to User Touch

3 System Implementation

To construct a touch through metal system with the optimal performance, the following should be considered:

- **Mechanical design:** Mechanical structure plays a very important role in capacitive metal touch design. The quantity, size, and arrangement of buttons as well as the optimal target-to-sensor spacing can influence the response of the system.
- **Assembly:** Assembly of the system to achieve optimal performance and avoid false triggers
- **Metal grounding:** Best practices to metal grounding to ensure that the metal layer remains at a fixed potential
- **Other considerations:** Power consumption, detection algorithms to automatically adjust for long-term drift or permanent mechanical changes, and noise immunity

3.1 Stackup

Typically, there are 3 layers in a touch through metal system. The top layer is a conductive overlay material, usually a metal plate. The middle layer is spacer with cut-outs over the sensor electrodes to allow for a deflection of the top conductive overlay at predetermined positions. The bottom layer is the PCB with the sensor electrodes implemented as copper pours.

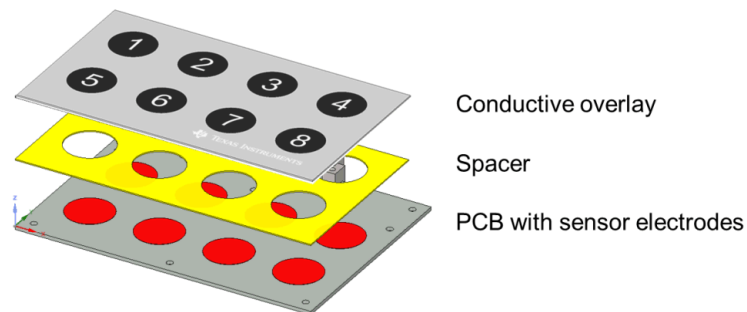

Figure 7. Stackup of Metal Touch

3.1.1 Conductive Layer

The conductive layer provides water-proof, dust-proof, and wear resistant features. Typical materials for the conductive layer include aluminum or stainless steel. The metallic overlay may have graphics silk-screened or printed on the surface to identify the locations of sensors to the user.

The conductive overlay should be kept at a fixed potential. It is recommended to ground the overlay to ensure that the overlay remains at a fixed potential. Floating the overlay significantly compromises robustness and noise immunity.



Figure 8. Conductive Layer

3.1.2 Spacer Layer

The spacer layer exists to create an air gap between the conductive overlay and the sensing electrodes. Typically, it is an insulating sheet with cutouts that are aligned with the sensor electrodes on the PCB layer. Materials for spacer should be rigid to prevent compression. Recommended materials include FR4, Perspex®, or noncompressing film (see [Figure 9](#)). The selected material should not deform with the overlay when the user presses on the overlay.

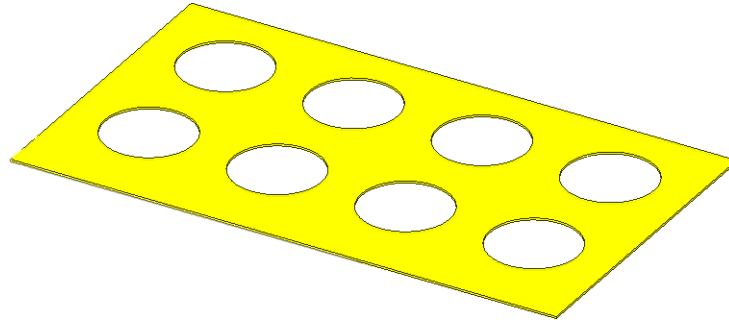

Figure 9. FR4 Spacer

3.1.3 PCB Layer

Sensor electrodes on the PCB form a capacitor with the conductive overlay, which represents ground. As shown in [Figure 10](#), sensor electrodes typically consist of copper fills on FR4 PCB material.

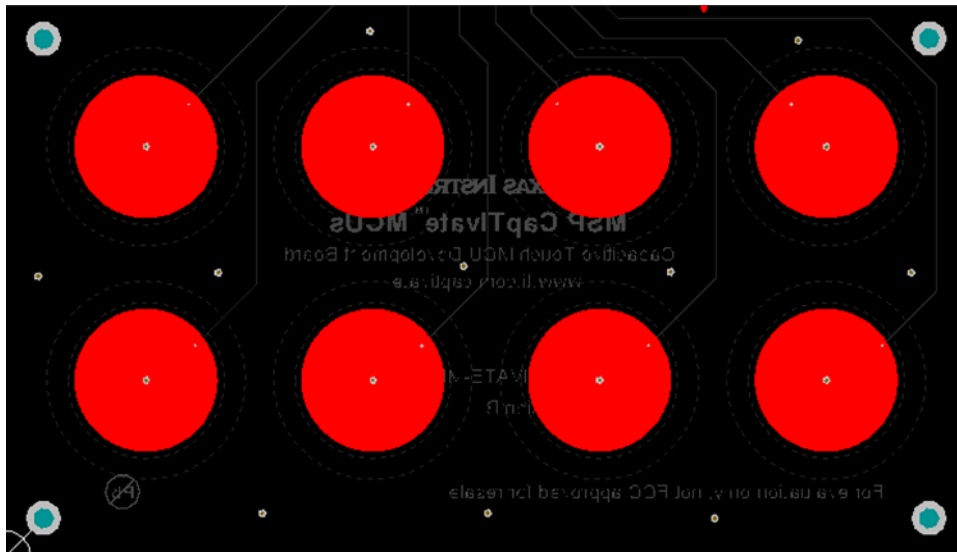

Figure 10. Electrodes on PCB

3.2 Design Consideration

This section describes design consideration of touch through metal implementation, provide recommendations and design guide as well.

Figure 11 shows the metal touch operation diagram.

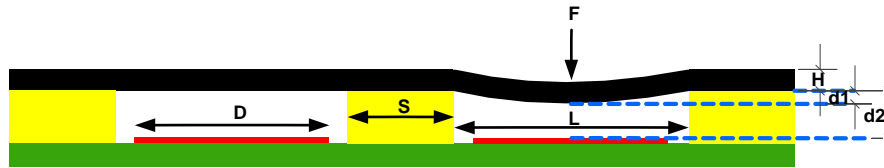

Figure 11. Metal Touch Operation

D is the diameter of electrode,

S is clearance between buttons,

L is the diameter of spacer hole,

H is the thickness of conductive overlay,

F is the force applying to the conductive overlay,

d1 is the deflection of overlay due to the force applied,

d2 is the thickness of spacer.

From the diagram, the delta capacitance due to a touch depends on parameters **d1** and **d2**.

d1 is determined by the material and thickness of the conductive overlay.

d2 is determined by thickness of spacer.

All the parameters are discussed in detail in the following sections. A deflection tool (see [Section 4.3](#)) helps choose the proper design parameters.

3.2.1 Conductive Overlay

When properly designed, the user's press on the desired area of the conductive overlay should create a *measurable* but *nonpermanent* deflection.

- *Measurable* means that overlay material should be soft enough to deform enough by user's touch. It has relationship with material property which called Young's modulus. Young's modulus is independent of the geometry of the material. It defines how force relates to strain.
- *Nonpermanent* means that overlay material should have high yield strength.

More details about Young's modulus and yield strength can be found at

https://en.wikipedia.org/wiki/Young%27s_modulus.

Figure 12 shows an example strain vs stress diagram.

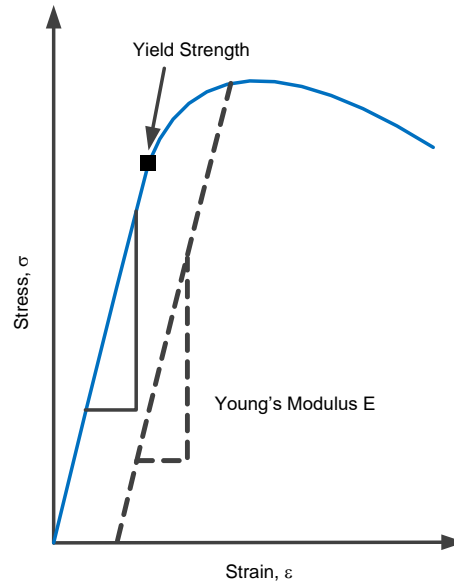

Figure 12. Strain vs Stress

Table 2 lists the Young's modulus and yield strength of common conductive materials.

Table 2. Properties of Common Materials

Material	Young's Modulus, E (GPa) ⁽¹⁾	Yield Strength, σ_y (MPa)
Aluminum	69	95
Steel	200	250 to 165
Copper	100 to 128	70
Titanium	105 to 120	73

⁽¹⁾ Pa = 1 N/m

Balancing Young's modulus and yield strength provides the trade-off between the size of the buttons, the minimum actuation force, and the type of material used for the target.

The most common metal materials used by consumer and industrial systems are stainless steel and aluminum. Benefitting from the high sensitivity and resolution of CapTivate technology, the touch through metal application works well with both materials. Micrometer-scale deflections can be detected by the CapTivate technology-based solution. Within the yield strength of the overlay material, the larger the deflection (d_1) is, the more sensitive the electrode will be to a touch. The deflection tool (see Section 4.3) can be used to calculate overlay deflection according to the material parameters.

The conductive overlay should be electrically connected to either earth ground or circuit common ground.

3.2.2 Spacer

The two main considerations for the spacer are thickness and the material used.

Spacer thickness (d_2) determine base capacitance of the parallel capacitor. [Figure 13](#) shows the capacitance versus spacer thickness where L equals 20 mm.

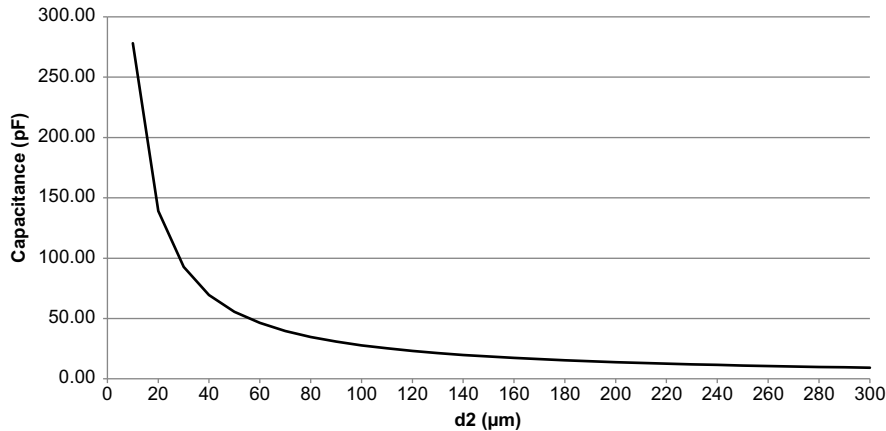

Figure 13. Capacitance vs Spacer Thickness

Capacitive touch detection is based on measuring the delta in capacitance when the sensor is touched versus untouched. The larger delta is, the better performance will be. [Figure 14](#) shows the delta in capacitance versus deflection while keeping spacer thickness constant.

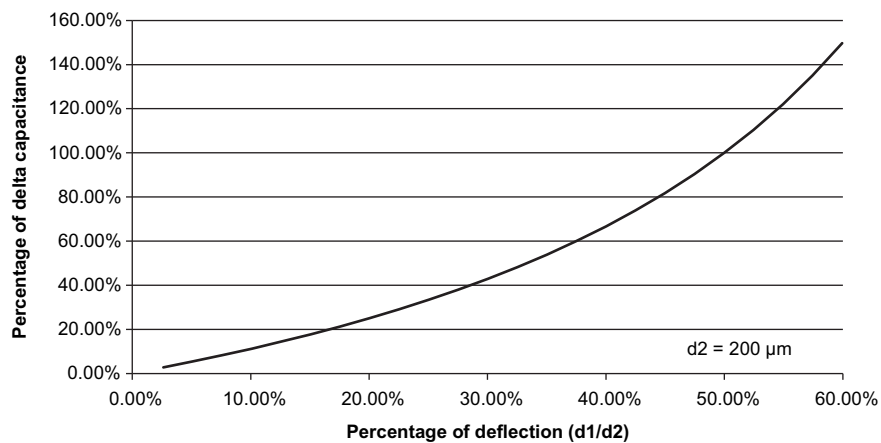

Figure 14. Delta Capacitance vs Deflection

To create a sensitive touch sensor, the deflection required in the top layer material should be at least 5% of the thickness of the spacer. Due to the existence of parasitic capacitance, deflection is not linearly equivalent to change in capacitance. Ideally, a larger deflection would yield a higher SNR.

For ease of use, the buttons should not be too small. The cut-out size in the spacer layer is recommended to be at least 10 mm, which is the size of human finger. And also ensure cut-out size is larger than sensor pad size. This increases the area which is deflected towards the sensor pad, in essence, increasing the change in capacitance. Usually, $L = D + 2$ mm at least.

The material for the spacer should be rigid to prevent compression. The selected material should not deform with the overlay when the user presses on the overlay.

There are three ways to implement the spacer layer in a touch on metal design:

1. A simple standalone spacer made of FR4 or other rigid material (see [Figure 15](#)).

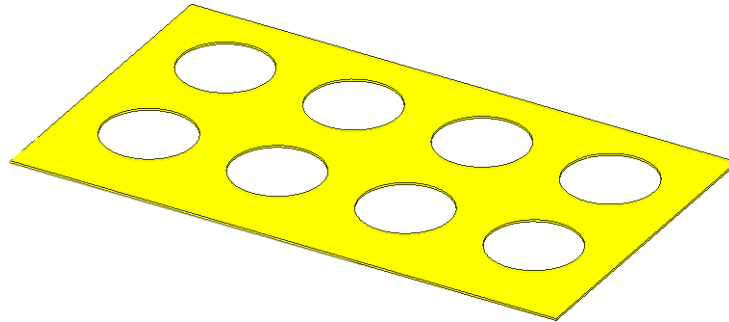

Figure 15. FR4 Standalone Spacer

2. A spacer incorporated into the conductive layer, consisting of etched blind holes in the bottom side of the metal overlay (see [Figure 16](#)).

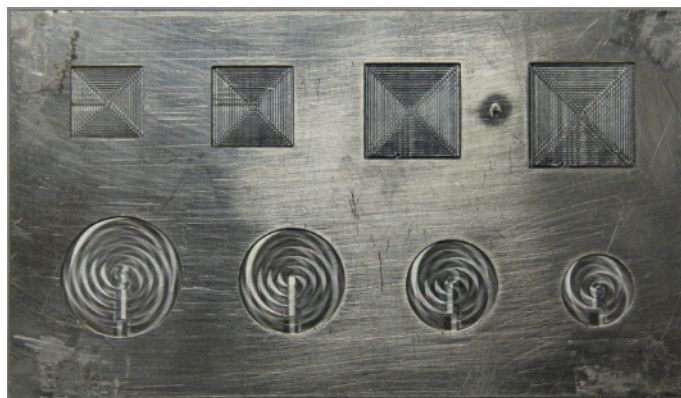

Figure 16. Bottom Side Of Metal Overlay With Spacer

3. A spacer incorporated into the PCB, growing prepreg during PCB fabrication (see [Figure 17](#)).

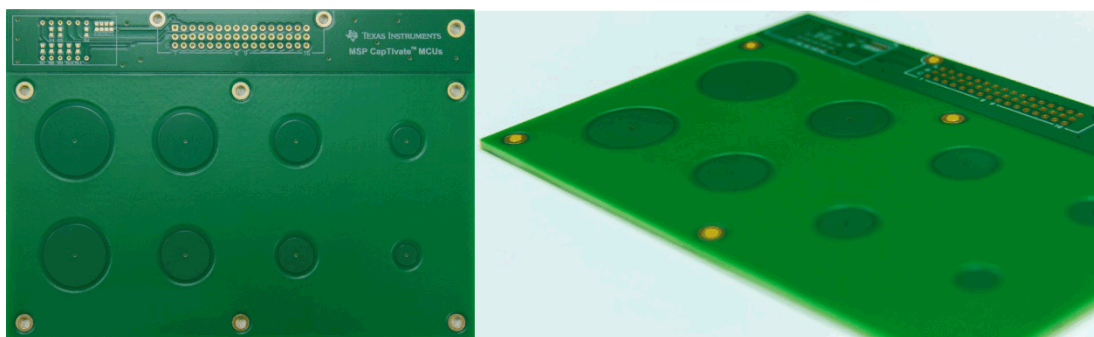

Figure 17. PCB With Spacer

Recommended spacer thickness is 0.1 to 0.5 mm. The 0.1-mm thickness is the optimal value for the spacer for metal deflection while balancing button sensitivity, which rapidly decreases when the spacer is larger than 0.5 mm.

A spreadsheet is available with this application report and computes the equations that affect performance: actuation force, overlay and spacer thickness, and sensor size.

3.2.3 Sensor Design

The sensor pad (also referred to as the electrode), typically consists of copper fills on FR4 PCB material.

Size and shape

According to the parallel-plate capacitor formula, the size of the sensor pad determines the area of the parallel-plate capacitor. The recommended sensor pad area is larger than 100 mm², which is similar in size to a human finger. The larger the pad is, the more sensitive it will be. The recommended shape of sensor pad is round or square.

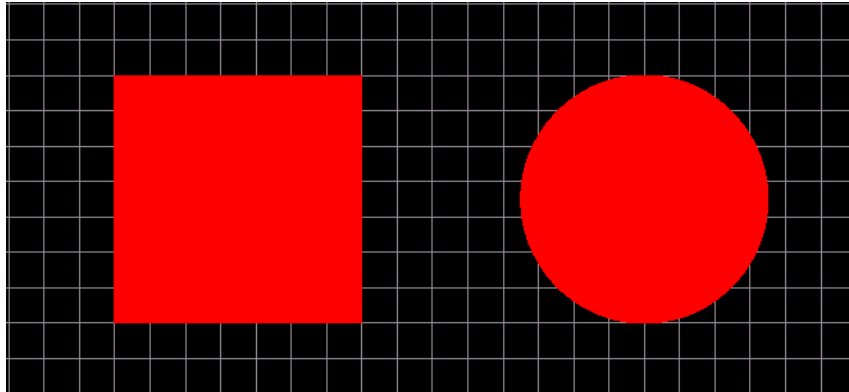

Figure 18. Electrode Shapes

Spacing between buttons

The clearance between sensor pads (S) should be designed so that a force applied on one button does not have an effect on an adjacent button. The clearance between buttons is typically 50% or more of the sensor pad diameter for the best isolation.

Ground layout

Surrounding ground planes on the bottom side help with noise immunity and avoid false triggers when a user touches the bottom side, but they affect the sensitivity of the electrode. The use of a hatched pour instead of a solid ground pour is a good design practice (see Figure 19). This reduces the area and consequently the parasitic capacitance. Typically, a 25% fill hatch is sufficient, but this percentage can be increased or decreased to improve noise immunity or sensitivity, respectively.

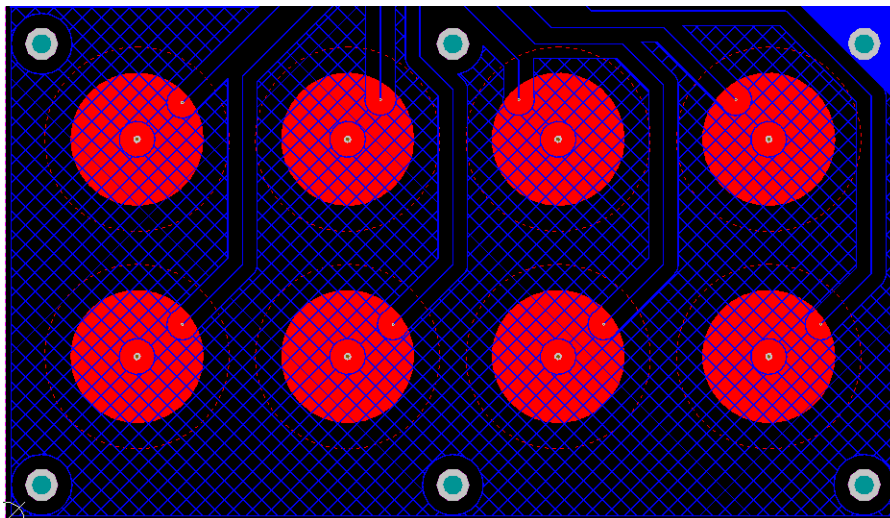

Figure 19. Hatched Pour Ground on Bottom Side

3.2.4 Assembly

Adhesives are used to merge the different layers together, and they play an important role in enhancing the mechanical strength.

The bonding of the metal plate and the PCB should be firm to avoid crosstalk between buttons. For permanent adhesion, it is best to use nonelastic adhesive. When a force is applied to a button, it may cause the overlay of adjacent button to lift if the top layer is too stiff or the adhesive is elastic (see [Figure 20](#)).

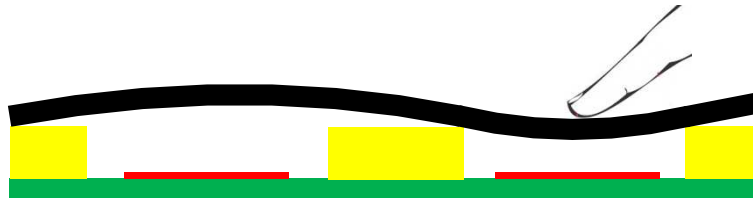

Figure 20. Issue Due to Elastic Adhesive

In most applications, if the mechanical structure of the system is not rigid enough, the whole structure will deform downwards during a user press (see [Figure 21](#)).



Figure 21. Mechanical Structure Is Not Rigid Enough

For this reason, it is strongly recommended to have a backing support that keeps the PCB placed uniformly against the spacer layer (see [Figure 22](#)).

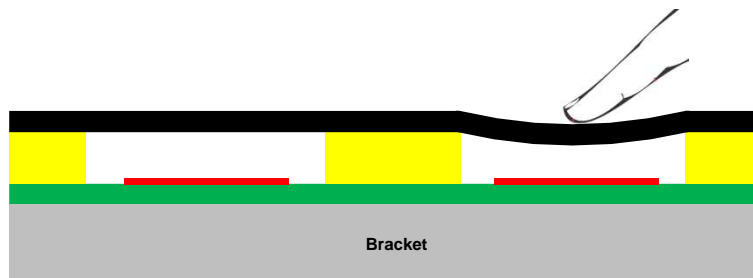

Figure 22. Mechanical With Bracket

Screws are another option to reinforce the structure. Conductive screws also can be used to ground the overlay to the circuit common ground (see [Figure 23](#)). Other solutions can also be used for grounding purpose.

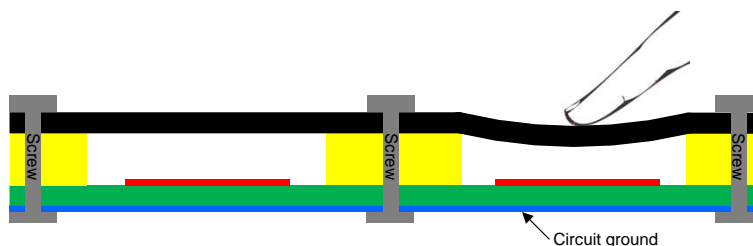

Figure 23. Screws to Reinforce Structure

3.2.5 Software

The software development of CapTivate technology for metal overlays is exactly the same as normal capacitive touch.

TI provides the CapTivate Software Library to help the customer shorten the development process when working with MSP430 MCUs with CapTivate technology.

The library provides the following features:

- Hardware abstraction of the CapTivate peripheral features
- Processing of button, slider, wheel, and proximity sensors with simple callback reporting when measurement and processing are complete
- User interface management to enable a simple top level API that is easy to use
- Electromagnetic compatibility features for improving noise immunity
- Communications infrastructure for connecting an MSP430 MCU to the CapTivate Design Center during tuning or to a host processor in an application

All of the source code can be generated by CapTivate Design Center (see [Section 4.2](#)), including noise-immunity algorithms and detection algorithms to automatically adjust for long-term drift or permanent mechanical changes.

4 CapTivate Technology

CapTivate technology is a capacitive user interface design ecosystem that takes the next big step in design process evolution. It brings together a capacitive measurement technology, a design GUI, a capacitive touch software library, and a hardware development platform.

For more details, see [Getting Started With MSP MCUs With CapTivate™ Technology](#) and <http://www.ti.com/captivate>.

4.1 MSP430FR2633 MCU

The MSP430FR263x and MSP430FR253x MCUs are FRAM-based ultra-low-power MSP430 microcontrollers that feature CapTivate touch technology for buttons, sliders, wheels, and proximity applications. [Figure 24](#) shows the pinout of the [MSP430FR2633 MCU](#) in the RHB (VQFN) package.

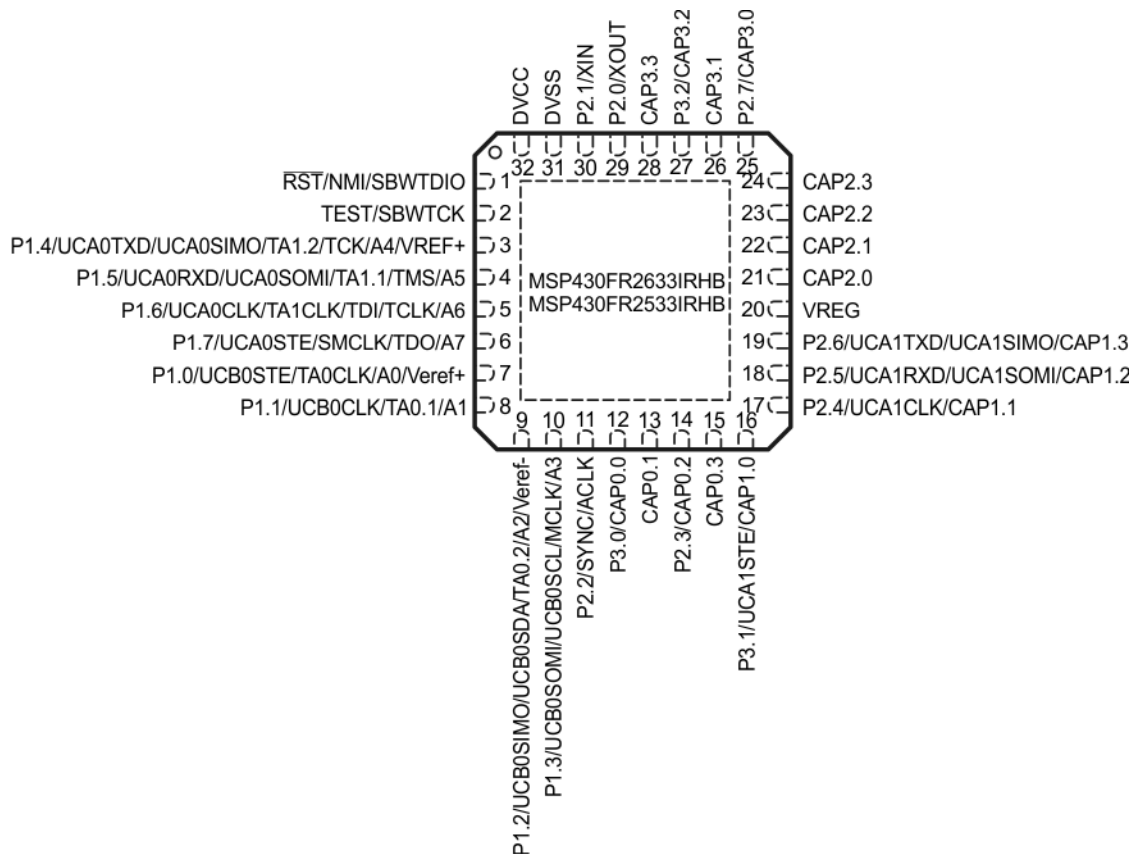

Figure 24. MSP430FR2633IRHB Pinout

Key features of the MSP430FR263x and MSP430FR253x MCUs include:

- Support up to 16 touch through metal buttons
- Support for touch through metal wheel and slider
- $1.7 \mu\text{A}$ per button average
- Up to 15.5KB FRAM
- Up to 4KB RAM

For more details, see [MSP430FR263x, MSP430FR253x Mixed-Signal Microcontrollers](#).

4.2 CapTIvate Design Center

The CapTIvate Design Center is a rapid development tool that accelerates capacitive touch designs using MSP430 MCUs with CapTIvate technology. By helping guide the product developer through the capacitive touch development process, the CapTIvate Design Center can simplify and accelerate any touch design through the use of innovative user graphical interfaces, wizards, and controls.

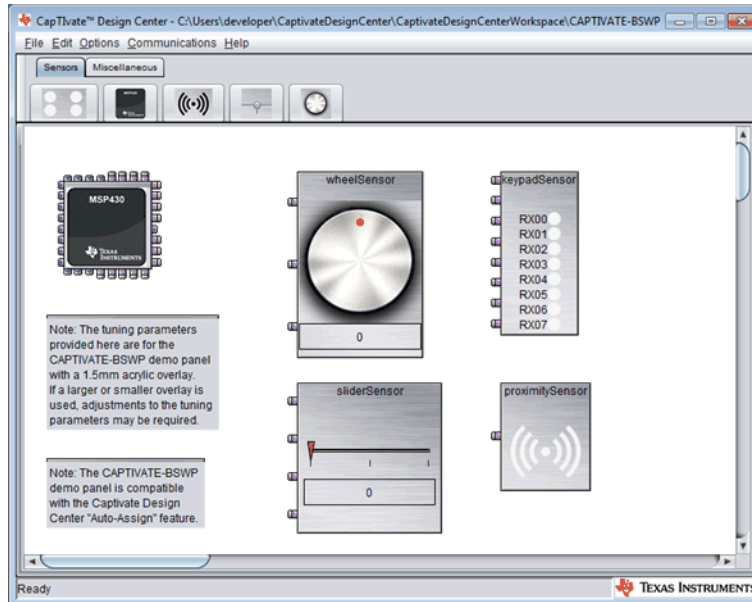

Figure 25. CapTIvate Design Center

Features of the CapTIvate Design Center include:

- Intuitive GUI tools for creating, configuring, and defining the MSP430 MCU connections for sensors
- Support for slider, wheel, button group, and proximity sensors
- Support mutual- and self-capacitive sensor types in the same design
- Automated generation of complete source code projects for CCS and IAR IDEs
- Real-time target communication through a HID communication bridge, which allows users to:
 - View detailed sensor data
 - Configure and tune sensor performance
 - Perform SNR measurements

For more details, visit the [Design Center user's guide](#).

4.3 Deflection Tool

The deflection tool is specifically designed for capacitive metal touch development. It is used to calculate metal overlay deflection according to user input, and it helps to choose proper design parameters to achieve a good user experience.

NOTE: This tool calculation result is for reference only, because the real mechanical structure may be different from the ideal model used in the deflection tool.

The Deflection Tool is a spreadsheet (available from <http://www.ti.com/lit/zip/slaa811>) that computes the equations for actuation force, overlay and spacer thickness, and sensor size.

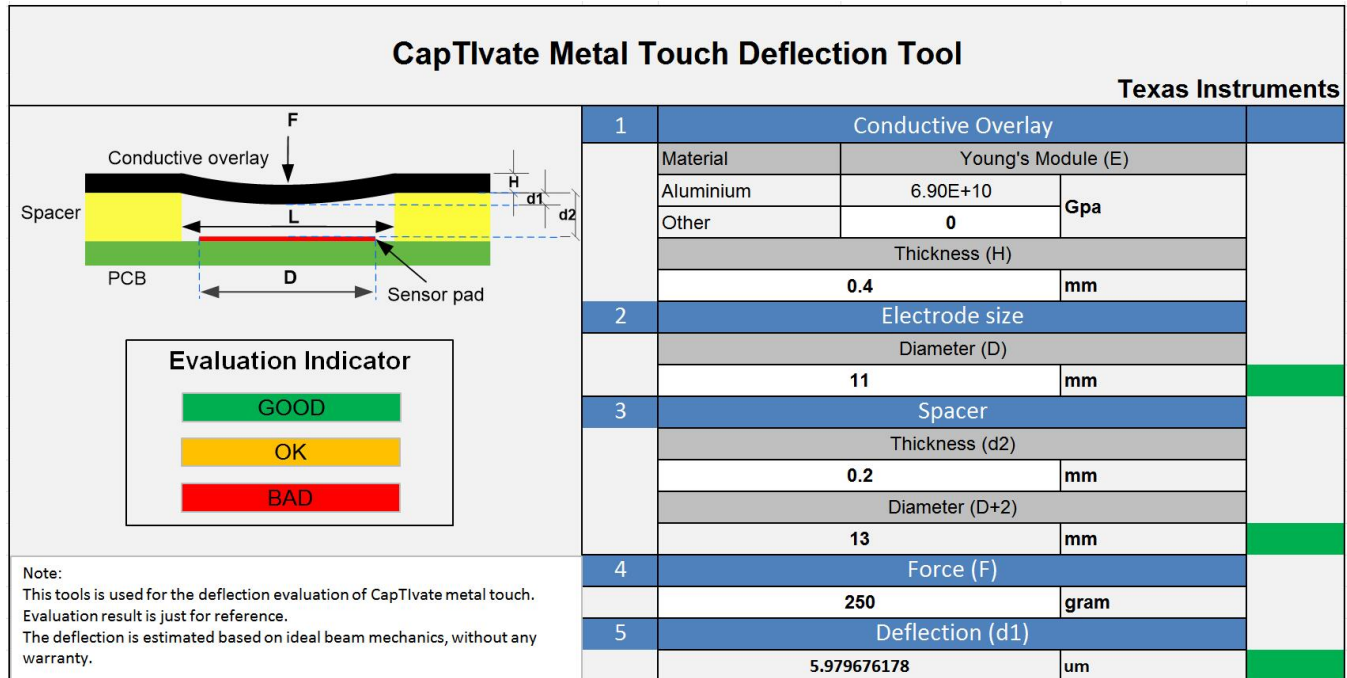

Figure 26. Touch Through Metal Deflection Tool

5 Touch Through Metal Applications

This section describes typical applications for capacitive touch through metal.

5.1 Button Applications

A button is the most commonly used capacitive metal touch application. A capacitive touch through metal button design is almost the same as general capacitive touch. By utilizing touch through metal instead of traditional capacitive touch, the application can benefit from waterproof and dust proof features and can be widely used in kitchen applications and white goods.



Figure 27. Metal Button Applications

Metal buttons also support force touch detection, which differentiates between soft touches and hard touches, because applying different force to the button causes different delta counts (the red bar in Figure 28).

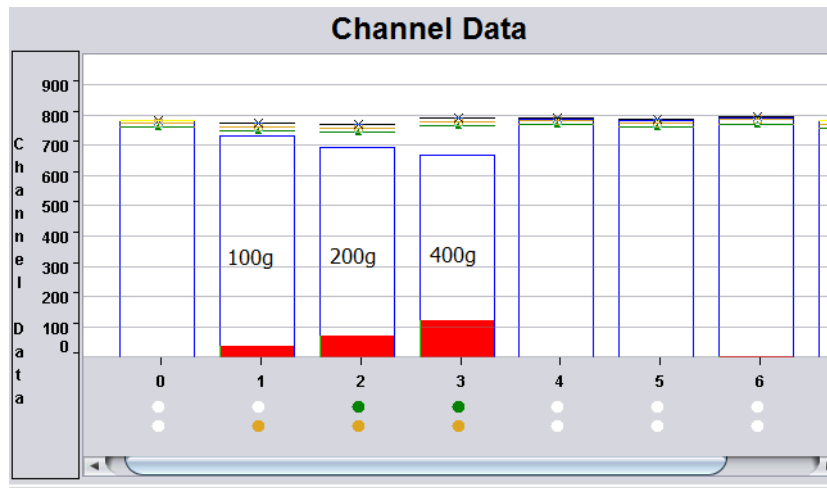

Figure 28. Touch Response

Figure 29 shows the capacitive metal touch button application block diagram. All the buttons are self-capacitive buttons. The MSP430FR2633 MCU can support up to 16 metal touch buttons.

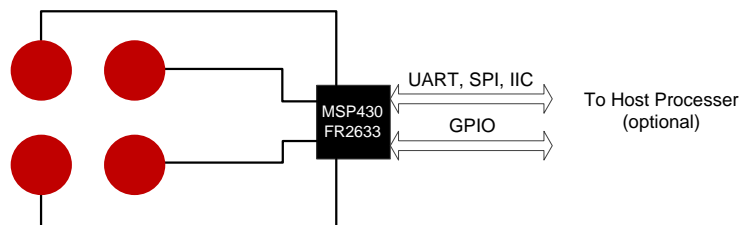

Figure 29. Metal Touch Button Block Diagram

The CAPTIVATE-METAL EVM provides a reference for capacitive touch metal button application design. See Section 7 for more information about this EVM.

5.2 Wheel Applications

A metal wheel is another capacitive metal touch application. The capacitive touch through metal wheel structure is a little different from the metal touch button structure. In the metal wheel application, only one cut-out is in the spacer layer, and all of the electrodes share this cut-out.

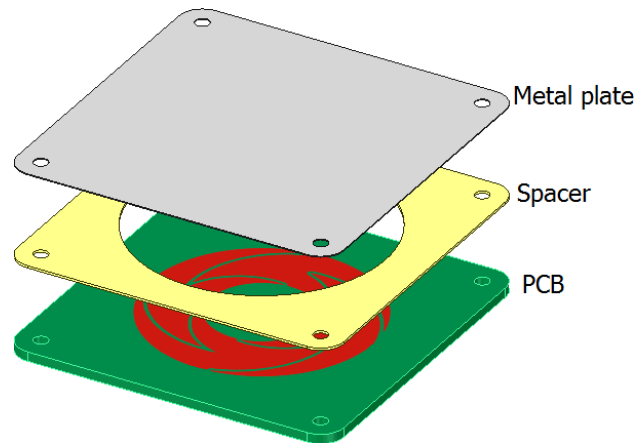

Figure 30. Metal Wheel Stackup

The response and process of metal wheels is very similar to normal wheel sensors. The only difference is that when the metal wheel panel is touched, all the electrodes of this wheel sensor are in touch status. The firmware calculates absolute position according to the different response of each electrode (the red bar in Figure 31).

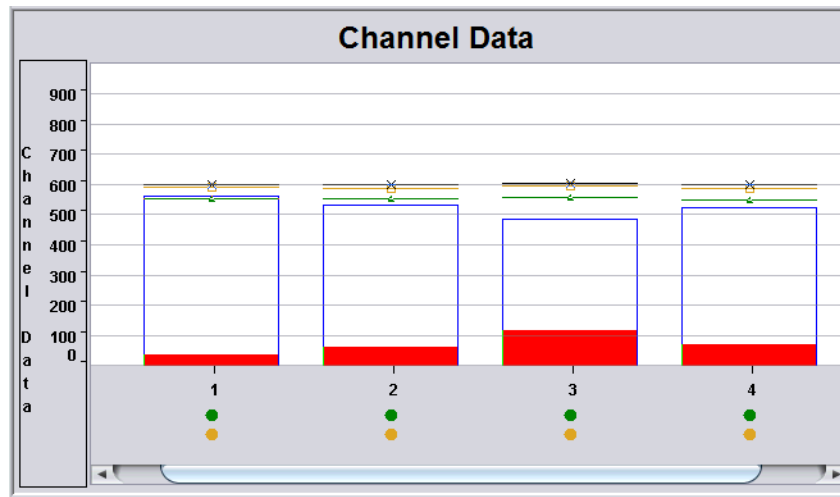

Figure 31. Metal Wheel Touch Response

Figure 32 shows two wheel patterns that can be used in metal wheel application.

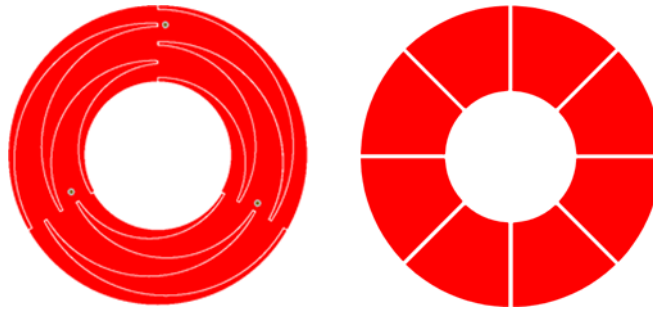
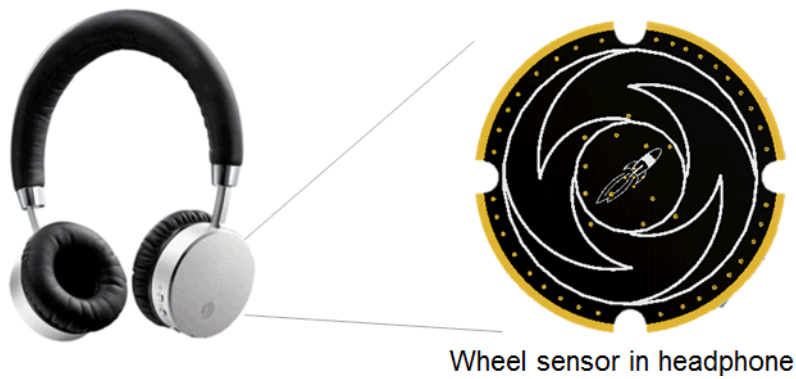

Figure 32. Metal Wheel Sensor Patterns

A touch on metal wheel can be used in many user interfaces such as high-end metal case headphones and audio players that support gesture control through a series of swipes and taps on the metal casing (see Figure 33).



Wheel sensor in headphone

Figure 33. Metal Wheel in Headphone

Figure 34 shows the capacitive touch metal wheel application block diagram.

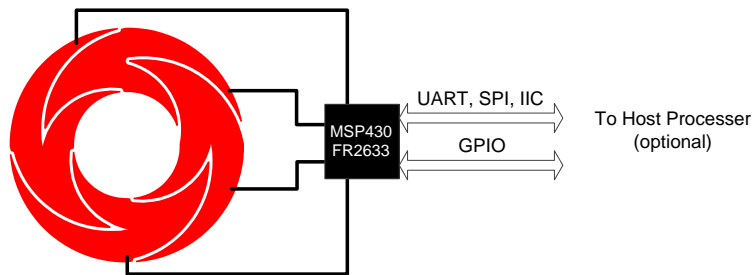

Figure 34. Metal Wheel Block Diagram

Figure 35 shows the recommend layout for metal wheel application.

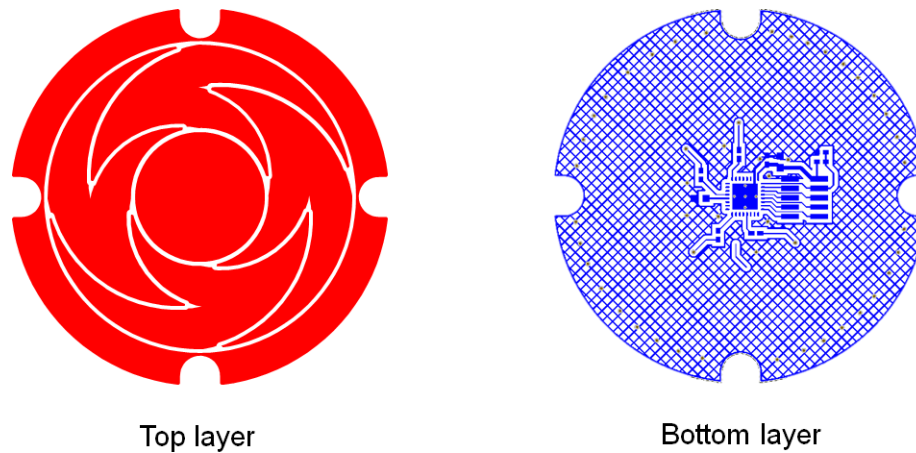

Figure 35. Metal Wheel Layout

5.3 Slider Applications

The capacitive metal touch slider application is similar to the metal wheel. In the capacitive touch through metal slider structure, all the electrodes share one spacer cut-out. Figure 36 shows a metal touch slider block diagram.

Capacitive metal sliders can be used in high-end metal-case speakers for menu and volume adjustment, as well as panels on industrial machines that need to be dust proof and work with gloved hands.

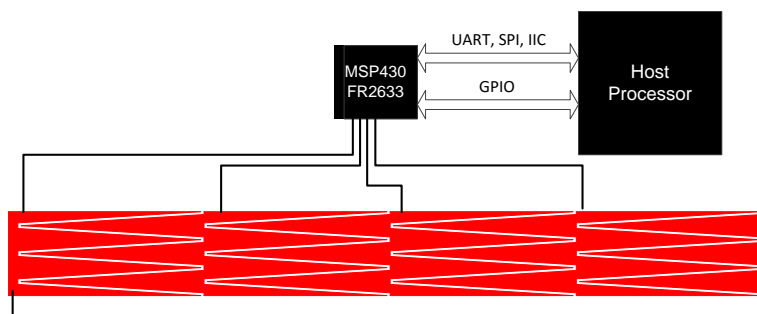

Figure 36. Metal Touch Slider Block Diagram

6 Noise Immunity Consideration

Capacitive touch is rapidly becoming a popular technology for mechanical button replacement in end equipment such as small and large home appliances, industrial control panels, and automotive center stacks. Noise immunity becomes more and more important in touch application. The main noise sources in capacitive touch applications are conducted noise, electrical fast transients, and electrostatic discharge per the IEC 61000-4-6, IEC 61000-4-4, and IEC 61000-4-2 system-level standards, respectively.

For MSP430 MCUs with CapTIvate technology, there are two aspects to improve EMC noise immunity performance: *power design* and *MCU protection*.

The power design of CapTIvate technology with metal overlays is almost the same as general capacitive touch designs. The [Noise Tolerant Capacitive Touch HMI reference design \(TIDM-CAPTOUCHEMCREf\)](#) demonstrates how to design a capacitive touch interface with the MSP430FR2633 MCU to meet strict electromagnetic compatibility (EMC) requirements at a system level. For more details, see [Enabling Noise Tolerant Capacitive Touch HMIs with MSP CapTIvate™ Technology](#).

This section mainly discusses *MCU protection*.

6.1 Recommendations

EFT and conducted noise performance depends on power supply design and software algorithms, which has been discussed in [Enabling Noise Tolerant Capacitive Touch HMI with MSP CapTIvate™ Technology](#). ESD immunity is most critical part in capacitive touch through metal design because ESD strikes can be directly discharged to the metal overlay material.

Recommendations to improve system ESD performance:

- Connect the metal plate to earth. Provide ESD a path to ground.
- Keep earth ground, metal plate, and circuit ground as close as possible.
- Keep the MSP430 MCU away from the metal plate, out of the ESD path.
- Put a 22- μ F to 47- μ F capacitor and a TVS diode on the MCU power pin to enhance noise immunity performance.
- Set the MCU reset pin in NMI mode to increase ESD immunity.
- To protect capacitive IO, TI recommends adding a series resistor near the MCU. And if the sensor itself will be exposed to significant ESD, a low-capacitance TVS diode should be placed on the sensor trace before the series resistance.
- Add a Mylar® sheet between electrodes and conductive overlay improves the ESD immunity, as shown in [Figure 37](#).

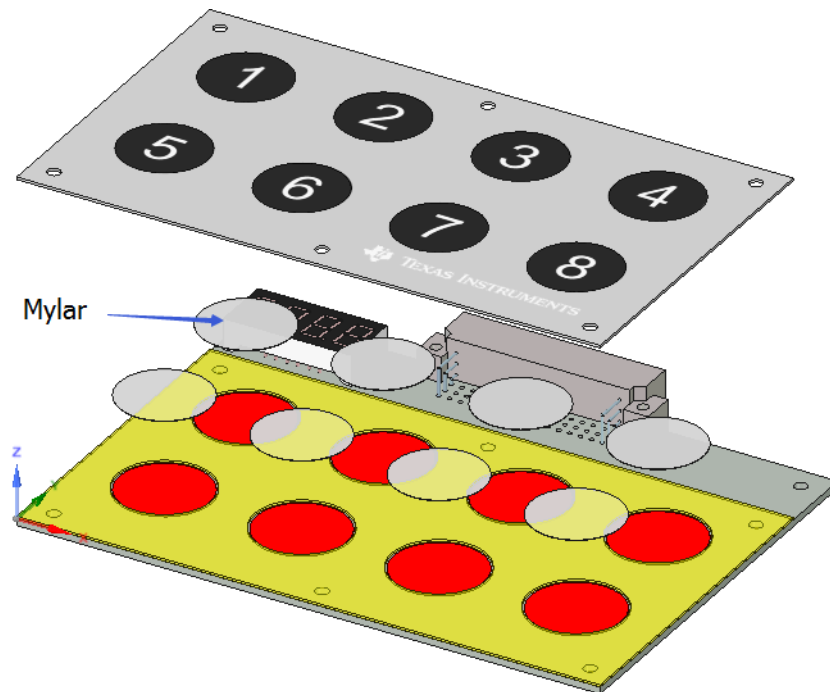

Figure 37. Mylar to Protect Electrodes

6.2 Test Results

Table 3 lists the EMC test results.

Table 3. Metal Touch EMC Test Results

Equipment Under Test	Test	Stress Level	Pass Criteria ⁽¹⁾
CAPTIVATE-METAL RevG	Electrostatic discharge immunity (IEC 61000-4-2)	±8 kV contact	Class A
	Electrical fast transient/burst immunity (IEC 61000-4-4)	4 kV at 5 kHz	Class A
	Conducted immunity (IEC 61000-4-6)	10 Vrms	Class A

⁽¹⁾ The following capacitive-touch specific pass/fail criteria were used for testing:

Class A: The equipment under test (EUT) operates as intended with no degradation of performance during the test or after the test.

Class B: The EUT experiences a temporary loss of function or degradation of performance during the test. This degradation of performance ceases after the test, after which the EUT recovers on its own without operator intervention.

Class C: The EUT experiences a loss of function or degradation of performance during the test which it does not recover from after the test stimulus is removed. The full functionality can be recovered by disconnecting and reconnecting power to the EUT.

7 Reference Design

7.1 CAPTIVATE-METAL

The Touch on Metal Capacitive Sensing Add-on Board for the CapTIvate™ Development Kit ([CAPTIVATE-METAL](#)) is an add-on board to the MSP CapTIvate MCU development kit ([MSP-CAPT-FR2633](#)). CAPTIVATE-METAL is a reference design of a touch through metal button application using the MSP430FR2633 MCU.

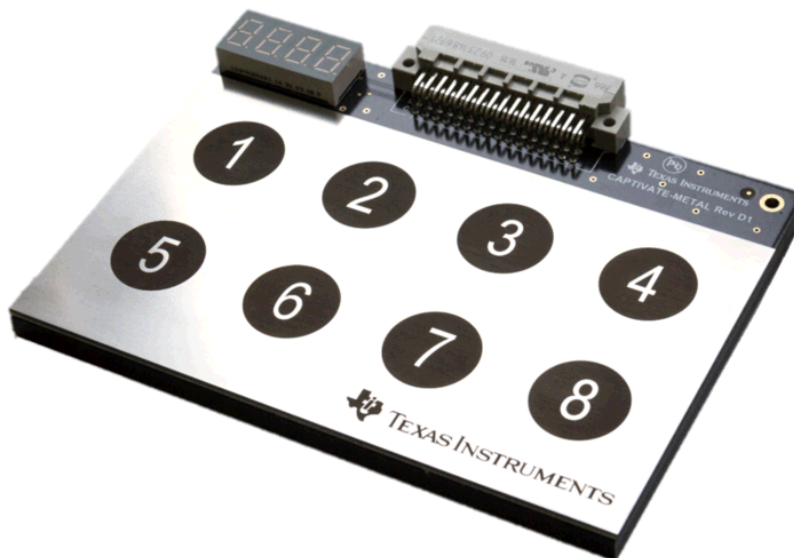

Figure 38. CAPTIVATE-METAL

Features of CAPTIVATE-METAL include:

- 8 metal touch buttons
- 4-digit 7-segment display
- Standard CapTIvate EVM connector
- Demonstrate single touch, composite touch, and force touch

7.1.1 Hardware Design Parameters

- Electrode diameter: 20 mm
- Space between electrodes: 12 mm

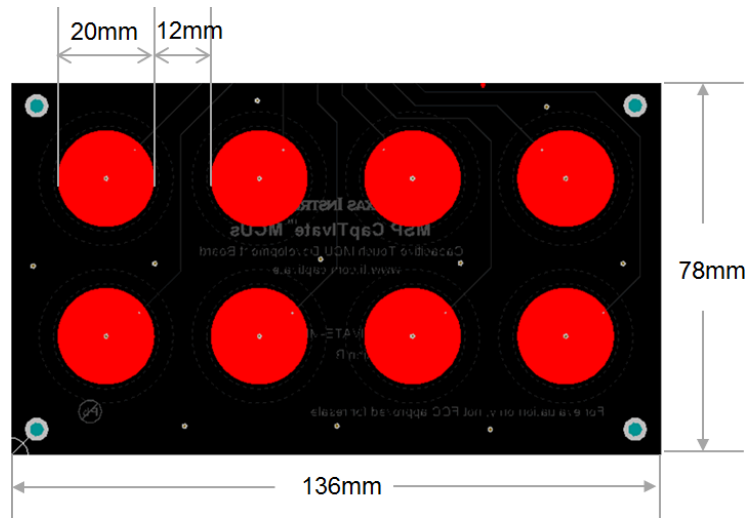

Figure 39. CAPTIVATE-METAL Electrode Design

- Overlay material: Stainless steel 301
- Thickness of overlay: 0.4 mm
- Spacer thickness: 0.1 mm formed by 2 layers of adhesive film
- Spacer hole diameter: 22 mm
- Bracket: 5-mm acrylic
- Adhesive: 3M™ bonding film

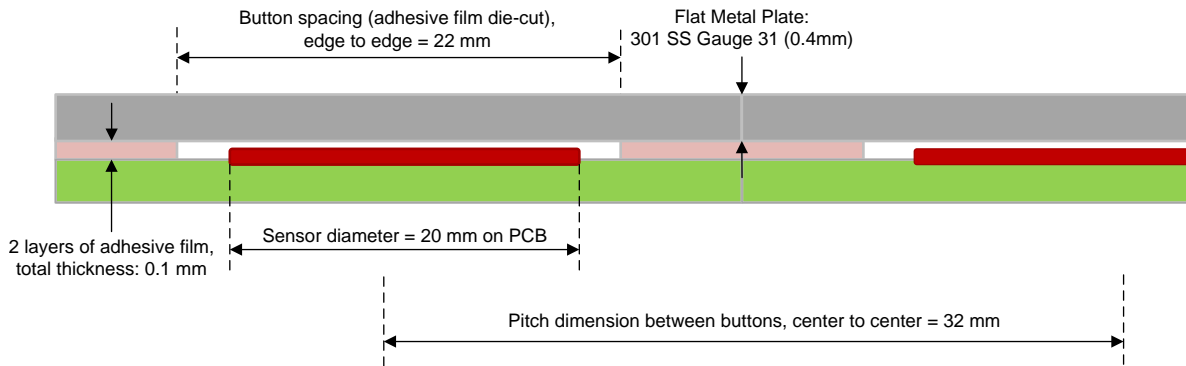

Figure 40. CAPTIVATE-METAL Stackup

7.1.2 Software Design Parameters

- Conversion count = 600
- Conversion gain = 100
- Threshold = 7

7.1.3 Out of Box Experience

The out of box experience includes three demos:

- CAPTIVATE-METAL_Basic
- CAPTIVATE-METAL_Force1
- CAPTIVATE-METAL_Force2

7.1.3.1 CAPTIVATE-METAL_Basic

This mode demonstrates basic function of metal touch. It can simply detect which button is touched and display corresponding number on 7-segment LED. Multi-touch is also supported in this mode, and the sum of all the buttons being touched is displayed on 7-segment LED.

For example, in [Figure 41](#), the number **2** showing on the LED means 2 buttons are touched at the same time (button **7** and button **8**), and the number **15** is the sum of 7 plus 8.



Figure 41. Multi-Touch Demo

7.1.3.2 CAPTIVATE-METAL_ForceTouch1

This mode demonstrate force touch feature of metal touch. In this mode, up to 3 levels of touch force can be detected. And one to three bars on the LED represent a variable force level.

As shown in [Figure 42](#), the number **6** showing on the LED means button 6 is touched. The bars show the touch force level is level 2.



Figure 42. Force Touch Demo 1

7.1.3.3 CAPTIVATE-METAL_ForceTouch2

This mode also demonstrate force touch feature of capacitive metal touch. In this mode, touch force data is real-time displayed in the LED.

As shown in [Figure 43](#), the number **6** showing on the LED means button 6 is touched. The number **125** is the touch force data.



Figure 43. Force Touch Demo 2

8 References

1. [MSP430FR263x, MSP430FR253x Mixed-Signal Microcontrollers](#)
2. [Getting Started With MSP MCUs With CapTIvate™ Technology](#)
3. [Enabling Noise Tolerant Capacitive Touch HMIs with MSP CapTIvate™ Technology](#)
4. [Inductive Sensing Touch-On-Metal Buttons Design Guide](#)

Revision History

NOTE: Page numbers for previous revisions may differ from page numbers in the current version.

Changes from October 26, 2017 to November 1, 2017	Page
• Corrected the link for the Design Center GUI user's guide	17
• Updated Figure 26 , <i>Touch Through Metal Deflection Tool</i>	18
• Updated Figure 40 , <i>CAPTIVATE-METAL Stackup</i>	25

IMPORTANT NOTICE AND DISCLAIMER

TI PROVIDES TECHNICAL AND RELIABILITY DATA (INCLUDING DATASHEETS), DESIGN RESOURCES (INCLUDING REFERENCE DESIGNS), APPLICATION OR OTHER DESIGN ADVICE, WEB TOOLS, SAFETY INFORMATION, AND OTHER RESOURCES "AS IS" AND WITH ALL FAULTS, AND DISCLAIMS ALL WARRANTIES, EXPRESS AND IMPLIED, INCLUDING WITHOUT LIMITATION ANY IMPLIED WARRANTIES OF MERCHANTABILITY, FITNESS FOR A PARTICULAR PURPOSE OR NON-INFRINGEMENT OF THIRD PARTY INTELLECTUAL PROPERTY RIGHTS.

These resources are intended for skilled developers designing with TI products. You are solely responsible for (1) selecting the appropriate TI products for your application, (2) designing, validating and testing your application, and (3) ensuring your application meets applicable standards, and any other safety, security, or other requirements. These resources are subject to change without notice. TI grants you permission to use these resources only for development of an application that uses the TI products described in the resource. Other reproduction and display of these resources is prohibited. No license is granted to any other TI intellectual property right or to any third party intellectual property right. TI disclaims responsibility for, and you will fully indemnify TI and its representatives against, any claims, damages, costs, losses, and liabilities arising out of your use of these resources.

TI's products are provided subject to TI's Terms of Sale (www.ti.com/legal/termsofsale.html) or other applicable terms available either on ti.com or provided in conjunction with such TI products. TI's provision of these resources does not expand or otherwise alter TI's applicable warranties or warranty disclaimers for TI products.

Mailing Address: Texas Instruments, Post Office Box 655303, Dallas, Texas 75265
Copyright © 2019, Texas Instruments Incorporated