

Implementation of One- or Two-Phase Electronic Watt-Hour Meter Using MSP430i20xx

Mekre Mesganaw, Bart Basile

Metering Applications

ABSTRACT

This application report describes the implementation of a low-cost one- or two-phase electronic electricity meter using the Texas Instruments MSP430i20xx metering processor. This application report includes the necessary information with regard to metrology software and hardware procedures for this single-chip implementation.

Source code and other collateral described in this document can be downloaded from http://software-dl.ti.com/dsps/forms/self_cert_export.html?prod_no=slaa637.zip&ref_url=http://software-dl.ti.com/smartgrid/SLAA637.

WARNING

Failure to adhere to these steps and/or not heed the safety requirements at each step may lead to shock, injury, and damage to the hardware.

Contents

1	Introduction	3
2	System Diagrams	3
3	Hardware Implementation	7
4	Software Implementation	9
5	Energy Meter Demo.....	28
6	Results and Calibration.....	38
7	Schematics	54

List of Figures

1	EVM430-i2040 System Block Diagram for Common-Voltage Configuration.....	4
2	EVM430-i2040 System Block Diagram for Neutral-Monitoring Configuration	5
3	EVM430-i2040 System Block Diagram for Two-Phase Configuration	6
4	Simple Capacitive Power Supply for the MSP430 Energy Meter	7
5	Switching-Based Power Supply for the MSP430 Energy Meter	8
6	Analog Front End for Voltage Inputs	8
7	Analog Front End for Current Inputs	9
8	Foreground Process	11
9	Background Process.....	15
10	per_sample_dsp() for Neutral-Monitoring Configuration	16
11	per_sample_dsp() for Common-Voltage Configuration	17
12	per_sample_dsp() for Two-Phase Configuration.....	18
13	Frequency Measurement.....	19

14	Pulse Generation for Energy Indication	21
15	Top View of the Energy Meter EVM	28
16	Top View of the EVM With Components Highlighted.....	29
17	Top View of EVM with Test Setup Connections, Neutral-Monitoring and Common-Voltage.....	31
18	Top View of EVM with Test Setup Connections, Two-Phase	31
19	Front View of the EVM With Test Setup Connections, Common-Voltage	32
20	Front View of the EVM With Test Setup Connections, Neutral-Monitoring	32
21	Front View of the EVM With Test Setup Connections, Two-Phase	32
22	msp430-emeters-i2040 Folder Structure	37
23	Toolkit Project Compilation.....	37
24	Metrology Project Compilation.....	37
25	Application Project Compilation	37
26	GUI Config File Changed to Communicate With Meter	39
27	GUI Startup Window	39
28	Results Window	40
29	Meter Events and Consumption Window	40
30	Calibration Factors Window.....	41
31	Manual Calibration Window	42
32	Calibration Factors Window.....	44
33	Meter Features Window	45
34	Channel A Active Energy Measurement Error, Common-Voltage	46
35	Channel A Reactive Energy Measurement Error, Common-Voltage	46
36	Channel B Active Energy Measurement Error, Common-Voltage	48
37	Channel B Reactive Energy Measurement Error, Common-Voltage	48
38	Channel C Active Energy Measurement Error, Common-Voltage	50
39	Channel C Reactive Energy Measurement Error, Common-Voltage.....	50
40	Cumulative Phase Active Energy Measurement Error, Two-Phase	52
41	Cumulative Phase Reactive Energy Measurement Error, Two-Phase	52
42	Schematics, 1 of 3	55
43	Schematics, 2 of 3	56
44	Schematics, 3 of 3	57

List of Tables

1	Header Names and Jumper Settings on the EVM430-i2040	33
2	Channel A Energy Measurement Error, Common-Voltage	47
3	Channel B Energy Measurement Error, Common-Voltage	49
4	Channel C Energy Measurement Error, Common-Voltage	51
5	Cumulative Phase Energy Measurement Error, Two-Phase	53

1 Introduction

The MSP430i20xx devices belong to the 16-bit MSP430i2xx platform. These devices find their application in power and energy measurement and have the necessary architecture to support it. The MSP430i20xx devices have an internal 16.384-MHz DCO, which is used to generate system clocks without an external crystal.

The MSP430i204x derivatives of the MSP430i20xx devices have four independent 24-bit sigma-delta ($\Sigma\Delta$) analog-to-digital converters (ADC) based on a second-order sigma-delta architecture that supports differential inputs. These sigma-delta ADCs (SD24) operate independently, are capable of 24-bit results, and can be grouped together for simultaneous sampling of voltages and currents on the same trigger. In addition, each converter also has an integrated gain stage for amplification of low-output current sensors.

The MSP430i20xx devices also have 16-bit x 16-bit hardware multiplier that can be used to further accelerate math intensive operations during metrology computations. The programmable software for the MSP430i204x supports calculation of various parameters for three configurations: common-voltage measurement (one voltage and three currents), neutral-monitoring measurement (one voltage and two currents), and two-phase measurement (two voltages and two currents). The key parameters calculated during measurements are: RMS current and voltage, active and reactive power and energies, power factor, and frequency.

This application note has complete metrology source code provided as a zip file available at http://software-dl.ti.com/dsps/forms/self_cert_export.html?prod_no=slaa637.zip&ref_url=http://software-dl.ti.com/smartgrid/SLAA637.

2 System Diagrams

The reference EVM ([EVM430-i2040](#)) supports three configurations: common-voltage measurement (one voltage and three currents), neutral-monitoring measurement (one voltage and two currents), and two-phase measurement (two voltages and two currents). [Figure 1](#) through [Figure 3](#) show the high-level system block diagrams of this EVM for each of these three configurations. As seen in the system diagrams, the EVM is divided into a metrology portion that has the MSP430i204x and the application portion that has the MSP430F663x. In this scheme, the MSP430i204x is a slave metrology processor and the MSP430F663x is the host or application processor. Isolated interprocessor communication between the MSP430i204x and the MSP430F663x is possible using the EVM's digital isolators that are between both chips' SPI lines.

In each configuration, current sensors are connected to each of the current channels and a simple voltage divider is used for corresponding voltages. The CT has an associated burden resistor that must be connected at all times to protect the measuring device. The choice of the CT and the burden resistor is done based on the manufacturer and current range required for energy measurements. The choice of voltage divider resistors for the voltage channel is selected to make sure that the mains voltage is divided down to the normal input ranges that are valid for the MSP430™ SD24. Refer to the *MSP430i2xx Family User's Guide* ([SLAU335](#)) and the MSP430i20xx data sheet ([SLAS887](#)) for these limits.

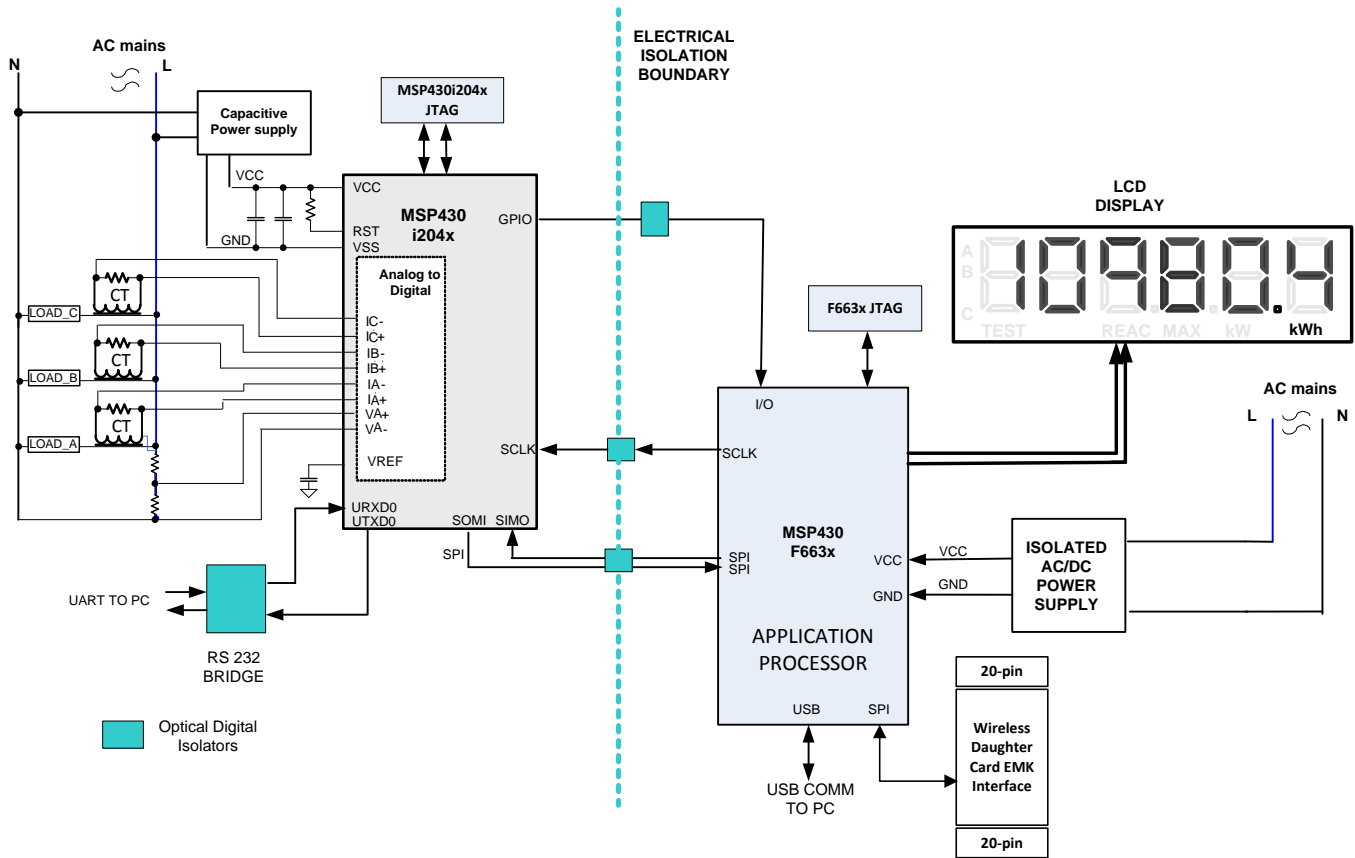

Figure 1. EVM430-i2040 System Block Diagram for Common-Voltage Configuration

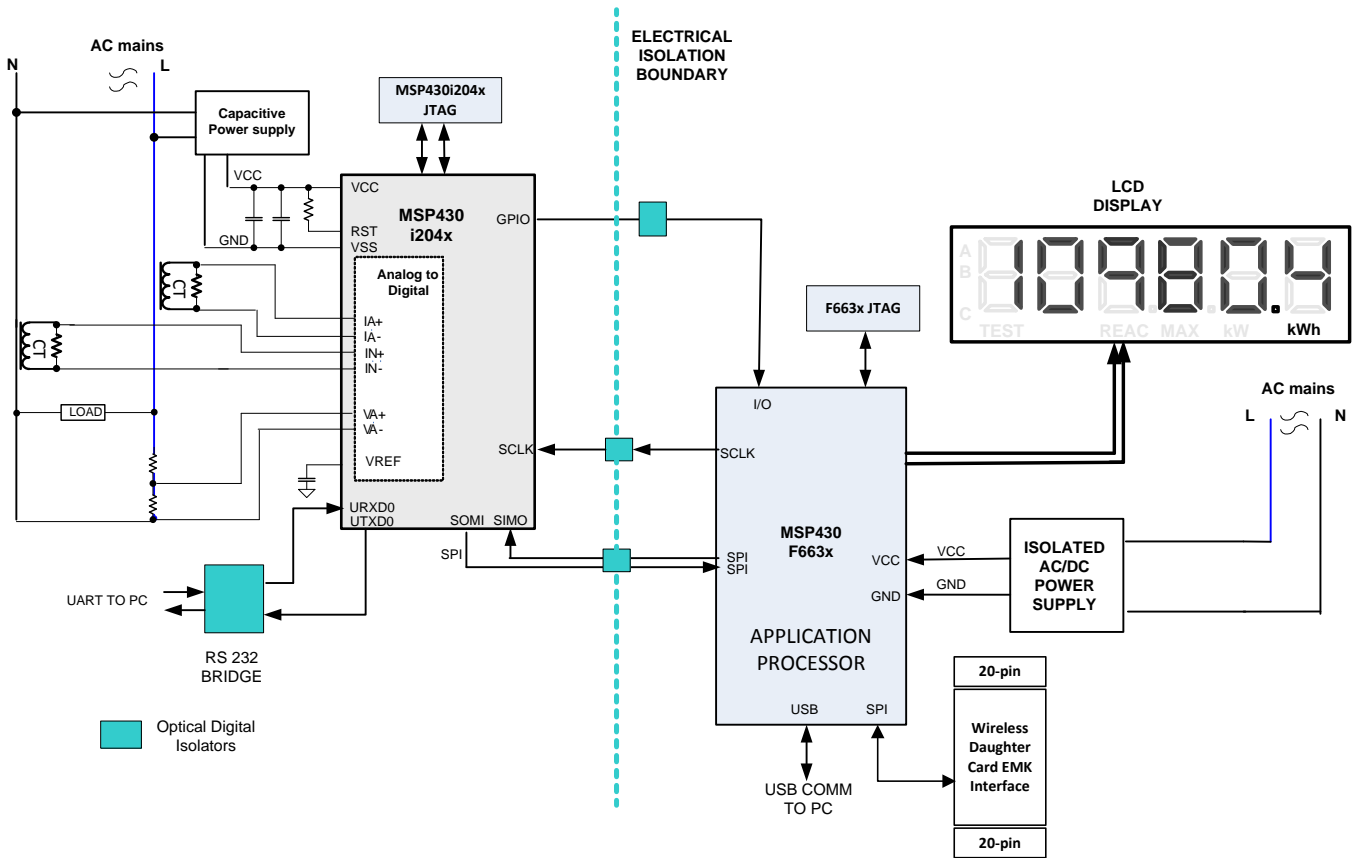

Figure 2. EVM430-i2040 System Block Diagram for Neutral-Monitoring Configuration

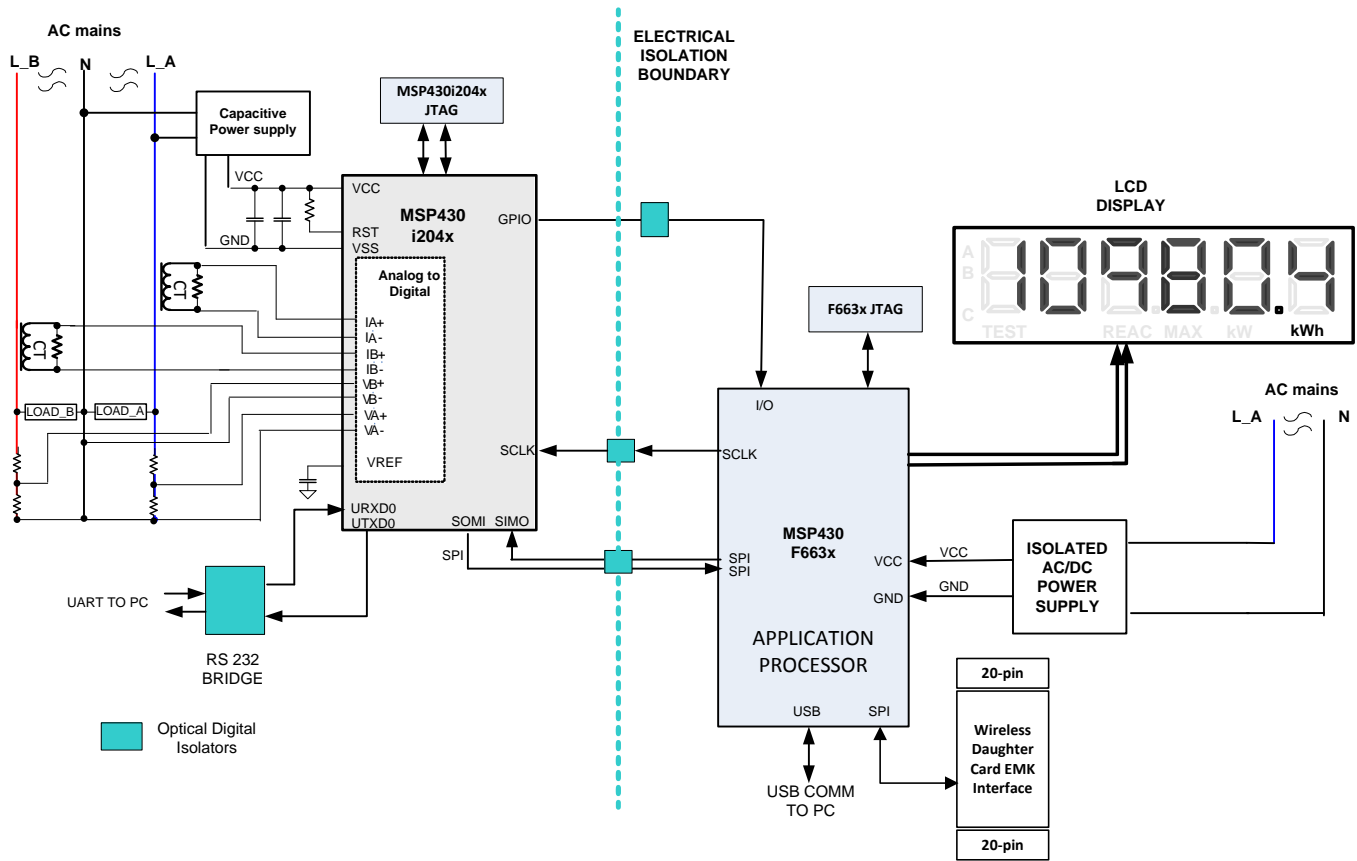

Figure 3. EVM430-i2040 System Block Diagram for Two-Phase Configuration

3 Hardware Implementation

This section describes the front-end passive components and other components that are required for the design of a working meter using the MSP430i204x.

3.1 Power Supply

The MSP430 microcontrollers support a number of low-power modes in addition to low-power consumption during active (measurement) mode when the CPU and other peripherals are active. Because an energy meter is always interfaced to the ac mains, the dc supply required for the measuring element (MSP430i204x) can be easily derived using an ac-to-dc conversion mechanism.

3.1.1 Resistor Capacitor (RC) Power Supply

Figure 4 shows a capacitor power supply that provides a single output voltage of 3.3 V directly from the mains of 120/230 V RMS ac at 50/60 Hz. In Figure 4, appropriate values of resistor R54 and capacitor C60 are chosen based on the required output current drive of the power supply.

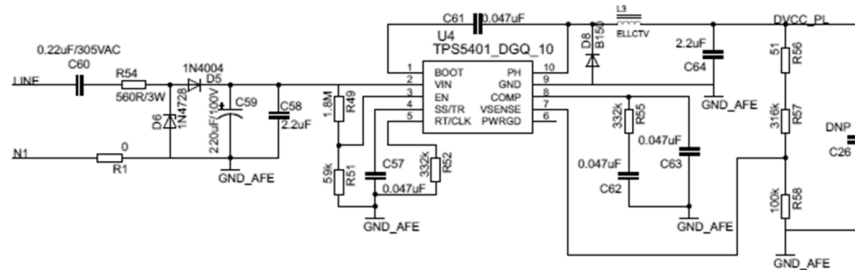

Figure 4. Simple Capacitive Power Supply for the MSP430 Energy Meter

As shown in Figure 4, voltage from the mains is directly fed to a RC-based circuit followed by a rectification circuit to provide a dc voltage for the operation of the MSP430 microcontroller. This dc voltage is regulated to 3.3 V for full-speed operation of the MSP430 microcontroller. The design equations for the power supply are given in the application report *Improved Load Current Capability for Cap-Drop Off-Line Power Supply for E-Meter* (SLVA491). If even higher output drive is required, the same circuitry can be used followed by an NPN output buffer. Another option would be to replace RC circuitry with a transformer-based or switching-based power supply, as described in Section 3.1.2.

3.1.2 Switching Power Supply

When high current drive is required to drive RF transceivers, a simple capacitive power supply cannot provide enough peak current. Hence, a switching-based power supply is required. A separate power supply module on the board can be used to provide 3.3 V dc from the ac mains of 110 V to 230 V ac. Figure 5 shows the use of an SMPS module to provide a 3.3-V rail with increased current drive. This module can be used on the EVM430-i2040 to provide an isolated voltage to drive only the MSP430F663x and its associated interfaces.

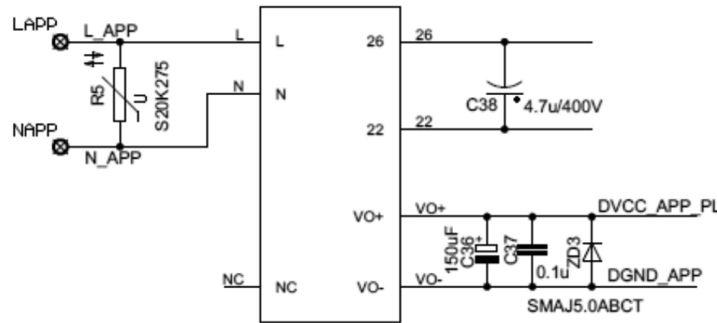

Figure 5. Switching-Based Power Supply for the MSP430 Energy Meter

3.2 Analog Inputs

The MSP430i204x's analog front-end, which consists of the $\Sigma\Delta$ ADC, is differential and requires that the input voltages at the pins do not exceed ± 928 mV (gain = 1). To meet this specification, the current and voltage inputs need to be scaled down. In addition, the SD24 allows a maximum negative voltage of -1 V. Therefore, the ac current signal from mains can be directly interfaced without the need for level shifters. This section describes the analog front end used for the voltage and current channels.

3.2.1 Voltage Inputs

The voltage from the mains is usually 230 V or 120 V and must be scaled down within 928 mV. The analog front end for voltage consists of spike protection varistors followed by a voltage divider network, and a RC low-pass filter that acts like an anti-alias filter. For the EVM430-i2040, footprints for suppressant inductors are also available. These inductor footprints are shown in Figure 6 as L4 and L6 and, by default, are populated with 0- Ω resistors.

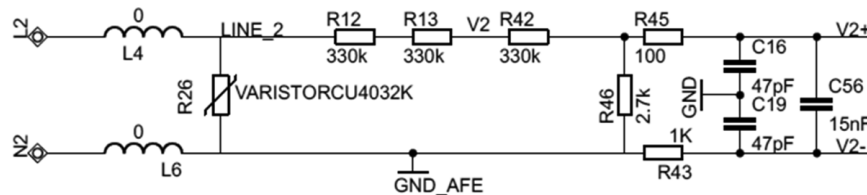

Figure 6. Analog Front End for Voltage Inputs

Figure 6 shows the analog front end for the voltage inputs for a mains voltage of 230 V. In this circuitry, the voltage is brought down to approximately 626 mV RMS, which is 885 mV peak, and fed to the positive input of the converter. It is important to note that the anti-alias resistors on the positive and negative sides are different because the input impedance to the positive terminal is much higher; therefore, a lower value resistor is used for the antialias filter. If this is not maintained, a relatively large phase shift would result between voltage and current samples.

3.2.2 Current Inputs

The analog front-end for current inputs is slightly different from the analog front end for the voltage inputs. Figure 7 shows the analog front end used for a current channel.

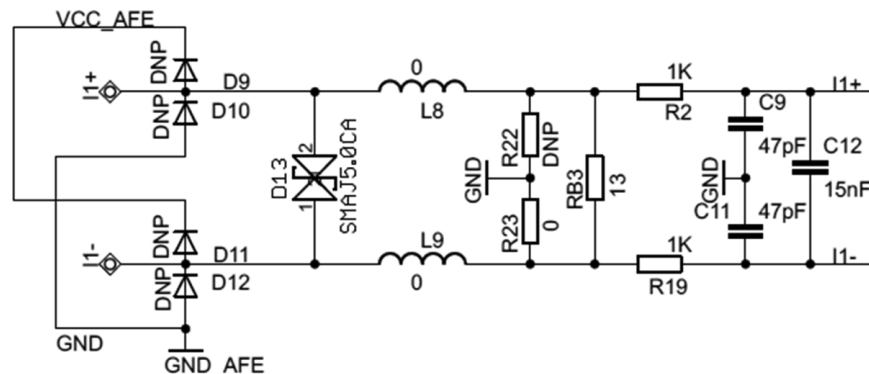

Figure 7. Analog Front End for Current Inputs

In Figure 7, resistor RB3 is the burden resistor that is selected based on the current range used and the turns ratio specification of the CT (CTs with a turns ratio of 2000:1 are used for this design). The value of the burden resistor for this design is 13 Ω . The antialiasing circuitry, consisting of resistors and capacitors, follows the burden resistor. Based on this EVM's maximum current of 100 A, CT turns ratio of 2000:1, and burden resistor of 13 Ω , the input signal to the converter is a fully differential input with a voltage swing of ± 919 mV maximum when the maximum current rating of the meter (100 A) is applied.

For the EVM430-i2040, footprints for suppressant inductors are also available. These inductor footprints are shown as L8 and L9 and by default are populated with 0- Ω resistors.

3.3 External Resistor and Oscillator For Clock

The MSP430i20xx internal DCO supports two modes of operation. It can operate with an internal resistor or an external resistor that is connected to ROSC pin of the device. For achieving Class 1% target accuracy, the external resistor option must be used. In this option, a 20-k Ω ± 50 -ppm resistor with 0.1% tolerance is recommended. This resistor is populated on this EVM, and the software is configured to use this resistor. If there is an error with the external resistor, the MSP430i204x automatically switches to internal resistor mode.

In addition to sourcing the clocks from the internal DCO, the MSP430i204x can also run from a 16.384-MHz external clock. In the EVM430-i2040, although an external clock is not used or needed, a footprint for a clock generator is provided to support this option.

4 Software Implementation

The software associated with this application note has software for the MSP430i2041 metrology processor. For this first revision of this software, no software for the MSP430F6638 host processor is provided. In addition, note there are three configurations that can be chosen in software: neutral monitoring, two phase, and common voltage. Note that if a particular configuration is selected, the hardware must be set to support it, which is done by the configuration select jumper pads. Similarly, if the hardware is configured for a particular setting, the software must also be set for that same configuration.

Regardless of which configuration is selected, the software has three projects: one for mathematical routines, another primarily for metrology (including calculation of voltage, current, and power), and an application wrapper that deals mainly with application-processor functionality (for example, communication, RTC, and LCD display). The separation of the metrology and application processor enables easy porting from TI's EVM to an alternative MSP430i204x-based board with minimal changes to the metrology code. Also, if it is desired to get the readings of the metrology parameters to make any further additions to the code, the "metrology-readings.h" file could be used to view the different functions that can be called from the application project to retrieve the newest set of metrology parameters. Refer to metrology-types.h to see the associated units of these returned metrology parameters.

In the following sections, the software is described. [Section 4.1](#) describes the configuration of various peripherals of the MSP430 microcontroller. The entire metrology software is then described as two major processes: the foreground process (see [Section 4.2](#)) and the background process (see [Section 4.3](#)).

4.1 Peripherals Setup

The major peripherals for this application are the 24-bit sigma delta (SD24) ADC, the clock system, the timer, and the watchdog timer (WDT).

4.1.1 Start-Up Code for Device Security and Peripheral Calibration

Device-specific calibration values are stored in each MSP430i20xx device's information (INFO) memory. These values affect items such as clock accuracy, SD24 operation, and reference voltage operation. For proper functionality of this device, these values need to be loaded into the proper calibration and trim registers, as described in the *TLV and Start-Up Code* chapter of the *MSP430i2xx Family User's Guide* ([SLAU335](#)). In addition, a decision whether to secure or unsecure the MSP430i204x must be made in the first 64 MCLK cycles after RESET. Both of these operations are accomplished in the `low_level_init` function (in `low_level_init.c`), which runs before even the main function is called.

CAUTION

Because the device-specific peripheral calibration is stored in INFO memory, make sure not to change the project settings to erase INFO memory, because it would erase these values. Also note that meter calibration data is stored in the same segment as the peripheral calibration information. As a result, care must be taken to not delete the peripheral calibration values if performing meter calibration by using custom-written code that is outside the normal code of the energy library.

4.1.2 SD24 Setup

The MSP430i204x devices have four sigma-delta data converters, which are used to measure the voltage and currents in the system. For the MSP430i20xx, the clock to the SD24 ADCs (f_M) is fixed at 1.024000 MHz. In the software, an OSR of 256 is chosen, which results in a sampling frequency of 4.000 ksp/s for the converters. At every sampling instance, the SD24 converters are configured to generate regular interrupts.

The following are the $\Sigma\Delta$ channel associations in software for the neutral-monitoring configuration:

- A0.0+ and A0.0- → Voltage V_A
- A1.0+ and A1.0- → Not Used
- A2.0+ and A2.0- → Current I_A (Live)
- A3.0+ and A3.0- → Current I_N (Neutral)

For the two-phase configuration, the following channel associations in software are used:

- A0.0+ and A0.0- → Voltage V_A
- A1.0+ and A1.0- → Voltage V_B
- A2.0+ and A2.0- → Current I_A
- A3.0+ and A3.0- → Current I_B

For the common-voltage configuration, the following channel associations in software are used:

- A0.0+ and A0.0- → Voltage V_A
- A1.0+ and A1.0- → Current I_A
- A2.0+ and A2.0- → Current I_B
- A3.0+ and A3.0- → Current I_C

4.2 Foreground Process

The foreground process includes the initial setup of the MSP430 hardware and software immediately after a device RESET. [Figure 8](#) shows the flowchart for this process.

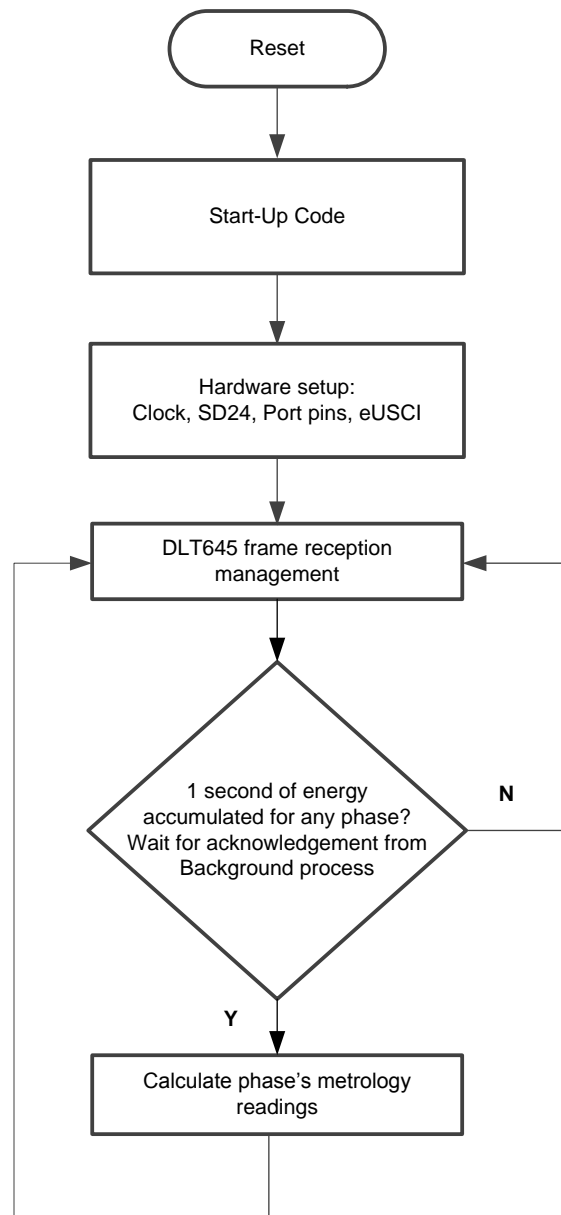

Figure 8. Foreground Process

The initialization routines involve the setup of the ADC, the clock system, the general-purpose input/output (port) pins, and the USCI_A0 for UART functionality. After the hardware is setup, any received frames from the GUI are processed. Subsequently, the foreground process checks whether the background process has notified it to calculate new metering parameters. This notification is done through the assertion of the PHASE_STATUS_NEW_LOG status flag whenever a frame of data is available for processing. The data frame consists of the processed dot products that were accumulated for one second in the background process. This is equivalent to accumulation of 50 or 60 cycles of data synchronized to the incoming voltage signal. In addition, a sample counter keeps track of how many samples have been accumulated over this frame period. This count can vary as the software synchronizes with the incoming mains frequency.

The processed dot products include the VRMS, IRMS, active power, and reactive power. These dot products are used by the foreground process to calculate the corresponding metrology readings in real-world units. Processed voltage dot products are accumulated in 48-bit registers. In contrast, processed current dot products, active energy dot products, and reactive energy dot products are accumulated in separate 64-bit registers to further process and obtain the RMS and mean values. Using the foreground's calculated values of active and reactive power, the apparent power is calculated. The frequency (in Hertz) and power factor are also calculated using parameters calculated by the background process using the formulas in [Section 4.2.1](#).

4.2.1 Computation Formulas

This section briefly describes the formulas used for the voltage, current, and energy calculations.

4.2.1.1 RMS Voltage and Current

As described in the previous sections, voltage and current samples are obtained from the $\Sigma\Delta$ converters at a sampling rate of 4000 Hz. All of the samples that are taken in 1 second are kept and used to obtain the RMS values for voltage and current for each phase. The RMS values are obtained by the following formulas:

$$V_{\text{RMS,ph}} = K_{v,\text{ph}} \times \sqrt{\frac{\sum_{n=1}^{\text{Sample count}} v_{\text{ph}}(n) \times v_{\text{ph}}(n)}{\text{Sample count}} - v_{\text{offset,ph}}}$$

$$I_{\text{RMS,ph}} = K_{i,\text{ph}} \times \sqrt{\frac{\sum_{n=1}^{\text{Sample count}} i_{\text{ph}}(n) \times i_{\text{ph}}(n)}{\text{Sample count}} - i_{\text{offset,ph}}}$$

where

- ph = The Voltage-Current association whose parameters are being calculated. For the neutral-monitoring and two-phase configuration, that is Phase A (= 1) and Phase B (= 2). For the common-voltage configuration, that is Current Channel A (= 1), Current Channel B (= 2), and Current Channel (= 3).
- $v_{\text{ph}}(n)$ = Voltage sample at a sample instant n
- $v_{\text{offset,ph}}$ = Offset used to subtract effects of the additive white Gaussian noise from the voltage converter
- $i_{\text{ph}}(n)$ = Each current sample at a sample instant n
- $i_{\text{offset,ph}}$ = Offset used to subtract effects of the additive white Gaussian noise from the current converter
- Sample count = Number of samples in one second
- $K_{v,\text{ph}}$ = Scaling factor for voltage
- $K_{i,\text{ph}}$ = Scaling factor for each current

(1)

4.2.1.2 Power and Energy

Power and energy are calculated for one frame's worth of active and reactive energy samples. These samples are phase corrected and passed on to the foreground process, which uses the number of samples (sample count) to calculate channel/phase active and reactive powers by the formulas in [Equation 2](#).

$$P_{ACT,ph} = K_{ACT,ph} \frac{\sum_{n=1}^{\text{Sample count}} v(n) \times i_{ph}(n)}{\text{Sample count}}$$

$$P_{REACT,ph} = K_{REACT,ph} \frac{\sum_{n=1}^{\text{Sample count}} v_{90}(n) \times i_{ph}(n)}{\text{Sample count}}$$

where

- $v_{90,ph}(n)$ = Voltage sample at a sample instant n shifted by 90° , and
 - $K_{ACT,ph}$ = Scaling factor for active power
 - $K_{REACT,ph}$ = Scaling factor for reactive power
- (2)

For reactive power, the 90° phase shift approach is used for two reasons:

- It allows accurate measurement of the reactive power for very small currents.
- It conforms to the international specified measurement method.

The calculated mains frequency is used to calculate the 90° shifted voltage sample. Because the frequency of the mains varies, it is important to first measure the mains frequency accurately to phase shift the voltage samples accordingly (see [Section 4.3.3](#)).

To get an exact 90° phase shift, interpolation is used between two samples. For these two samples, a voltage sample slightly more than 90° before the current sample and a voltage sample slightly less than 90° before the current sample are used. The application's phase shift implementation consists of an integer part and a fractional part. The integer part is realized by providing an N samples delay. The fractional part is realized by a one-tap FIR filter. In the software, a lookup table provides the filter coefficients that are used to create the fractional delays.

After calculating the active and reactive power the apparent power is calculated by the following formula:

$$P_{APP,ph} = \sqrt{P_{ACT,ph}^2 + P_{REACT,ph}^2}$$
(3)

In addition to calculating the per-phase active, reactive, and apparent powers, the cumulative sum of these parameters are calculated for the two-phase configuration. These cumulative parameters are calculated by the following equations:

$$P_{ACT,Cumulative} = \sum_{ph=1}^2 P_{ACT,ph}$$

$$P_{REACT,Cumulative} = \sum_{ph=1}^2 P_{REACT,ph}$$

$$P_{APP,Cumulative} = \sum_{ph=1}^2 P_{APP,ph}$$
(4)

For each of the three configurations, the calculated powers for each phase are then converted to energy by the following equations:

$$E_{ACT,ph} = P_{ACT,ph} \times \text{Samplecount}$$

$$E_{REACT,ph} = P_{REACT,ph} \times \text{Samplecount}$$

$$E_{APP,ph} = P_{APP,ph} \times \text{Samplecount}$$
(5)

From there, for the two-phase configuration, they are also accumulated to calculate the cumulative energies, as shown by the following equations:

$$\begin{aligned}
 E_{\text{ACT, Cumulative}} &= \sum_{\text{ph}=1}^2 E_{\text{ACT,ph}} \\
 E_{\text{REACT, Cumulative}} &= \sum_{\text{ph}=1}^2 E_{\text{REACT,ph}} \\
 E_{\text{APP, Cumulative}} &= \sum_{\text{ph}=1}^2 E_{\text{APP,ph}}
 \end{aligned} \tag{6}$$

The calculated energies are then accumulated into buffers that store the total amount of energy consumed since meter reset. Note that these energies are different from the working variables used to accumulate energy for outputting energy pulses. Also, there is one set of buffers for each voltage-current association, and if applicable, one set of buffers for the cumulative of the phases. Within each set of buffers, the following energies are accumulated:

- Active import energy (active energy when active energy ≥ 0)
- Active export energy (active energy when active energy < 0)
- Reactive Quad I energy (reactive energy when reactive energy ≥ 0 and active power ≥ 0 ; inductive load)
- Reactive Quad II energy (reactive energy when reactive energy ≥ 0 and active power < 0 ; capacitive generator)
- Reactive Quad III energy (reactive energy when reactive energy < 0 and active power < 0 ; inductive generator)
- Reactive Quad IV energy (reactive energy when reactive energy < 0 and active power ≥ 0 ; capacitive load)
- Apparent import energy (apparent energy when active energy ≥ 0)
- Apparent export energy (apparent energy when active energy < 0)

4.2.1.3 Frequency (Hz)

The background process calculates the frequency in terms of samples per mains cycle. The foreground process then converts this to Hertz by [Equation 7](#).

$$\text{Frequency (Hz)} = \frac{\text{Sampling Rate (samples/ second)}}{\text{Frequency (samples/ cycle)}} \tag{7}$$

4.2.1.4 Power Factor

After the active power and apparent power have been calculated, the absolute value of the power factor is calculated. In the meter's internal representation of power factor, a positive power factor corresponds to a capacitive load or generator and a negative power factor corresponds to an inductive load or generator. The sign of the internal representation of power factor is determined based on the sign of the active and reactive power. Therefore, the internal representation of power factor is calculated by [Equation 8](#):

$$\text{Internal Representation of Power Factor} = \begin{cases} \frac{|P_{\text{Act}}|}{P_{\text{Apparent}}}, & \text{if capacitive load/generator} \\ -\frac{|P_{\text{Act}}|}{P_{\text{Apparent}}}, & \text{if inductive load/generator} \end{cases} \tag{8}$$

4.3 Background Process

The background function deals mainly with timing critical events in software. It uses the SD24 interrupt as a trigger to collect voltage and current samples. The SD24 interrupt is generated when a new voltage sample is ready. When the voltage sample is obtained, sample processing is done on the previously obtained voltage and current samples. This sample processing is done by the `per_sample_dsp()` function. After sample processing, the background process uses the `per_sample_energy_pulse_processing()` for the calculation and output of energy-proportional pulses. [Figure 9](#) shows the flowchart for this process.

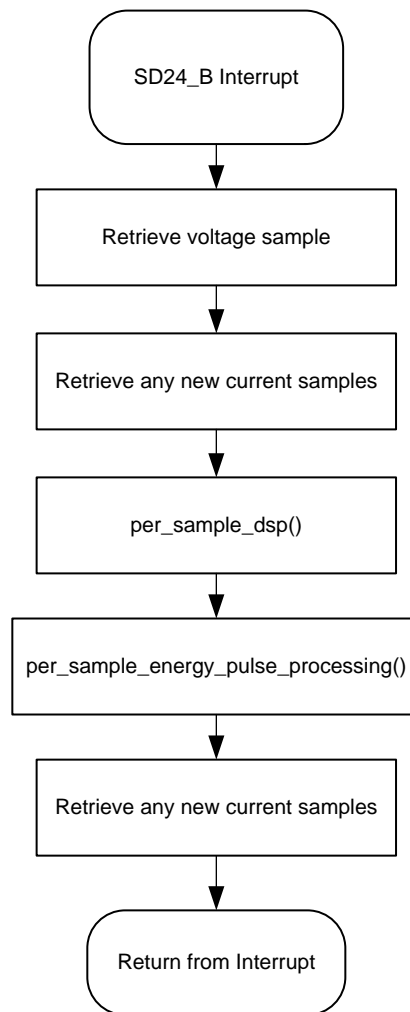

Figure 9. Background Process

4.3.1 per_sample_dsp()

The flowchart for the per_sample_dsp function is shown in [Figure 10](#), [Figure 11](#), and [Figure 12](#). In this function, the per_sample_dsp function is used to calculate intermediate dot product results that are fed into the foreground process for the calculation of metrology readings. Because 16-bit voltage samples are used, the voltage samples are further processed and accumulated in dedicated 48-bit registers. In contrast, because 24-bit current samples are used, the current samples are processed and accumulated in dedicated 64-bit registers. Per-phase active power and reactive power are also accumulated in 64-bit registers.

After sufficient samples (approximately one second's worth) have been accumulated, then the foreground function is triggered to calculate the final values of VRMS, IRMS, active, reactive, and apparent powers, active, reactive, and apparent energy, frequency, and power factor. In the software, there are two sets of dot products: at any given time, one is used by the foreground for calculation and the other used as the working set by the background. After the background process has sufficient samples, it swaps the two dot products so that the foreground uses the newly acquired dot products that the background process just calculated and the background process uses a new empty set to calculate the next set of dot products.

Whenever there is a leading-edge zero-crossing (- to + voltage transition) on a voltage channel, the `per_sample_dsp` function is also responsible for updating the corresponding phase's frequency (in samples/cycle) and voltage sag and swell conditions. For the sag conditions, whenever the RMS voltage is below a certain user-defined threshold percentage, the number of mains cycles where this condition persists is logged as the sag duration. The number of periods in time where there was a sag condition is logged as the sag events count. Note that the sag duration corresponds to the total number of cycles in a sag condition since reset, and is therefore, not cleared for every sag event. Also, when the RMS voltage is above a certain threshold percentage, swell events and duration are logged in a similar way.

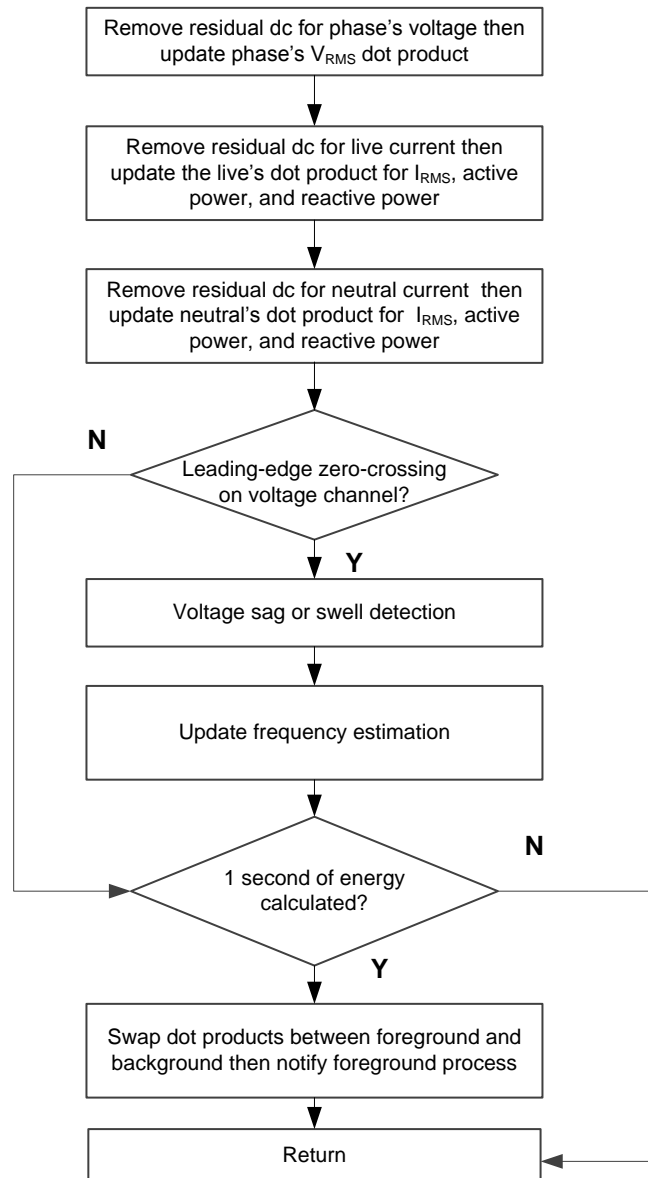

Figure 10. `per_sample_dsp()` for Neutral-Monitoring Configuration

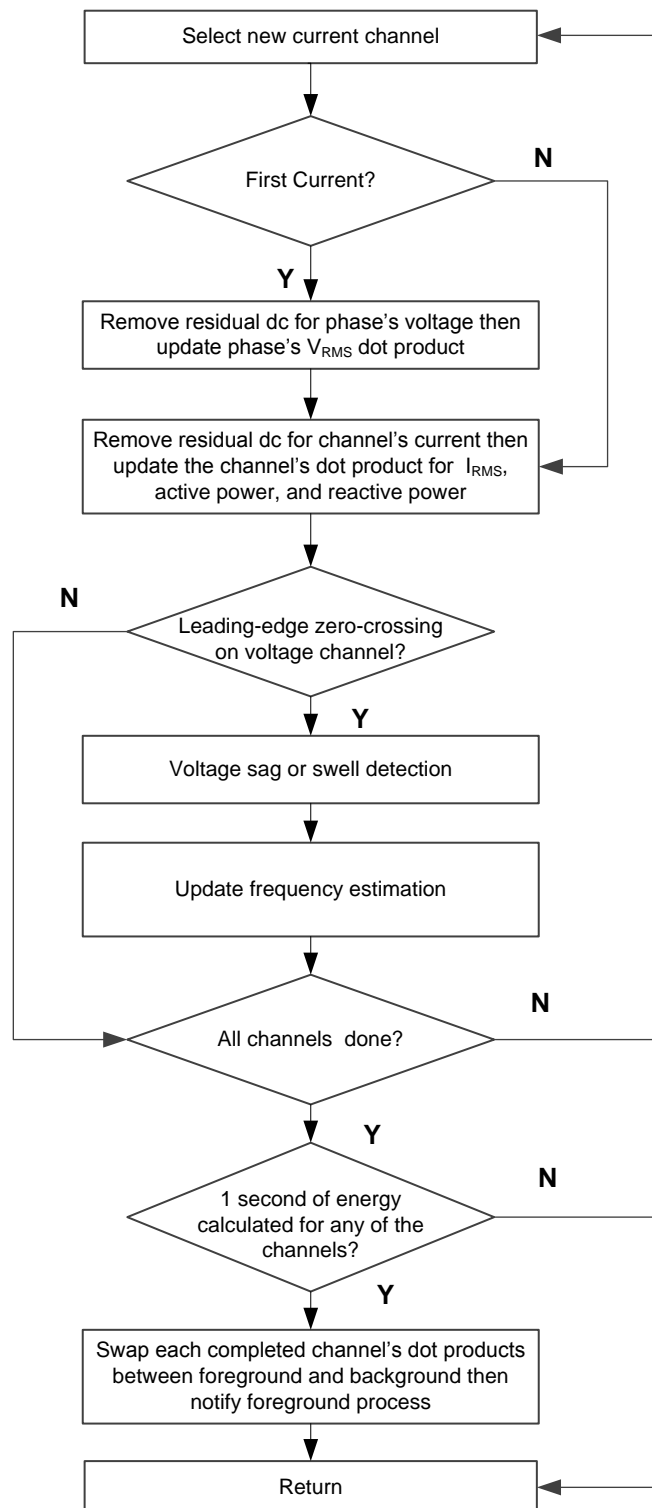

Figure 11. per_sample_dsp() for Common-Voltage Configuration

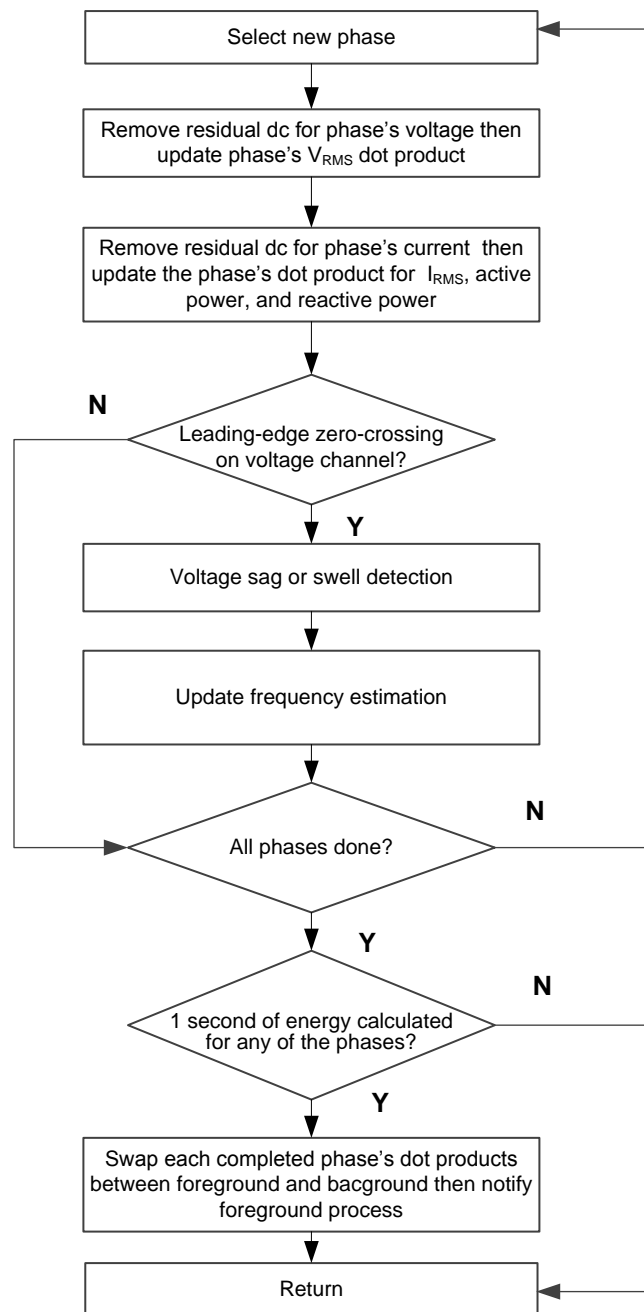

Figure 12. per_sample_dsp() for Two-Phase Configuration

The following sections describe the various elements of electricity measurement in the per_sample_dsp function.

4.3.1.1 Voltage and Current Signals

The output of each $\Sigma\Delta$ converter is a signed integer and any stray dc or offset value on these converters are removed using a dc tracking filter. Separate dc estimates for all voltages and currents are obtained using the filter and voltage and current samples, respectively. These estimates are then subtracted from each voltage and current sample.

The resulting instantaneous voltage and current samples are used to generate the following intermediate dot product results:

- Accumulated squared values of voltages and currents, which is used for VRMS and IRMS calculations, respectively.
- Accumulated energy samples to calculate active energies.
- Accumulated energy samples using current and 90° phase shifted voltage to calculate reactive energies.

These accumulated values are processed by the foreground process.

4.3.1.2 Frequency Measurement and Cycle Tracking

The instantaneous voltage of each phase is accumulated in 48-bit registers. In contrast, the instantaneous current, active power, and reactive power are accumulated in 64-bit registers. A cycle tracking counter and sample counter keep track of the number of samples accumulated. When approximately one second's worth of samples have been accumulated, the background process switches the foreground and background then notifies the foreground process to produce the average results such as RMS and power values. Cycle boundaries are used to trigger the foreground averaging process because it produces very stable results.

For frequency measurements, a straight line interpolation is used between the zero crossing voltage samples. [Figure 13](#) shows the samples near a zero cross and the process of linear interpolation.

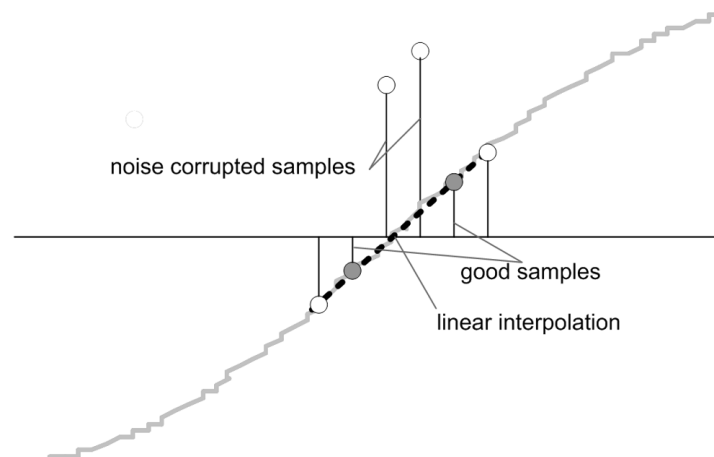

Figure 13. Frequency Measurement

Because noise spikes can also cause errors, the application uses a rate of change check to filter out the possible erroneous signals and make sure that the two points that are interpolated from are genuine zero crossing points. For example, with two negative samples, a noise spike can make one of them positive, and therefore, make the negative and positive pair look as if there is a zero crossing.

The resultant cycle-to-cycle timing goes through a weak low-pass filter to further smooth out cycle-to-cycle variations. This results in a stable and accurate frequency measurement that is tolerant of noise.

4.3.2 LED Pulse Generation (per_sample_energy_pulse_processing)

In electricity meters, the active energy consumed is normally measured in fraction of kilowatt-hour (kWh) pulses. This information can be used to calibrate any meter for accurate measurement. Typically, the measuring element (the MSP430 microcontroller) is responsible to generate pulses proportional to the energy consumed. To serve both these tasks efficiently, pulse generation must be accurate with relatively little jitter. Although, time jitters are not an indication of bad accuracy, they give a negative indication on the overall accuracy of the meter. Hence the jitter must be averaged out.

This application uses average power to generate these energy pulses. The average power (calculated by the foreground process) is accumulated every SD24 interrupt, thereby spreading the accumulated energy from the previous 1 second time frame evenly for each interrupt in the current 1 second time frame. This is equivalent to converting it to energy. When the accumulated energy crosses a threshold, a pulse is generated. The amount of energy above this threshold is kept and new energy value is added on top of it in the next interrupt cycle. Because the average power tends to be a stable value, this way of generating energy pulses are very steady and free of jitter.

The threshold determines the energy "tick" specified by meter manufacturers and is a constant. It is usually defined in pulses per kWh or just in kWh. One pulse is generated for every energy "tick". For example, in this application, the number of pulses generated per kWh is set to 6400 for active and reactive energies. The energy "tick" in this case is 1 kWh/6400. Energy pulses are generated and available on a header and also via LEDs on the board. General-purpose I/O (port) pins are used to produce the pulses.

In the EVM, the LEDs that are labeled LED_ACT and LED_REACT correspond to the aggregate active energy consumption and aggregate reactive energy consumption, respectively, when using the two-phase configuration. For the neutral-monitoring case, LED_ACT and LED_REACT corresponds to the active and reactive energy for the energy measured on the live wire. When using the common-voltage configuration, these LEDs correspond to the active and reactive energy of a particular channel that is selected from software. The number of pulses per kWh and each pulse duration can be configured in software.

[Figure 14](#) shows the flow diagram for pulse generation. This flow diagram is valid for active and reactive energy.

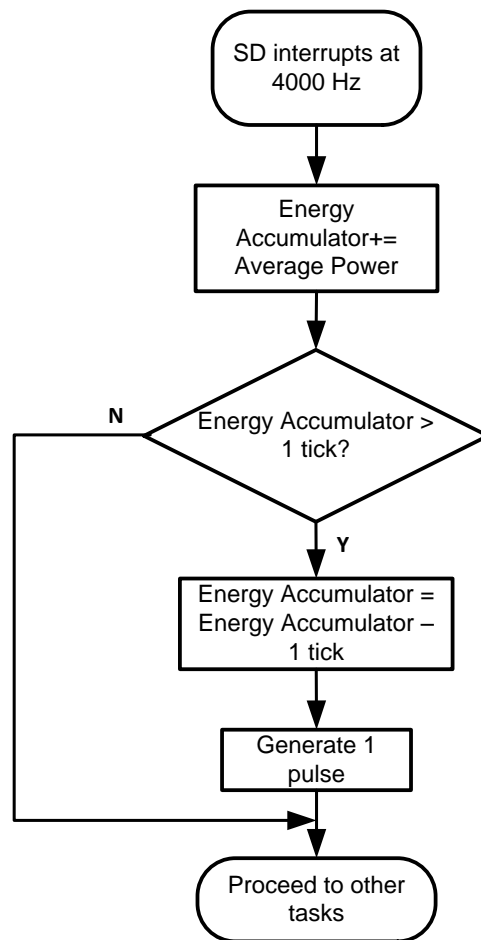

Figure 14. Pulse Generation for Energy Indication

The average power is in units of 0.001 W and the 1-kWh threshold is defined as:

$$1\text{-kWh threshold} = (1 / 0.001) \times 1 \text{ kW} \times (\text{number of interrupts per second}) \times (\text{number of seconds in one hour}) = 1000000 \times 4000 \times 3600 = \text{D18C2E28000h}$$

4.3.3 Phase Compensation

When a current transformer (CT) is used as a sensor, it introduces additional phase shift on the current signals. Also, the voltage and current input circuit's passive components may introduce additional phase shift. The relative phase shift between voltage and current samples must be compensated to ensure accurate measurements. The $\Sigma\Delta$ converters have programmable delay registers (SD24PREx) that can be applied to any current or voltage channel. This built-in feature (PRELOAD) is used to provide the phase compensation required.

The fractional delay resolution of the preload register is a function of input frequency (f_{IN}), OSR, and the sampling frequency (f_S).

$$\text{Delay resolution}_{\text{Deg}} = \frac{360^\circ \times f_{IN}}{\text{OSR} \times f_S} = \frac{360^\circ \times f_{IN}}{f_M} \tag{9}$$

In this application, for input frequency of 50 Hz, OSR of 256, and sampling frequency of 4000, the resolution for every bit in the preload register is approximately 0.02° with a maximum of 4.48° (maximum of 255 steps). When using CTs that provide a larger phase shift than this maximum, sample delays along with fractional delay must be provided. This phase compensation can also be modified while the application is running to accommodate temperature drifts in CTs, but conversions on the $\Sigma\Delta$ must be stopped while changes are made to the phase compensation.

4.4 Energy Meter Configuration

Include files are used to initialize and configure the energy meter to perform several metrology functions. This section describes the user-configurable options. The main user-configurable options are within the following three files: metrology-calibration-template.h, metrology-template.h, and emeter-template.h. Note that some options are dependent on other options. Therefore, some other options may automatically be enabled if a particular option is selected. Many of the option associations are listed in the metrology-interactions.h file.

4.4.1 metrology-calibration-template.h

The metrology-calibration-template file contains the default calibration values that are first programmed into a meter before calibration. This file is located within the \emeter-metrology\emeter-metrology-i2041 directory. The relevant calibration factor macros are:

- **DEFAULT_V_RMS_SCALE_FACTOR_A:** This macro holds the scaling factor for voltage at phase A for the two-phase configuration and the common voltage for both the common-voltage configuration and the neutral-monitoring configuration. Set this factor to an approximately correct value, and it will be fine tuned during calibration.
- **DEFAULT_V_DC_ESTIMATE_A:** This macro holds an estimate for the dc level of the voltage channel at phase A for the two-phase configuration and the common voltage for both the common-voltage configuration and the neutral-monitoring configuration. Using this estimate helps reduce the initial settling time of the dc voltage filter for phase A.
- **DEFAULT_V_AC_OFFSET_A:** This macro removes the effect of the Additive White Gaussian Noise from the voltage ADC of phase A for the two-phase configuration and the common voltage for both the common-voltage configuration and the neutral-monitoring configuration. Additive White Gaussian Noise is orthogonal to everything except itself. This results in the noise squaring when performing calculations for RMS voltage. When performing calculations for RMS voltage, this macro is subtracted out from the mean-squared voltage before its square root is taken to produce RMS voltage. Set this factor to an approximately correct value, and it will be fine tuned during calibration.
- **DEFAULT_V_RMS_SCALE_FACTOR_B:** This macro holds the scaling factor for voltage at phase B for the two-phase configuration. Set this factor to an approximately correct value, and it will be fine tuned during calibration.
- **DEFAULT_V_DC_ESTIMATE_B:** This macro holds an estimate for the dc level of the voltage channel of phase B for the two-phase configuration. Using this estimate helps reduce the initial settling time of the dc voltage filter for phase B.
- **DEFAULT_V_AC_OFFSET_B:** This macro removes the effect of the Additive White Gaussian Noise from the voltage ADC of phase B for the two-phase configuration. Additive White Gaussian Noise is orthogonal to everything except itself. This results in the noise squaring when performing calculations for RMS voltage. When performing calculations for RMS voltage, this macro is subtracted out from the mean-squared voltage before its square root is taken to produce RMS voltage. Set this factor to an approximately correct value, and it will be fine tuned during calibration.
- **DEFAULT_I_RMS_SCALE_FACTOR_A:** This macro holds the scaling factor for current at phase A for the two-phase configuration, the live current for the neutral-monitoring configuration, and channel A for the common-voltage configuration. Set this factor to an approximately correct value, and it will be fine tuned during calibration.
- **DEFAULT_I_DC_ESTIMATE_A :** This macro holds an estimate for the dc level of the current channel of phase A for the two-phase configuration, the live current for the neutral-monitoring configuration, and channel A for the common-voltage configuration. Using this estimate helps reduce the initial settling time of the dc current filter for phase A.
- **DEFAULT_I_AC_OFFSET_A:** This macro removes the effect of the Additive White Gaussian Noise from the current ADC of phase A for the two-phase configuration, the live current for the neutral-monitoring configuration, and channel A for the common-voltage configuration. Additive White Gaussian Noise is orthogonal to everything except itself. This results in the noise squaring when performing calculations for RMS current. When performing calculations for RMS current, this macro is subtracted out from the mean-squared current before its square root is taken to produce RMS current. Set this factor to an approximately correct value, and it will be fine tuned during calibration.
- **DEFAULT_I_RMS_SCALE_FACTOR_B:** This macro holds the scaling factor for current at phase B for

the two-phase configuration and channel B for the common-voltage configuration. Set this factor to an approximately correct value, and it will be fine tuned during calibration.

- **DEFAULT_I_DC_ESTIMATE_B:** This macro holds an estimate for the dc level of the current channel of phase B for the two-phase configuration and channel B for the common-voltage configuration. Using this estimate helps reduce the initial settling time of the dc current filter for phase B.
- **DEFAULT_I_AC_OFFSET_B:** This macro removes the effect of the Additive White Gaussian Noise from the current ADC of phase B for the two-phase configuration and channel B for the common-voltage configuration. Additive White Gaussian Noise is orthogonal to everything except itself. This results in the noise squaring when performing calculations for RMS current. When performing calculations for RMS current, this macro is subtracted out from the mean-squared current before its square root is taken to produce RMS current. Set this factor to an approximately correct value, and it will be fine tuned during calibration.
- **DEFAULT_I_RMS_SCALE_FACTOR_C:** This macro holds the scaling factor for current at channel C for the common-voltage configuration. Set this factor to an approximately correct value, and it will be fine tuned during calibration.
- **DEFAULT_I_DC_ESTIMATE_C:** This macro holds an estimate for the dc level of the current channel of channel C for the common-voltage configuration. Using this estimate helps reduce the initial settling time of the dc current filter for phase C.
- **DEFAULT_I_AC_OFFSET_C:** This macro removes the effect of the Additive White Gaussian Noise from the current ADC of channel C. Additive White Gaussian Noise is orthogonal to everything except itself. This results in the noise squaring when performing calculations for RMS current. When performing calculations for RMS current, this macro is subtracted out from the mean-squared current before its square root is taken to produce RMS current. Set this factor to an approximately correct value, and it will be fine tuned during calibration.
- **DEFAULT_P_SCALE_FACTOR_A:** This macro holds the scaling factor for active power at phase A for the two-phase configuration, the live current for the neutral-monitoring configuration, and channel A for the common-voltage configuration. Set this factor to an approximately correct value, and it will be fine tuned during calibration.
- **DEFAULT_P_SCALE_FACTOR_B:** This macro holds the scaling factor for active power at phase B for the two-phase configuration and channel B for the common-voltage configuration. Set this factor to an approximately correct value, and it will be fine tuned during calibration.
- **DEFAULT_P_SCALE_FACTOR_C:** This macro holds the scaling factor for active power at channel C for the common-voltage configuration. Set this factor to an approximately correct value, and it will be fine tuned during calibration.
- **DEFAULT_BASE_PHASE_A_CORRECTION:** This macro holds the value for phase correction to compensate for delay due to the current transformer/front-end circuitry at phase A for the two-phase configuration, the live current for the neutral-monitoring configuration, and channel A for the common-voltage configuration. This can be set to a value that is in fairly acceptable range, and it will be fine tuned under phase correction during calibration.
- **DEFAULT_BASE_PHASE_B_CORRECTION:** This macro holds the value for phase correction to compensate for delay due to the current transformer/front-end circuitry at phase B for the two-phase configuration and channel B for the common-voltage configuration. This can be set to a value that is in fairly acceptable range, and it will be fine tuned under phase correction during calibration.
- **DEFAULT_BASE_PHASE_C_CORRECTION:** This macro holds the value for phase correction to compensate for delay due to the current transformer/front-end circuitry at channel C for the common-voltage configuration. This can be set to a value that is in fairly acceptable range, and it will be fine tuned under phase correction during calibration.

4.4.2 metrology-template.h

The metrology-template file contains the different user-configurable metrology-related options. This file is located within the "emeter-metrology\emeter-metrology-i2041" directory. The relevant user-configurable options are:

- **CONFIGURATION_COMMON_VOLTAGE**: This selects common-voltage configuration. In this configuration, one voltage channel is used and three currents. When selecting this option, **CONFIGURATION_TWO_PHASES** and **CONFIGURATION_NEUTRAL_MONITORING** options should be disabled. Make sure that the hardware supports the configuration selected in hardware by making sure that the JMP2 and JMP3 resistor jumpers are properly placed.
- **CONFIGURATION_NEUTRAL_MONITORING**: This selects neutral-monitoring configuration. In this configuration, one voltage channel is used and two currents where one current is the live and the other is the neutral. When selecting this option, **CONFIGURATION_TWO_PHASES** and **CONFIGURATION_COMMON_VOLTAGE** options should be disabled.
- **CONFIGURATION_TWO_PHASES**: This selects two-phase configuration. In this configuration, two voltages and two currents are used. When selecting this option, **CONFIGURATION_NEUTRAL_MONITORING** and **CONFIGURATION_COMMON_VOLTAGE** options should be disabled. Make sure that the hardware supports the configuration selected in hardware by making sure that the JMP2 and JMP3 resistor jumpers are properly placed.
- **CURRENT_CHANNEL_PULSE_OUTPUT**: For common-voltage configuration, change this value to the channel to be tied with the active and reactive LEDs. This macro has potential values of 0, 1, and 2 to correspond to channels A, B, and C. Note that this is only applicable to the common-voltage configuration. For the other configurations, this macro is ignored.
- **VOLTAGE_SIGNAL_IS_COMMON**: This macro selects the case where there is one voltage channel and three current channels. This macro should not be modified manually because it would automatically be selected the selecting the configuration (between items 1-3 above).
- **NEUTRAL_MONITOR_SUPPORT**: This macro selects the case where neutral-monitoring is enabled. This macro should not be modified manually because it would automatically be selected the selecting the configuration (between items 1-3 above).
- **SELECTED_STRUCT_CONFIGURATION**: This macro designates which configuration (between items 1-3 above) is selected.
- **NUM_PHASES**: This selects the number of current channels (with the neutral channel excluded) in the selected configuration. This value is automatically selected based on the chosen configuration (between items 1-3 above). It should not be manually changed.
- **NUM_CURRENT_CHANNELS**: This selects the number of current channels in the selected configuration. This value is automatically selected based on the chosen configuration (between items 1-3 above). It should not be manually changed.
- **VOLTAGE_CHANNELS**: This selects the number of voltage channels in the selected configuration. This value is automatically selected based on the chosen configuration (between items 1-3 above). It should not be manually changed.
- **TWENTYFOUR_BIT**: This selects the resolution of the current channels. If it is defined, 24-bit samples are used for current. If it is not defined, 16-bits are used for voltage. Because there is no benefit in using a smaller resolution, this macro should be left defined and not be disabled.
- **PHASE_1_CURRENT_ADC_CHANNEL**: This defines the Sigma Delta converter number that corresponds to Phase 1 (phase A) for the two-channel configuration, the live current for the neutral-monitoring configuration, and Channel A for the common-voltage configuration.
- **PHASE_1_VOLTAGE_ADC_CHANNEL**: This defines the Sigma Delta channel that is associated with phase 1 (phase A), and the shared voltage for both the common-voltage configuration and the neutral-monitoring configuration.
- **NEUTRAL_CURRENT_ADC_CHANNEL**: This defines the Sigma Delta converter number that corresponds to the neutral current channel for the neutral-monitoring configuration. This is not defined for the common-voltage and two-phase configurations.
- **PHASE_2_CURRENT_ADC_CHANNEL**: This defines the Sigma Delta converter number that corresponds to Phase 2(phase B) and channel B for the common-voltage configuration. This is not defined for the neutral-monitoring configuration.

- **PHASE_2_VOLTAGE_ADC_CHANNEL:** This defines the Sigma Delta channel that is associated with phase 2 (phase B) for the two-phase configuration. This is not defined for the neutral-monitoring configuration and the common-voltage configuration.
- **PHASE_3_CURRENT_ADC_CHANNEL:** This defines the Sigma Delta converter number that is associated with channel C for the two-phase configuration. This is not defined for the neutral-monitoring and two-phase configurations.
- **PHASE_1_DELAY_SPLIT:** This is used to determine when to collect current 1 samples in the SD24 ISR.
- **PHASE_2_DELAY_SPLIT:** This is used to determine when to collect current 2 samples in the SD24 ISR.
- **PHASE_3_DELAY_SPLIT:** This is used to determine when to collect current 3 samples in the SD24 ISR.
- **NEUTRAL_DELAY_SPLIT:** This is used to determine when to collect the neutral current sample in the SD24 ISR.
- **SD_LIVE_CURRENT_GAIN:** This macro defines the gain of the SD24's internal programmable gain amplifier (PGA) for all of the current channels (except neutral). In this application it is set to 1.
- **SD_NEUTRAL_CURRENT_GAIN:** This macro defines the gain of the SD24's internal programmable gain amplifier (PGA) the neutral channel. In this application it is set to 1.
- **SD_VOLTAGE_GAIN:** This macro defines the gain of the SD24's internal programmable gain amplifier (PGA) for all voltages. In this application it is set to 1.
- **MAINS_NOMINAL_FREQUENCY:** The nominal mains frequency, in Hz that is used to prime the mains frequency filter to make it settle more quickly.
- **MAINS_NOMINAL_VOLTAGE:** This selects the nominal voltage used for sag/swell detection.
- **MAINS_BASIS_CURRENT:** This selects the basis current.
- **MAINS_MAXIMUM_CURRENT:** This selects the maximum operating current.
- **MAINS_FREQUENCY_SUPPORT:** The macro configures the meter to measure the frequency of the ac mains.
- **VRMS_SUPPORT:** This macro is used to configure the meter to calculate VRMS from the voltage samples.
- **SAG_SWELL_SUPPORT:** This selects support for sag and swell detection.
- **SAG_SWELL_WINDOW_LEN:** This selects the number of mains cycles over which sag and swell detection works.
- **SAG_THRESHOLD:** This selects the percentage fall from the nominal voltage for sag detection.
- **SWELL_THRESHOLD:** This selects the percentage rise above the nominal voltage for swell detection.
- **REACTIVE_POWER_SUPPORT:** This selects support for reactive power measurement.
- **REACTIVE_POWER_BY_QUADRATURE_SUPPORT:** This selects support for reactive power measurement through quadrature processing. This is only effective when **REACTIVE_POWER_SUPPORT** is enabled.
- **APPARENT_POWER_SUPPORT:** The selects support for apparent or VA power measurement.
- **POWER_FACTOR_SUPPORT:** This macro is used to configure the meter to calculate the power factor for both lead and lag. A frequency independent method, based on the ratio of scalar dot products, is used.
- **RESIDUAL_POWER_CUTOFF:** Tiny power levels should not record energy at all, as they may just be rounding errors, noise, or the consumption of the meter itself. This value is the cutoff level in milliwatts (this is the cutoff per phase).
- **TOTAL_RESIDUAL_POWER_CUTOFF:** Tiny power levels should not record at all, as they may just be rounding errors, noise, or the consumption of the meter itself. This value is the cutoff level, in 0.01-W increments (this is the cutoff for the aggregate power). This is disabled for the neutral-monitoring configuration.
- **ACTIVE_ENERGY_SUPPORT:** This switch selects support for measuring the active energy consumption on a phase by phase basis. This will allow the GUI to display each phase's active energy consumption in kWh.

- **ACTIVE_ENERGY_PULSES_PER_KW_HOUR:** This macro defined the total number of pulses per 1 kWh of active energy at each phase. In this application it is defined to 6400 if pulses generation for each individual phase has been enabled. If the value of this macro is increased, it may be necessary to decrease the pulse duration.
- **REACTIVE_ENERGY_SUPPORT:** This switch selects support for measuring the reactive energy consumption on a phase by phase basis. This will allow the GUI to display each phase's reactive energy consumption in kvarh.
- **APPARENT_ENERGY_SUPPORT:** This switch selects support for measuring the apparent energy consumption on a phase by phase basis. This will allow the GUI to display each phase's apparent energy consumption in kVA.
- **TOTAL_ACTIVE_ENERGY_SUPPORT:** This switch selects support for measuring the total active energy consumption. This will allow the GUI to display the cumulative phase's active energy consumption in kWh. This is disabled for the neutral-monitoring configuration.
- **TOTAL_REACTIVE_ENERGY_SUPPORT:** This switch selects support for measuring the total reactive energy consumption. This will allow the GUI to display the cumulative phase's reactive energy consumption in kvarh. This is disabled for the neutral-monitoring configuration.
- **TOTAL_APPARENT_ENERGY_SUPPORT:** This switch selects support for measuring the total apparent energy consumption. This will allow the GUI to display the cumulative phase's apparent energy consumption in kVA. This is disabled for the neutral-monitoring configuration.
- **TOTAL_ACTIVE_ENERGY_PULSES_PER_KW_HOUR:** This sets the number of pulses per kilo-watt hour the meter will produce at its total active energy pulse. It does not affect the energy accumulation process. The default setting for this macro is 6400.
- **TOTAL_REACTIVE_ENERGY_PULSES_PER_KVAR_HOUR:** This sets the number of pulses per kilo-var hour the meter will produce at its total reactive energy pulse. It does not affect the energy accumulation process. The default setting for this macro is 6400. This is disabled for the neutral-monitoring configuration.
- **ENERGY_PULSE_DURATION:** The duration of the LED on time for an energy pulse. This is measured in ADC samples (that is, increments 1/4000 s). The maximum allowed is 255, giving a pulse of approximately 64 ms. The default value for this macro is 80. For higher pulses/kWh constants, the value for this macro may need to be reduced.
- **PRECALCULATED_PARAMETER_SUPPORT:** Normally the meter software only calculates the properly scaled values for voltage, current, etc. as these values are needed. This define enables additional global parameters, which are regularly updated with all the metrics gathered by the meter. This is generally less efficient, as it means calculating things more often than necessary. However, some may find this easier to use, so it is offered as a choice for the meter designer.
- **PER_SENSOR_PRECALCULATED_PARAMETER_SUPPORT:** This enables holding readings per sensor.
- **custom_adc_interrupt():** This is called every ADC interrupt, after the main DSP work has finished. It can be used for things like custom keypad operations. It is important this is a very short routine, as it is called from the main ADC interrupt.

4.4.3 emeter-template.h

The emeter-template file contains the different user-configurable application-related options. This file is located within the "emeter-app\emeter-app-i2041" directory. The relevant user-configurable options are:

- SERIAL_CALIBRATION_SUPPORT: This switch, in combination with the calibrator switch, enables calibration with the meter cooperating with an external reference, through a UART port.
- SERIAL_CALIBRATION_REF_SUPPORT: This switch enables the sending of the current readings, through a UART port, for use in cooperative calibration with other meters.
- DLT645_SUPPORT: This macro enables DLT645 communication.
- custom_active_energy_pulse_start: This macro defines the command used to turn on the active energy LED for a pulse. Note that for the common-voltage configuration, a pulse is output only for the selected current channel. For the neutral-monitoring configuration, a pulse is output based on the live current. Finally, for the two-phase configuration, a pulse is output for the cumulative two-phase energy.
- custom_active_energy_pulse_end: This macro defines the command used to turn off the active energy LED for a pulse. Note that for the common-voltage configuration, a pulse is output only for the selected current channel. For the neutral-monitoring configuration, a pulse is output based on the live current. Finally, for the two-phase configuration, a pulse is output for the cumulative two-phase energy.
- custom_reactive_energy_pulse_start: This macro defines the command used to turn on the reactive energy LED for a pulse. Note that for the common-voltage configuration, a pulse is output only for the selected current channel. For the neutral-monitoring configuration, a pulse is output based on the live current. Finally, for the two-phase configuration, a pulse is output for the cumulative two-phase energy.
- custom_reactive_energy_pulse_end: This macro defines the command used to turn off the reactive energy LED for a pulse. Note that for the common-voltage configuration, a pulse is output only for the selected current channel. For the neutral-monitoring configuration, a pulse is output based on the live current. Finally, for the two-phase configuration, a pulse is output for the cumulative two-phase energy.

In addition to the above macros, there are macros that are used to initialize the values of the DIR, SEL, OUT, and REN registers of each port. In the software, these values are set to values to correspond to the hardware of this EVM.

5 Energy Meter Demo

The energy meter evaluation module (EVM) associated with this application report specifically uses the MSP430i2041 device of the MSP430i204x and the MSP430F6638 of the MSP430F663x chips. The complete demonstration platform consists of the EVM that can be easily hooked to any test system, metrology software and a PC GUI, which is used to view results and perform calibration.

5.1 EVM Overview

The following figures of the EVM show the hardware. [Figure 15](#) is the top view of the energy meter. [Figure 16](#) shows the location of various pieces of the EVM based on functionality.

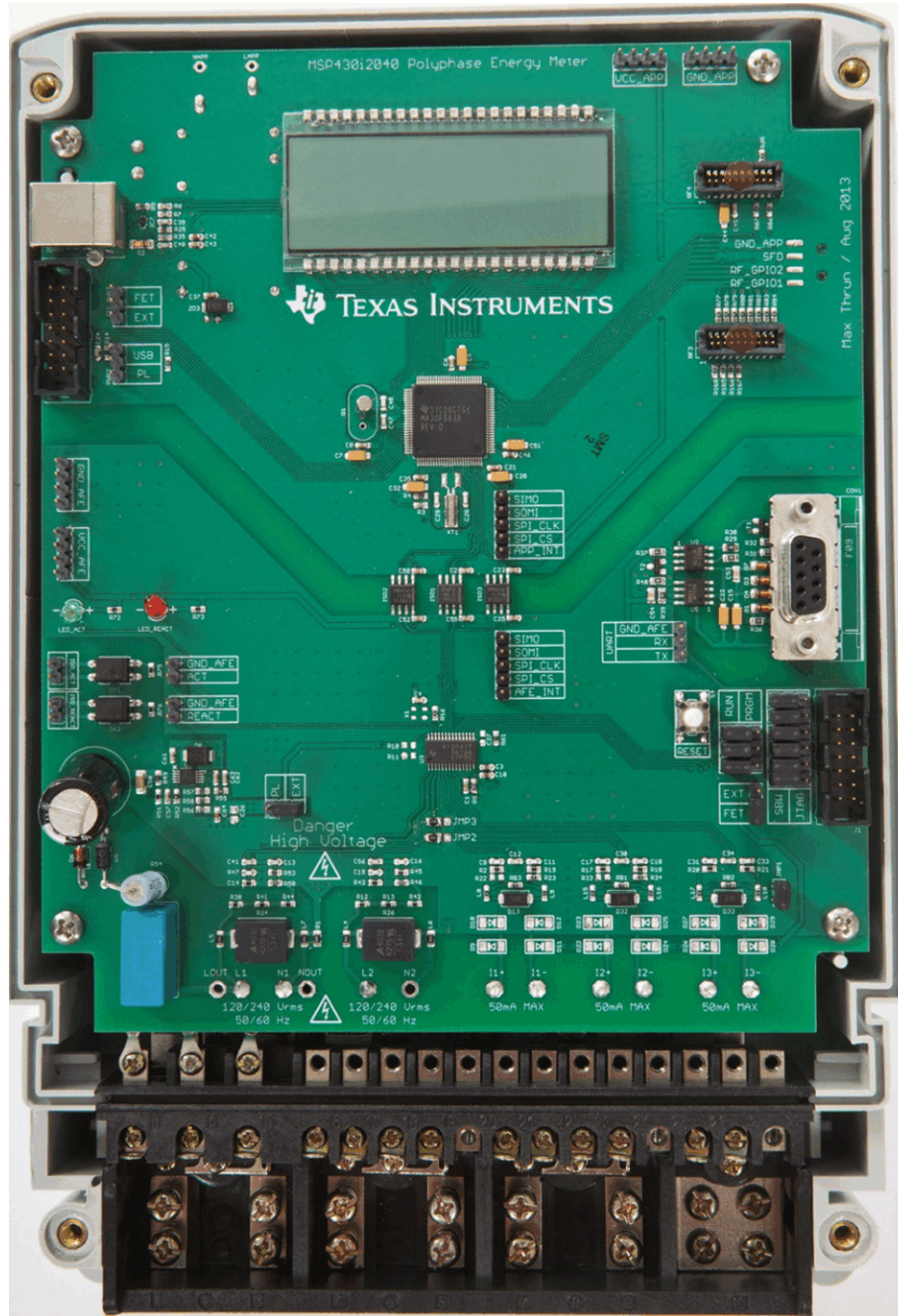

Figure 15. Top View of the Energy Meter EVM

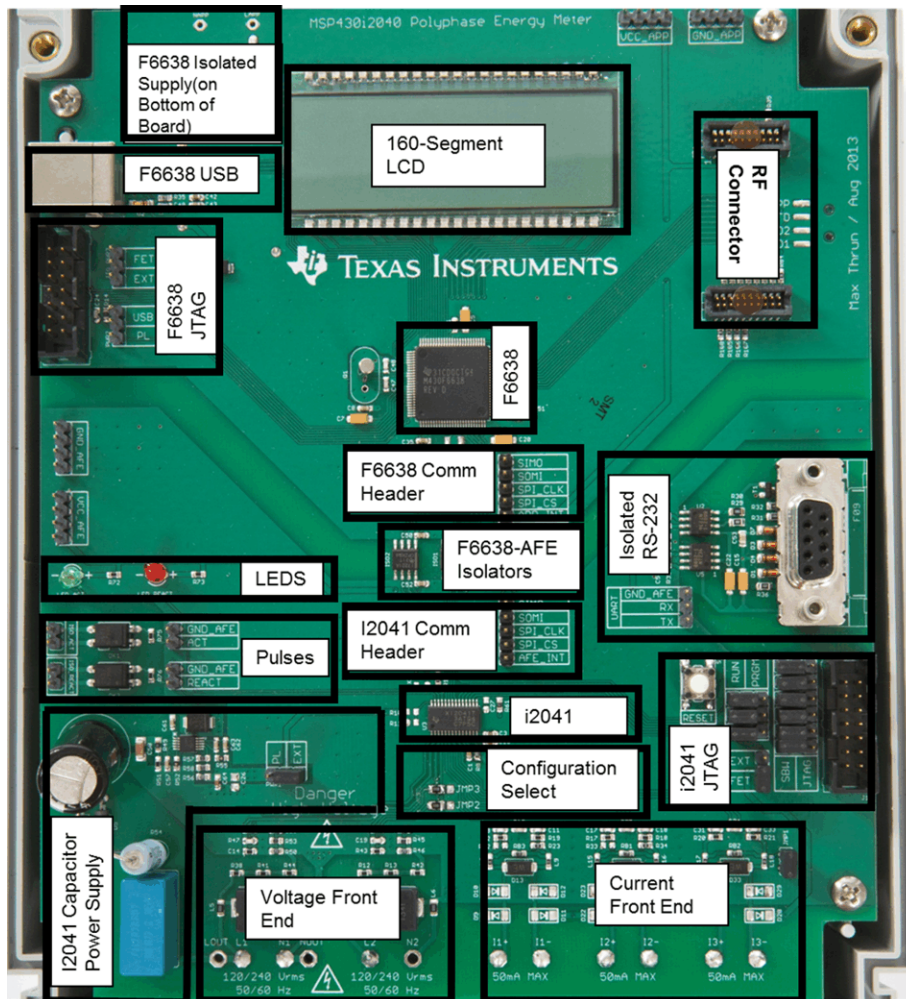

Figure 16. Top View of the EVM With Components Highlighted

	<p>Danger High Voltage</p>	<p>Electric shock possible when connecting board to live wires. Board should be handled with care by a professional. For safety, use of isolated test equipment with overvoltage and overcurrent protection is highly recommended.</p>
--	---------------------------------------	---

5.1.1 Connections to the Test Setup or AC Voltages

CAUTION

Do not leave EVM powered when unattended.

To properly connect the EVM430-i2040 to a voltage/current source, the proper connections must be made. These necessary connections are dependent on which of the three measurement configurations are selected. In this EVM, the JMP2 and JMP3 jumper resistors are provided to switch between the hardware setting for different configurations. When both the JMP2 and JMP3 0-Ω resistors are placed on the two left-most positions of these three-pad jumpers, the voltage front-end circuitry for pad L2 is connected to the MSP430i2041. This selection is necessary for the two-phase configuration. In contrast, when both the JMP2 and JMP3 0-Ω resistors are placed on the two right-most pads of these three-pad jumpers, the current front-end circuitry for pad I1 is connected to the MSP430i2041. This selection is necessary for the common-voltage configuration.

CAUTION

Because the JMP2 and JMP3 three-footprint pads connect an ADC channel to either voltage front-end circuitry or current front-end circuitry, the three pads of either JMP2 or JMP3 should never all be shorted together. Only two pads of each pad should be shorted at a time. Also, both resistors for JMP2 and JMP3 should be in the same position. The JMP2 and JMP3 resistors should either be both on the left two pads or both on the right two pads.

AC voltage or currents can be applied to the board for testing purposes at these points:

- Pad L1 corresponds to the line connection for phase A.
- Pad L2 corresponds to the line connection for phase B. To enable this option, the resistor for JMP2 and JMP3 resistors should be placed on the two left-most positions. This pad's associated voltage front-end circuitry will only be connected to the MSP430i2041 when JMP2 and JMP3 are configured for two-phase measurement.
- Pad N1 corresponds to the Neutral voltage. The voltage between any of the two possible line connections to the neutral connection can be up to 230 V ac at 50/60 Hz.
- I1+ and I1- are only valid in the common-voltage configuration. In this configuration, these pads are the current inputs after the sensors for channel A. To enable this option, the resistor for JMP2 and JMP3 should be placed on the two right-most positions. Note that when a current sensor is used, make sure that the voltage across I1+ and I1- does not exceed 928 mV.
- For the neutral-monitoring configuration, I2+ and I2- are the current inputs after the sensors for the live current (current A). When the two-phase configuration is selected, I2+ and I2- are the current inputs after the sensors for phase A. In the third configuration, the common-voltage configuration, I2+ and I2- are the current inputs after the sensors for channel B. Note that when a current sensor is used, make sure that the voltage across I2+ and I2- does not exceed 928 mV.
- For the neutral-monitoring configuration, I3+ and I3- are the current inputs after the sensors for the neutral current (current N). When the two-phase configuration is selected, I3+ and I3- are the current inputs after the sensors for phase B. In the third configuration, the common-voltage configuration, I3+ and I3- are the current inputs after the sensors for channel C. Note that when a current sensor is used, make sure that the voltage across I3+ and I3- does not exceed 928 mV.

Figure 17 through Figure 21 show the various connections that need to be made to the test setup for different measurement configurations.

When a test ac source needs to be connected, the connections must be made according to the EVM design. Figure 17 shows the connections from the top view for both the neutral-monitoring and common-voltage configurations while Figure 18 shows the connections from the top view for the two-phase configuration. In the figures, VA+ , VB+, and corresponds to the line voltage for phases A and B, respectively. VN corresponds to the neutral voltage from the test ac source.



Figure 17. Top View of EVM with Test Setup Connections, Neutral-Monitoring and Common-Voltage

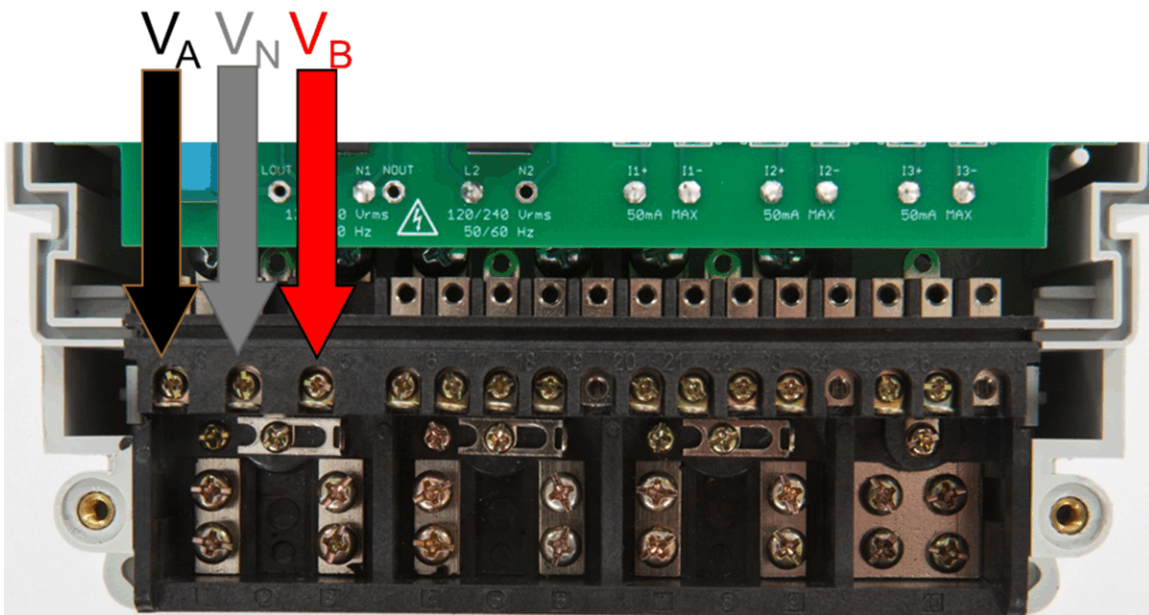

Figure 18. Top View of EVM with Test Setup Connections, Two-Phase

Figure 19 shows the connections from the front view for the common-voltage configuration, Figure 20 shows the connections from the front view for the neutral-monitoring configuration, and Figure 21 shows the connections from the front view for the two-phase configuration. IA+ and IA- correspond to the current inputs for phase/channel A or the live current, IB+ and IB- correspond to the current inputs for phase/channel B, IC+ and IC- correspond to the current inputs for phase C, and IN+ and IN- correspond to the current inputs for the neutral current.

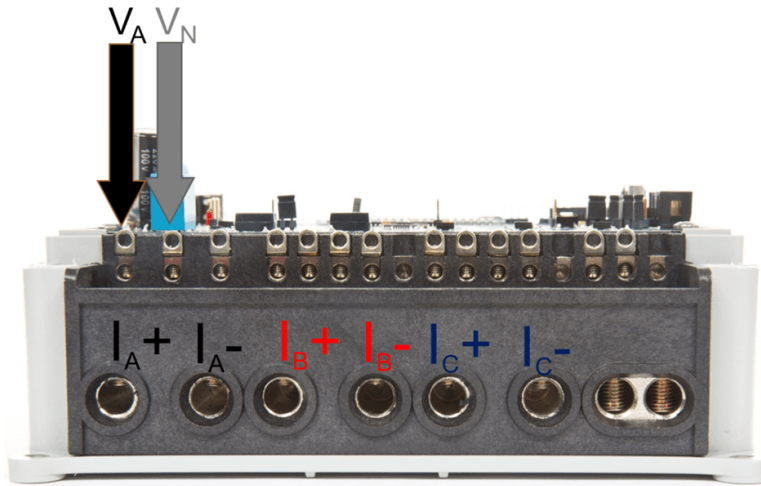

Figure 19. Front View of the EVM With Test Setup Connections, Common-Voltage

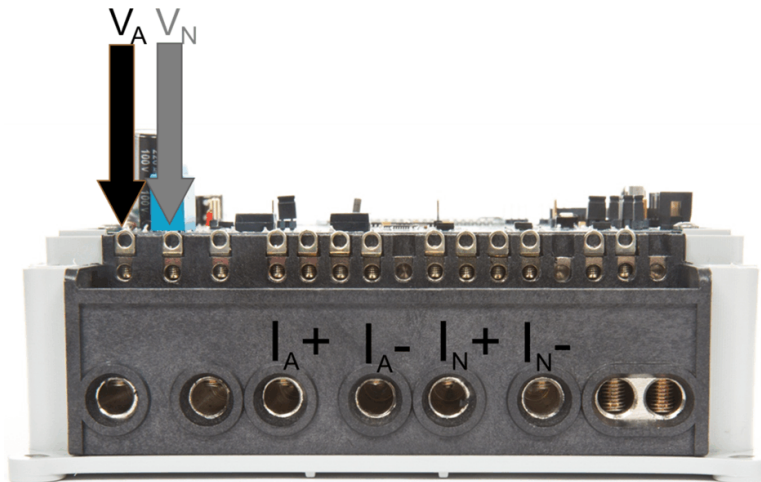

Figure 20. Front View of the EVM With Test Setup Connections, Neutral-Monitoring

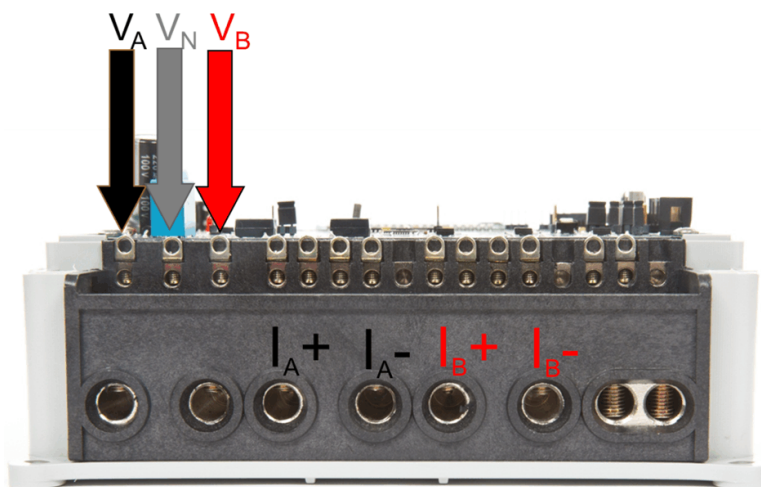

Figure 21. Front View of the EVM With Test Setup Connections, Two-Phase

5.1.2 Power Supply Options and Jumper Settings

The EVM can be configured to operate with different sources of power. The MSP430i2041 portion of the board can be powered by a single dc voltage rail (VCC_AFE), which can be derived either via JTAG, external power, or ac mains through a capacitive power supply. The MSP430F6638 portion of the board can be powered by a single dc voltage rail (VCC_APP), which can be derived either via JTAG, USB, external power, or ac mains through an isolated power supply. Various jumper headers and jumper settings are present to add to the flexibility to the board. Some of these headers require that jumpers be placed appropriately for the board to correctly function. [Table 1](#) indicates the functionality of each MSP430i2041 jumper on the board and the associated functionality in addition to the functionality of each MSP430F6638 header.

Table 1. Header Names and Jumper Settings on the EVM430-i2040

Header, Header Option Name	Type	Main Functionality	Valid Use Case	Comments
ACT (Not isolated, do not probe)	2-pin Header on the i2041 portion of the EVM	Active Energy Pulses (WARNING)	Probe here for active energy pulses.	In neutral-monitoring configuration, the active energy associated with the live current is output. For the two-phase configuration, the cumulative two-phase active energy is output. For common-voltage configuration, the active energy pulses for the user-specified current channel is output. This header is not isolated from ac voltage, so do not connect measuring equipments unless isolators external to the EVM are available. See the ISO_ACT header instead.
AFE_INT (Not isolated, do not probe)	1-pin Header on the i2041 portion of the EVM	F6638 interrupt pin on the i2041's side of the F6638-i2041 isolated communication (WARNING)	This pin can be used to provide a port interrupt on the F6638. This pin is driven by the i2041.	This pin is interfaced to the F6638 via on-board isolators. The AFE_INT pin on the i2041's side is not isolated so do not probe if board is powered form ac mains, unless the ac mains are isolated. This voltage can be hot or neutral if ac wall plug is connected to the meter. The isolated version of this signal that is connected to the F6638 is called APP_INT. Also, this 1-pin header is grouped with 4 other 1-pin headers to form the i2041 Comm Header.
APP_INT	1-pin Header on the F6638 portion of the EVM	F6638 interrupt pin on the F6638's side of the F6638-i2041 isolated communication	This pin can be used to provide a port interrupt on the F6638. This pin is driven by the i2041.	This pin is interfaced to the i2041 via on-board isolators. The version of this signal that is connected to the i2041 is called AFE_INT. Also, this 1-pin header is grouped with 4 other 1-pin headers to form the F6638 Comm Header.
EXT (Do not connect JTAG if ac mains is the power source Isolated JTAG or supply is fine)	Jumper Header Option on the i2041 portion of the EVM	JTAG External Power Selection Option (WARNING)	Place a jumper at this header option to select external voltage for JTAG programming of the i2041.	This jumper option and the "FET" jumper option comprise one three-pin header used to select the voltage source for JTAG programming of the i2041. Do not probe if board is powered from ac mains, unless the ac mains are isolated. This voltage can be hot or neutral if ac wall plug is connected to the meter.
FET (Do not connect JTAG if ac mains is the power source).	Jumper Header Option on the i2041 portion of the EVM	JTAG Internal Power Selection Option (WARNING)	Place a jumper at this header option to power the i2041 using JTAG and to select the voltage from the USB FET for JTAG programming.	This jumper option and the "EXT" jumper option comprise one three-pin header used to select the voltage source for JTAG programming of the i2041. Do not probe if board is powered from ac mains, unless the ac mains are isolated. This voltage can be hot or neutral if ac wall plug is connected to the meter.
GND_AFE (Not isolated, do not probe)	Header on the i2041 portion of the EVM	i2041 Ground Voltage Header (WARNING)	Not a jumper header, probe here for GND voltage for the i2041. Connect negative terminal of bench or external power supply when powering the board externally.	Do not probe if board is powered form ac mains, unless the ac mains are isolated. This voltage can be hot or neutral if ac wall plug is connected to the meter.
GND_APP	Header on the F6638 portion of the EVM	F6638 Ground Voltage Header (WARNING)	Not a jumper header, probe here for GND voltage for the F6638. Connect negative terminal of bench or external power supply when powering the board externally.	Note that DGND_APP is not isolated with USB GND voltages on the EVM.
ISO_ACT	2-pin Header on the i2041 portion of the EVM	Isolated Active Energy Pulses	Probe here for isolated active energy pulses.	This is isolated from ac mains voltage so it is safe to connect a scope or other measuring equipments because isolators are already present on the EVM.

Table 1. Header Names and Jumper Settings on the EVM430-i2040 (continued)

Header, Header Option Name	Type	Main Functionality	Valid Use Case	Comments
ISO_REACT	2-pin Header on the i2041 portion of the EVM	Isolate Reactive Energy Pulses	Probe here for isolated reactive energy pulses.	This is isolated from ac mains voltage so it is safe to connect a scope or other measuring equipments because isolators are already present on the EVM.
JMP1	Jumper Header on the i2041 portion of the EVM	"I3" Current Sensor Reference	Place a jumper here to reference the negative terminal of the "I3" $\Sigma\Delta$ to ground (GND_AFE).	Conditions based on Sensor: CT: Always have a jumper Shunt: Do not connect a jumper
JMP2	3-pad Jumper on the i2041 portion of the EVM	A1.0+ Converter Input Select and Measurement Configuration Select (WARNING)	Place a 0- Ω resistor on the two left-most pads of this 3-pad jumper to connect A1.0+ to the "V2" pad's voltage front end circuitry. Place a 0- Ω resistor on the two right-most pads of this 3-pad jumper to connect A1.0+ to the "I1" pad's current front end circuitry.	A 0- Ω resistor must be placed on the two right-most positions for both JMP2 and JMP3 to configure the hardware for the common-voltage configuration. A 0- Ω resistor must be placed on the two left-most positions for both JMP2 and JMP3 to configure the hardware for the two-phase configuration. All three pads for the JMP2 header must never be shorted together.
JMP3	3-pad Jumper on the i2041 portion of the EVM	A1.0- Converter Input Select and Measurement Configuration Select (WARNING)	Place a 0- Ω resistor on the two left-most pads of this 3-pad jumper to connect A1.0- to the "V2" pad's voltage front end circuitry. Place a 0- Ω resistor on the two right-most pads of this 3-pad jumper to connect A1.0- to the "I1" pad's current front end circuitry.	A 0- Ω resistor must be placed on the two right-most positions for both JMP2 and JMP3 to configure the hardware for the common-voltage configuration. A 0- Ω resistor must be placed on the two left-most positions for both JMP2 and JMP3 to configure the hardware for the two-phase configuration. All three pads for the JMP3 header must never be all shorted together.
JTAG (Do not connect JTAG if ac mains is the power source)	Jumper Header Option on the i2041 portion of the EVM	4-wire JTAG Programming Option (WARNING)	Place jumpers at the JTAG header options of all of the six JTAG communication headers to select 4-wire JTAG.	There are six headers that jumpers must be placed at to select the JTAG communication option. Each of these six headers has a JTAG option and an SBW option to select either 4-wire JTAG or SBW. To enable 4-wire JTAG, configure all of these headers for the JTAG option. To enable SBW, configure all of the headers for the SBW option.
JTG_PWR2	3-pin Jumper Header on F6638 portion of the EVM	JTAG Power Selection	Place a jumper at the FET option to power the F6638 portion of the EVM from the FET and to select the voltage from the USB FET for JTAG programming. Place a jumper at the EXT option, to select external voltage for JTAG programming of the F6638.	
PGM (Do not connect JTAG if ac mains is the power source)	Jumper Header Option on the i2041 portion of the EVM	4-wire JTAG programming Option (WARNING)	When using 4-wire JTAG mode, place jumpers at these options to enable programming the i2041.	There are three headers where jumpers must be placed. Each of these three headers has a PGM option and a RUN option. To enable programming the i2041 in 4-wire JTAG mode, configure all of these headers for the PGM option. To enable use of the UART TX, UART RX, and interrupt pin to the F6638, configure all of these headers to the PGM option. Note that for SBW, the PGM option does not need to be selected to program the i2041. However, for the SBW case, jumpers at "RUN" are still needed to enable use of the UART TX, UART RX, and the interrupt pin for the F6638
PWR1	Jumper Header on the i2041 portion of the EVM	Power Option Select for i2041 (WARNING)	Place a jumper at the "PL" option to power the i2041 from mains. Place a jumper at the "EXT" option to power the i2041 from an external power source such as a FET tool or a bench power supply.	If the PL option is selected, do not debug using JTAG unless ac source is isolated or JTAG is isolated. Also, note that the on-board isolators will need to be removed to allow the power supply to power the i2041.
PWR2	Jumper Header on the F6638 portion of the EVM	Power Option Select for F6638 (WARNING)	Place a jumper at the "PL" option to power the F6638 from mains. Place a jumper at the "PL" option to power the F6638 from USB.	If the "PL" option is selected, note that the "LAPP" and "NAPP" pads must be connected to mains, which is not the default. One way of doing this is by connecting a wire from the LOUT pad to the LAPP Pad and a wire from the NOUT pad to the NAPP pad. By doing this, LAPP and NAPP get connected to the mains voltage at pad L1.

Table 1. Header Names and Jumper Settings on the EVM430-i2040 (continued)

Header, Header Option Name	Type	Main Functionality	Valid Use Case	Comments
REACT (Not isolated, do not probe)	2-pin Header on the i2041 portion of the EVM	Reactive Energy Pulses (WARNING)	Probe here for reactive energy pulses.	In neutral-monitoring configuration, the reactive energy associated with the live current is output. For the two-phase configuration, the cumulative two-phase reactive energy is output. For common-voltage configuration, the reactive energy pulses for the user-specified current channel is output. This header is not isolated from ac voltage, so do not connect measuring equipments unless isolators external to the EVM are available. See the ISO_REACT header instead.
RUN (Do not connect JTAG if ac mains is the power source)	Jumper Header Option on the i2041 portion of the EVM	UART TX, UART RX, and AFE_INT Enable (WARNING)	Place jumpers here to enable the UART TX and UART RX signals which are interfaced to the RS-232 connector on the EVM. Also, place jumpers here to enable the interrupt pin that goes from the i2041 to the F6638.	There are three headers where jumpers must be placed. Each of these three headers has a PGM option and a RUN option. To enable programming the i2041 in 4-wire JTAG mode, configure all of these headers for the PGM option. To enable use of the UART TX, UART RX, and interrupt pin to the F6638, configure all of these headers to the PGM option. Note that for SBW, the PGM option does not need to be selected to program the i2041. However, for the SBW case, jumpers at "RUN" are still needed to enable use of the UART TX, UART RX, and the interrupt pin for the F6638.
RX (Not isolated, do not probe)	1-pin header on the i2041 portion of the EVM	RS-232 Receive (to MSP430) (WARNING)	This is the UART RX line associated with the i2041's RS-232 connection.	This pin correspond to the UART RX signal and is not the associated translated RS-232 signals; therefore, it has the UART voltage levels and not RS232 voltage levels. Do not probe if board is powered form ac mains, unless the ac mains are isolated. This voltage can be hot or neutral if ac wall plug is connected to the meter.
SBW (Do not connect JTAG if ac mains is the power source)	Jumper Header Option on the i2041 portion of the EVM	SBW JTAG Programming Option (WARNING)	Place jumpers at the SBW header options of all of the six JTAG communication headers to select SBW	There are six headers that jumpers must be placed at to select the JTAG communication option. Each of these six headers has a JTAG option and an SBW option to select either 4-wire JTAG or SBW. To enable 4-wire JTAG, configure all of these headers for the JTAG option. To enable SBW, configure all of the headers for the SBW option.
SIMO	1-pin Header on the F6638 portion of the EVM	SPI SIMO pin on the F6638's side of the F6638-i2041 isolated communication	This contains the SPI SIMO line that is connected to the F6638. It is the SPI input for the i2041.	This pin is interfaced to the i2041 via on-board isolators. The version of this signal that is connected to the i2041 is also called SIMO. This 1-pin header is grouped with 4 other 1-pin headers to form the F6638 Comm Header.
SIMO	1-pin Header on the i2041 portion of the EVM	SPI SIMO pin on the i2041's side of the F6638-i2041 isolated communication (WARNING)	This contains the SPI SIMO line that is connected to the i2041. It is the SPI input for the i2041.	This pin is interfaced to the F6638 via on-board isolators. The SIMO line on the i2041's side is not isolated so do not probe if board is powered form ac mains, unless the ac mains are isolated. This voltage can be hot or neutral if ac wall plug is connected to the meter. The isolated version of this signal, which is connected to the F6638, is also called SIMO. This 1-pin header is grouped with 4 other 1-pin headers to form the i2041 Comm Header.
SOMI	1-pin Header on the F6638 portion of the EVM	SPI SOMI pin on the F6638's side of the F6638-i2041 isolated communication	This contains the SPI SOMI line that is connected to the F6638. It is the SPI output from the i2041.	This pin is interfaced to the i2041 via on-board isolators. The version of this signal that is connected to the i2041 is also called SOMI. This 1-pin header is grouped with 4 other 1-pin headers to form the F6638 Comm Header.
SOMI	1-pin Header on the i2041 portion of the EVM	SPI SOMI pin on the i2041's side of the F6638-i2041 isolated communication (WARNING)	This contains the SPI SOMI line that is connected to the i2041. It is the SPI output from the i2041.	This pin is interfaced to the F6638 via on-board isolators. The SOMI line on the i2041's side is not isolated so do not probe if board is powered form ac mains, unless the ac mains are isolated. This voltage can be hot or neutral if ac wall plug is connected to the meter. The isolated version of this signal, which is connected to the F6638, is also called SOMI. This 1-pin header is grouped with 4 other 1-pin headers to form the i2041 Comm Header.

Table 1. Header Names and Jumper Settings on the EVM430-i2040 (continued)

Header, Header Option Name	Type	Main Functionality	Valid Use Case	Comments
SPI_CLK	1-pin Header on the F6638 portion of the EVM	SPI Clock on the F6638's side of the F6638-i2041 isolated communication	This contains the SPI Clock for SPI communication between the F6638 and i2041. This pin is driven by the F6638.	This pin is interfaced to the i2041 via on-board isolators. The version of this signal that is connected to the i2041 is also called SPI_CLK. This 1-pin header is grouped with 4 other 1-pin headers to form the F6638 Comm Header.
SPI_CLK	1-pin Header on the i2041 portion of the EVM	SPI Clock on the i2041's side of the F6638-i2041 isolated communication (WARNING)	This contains the SPI Clock for SPI communication between the F6638 and i2041. This pin is driven by the F6638.	This pin is interfaced to the F6638 via on-board isolators. The SPI_CLK line on the i2041's side is not isolated so do not probe if board is powered form ac mains, unless the ac mains are isolated. This voltage can be hot or neutral if ac wall plug is connected to the meter. The isolated version of this signal, which is connected to the F6638, is also called SPI_CLK. This 1-pin header is grouped with 4 other 1-pin headers to form the i2041 Comm Header.
SPI_CS	1-pin Header on the F6638 portion of the EVM	SPI Chip Select on the F6638's side of the F6638-i2041 isolated communication	This contains a possible SPI chip select to enable communication with the i2041. This pin is driven by the F6638.	This pin is interfaced to the i2041 via on-board isolators. The version of this signal that is connected to the i2041 is also called SPI_CS. This 1-pin header is grouped with 4 other 1-pin headers to form the F6638 Comm Header.
SPI_CS	1-pin Header on the i2041 portion of the EVM	SPI Chip Select on the i2041's side of the F6638-i2041 isolated communication (WARNING)	This contains a possible SPI chip select to enable communication with the i2041. This pin is driven by the F6638.	This pin is interfaced to the F6638 via on-board isolators. The SPI_CS line on the i2041's side is not isolated so do not probe if board is powered form ac mains, unless the ac mains are isolated. This voltage can be hot or neutral if ac wall plug is connected to the meter. The isolated version of this signal, which is connected to the F6638, is also called SPI_CS. This 1-pin header is grouped with 4 other 1-pin headers to form the i2041 Comm Header.
TX (Not isolated, do not probe)	1-pin Header on the i2041 portion of the EVM	RS-232 Transmit (from MSP430) (WARNING)	This is the UART TX line associated with the i2041's RS-232 connection.	This pin corresponds to the UART TX signal and is not the associated translated RS-232 signals; therefore, it has the UART voltage levels and not RS232 voltage levels. Do not probe if board is powered form ac mains, unless the ac mains are isolated. This voltage can be hot or neutral if ac wall plug is connected to the meter.
VCC_AFE (Not isolated, do not probe)	Header on the i2041 portion of the EVM	i2041 VCC Voltage Header (WARNING)	Not a jumper header, probe here for VCC voltage for the i2041. Connect positive terminal of bench or external power supply when powering the board externally.	Do not probe if board is powered form ac mains, unless the ac mains are isolated. This voltage can be hot or neutral if ac wall plug is connected to the meter.
VCC_APP	Header on the F6638 portion of the EVM	F6638 VCC Voltage Header (WARNING)	Not a jumper header, probe here for VCC voltage for the F6638. Connect positive terminal of bench or external power supply when powering the board externally.	Note that DGND_APP is not isolated with USB GND voltages on the EVM.

5.2 Loading the Example Code

The source code is developed in the IAR Embedded Workbench™ environment using IAR version 5.60.7 for the MSP430 IDE and version 6.6.4.2867 for the IAR Embedded Workbench common components. The current version of IAR can be viewed from the "Product Info" option in the Help menu.

In the software, there are four main parts to the energy metrology software.

- The toolkit that contains a library of mostly mathematics routines
- The metrology code that is used for calculating metrology parameters
- The application code that is used for the host-processor functionality of the meter (for example, communication, LCD display, and RTC setup)
- The GUI that is used for calibration

5.2.1 Opening the Project

In the zip file download that is available with this application note, there are three executable files, where each executable corresponds to a different configuration option. To load software for a particular configuration, run the executable for the corresponding configuration. After running the executable, a zip file should be produced. Within the zip file contains the msp430-emeters-i2040 folder, which contains the source code for the selected configuration. [Figure 22](#) shows the contents of the msp430-emeters-i2040 folder.

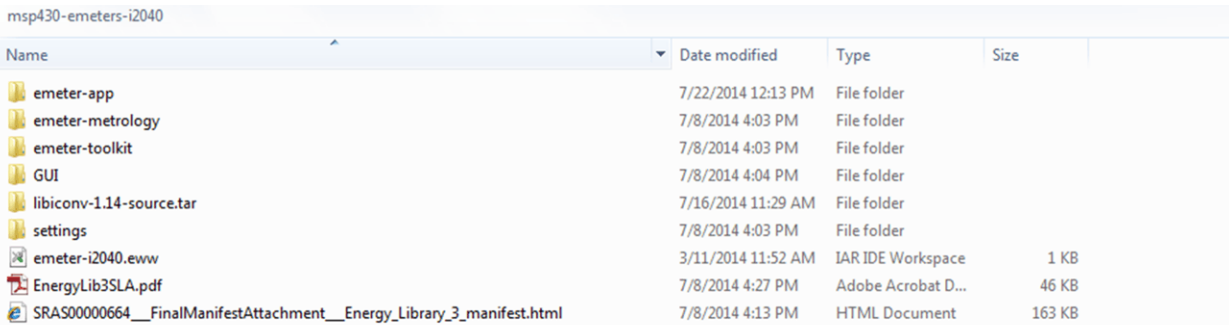

Name	Date modified	Type	Size
emeter-app	7/22/2014 12:13 PM	File folder	
emeter-metrology	7/8/2014 4:03 PM	File folder	
emeter-toolkit	7/8/2014 4:03 PM	File folder	
GUI	7/8/2014 4:04 PM	File folder	
libiconv-1.14-source.tar	7/16/2014 11:29 AM	File folder	
settings	7/8/2014 4:03 PM	File folder	
emeter-i2040.eww	3/11/2014 11:52 AM	IAR IDE Workspace	1 KB
EnergyLib3SLA.pdf	7/8/2014 4:27 PM	Adobe Acrobat D...	46 KB
SRA500000664_FinalManifestAttachment_Energy_Library_3_manifest.html	7/8/2014 4:13 PM	HTML Document	163 KB

Figure 22. msp430-emeters-i2040 Folder Structure

Within the emeter-app-i2041 folder in the emeter-app folder, the emeter-app-i2041.ewp project corresponds to the application code. Similarly, within the emeter-metrology-i2041 folder in the emeter-metrology folder, the emeter-metrology-i2041.ewp project corresponds to the portion of the code for metrology. Additionally, the folder emeter-toolkit-i2041 within emeter-toolkit has the corresponding toolkit project file emeter-toolkit-i2041.ewp. For first time use, it is recommended that all three projects be completely rebuilt by performing the following steps:

1. Open the IAR IDE.
2. Open the "emeter-i2040" workspace, which is located in the "msp430-emeters-i2040" folder.
3. Within IAR's workspace window, click the "Overview" tab to have a list view of all the projects.
4. Right-click the "emeter-toolkit-i2041" option in the workspace window and select Rebuild All, as shown in [Figure 23](#).
5. Right-click the "emeter-metrology-i2041" option in the workspace window and select Rebuild All, as shown in [Figure 24](#).
6. Within IAR's workspace window, click the "emeter-app-i2041" tab.
7. Within the workspace window, select "emeter-app-i2041", click Rebuild All as shown in [Figure 25](#), and then download this project onto the i2041.

NOTE: If any changes are made to any of the files in the toolkit project and the project is compiled, the metrology project must be recompiled. After recompiling the metrology project, the application project must then be recompiled. Similarly, if any changes are made to any of the files in the metrology project and the project is compiled, the application project must then be recompiled.

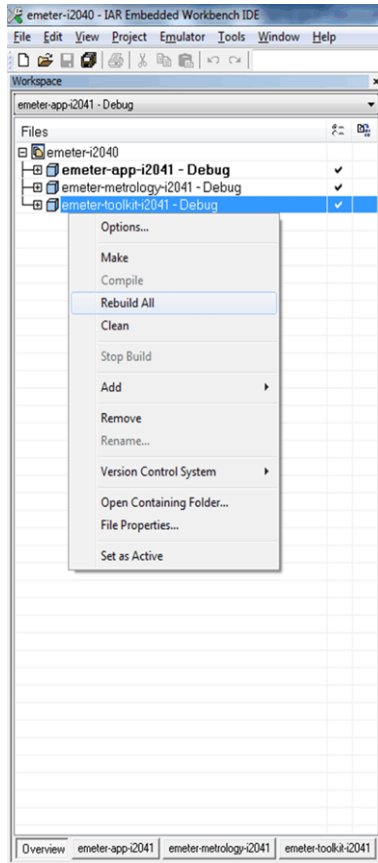

Figure 23. Toolkit Project Compilation

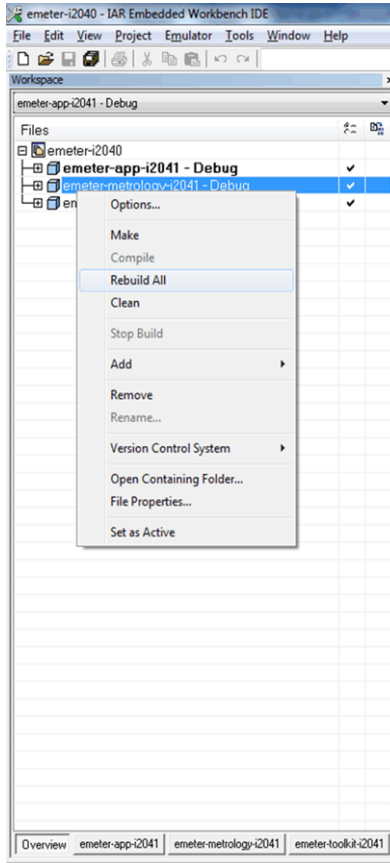

Figure 24. Metrology Project Compilation

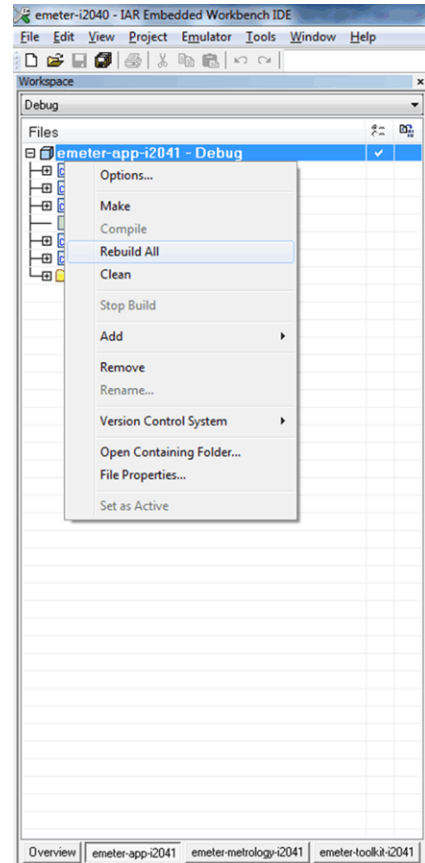

Figure 25. Application Project Compilation

6 Results and Calibration

6.1 GUI Execution

For this EVM, the same GUI can be used whether neutral-monitoring, common-voltage, or two-phase configurations are used. However, for the common-voltage configuration, a special BCPM GUI is recommended, which better displays the common-voltage configuration. This GUI can be found from the Branch Circuit Protection Monitor TI Design.

The fields in the GUI that are not applicable for a particular configuration are automatically disabled by being greyed out. For this section, the different GUI windows are shown for the two-phase configuration. The other configurations would have similar screens, except they would have different fields greyed out.

To run any of the GUIs:

1. Connect the EVM to a PC via an RS-232 cable.
2. Open "GUI" folder and open calibration-config.xml in a text editor.
3. Change the "port name" field within the "meter" tag to the COM port connected to the meter. In [Figure 26](#), this field is changed to COM7.

```

260 |         </correction>
261 |     </phase>
262 |     <temperature/>
263 |     <rtc/>
264 | </cal-defaults>
265 | <meter position="1">
266 |     <port name="com7" speed="9600"/>
267 | </meter>
268 | <reference-meter>
269 |     <port name="USB0::0x0A69::0x0835::A66200101281::INSTR"/>
270 |     <type id="chroma-66202"/>
271 |     <log requests="on" responses="on"/>
272 |     <scaling voltage="1.0" current="1.0"/>
273 | </reference-meter>

```

Figure 26. GUI Config File Changed to Communicate With Meter

- Run `calibrator.exe`, which is located in the GUI folder. If the COM port in `calibration-config.xml` was changed in the previous step to the com port connected to the EVM, the GUI opens (see Figure 27). If the GUI connects properly to the EVM, the top left button is green. If there are problems with connections or if the code is not configured correctly, the button is red. Click the green button to view the results.

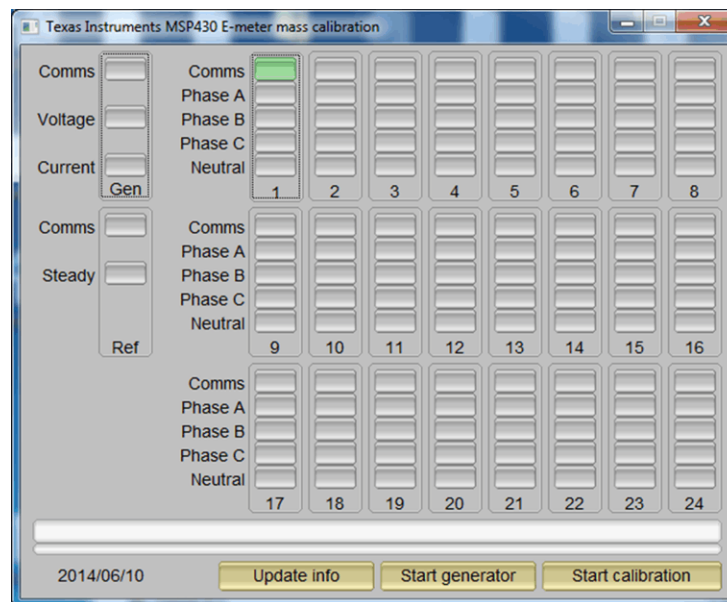

Figure 27. GUI Startup Window

6.2 View Results

Click on the green button to open the results window (see Figure 28). The Power factor values have a trailing "L" or "C" to indicate an inductive or capacitive load, respectively.

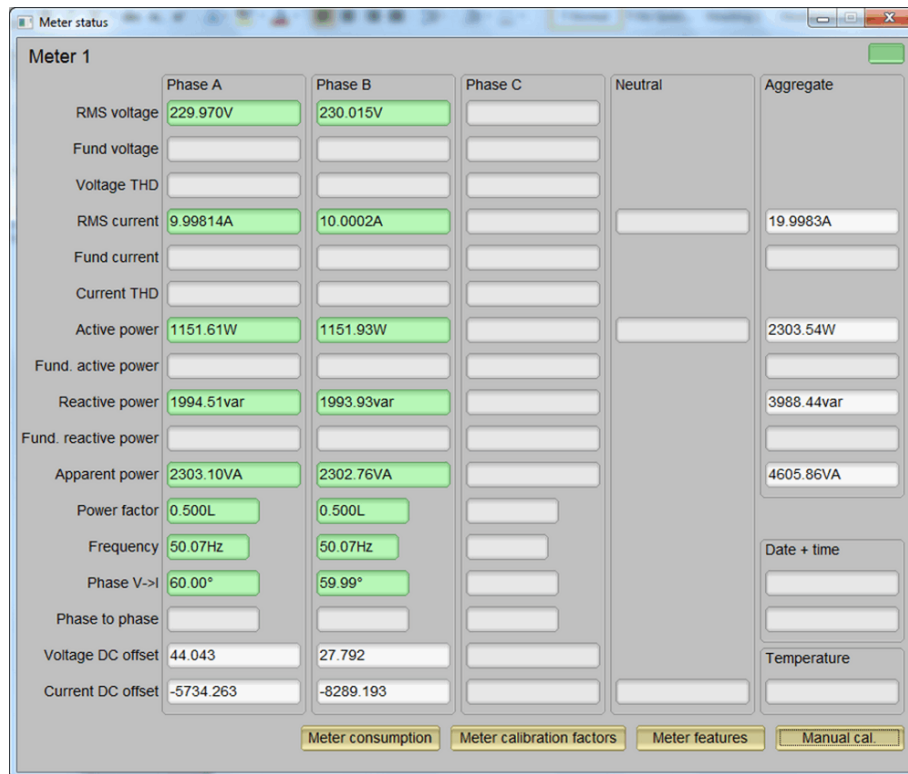

Figure 28. Results Window

Click the "Meter Consumption" button in the results window to open the meter events and consumption window (see Figure 29). This window shows the total energy consumption readings and the sag and swell logs.

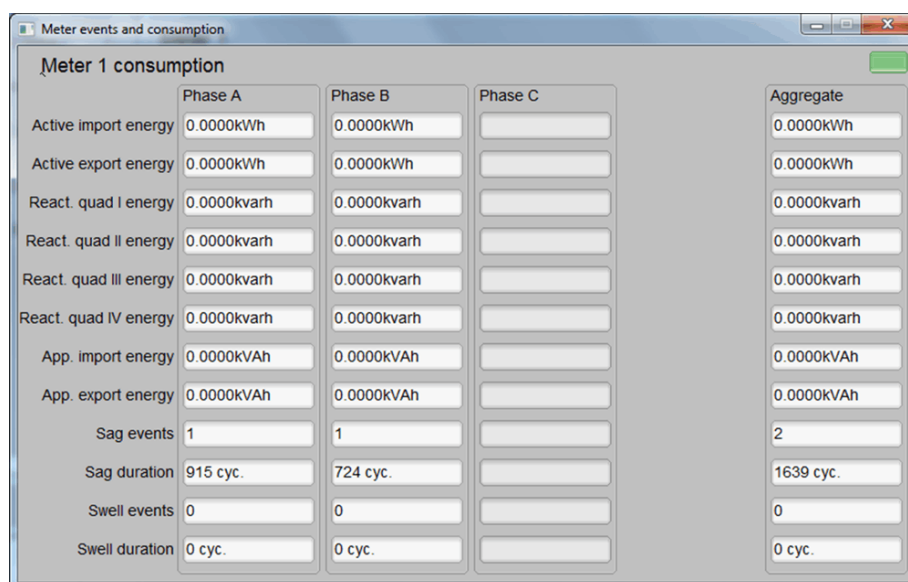

Figure 29. Meter Events and Consumption Window

6.3 Calibration

Calibration is key to any meter's performance, and it is absolutely necessary for every meter to go through this process. Initially, every meter exhibits different accuracies due to silicon-to-silicon differences, sensor accuracies, and other passive tolerances. To nullify the effects of these differences, every meter must be calibrated. For calibration to be performed accurately, an accurate ac test source and a reference meter must be available. The source should be able to generate any desired voltage, current, and phase shift (between V and I). To calculate errors in measurement, the reference meter acts as an interface between the source and the meter that is being calibrated. This section describes a simple and effective method of calibration of this EVM.

The GUI that is used for viewing results can also be used to calibrate the EVM. During calibration, parameters called calibration factors are modified in software to give least error in measurement. For this meter, there are six main calibration factors for each phase: voltage scaling factor, voltage ac offset, current scaling factor, current ac offset, power scaling factor, and the phase compensation factor. The voltage, current, and power scaling factors translate measured quantities in metrology software to real-world values represented in volts, amps, and watts, respectively. The voltage ac offset and current ac offset are used to eliminate the effect of Additive White Gaussian Noise associated with each channel. This noise is orthogonal to everything except itself. As a result, it is present only when calculating RMS voltages and currents. The last calibration factor is the phase compensation factor, which is used to compensate any phase shifts introduced by the current sensors and other passives. Note that the voltage, current, and power calibration factors are independent of each other. Therefore, calibrating voltage does not affect the readings for RMS current or power.

When the meter software is flashed with the code (available in the zip file), default calibration factors are loaded into these calibration factors (see Section 4.4.1 for the macros associated with each calibration factor). These values will be modified via the GUI during calibration. The calibration factors are stored in INFO_MEM, and therefore, would remain the same if the meter is restarted. However, if the software configuration selection is changed and the meter is re-flashed during debug, the calibration factors are replaced and the meter must be recalibrated. One way to save the calibration values is by clicking on the "Meter calibration factors" button shown in Figure 30. The meter calibration factors window displays the latest values and this could be used to directly replace the macro definition of these factors in the source code. The "Voltage", "Voltage ac off", "Current", "Current ac offset", and "Active Power" calibration factors shown in the calibration factors window could be copied directly into the corresponding macros in the source code. However, for phase correction, a conversion must be made from microseconds to register units because the software's phase correction parameters are in units of modulation clock cycles instead of microseconds. To convert the value displayed by the GUI into a value that can be used by the associated macro in emeter-template, multiply the "Phase correction" variable on the GUI by 8.192000, round the resulting number to the nearest integer, and then right-shift by 3.

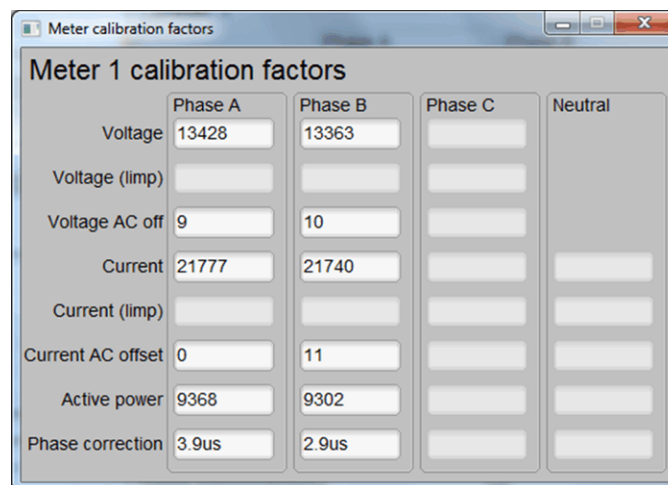

Figure 30. Calibration Factors Window

Calibrating any of the scaling factors is referred to as gain correction. Calibrating any of the phase compensation factors is referred to as phase correction. Calibrating the offset is referred to as offset calibration. For the entire calibration process, the ac test source must be on, meter connections must be made as shown in [Section 5.1.1](#), and the energy pulses must be connected to the reference meter.

6.3.1 Gain Calibration

Usually gain correction for voltage and current can be done simultaneously for all phases. However, accuracy (%) from the reference meter for each individual phase is needed for accurate gain correction of active power. Also, when performing active power calibration for any given phase, any other phases must be turned off. Typically, switching off only the currents is good enough to disable a phase.

6.3.1.1 Voltage and Current Gain Calibration

To calibrate the voltage and current readings:

1. Connect the GUI to view results for voltage, current, active power, and the other metering parameters.
2. Configure the test source to supply the desired voltage and current for all phases. Make sure that these are the voltage and current calibration points with a zero-degree phase shift between each phase's voltage and current. For example: 230 V, 10 A, 0° (PF = 1). Typically, these values are the same for every phase.
3. Click the "Manual cal." button in the Results window (see [Figure 28](#)) to open the window shown [Figure 31](#).

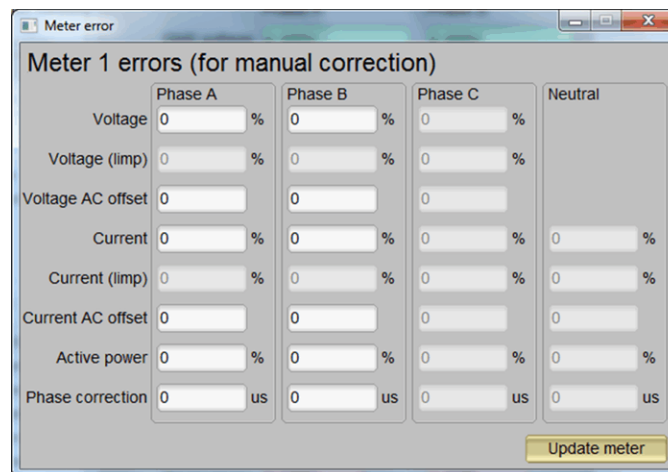

Figure 31. Manual Calibration Window

4. Calculate the correction values for each voltage and current. The correction values that need to be entered for the voltage and current fields are calculated by:

$$\text{Correction}(\%) = \left(\frac{\text{value}_{\text{observed}}}{\text{value}_{\text{desired}}} - 1 \right) \times 100$$

where

- $\text{value}_{\text{observed}}$ is the value measured by the TI meter
- $\text{value}_{\text{desired}}$ is the calibration point configured in the ac test source (10)

5. After calculating Correction(%) for all voltages and currents, input these values as is (±) for the fields "Voltage" and "Current" for the corresponding phases.
6. Click Update meter and the observed values for the voltages and currents on the GUI settle to the desired voltages and currents.

6.3.1.2 Active Power Gain Calibration

Note that this example is for one phase. Repeat these steps for any other phases.

After performing gain correction for voltage and current, gain correction for active power must be done. Gain correction for active power is different from voltage and current correction. Although, conceptually, calculating Correction(%) using Step 4 with Active power readings (displayed on the ac test source) can be done for active power, it is not the most accurate method and should be avoided for energy calibration. For these configurations, the best option is to find the Correction(%) directly from the reference meter's measurement error of the active power. This error is obtained by feeding energy pulses to the reference meter. This error must be recorded for each phase individually with the other phases disabled.

To perform active power calibration:

1. Turn off the meter and connect the meter's energy pulse output to the reference meter. Configure the reference meter to measure the active power error based on these pulse inputs.
2. Turn on the ac test source.
3. Repeat Steps 1 to 3 from [Section 6.3.1.1](#) with the identical voltages, currents, and 0° phase shifts that were used for the voltage and current gain calibration.
4. Disable the other phases that are not currently being calibrated by setting the current of these phases to 0 A.
5. Obtain the percentage error in measurement from the reference meter. Note that this value may be negative.
6. Enter the error obtained in the above step into the "Active" field under the corresponding phase in the GUI window. This error is already the Correction(%) value and does not need to be calculated.
7. Click "Update meter" and the error values on the reference meter settle to a value close to zero.

6.3.2 Phase Correction

Note that this example is for a given phase. Repeat these steps for other phases.

After performing power gain correction, phase calibration must be performed. Similar to active power gain calibration, to perform phase correction on one phase, the other phases must be disabled. To perform phase correction calibration, perform the following steps:

1. If the ac test source has been turned OFF or reconfigured, perform steps 1 through 3 from the voltage and current gain section ([Section 6.3.1.1](#)) using the identical voltages and currents used in that section.
2. Disable all other phases that are not currently being calibrated by setting the current of these phases to 0 A.
3. Modify only the phase-shift of the calibrated phase to a nonzero value; typically, +60° is chosen. The reference meter now displays a different percentage error for active power measurement. Note that this value may be negative.
4. Using the percentage error readings provided by your reference meter (denoted as %_{error} in the following equations), the phase shift supplied by your source meter (denoted as φ_{desired}), and the line frequency fed into the meter (denoted as f_{Mains}), calculate the correction factor (in units of microseconds) by using [Equation 11](#). For these equations, note that φ_{desired} and φ_{error} must be in units of degrees while f_{Mains} must be in units of Hertz.

$$\varphi_{\text{error}} = \arccos\left(\left(\frac{\%_{\text{error}}}{100} + 1\right) \times \cos(\varphi_{\text{desired}})\right) - \varphi_{\text{desired}}$$

$$\text{correction} = \frac{-\varphi_{\text{error}} \times 10^6}{f_{\text{Mains}} \times 360} \quad (11)$$

5. Enter the calculated correction into the "Phase" field for the phase that is being calibrated.
6. Click "Update meter".
7. If this error is not close to zero, or if it is unacceptable, fine tune the phase correction by following these steps:
 - (a) Enter a small value as an update for the "Phase" field for the phase that is being calibrated.

Usually, a small positive or negative integer should be entered to bring the error close to zero. Additionally, for a phase shift greater than 0 (for example, +60°), a positive (negative) error would require a positive (negative) number as correction.

- (b) Click Update meter and monitor the error values on the reference meter.
- (c) If this measurement error (%) is not accurate enough, fine tune by incrementing or decrementing by a value of 1 based on steps (a) and (b).

Note: When the error is very close to zero, changing the fine-tuning value by 1 can result in the error oscillating on either side of zero. Select the value that has the smallest absolute error.

- (d) Change the phase to -60° and determine if this error is still acceptable. Ideally, errors should be symmetric for same phase shift on lag and lead conditions.

After performing phase correction, calibration is complete for one phase.

Note that the gain calibration and phase calibration are completed in sequence for each phase before moving on to other phases. These two procedures must be repeated for each phase, unlike voltage and current calibration.

This completes calibration of voltage, current, and power. View the new calibration factors by clicking the Meter Calibration factors button of the GUI metering results window (see [Figure 32](#)).

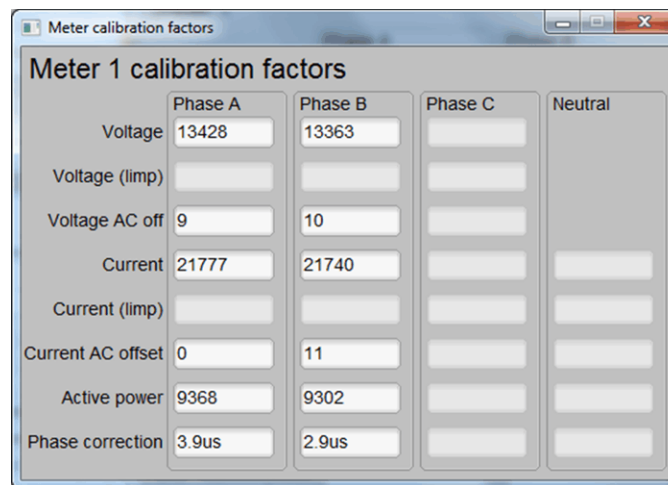

Figure 32. Calibration Factors Window

The configuration of the meter can also be viewed by clicking Meter features to open the screen shown in [Figure 33](#) (this is only an example).

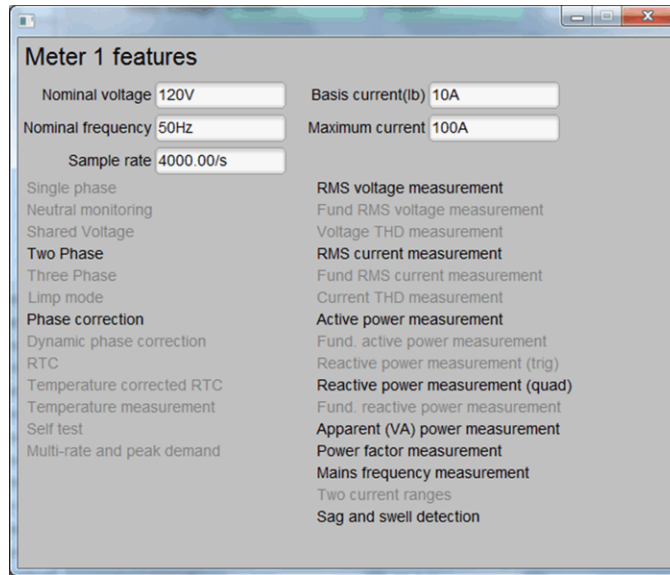

Figure 33. Meter Features Window

6.4 Metrology Results

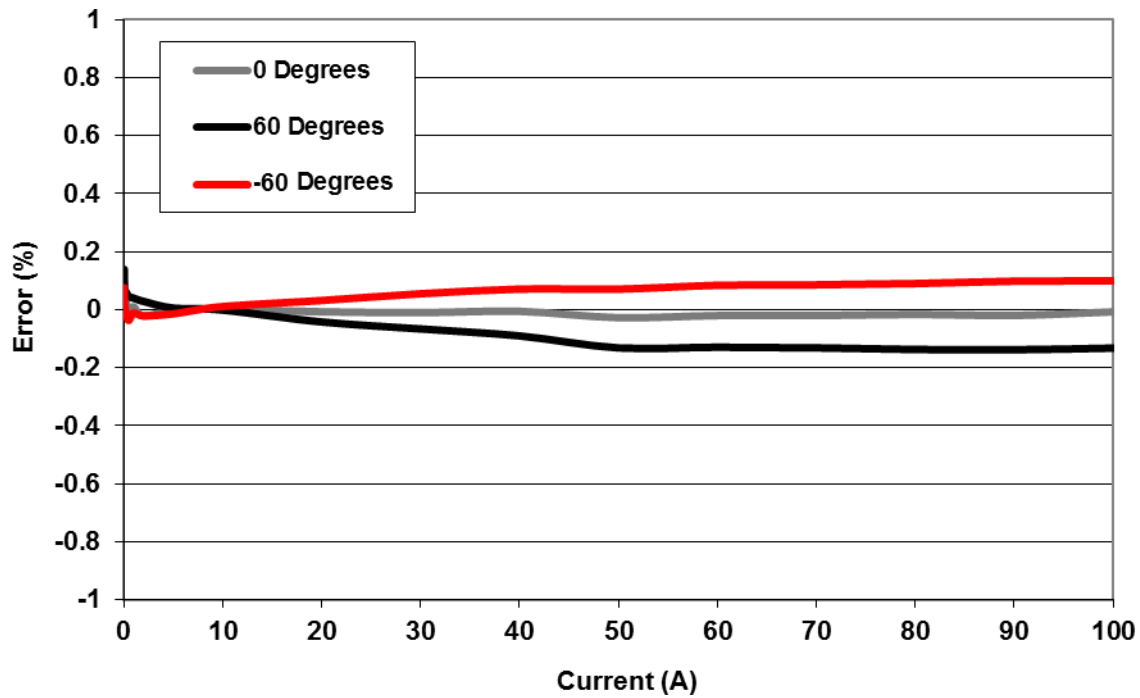

Figure 34. Channel A Active Energy Measurement Error, Common-Voltage

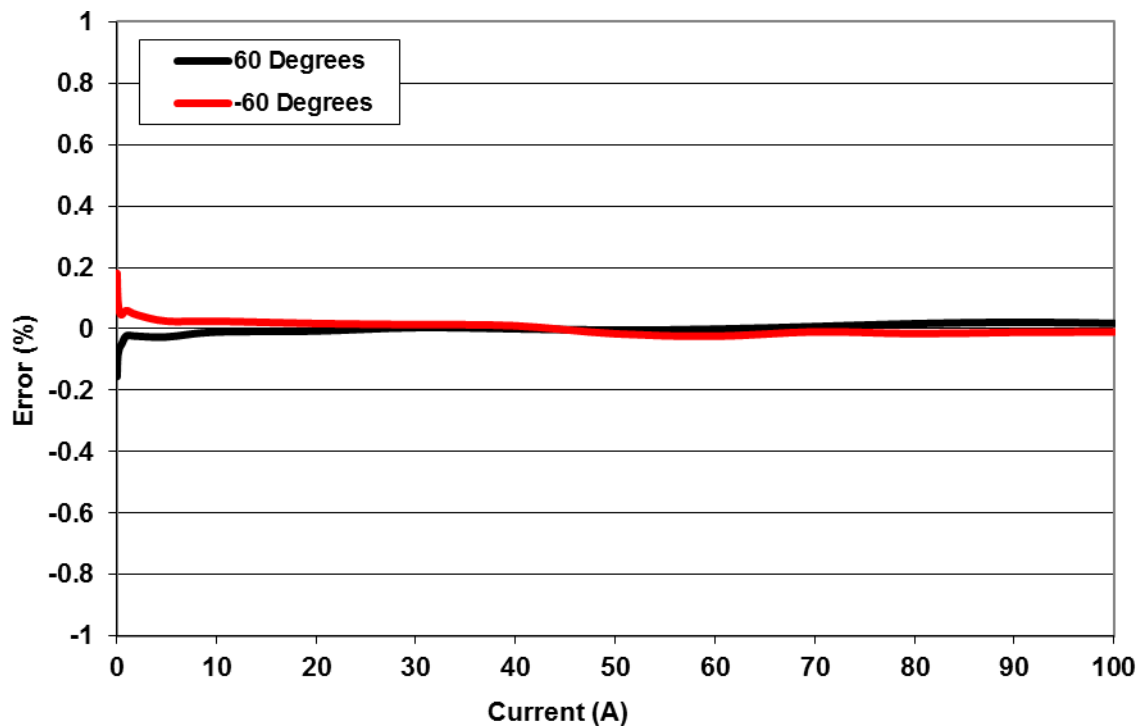

Figure 35. Channel A Reactive Energy Measurement Error, Common-Voltage

Table 2. Channel A Energy Measurement Error, Common-Voltage

Current (A)	Active Power Error (%)			Reactive Power Error (%)	
	0°	60°	-60°	60°	-60°
0.05	0.041	0.139	0.076	-0.155	0.181
0.1	0.008	0.068	0.021	-0.097	0.109
0.25	0.024	0.0605	-0.013	-0.065	0.058
0.5	-0.007	0.046	-0.037	-0.05	0.046
1	0.0097	0.04	-0.011	-0.022	0.06
2	-0.0215	0.029	-0.021	-0.0233	0.0463
5	-0.003	0.006	-0.014	-0.026	0.0253
10	0.0025	-0.001	0.011	-0.01	0.025
20	-0.007	-0.042	0.032	-0.0067	0.0177
30	-0.01	-0.066	0.0553	0.0043	0.014
40	-0.0055	-0.09	0.0713	0.00043	0.0103
50	-0.0273	-0.1313	0.071	-0.004	-0.0157
60	-0.02	-0.1293	0.0843	-0.0007	-0.024
70	-0.02	-0.1315	0.086	0.0077	-0.0093
80	-0.0163	-0.137	0.0903	0.017	-0.0153
90	-0.0197	-0.1377	0.0983	0.022	-0.011
100	-0.007	-0.1323	0.0993	0.018	-0.0097

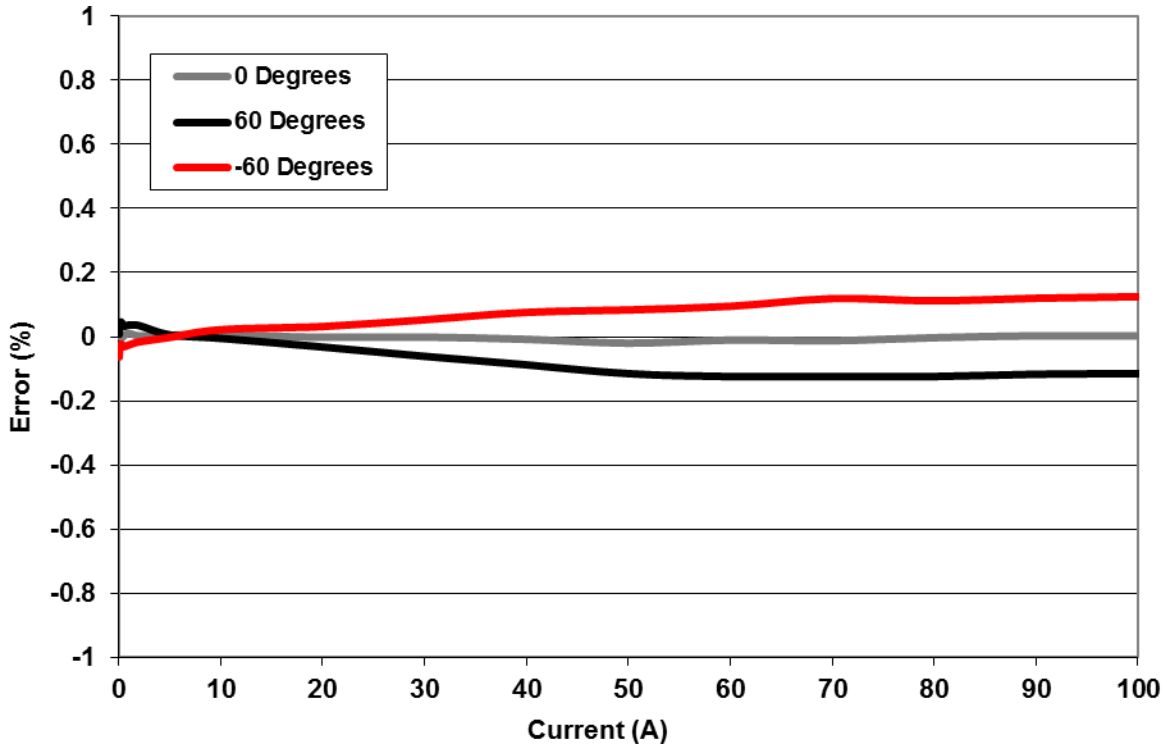

Figure 36. Channel B Active Energy Measurement Error, Common-Voltage

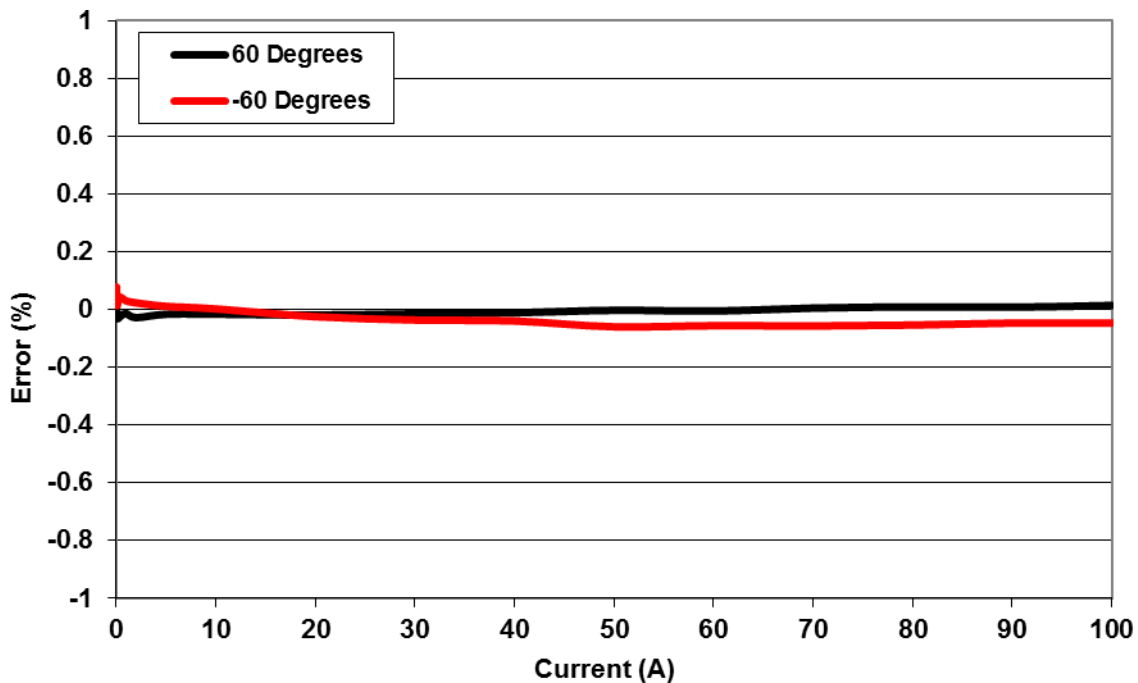

Figure 37. Channel B Reactive Energy Measurement Error, Common-Voltage

Table 3. Channel B Energy Measurement Error, Common-Voltage

Current (A)	Active Power Error (%)			Reactive Power Error (%)	
	0°	60°	-60°	60°	-60°
0.05	0.022	0.008	-0.063	0.013	0.078
0.1	0.013	0.0405	-0.032	-0.031	0.014
0.25	-0.003	0.046	-0.022	-0.03	0.041
0.5	0.0025	0.033	-0.031	-0.022	0.042
1	0.0107	0.0367	-0.0255	-0.014	0.0303
2	0.003	0.035	-0.016	-0.028	0.0233
5	0.005	0.006	-0.002	-0.0165	0.0113
10	0.0055	-0.005	0.022	-0.016	0.0023
20	-0.0017	-0.032	0.032	-0.0193	-0.0247
30	-0.001	-0.061	0.053	-0.0147	-0.0363
40	-0.008	-0.0875	0.076	-0.0113	-0.0397
50	-0.02	-0.115	0.0837	-0.0027	-0.0597
60	-0.0103	-0.1243	0.095	-0.0053	-0.056
70	-0.0123	-0.1237	0.119	0.005	-0.057
80	-0.003	-0.124	0.112	0.009	-0.054
90	0.003	-0.117	0.12	0.008	-0.047
100	0.0023	-0.115	0.125	0.014	-0.0467

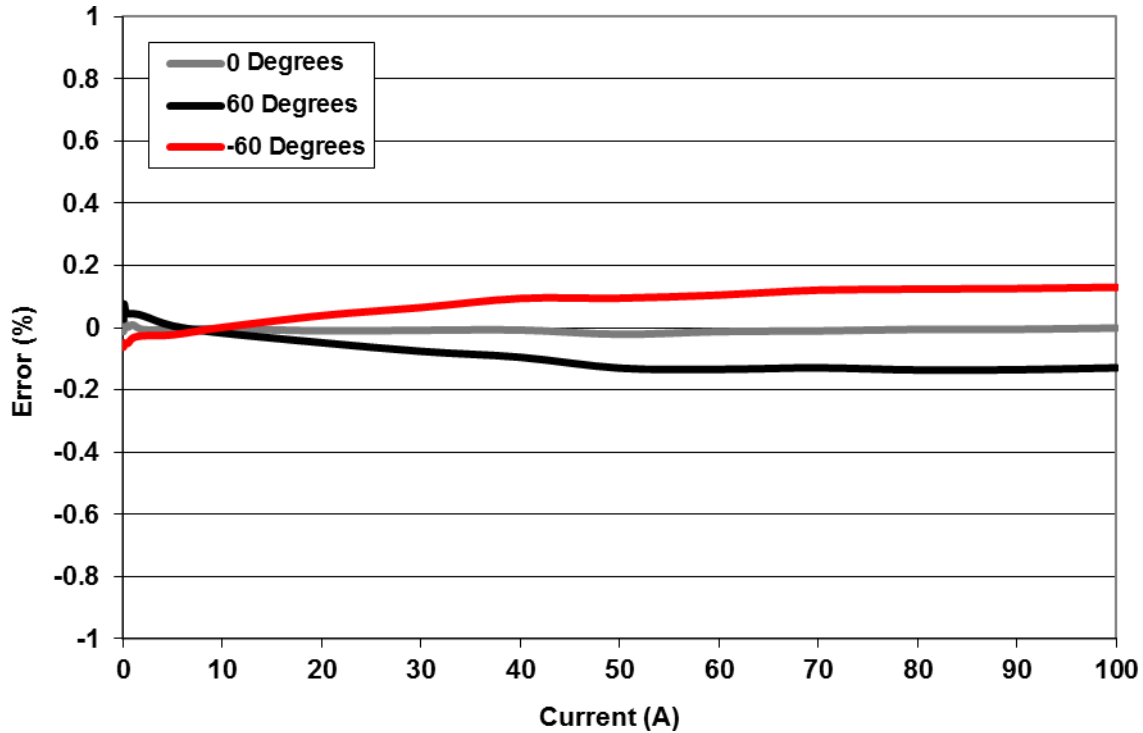

Figure 38. Channel C Active Energy Measurement Error, Common-Voltage

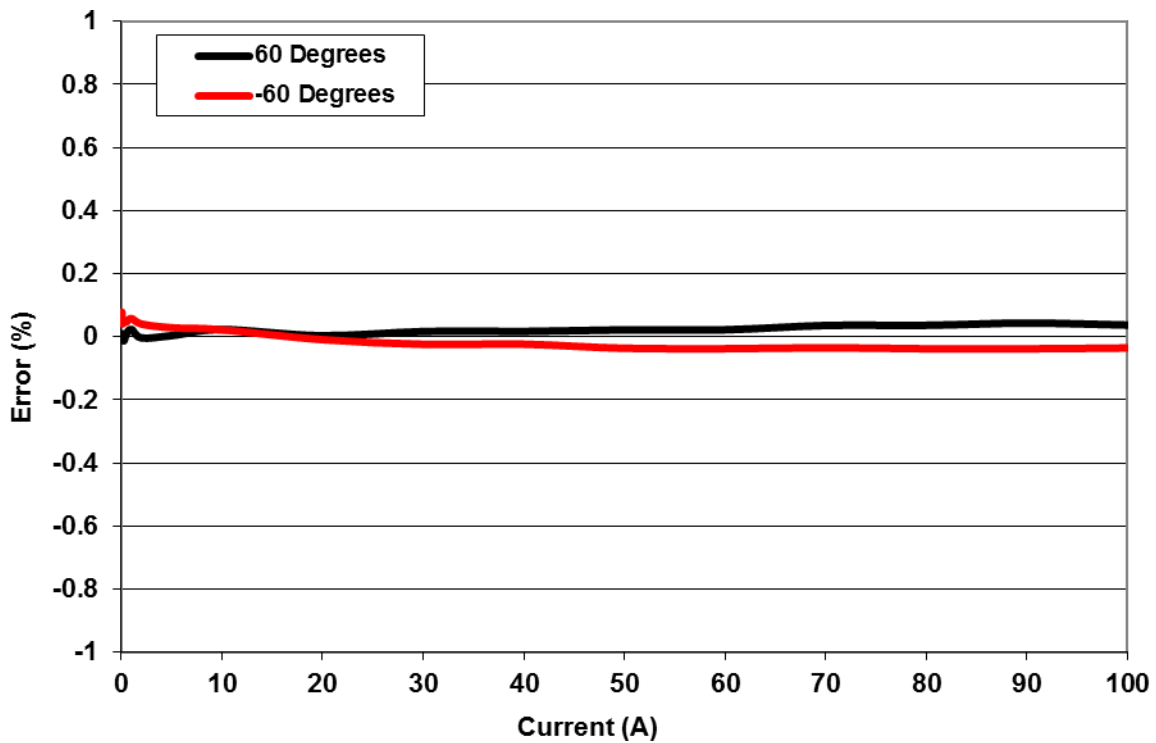

Figure 39. Channel C Reactive Energy Measurement Error, Common-Voltage

Table 4. Channel C Energy Measurement Error, Common-Voltage

Current (A)	Active Power Error (%)			Reactive Power Error (%)	
	0°	60°	-60°	60°	-60°
0.05	-0.012	0.027	-0.062	-0.002	0.078
0.1	0.018	0.076	-0.049	0.01	0.041
0.25	0.011	0.054	-0.051	-0.013	0.045
0.5	0.002	0.045	-0.05	0.009	0.047
1	0.0093	0.0453	-0.0327	0.0233	0.0577
2	-0.006	0.0387	-0.0257	-0.0037	0.0403
5	-0.0057	0.006	-0.023	0.0035	0.0287
10	-0.0033	-0.017	0.001	0.0227	0.022
20	-0.01	-0.048	0.039	0.0033	-0.0093
30	-0.0083	-0.076	0.065	0.0167	-0.024
40	-0.0075	-0.095	0.0943	0.0167	-0.0237
50	-0.021	-0.13	0.095	0.0217	-0.0367
60	-0.0123	-0.1337	0.105	0.022	-0.038
70	-0.0103	-0.129	0.121	0.0357	-0.035
80	-0.0053	-0.136	0.124	0.0363	-0.0383
90	-0.005	-0.135	0.126	0.0433	-0.0383
100	-0.001	-0.129	0.13	0.037	-0.0357

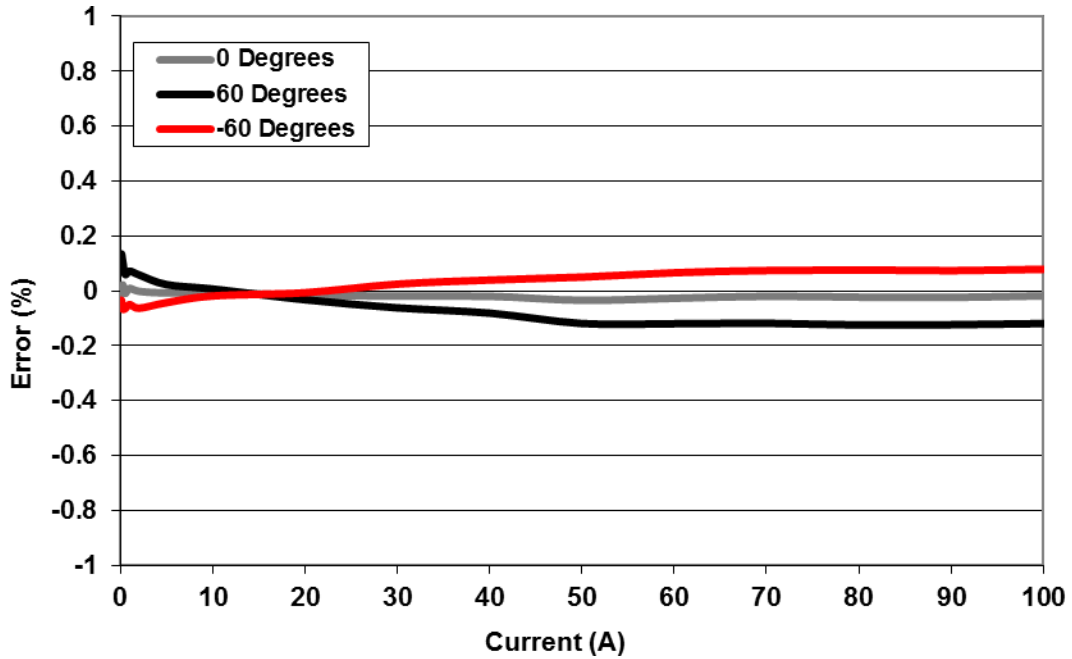

Figure 40. Cumulative Phase Active Energy Measurement Error, Two-Phase

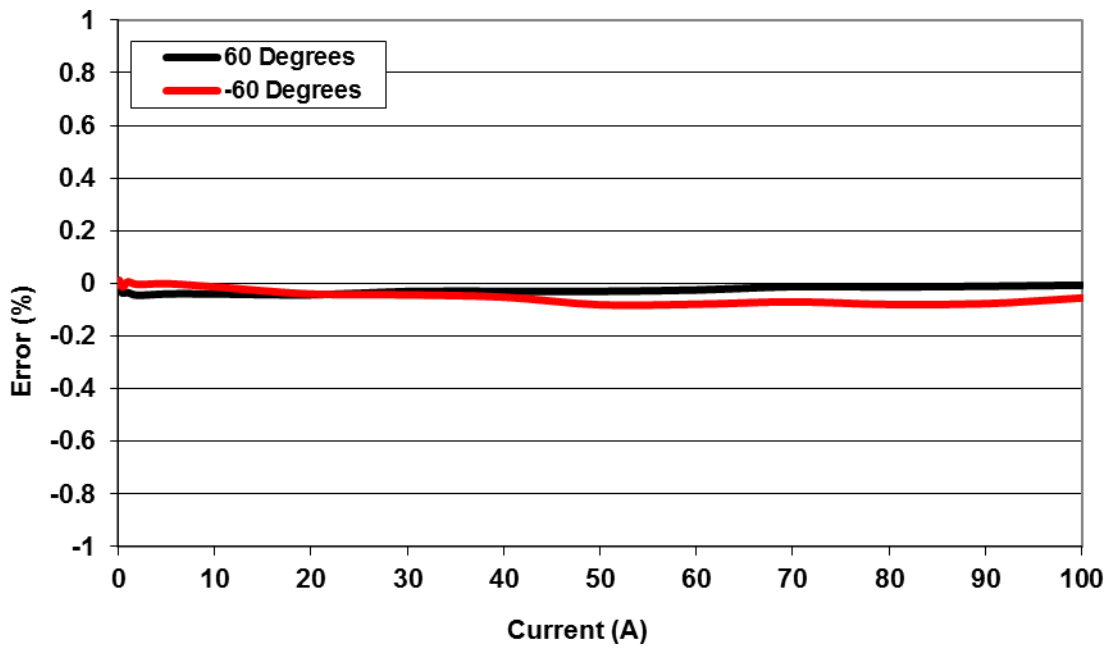

Figure 41. Cumulative Phase Reactive Energy Measurement Error, Two-Phase

Table 5. Cumulative Phase Energy Measurement Error, Two-Phase

Current (A)	Active Power Error (%)			Reactive Power Error (%)	
	0°	60°	-60°	60°	-60°
0.05	0	0.107	-0.047	0	-0.006
0.1	-0.012	0.135	-0.034	0.01	0.011
0.25	0.022	0.104	-0.066	-0.029	0
0.5	-0.009	0.06	-0.065	-0.037	-0.014
1	0.009	0.072	-0.05	-0.035	0.006
2	-0.00166667	0.05833333	-0.06333333	-0.045	-0.004
5	-0.00766667	0.02266667	-0.043	-0.04	-0.001
10	-0.00566667	0.00666667	-0.01866667	-0.04	-0.013
20	-0.016	-0.03233333	-0.00666667	-0.043	-0.04
30	-0.019	-0.062	0.02466667	-0.0307	-0.0433
40	-0.02	-0.081	0.03933333	-0.03	-0.052
50	-0.03433333	-0.119	0.05	-0.03	-0.081
60	-0.027	-0.12	0.066	-0.025	-0.079
70	-0.02	-0.118333	0.074	-0.012	-0.07
80	-0.023	-0.124333	0.0763333	-0.0135	-0.08
90	-0.024	-0.123333	0.0736667	-0.011	-0.077
100	-0.0183333	-0.119333	0.0786667	-0.0067	-0.055

7 Schematics

The following pages show the schematics for the EVM430-i2040.

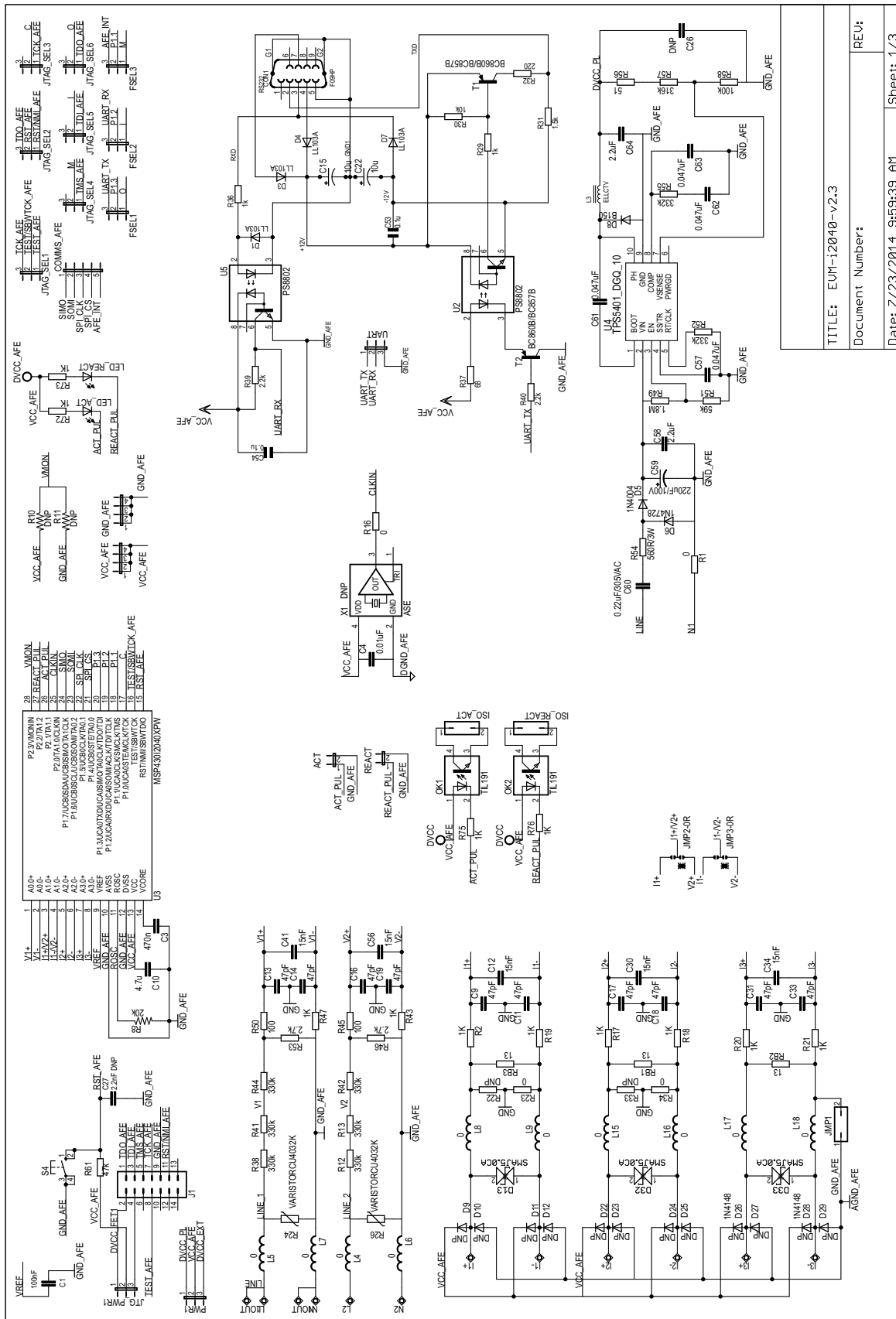

Figure 42. Schematics, 1 of 3

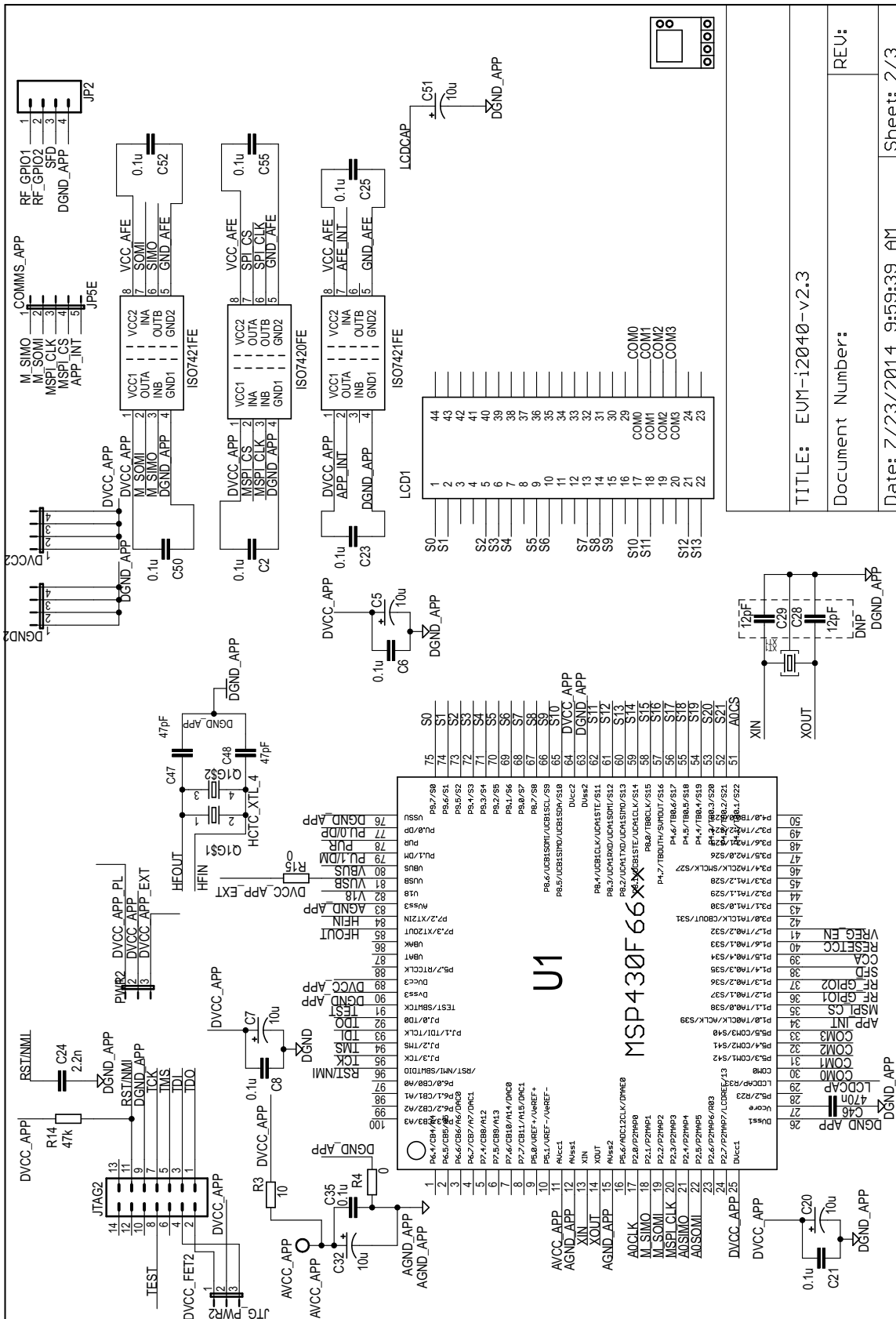

Figure 43. Schematics, 2 of 3

Revision History

Changes from Original (August 2014) to A Revision	Page
• Changed download location of source code.....	1

NOTE: Page numbers for previous revisions may differ from page numbers in the current version.

IMPORTANT NOTICE

Texas Instruments Incorporated and its subsidiaries (TI) reserve the right to make corrections, enhancements, improvements and other changes to its semiconductor products and services per JESD46, latest issue, and to discontinue any product or service per JESD48, latest issue. Buyers should obtain the latest relevant information before placing orders and should verify that such information is current and complete. All semiconductor products (also referred to herein as "components") are sold subject to TI's terms and conditions of sale supplied at the time of order acknowledgment.

TI warrants performance of its components to the specifications applicable at the time of sale, in accordance with the warranty in TI's terms and conditions of sale of semiconductor products. Testing and other quality control techniques are used to the extent TI deems necessary to support this warranty. Except where mandated by applicable law, testing of all parameters of each component is not necessarily performed.

TI assumes no liability for applications assistance or the design of Buyers' products. Buyers are responsible for their products and applications using TI components. To minimize the risks associated with Buyers' products and applications, Buyers should provide adequate design and operating safeguards.

TI does not warrant or represent that any license, either express or implied, is granted under any patent right, copyright, mask work right, or other intellectual property right relating to any combination, machine, or process in which TI components or services are used. Information published by TI regarding third-party products or services does not constitute a license to use such products or services or a warranty or endorsement thereof. Use of such information may require a license from a third party under the patents or other intellectual property of the third party, or a license from TI under the patents or other intellectual property of TI.

Reproduction of significant portions of TI information in TI data books or data sheets is permissible only if reproduction is without alteration and is accompanied by all associated warranties, conditions, limitations, and notices. TI is not responsible or liable for such altered documentation. Information of third parties may be subject to additional restrictions.

Resale of TI components or services with statements different from or beyond the parameters stated by TI for that component or service voids all express and any implied warranties for the associated TI component or service and is an unfair and deceptive business practice. TI is not responsible or liable for any such statements.

Buyer acknowledges and agrees that it is solely responsible for compliance with all legal, regulatory and safety-related requirements concerning its products, and any use of TI components in its applications, notwithstanding any applications-related information or support that may be provided by TI. Buyer represents and agrees that it has all the necessary expertise to create and implement safeguards which anticipate dangerous consequences of failures, monitor failures and their consequences, lessen the likelihood of failures that might cause harm and take appropriate remedial actions. Buyer will fully indemnify TI and its representatives against any damages arising out of the use of any TI components in safety-critical applications.

In some cases, TI components may be promoted specifically to facilitate safety-related applications. With such components, TI's goal is to help enable customers to design and create their own end-product solutions that meet applicable functional safety standards and requirements. Nonetheless, such components are subject to these terms.

No TI components are authorized for use in FDA Class III (or similar life-critical medical equipment) unless authorized officers of the parties have executed a special agreement specifically governing such use.

Only those TI components which TI has specifically designated as military grade or "enhanced plastic" are designed and intended for use in military/aerospace applications or environments. Buyer acknowledges and agrees that any military or aerospace use of TI components which have **not** been so designated is solely at the Buyer's risk, and that Buyer is solely responsible for compliance with all legal and regulatory requirements in connection with such use.

TI has specifically designated certain components as meeting ISO/TS16949 requirements, mainly for automotive use. In any case of use of non-designated products, TI will not be responsible for any failure to meet ISO/TS16949.

Products

Audio	www.ti.com/audio
Amplifiers	amplifier.ti.com
Data Converters	dataconverter.ti.com
DLP® Products	www.dlp.com
DSP	dsp.ti.com
Clocks and Timers	www.ti.com/clocks
Interface	interface.ti.com
Logic	logic.ti.com
Power Mgmt	power.ti.com
Microcontrollers	microcontroller.ti.com
RFID	www.ti-rfid.com
OMAP Applications Processors	www.ti.com/omap
Wireless Connectivity	www.ti.com/wirelessconnectivity

Applications

Automotive and Transportation	www.ti.com/automotive
Communications and Telecom	www.ti.com/communications
Computers and Peripherals	www.ti.com/computers
Consumer Electronics	www.ti.com/consumer-apps
Energy and Lighting	www.ti.com/energy
Industrial	www.ti.com/industrial
Medical	www.ti.com/medical
Security	www.ti.com/security
Space, Avionics and Defense	www.ti.com/space-avionics-defense
Video and Imaging	www.ti.com/video

TI E2E Community

e2e.ti.com